

## ÜNİVERSAL TORNA AYNALARI SALGI DEĞERLERİ

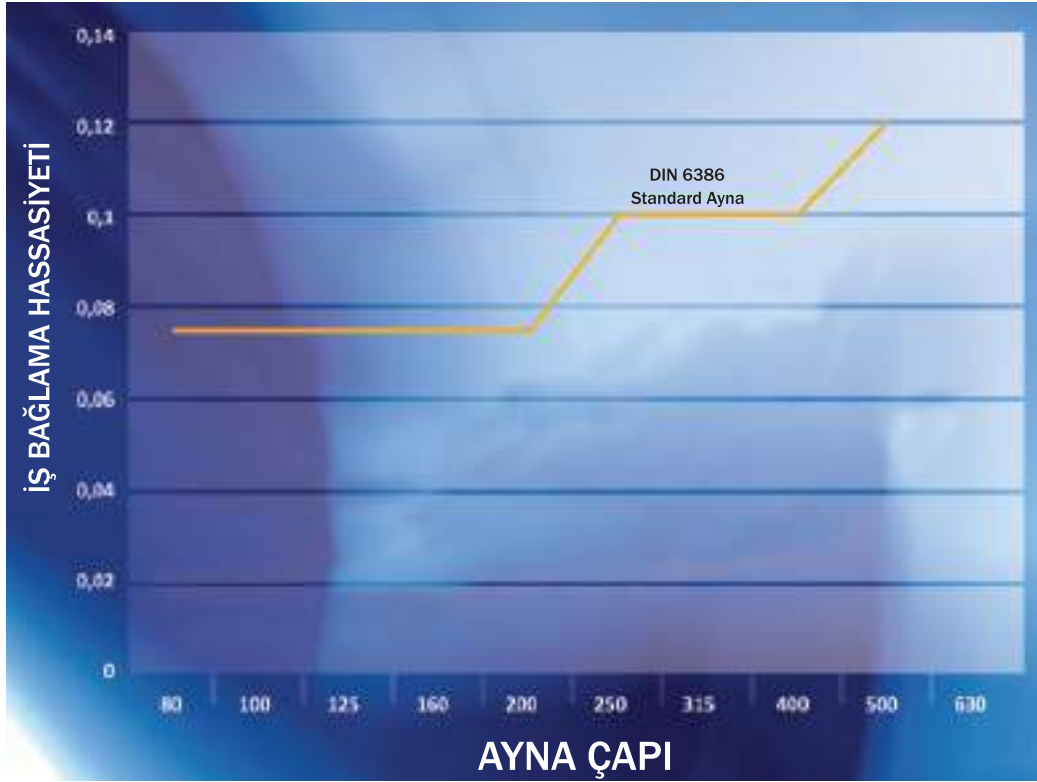
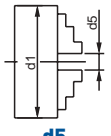
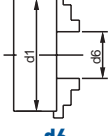
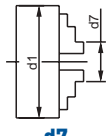
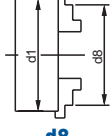
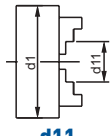
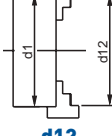

## ÜNİVERSAL TORNA AYNALARI İŞ BAĞLAMA KAPASİTELERİ

AYNA ÇAPI (mm)	DÜZ AYAK İLE				TERS AYAK İLE	
	 d5 min.	 d6 max.	 d7 min.	 d8 max.	 d11 min.	 d12 max.
80	2	22	25	70	22	63
100	2	30	30	90	30	80
125	3	40	38	125	38	110
160	3	55	50	160	55	145
200	4	85	65	200	65	200
250	6	110	80	250	90	250
315	10	140	95	315	100	315
400	15	210	120	400	120	400
500	25	280	150	500	150	500
630	50	350	170	630	170	630

## 3 AYAKLI ÜNİVERSAL TORNA AYNASI

TİP K11

## ÖZELLİKLER

- 3 AYAKLI MERKEZİ SIKMALI ÜNİVERSAL TORNA AYNASI
- DÖKÜM GÖVDELİDİR
- ÜNİVERSAL TORNA TEZGAHLARINDA FENER MİLİNE FLANŞ İLE BAĞLANIR
- FREZELERDE, DİVİZÖRLERDE VE TABLALARDA KULLANILIR

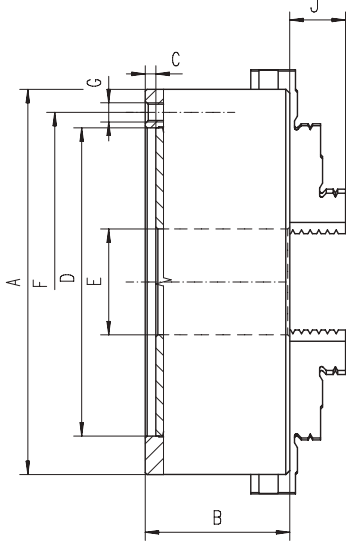

KOD	CHAR.80/3	CHAR.100/3	CHAR.125/3	CHAR.160/3	CHAR.200/3	CHAR.250/3	CHAR.315/3	CHAR.400/3	CHAR.500/3	CHAR.630/3
ØA	80	100	125	160	200	250	315	400	500	630
B	50	55	58	65	75	80	90	100	115	133,5
C	3,5	3,5	4	5	5	5	6	6	6	7
D H7	55	72	95	130	165	206	260	340	440	560
E	16	22	30	40	65	80	100	130	210	270
F	66	84	108	142	180	226	285	368	465	595
G	3xM6	3xM8	3xM8	6xM8	3xM10	3xM12	3xM16	3xM16	6xM16	6xM16
J	16	19,5	26	30	34	40	57	72	87	84,5
KG	1,9	3,2	5	8,8	15,5	25,7	47	71	119	215
<b>FİYAT USD</b>										

STANDART AKSESUARLAR	1 TAKIM DÜZ AYAK	1 TAKIM TERS AYAK	1 ADET ANAHTAR	FLANŞ BAĞLAMA CİVATASI	İSTEĞE BAĞLI AKSESUARLAR	1 TAKIM YUMUŞAK AYAK	AYNA BAĞLAMA FLANŞI

## 4 AYAKLI ÜNİVERSAL TORNA AYNASI

TİP K12

## ÖZELLİKLER

- 4 AYAKLI MERKEZİ SIKMALI ÜNİVERSAL TORNA AYNASI
- DÖKÜM GÖVDELİDİR
- ÜNİVERSAL TORNA TEZGAHLARINDA FENER MİLİNE FLANŞ İLE BAĞLANIR
- FREZELERDE, DİVİZÖRLERDE VE TABLALARDA KULLANILIR

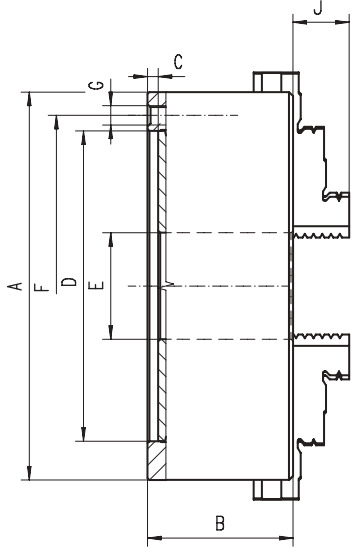

KOD	CHAR.80/4	CHAR.100/4	CHAR.125/4	CHAR.160/4	CHAR.200/4	CHAR.250/4	CHAR.315/4	CHAR.400/4	CHAR.500/4	CHAR.630/4
ØA	80	100	125	160	200	250	315	400	500	630
B	50	55	58	65	75	80	90	100	115	133,5
C	3,5	3,5	4	5	5	5	6	6	6	7
D H7	55	72	95	130	165	206	260	340	440	560
E	16	22	30	40	65	80	100	130	210	270
F	66	84	108	142	180	226	285	368	465	595
G	4xM6	3xM8	3xM8	6xM8	3XxM10	3xM12	3xM16	3xM16	6xM16	6xM16
J	16	19,5	26	30	34	40	57	72	87	84,5
FİYAT USD										

STANDART AKSESUARLAR	1 TAKIM DÜZ AYAK	1 TAKIM TERS AYAK	1 ADET ANAHTAR	FLANŞ BAĞLAMA CİVATASI	İSTEĞE BAĞLI AKSESUARLAR	1 TAKIM YUMUŞAK AYAK	AYNA BAĞLAMA FLANŞI
							

## KEPENKLİ AYNA

TİP K72

## ÖZELLİKLER

- 4 AYAKLIDIR VE HER BİR AYAK BAĞIMSIZ OLARAK AYARLANABİLİR
- KARE, ÇOKGEN, DAİRESEL OLAN VEYA OLMAYAN PARÇALARIN İŞLENMESİNDE KULLANILIR
- ÜNİVERSAL TORNA TEZGAHLARINDA FENER MİLİNE FLANŞ İLE BAĞLANIR
- FREZELERDE, DİVİZÖRLERDE VE TABLALARDA KULLANILABİLİR
- DÖKÜM GÖVDELİDİR

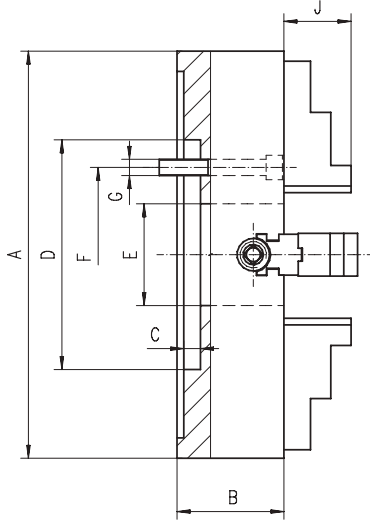

KOD	CHARK.100	CHARK.125	CHARK.160	CHARK.200	CHARK.250	CHARK.320	CHARK.400	CHARK.500	CHARK.630	CHARK.800	CHARK.1000
ØA	100	125	160	200	250	320	400	500	630	800	1000
B	72	95	65	80	90	90	95	106	118	132	150
C	3,5	4,5	5	6	6	6	8	8	10	12	15
D H7	54	56	75	80	110	140	160	200	220	250	320
E	25	30	45	56	75	95	125	160	180	210	260
F	84	108	95	112	130	165	185	236	258	300	370
G	4xM8	4xM8	4xM10	4xM10	4xM12	4xM16	4xM16	4xM20	4xM20	8xM20	8xM120
J	20	22	24	27	30	44	48	55	62	70	80
FİYAT USD											

STANDART AKSESUARLAR	1 TAKIM AYAK	1 ADET ANAHTAR	FLANŞ BAĞLAMA CİVATASI	İSTEĞE BAĞLI AKSESUARLAR	AYNA BAĞLAMA FLANŞI

## 3 AYAKLI DÖNDÜRÜLEBİLİR TORNA AYNASI

TİP K11

## ÖZELLİKLER

- 3 AYAKLI MERKEZİ SIKMALI ÜNİVERSAL TORNA AYNASI
- 2 PARÇALI AYAKLARIN ÜST KISMI DÖNDÜRÜLEBİLİR
- AYAKLAR TERS VE DÜZ OLARAK KULLANILABİLİR, AYRICA AYAR GEREKTİRMEZ
- ÜNİVERSAL TORNA TEZGAHLARINDA FENER MİLİNE FLANŞ İLE BAĞLANIR
- FREZELERDE, DİVİZÖRLERDE VE TABLALARDA KULLANILIR
- DÖKÜM GÖVDELİDİR

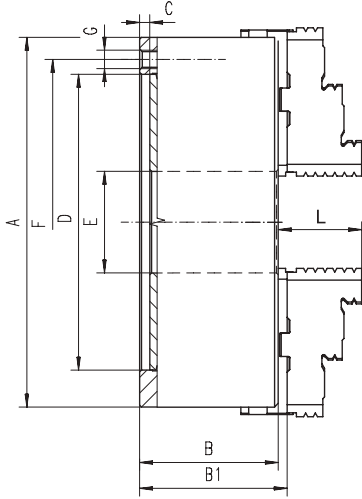

KOD	CHARD.160	CHARD.200	CHARD.250	CHARD.315	CHARD.400	CHARD.500	CHARD.630
ØA	160	200	250	315	400	500	630
B	65	75	80	90	100	115	133,5
B1	71	80	86	95	108	126	142
C	5	5	5	6	6	6	7
D H	130	165	206	260	340	440	560
E	40	65	80	100	130	210	270
F	142	180	226	285	368	465	595
G	3xM8	3xM10	3xM12	3xM16	3xM16	6xM16	6xM16
L	44	47	50	63	72	87	84,5
Kg	8,3	14,1	23	41	71	119	215
FİYAT USD							

STANDART AKSESUARLAR	1 TAKIM ÜST AYAK	1 TAKIM ALT AYAK	1 ADET ANAHTAR	FLANŞ BAĞLAMA CİVATASI	İSTEĞE BAĞLI AKSESUARLAR	AYNA BAĞLAMA FLANŞI

## 4 AYAKLI DÖNDÜRÜLEBİLİR TORNA AYNASI

TİP K12

## ÖZELLİKLER

- 4 AYAKLI MERKEZİ SIKMALI ÜNİVERSAL TORNA AYNASI
- 2 PARÇALI AYAKLARIN ÜST KISMI DÖNDÜRÜLEBİLİR
- AYAKLAR TERS VE DÜZ OLARAK KULLANILABİLİR, AYRICA AYAR GEREKTİRMEZ
- ÜNİVERSAL TORNA TEZGAHLARINDA FENER MİLİ FLANŞ İLE BAĞLANIR
- FREZELERDE, DİVİZÖRLER VE TABLALARDA KULLANILIR
- DÖKÜM GÖVDELİDİR

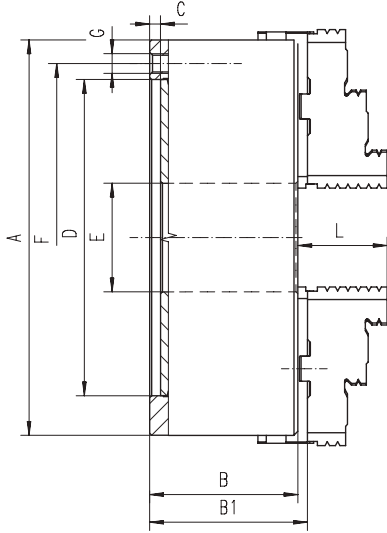

KOD	CHARD.160	CHARD.200	CHARD.250	CHARD.315	CHARD.400	CHARD.500	CHARD.630
ØA	160	200	250	315	400	500	630
B	65	75	80	90	100	115	133,5
B1	71	80	86	95	108	126	142
C	5	5	5	6	6	6	7
D H7	130	165	206	260	340	440	560
E	40	65	80	100	130	210	270
F	142	180	226	285	368	465	595
G	3xM8	3xM10	3xM12	3xM16	3xM16	6xM16	6xM16
L	44	47	50	63	72	87	84,5
FİYAT USD							

STANDART AKSESUARLAR	1 TAKIM ÜST AYAK	1 TAKIM ALT AYAK	1 ADET ANAHTAR	FLANŞ BAĞLAMA CİVATASI	İSTEĞE BAĞLI AKSESUARLAR	AYNA BAĞLAMA FLANŞI

## 3 AYAKLI DÖNDÜRÜLEBİLİR ÖNDEN BAĞLANTILI TORNA AYNASI

TİP K11

## ÖZELLİKLER

- 3 AYAKLI MERKEZİ SIKMALI ÜNİVERSAL TORNA AYNASI
- 2 PARÇALI AYAKLARIN ÜST KISMI DÖNDÜRÜLEBİLİR
- AYAKLAR TERS VE DÜZ OLARAK KULLANILABİLİR, AYRICA AYAR GEREKTİRMEZ
- ÜNİVERSAL TORNA TEZGAHLARINDA FENER MİLİ FLANŞ İLE ÖNDEN BAĞLANIR
- FREZELERDE, DİVİZÖRLER VE TABLALARDA KULLANILIR
- DÖKÜM GÖVDELİDİR
- DİVİZÖR AYNASI OLARAKDA ADLANDIRILIR

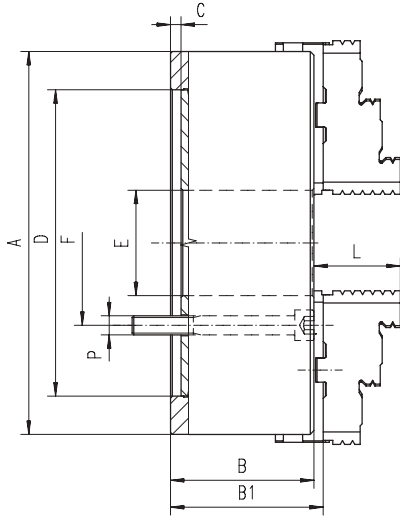

KOD	CHARDFRN.	CHARDFRN.	CHARDFRN.	CHARDFRN.	CHARDFRN.	CHARDFRN.	CHARDFRN.
ØA	160	200	250	315	400	500	630
B	65	75	80	90	100	115	133,5
B1	71	80	86	95	108	126	142
C	5	5	5	6	6	6	7
D H7	130	165	206	260	340	440	560
E	40	65	80	100	130	210	270
F	56	83,5	100	123,5	166,5	245	315
G	3xM8	3xM10	3xM12	3xM16	3xM16	6xM16	6xM16
L	44	47	50	63	72	87	84,5
Kg	8,3	14,1	23	41	71	119	215
FİYAT USD							

STANDART AKSESUARLAR	1 TAKIM ÜST AYAK	1 TAKIM ALT AYAK	1 ADET ANAHTAR	FLANŞ BAĞLAMA CİVATASI	İSTEĞE BAĞLI AKSESUARLAR	AYNA BAĞLAMA FLANŞI

## 4 AYAKLI DÖNDÜRÜLEBİLİR ÖNDEN BAĞLANTILI TORNA AYNASI

TİP K12

## ÖZELLİKLER

- 4 AYAKLI MERKEZİ SIKMALI ÜNİVERSAL TORNA AYNASI
- K2 PARÇALI AYAKLARIN ÜST KISMI DÖNDÜRÜLEBİLİR
- AYAKLAR TERS VE DÜZ OLARAK KULLANILABİLİR, AYRICA AYAR GEREKTİRMEZ
- ÜNİVERSAL TORNA TEZGAHLARINDA FENER MİLİNE FLANŞ İLE ÖNDEN BAĞLANIR
- FREZELERDE, DİVİZÖRLERDE VE TABLALARDA KULLANILIR
- DÖKÜM GÖVDELİDİR
- DİVİZÖR AYNASI OLARAKDA ADLANDIRILIR

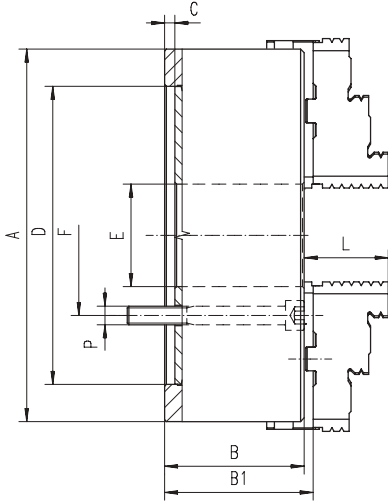

KOD	CHARDFRN.	CHARDFRN.	CHARDFRN.	CHARDFRN.	CHARDFRN.	CHARDFRN.	CHARDFRN.
ØA	160	200	250	315	400	500	630
B	65	75	80	90	100	115	133,5
B1	71	80	86	95	108	126	142
C	5	5	5	6	6	6	7
D H7	130	165	206	260	340	440	560
E	40	65	80	100	130	210	270
F	56	83,5	100	123,5	166,5	245	315
G	3xM8	3xM10	3xM12	3xM16	3xM16	6xM16	6xM16
L	44	47	50	63	72	87	84,5
FİYAT USD							

STANDART AKSESUARLAR	1 TAKIM ÜST AYAK	1 TAKIM ALT AYAK	1 ADET ANAHTAR	FLANŞ BAĞLAMA CİVATASI	İSTEĞE BAĞLI AKSESUARLAR	AYNA BAĞLAMA FLANŞI



## ÜNİVERSAL TORNA AYNASI DÜZ AYAK TAKIMI

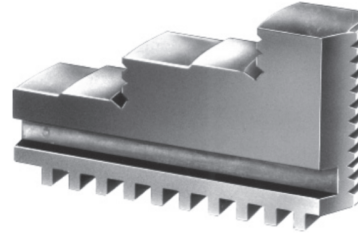
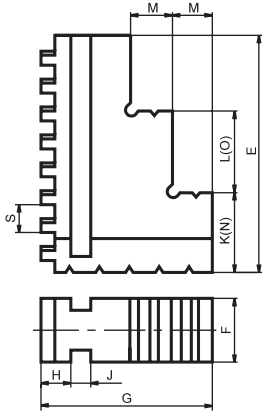

KOD	Ø	E	F	G	H	J	K	L	M	S	3 AYAKLI SET	4 AYAKLI SET
											FİYAT USD	FİYAT USD
CHAR.AYAKD	80	33	12	33	6	7	12,5	10	6,6	5		
CHAR.AYAKD	100	39	15	39	6,4	8	14,4	16,5	7,2	5,8		
CHAR.AYAKD	125	52,5	16	45	7	8	17,5	19	7,8	5,8		
CHAR.AYAKD	160	70	18,5	53	8,6	10	22,5	26	11	7,8		
CHAR.AYAKD	200	85,5	22	65	10	10	29,5	27,5	13,6	7,8		
CHAR.AYAKD	250	105	27	73	12,5	10	35	35	14	10		
CHAR.AYAKD	315	127	36,5	86	14	12,7	42	42	17	10,8		
CHAR.AYAKD	400	127	36,5	86	14	13	42	42	17	11,8		
CHAR.AYAKD	500	184	45	102	15	16	52	70	24	13		

## ÜNİVERSAL TORNA AYNASI TERS AYAK TAKIMI

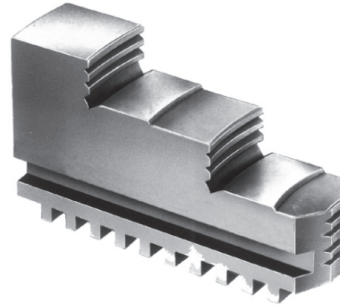
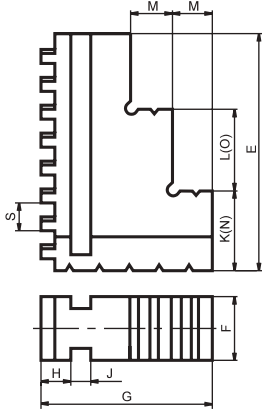

KOD	Ø	E	F	G	H	J	K	L	M	S	3 AYAKLI SET	4 AYAKLI SET
											FİYAT USD	FİYAT USD
CHAR.AYAKT	80	33	12	33	6	7	12,5	10	6,6	5		
CHAR.AYAKT	100	39	15	39	6,4	8	14,4	16,5	7,2	5,8		
CHAR.AYAKT	125	52,5	16	45	7	8	17,5	19	7,8	5,8		
CHAR.AYAKT	160	70	18,5	53	8,6	10	22,5	26	11	7,8		
CHAR.AYAKT	200	85,5	22	65	10	10	29,5	27,5	13,6	7,8		
CHAR.AYAKT	250	105	27	73	12,5	10	35	35	14	10		
CHAR.AYAKT	315	127	36,5	86	14	12,7	42	42	17	10,8		
CHAR.AYAKT	400	127	36,5	86	14	13	42	42	17	11,8		
CHAR.AYAKT	500	184	45	102	15	16	52	70	24	13		

## ÜNİVERSAL TORNA AYNASI İÇİN DÖNDÜRÜLEBİLİR AYAK TAKIMI

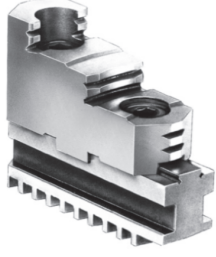

## ÜNİVERSAL TORNA AYNASI İÇİN YUMUŞAK AYAK TAKIMI

4 ADET

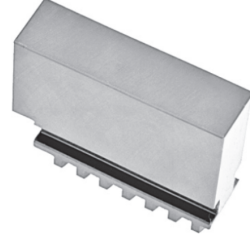

KOD	EBAT	3'LÜ SET	4'LÜ SET
		FİYAT USD	FİYAT USD
CHAR.AYAKDN	160		
CHAR.AYAKDN	200		
CHAR.AYAKDN	250		
CHAR.AYAKDN	315		
CHAR.AYAKDN	400		
CHAR.AYAKDN	500		
CHAR.AYAKDN	630		

KOD	EBAT	3'LÜ SET	4'LÜ SET
		FİYAT USD	FİYAT USD
CHAR.AYAKY	80		
CHAR.AYAKY	100		
CHAR.AYAKY	125		
CHAR.AYAKY	160		
CHAR.AYAKY	200		
CHAR.AYAKY	250		
CHAR.AYAKY	315		
CHAR.AYAKY	400		
CHAR.AYAKY	500		
CHAR.AYAKY	630		
CHAR.AYAKY	800		

## ÜNİVERSAL TORNA AYNASI İÇİN SİRİAL



KOD	EBAT	FİYAT USD
CHAR.SPR	80	
CHAR.SPR	100	
CHAR.SPR	125	
CHAR.SPR	160	
CHAR.SPR	200	
CHAR.SPR	250	
CHAR.SPR	315	
CHAR.SPR	400	
CHAR.SPR	500	
CHAR.SPR	630	
CHAR.SPR	800	

## ÜNİVERSAL TORNA AYNASI İÇİN ANAHTAR

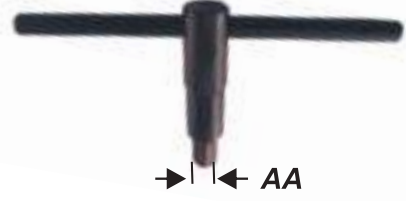

KOD	EBAT	AA	FİYAT USD
CHAR.ANH	80	8	
CHAR.ANH	100	8	
CHAR.ANH	125	10	
CHAR.ANH	160	10	
CHAR.ANH	200	12	
CHAR.ANH	250	12	
CHAR.ANH	315	13	
CHAR.ANH	400	14	
CHAR.ANH	500	17	
CHAR.ANH	630	-	
CHAR.ANH	800	-	

## ÜNİVERSAL TORNA AYNASI İÇİN PİNYON / ADET



KOD	EBAT	FİYAT USD
CHAR.PNY	80	
CHAR.PNY	100	
CHAR.PNY	125	
CHAR.PNY	160	
CHAR.PNY	200	
CHAR.PNY	250	
CHAR.PNY	315	
CHAR.PNY	400	
CHAR.PNY	500	
CHAR.PNY	630	
CHAR.PNY	800	

## ÜNİVERSAL TORNA AYNASI İÇİN PİNYON PİMİ / ADET



KOD	EBAT	FİYAT USD
CHAR.PİM	80	
CHAR.PİM	100	
CHAR.PİM	125	
CHAR.PİM	160	
CHAR.PİM	200	
CHAR.PİM	250	
CHAR.PİM	315	
CHAR.PİM	400	
CHAR.PİM	500	
CHAR.PİM	630	
CHAR.PİM	800	

## ANAHTARLI MANDREN



KOD	ÖLÇÜ (mm)	FİYAT USD
C8613	6 mm 3/8"-24 UNF	
C8510	6 mm B10	
C8621	1-10 mm 1/2"-20 UNF	
C8623	1-10 mm 3/8"-24 UNF	
C8522	1-10 mm B12	
C8631	1-13 mm 1/2"-20 UNF	
C8633	1-13 mm 3/8"-24 UNF	
C8536	1-13 mm B16	
C8641	3-16 mm 1/2"-20 UNF	
C8546	3-16 mm B16	
C8548	3-16 mm B18	
C8552	5-20 mm B22	

## MANDREN ANAHTARI



KOD	ÖLÇÜ (mm)	FİYAT USD
C8902	S1 MANDREN ANAHTARI (10-13 mm İÇİN)	
C8903	S2 MANDREN ANAHTARI (16 mm İÇİN)	
C8904	S3 MANDREN ANAHTARI (20 mm İÇİN)	
C8905	MANDREN ANAHTARI (10 mm 3/8" İÇİN)	

## ELLE SIKMALI MANDREN (PLASTİK GÖVDELİ)



KOD	ÖLÇÜ (mm)	FİYAT USD
C8613P	6 mm 3/8"-24 UNF	
C8623P	10 mm 3/8"-24 UNF	
C8131P	13 mm 1/2"-20 UNF	

## KİLİTLİ ELLE SIKMALI MANDREN (METAL GÖVDELİ)



KOD	ÖLÇÜ (mm)	FİYAT USD
C8131M	13 mm 1/2"-20 UNF	