

## BISON TORNA AYNALARININ İŞ BAĞLAMA HASSASİYETİNİN DIN STANDARTLARI İLE KARŞILAŞTIRMA TABLOSU

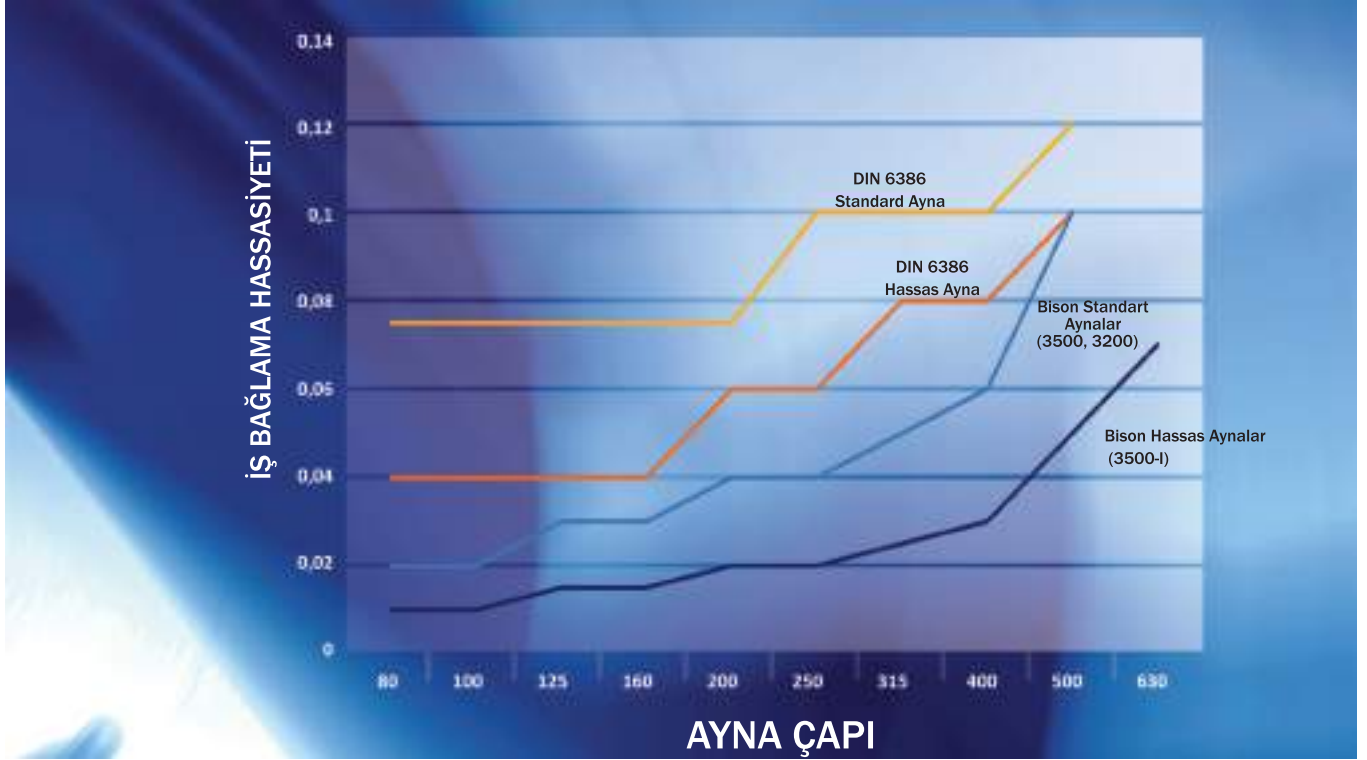

### GÖVDE

- Tip 3200 ve 3600 serisi: Yüksek kaliteli dökümden imal edilmiştir.
- Tüm aynaların gövdelerinin üzerinde yağlamak için gresörlük bulunmaktadır.

### AYAKLAR

- Alaşımli çelikten imal edilmiştir.
- Dişler ve diğer çalışan yüzeyler karbonlanmış, sertleştirilmiş ve taşlanmıştır.

### PİNYONLAR

- Alaşımli çelikten imal edilmiş olup karbonlanmış, sertleştirilmiş ve taşlanmıştır.

### SİRAL

- Alaşımli çelikten imal edilmiş olup karbonlanmış ve sertleştirilmiştir.
- Dişlerin her iki yanında taşlanmıştır.

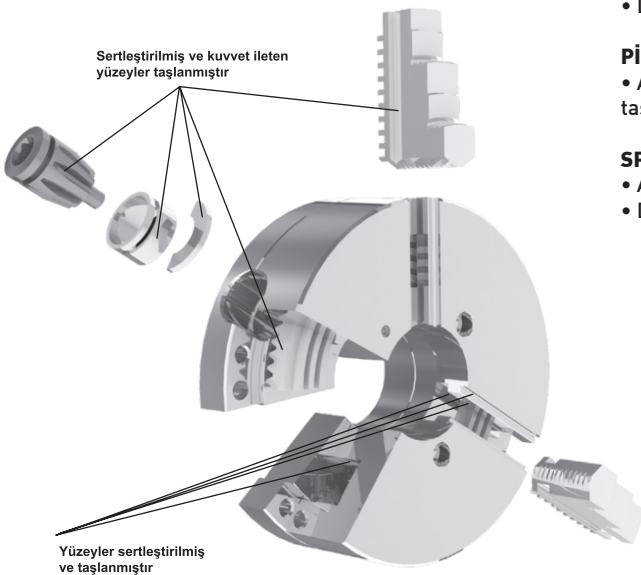

## 3 AYAKLI VE 4 AYAKLI ÜNİVERSAL AYNALAR İÇİN TEKNİK BİLGİLER

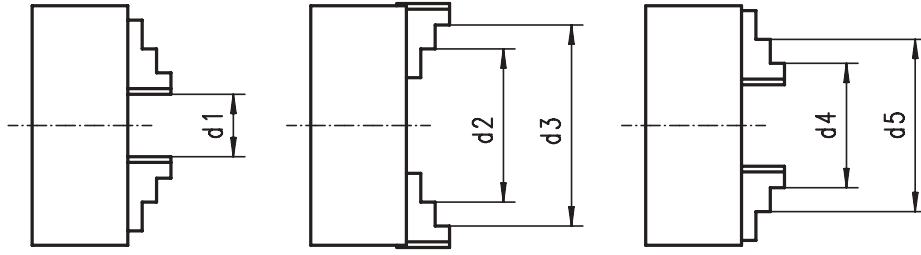

## 3 AYAKLI VE 4 AYAKLI ÜNİVERSAL AYNALARIN İŞ BAĞLAMA KAPASİTELERİ VE MAKSİMUM DEVİRLERİ

AYNA ÇAPI		80	100	125	160	200
SERT AYAK	d1	2-27	3-33	3-50	3-64	4-90
	d2	25-50	32-62	39-83	50-107	60-145
	d3	48-71	62-93	80-125	98-160	130-200
	d4	22-46	25-56	34-74	42-100	52-135
	d5	45-69	56-87	72-115	94-154	120-202
DÖNDÜRÜLEBİLİR AYAK ( 2 PARÇA )	d1	-	-	3-50	3-64	4-90
	d2	-	-	52-96	62-121	72-156
	d3	-	-	95-125	115-160	133-200
	d4	-	-	34-76	42-97	50-130
	d5	-	-	75-118	88-146	105-190
MAKSİMUM ÇEVİRME ÇAPI		90	117	151	204	246
3200 Max. d/d		5000	4500	4000	3600	3000

AYNA ÇAPI		250	315	400	500	630	800	915	1000
SERT AYAK TEK PARÇA	d1	5-118	10-131	10-180	20-235	30-335	150-482	-	-
	d2	77-188	90-215	103-272	140-357	180-487	302-634	-	-
	d3	160-250	190-315	230-400	276-500	345-630	468-800	-	-
	d4	62-174	78-200	85-252	120-335	160-465	282-614	-	-
	d5	145-256	172-299	210-380	245-476	325-630	448-780	-	-
DÖNDÜRÜLEBİLİR AYAK ( 2 PARÇA )	d1	5-118	10-131	10-180	20-235	30-335	150-482	200 - 550	250 - 600
	d2	86-197	103-226	127-294	110-400	120-570	240-724	300 - 950	350 - 1080
	d3	160-250	190-315	230-400	190-500	200-630	316-800	380 - 1025	430 - 1150
	d4	58-165	65-182	72-228	120-410	140-590	252-736	350 - 1000	425 - 1070
	d5	125-235	145-265	165-329	200-485	210-665	328-812	450 - 1025	500 - 1150
MAKSİMUM ÇEVİRME ÇAPI		306	384	472	600	770	940	-	-
3200 Max. d/d		2500	2000	1600	1000	800	600	400	400

## KEPENKLİ AYNALAR İÇİN TEKNİK BİLGİLER

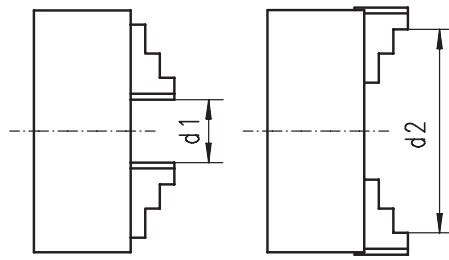

## KEPENKLİ AYNALAR İÇİN İŞ BAĞLAMA KAPASİTELERİ

AYNA ÇAPI	85	100	125	160	200	250	315	350
d1 min.	3	3	8	8	10	10	15	15
d2 max.	85	100	125	160	200	250	315	350
MAKSİMUM ÇEVİRME ÇAPI	101	116	150	185	235	296	369	404
AYNA ÇAPI	400	500	630	800	915	1000	1250	
d1 min.	20	45	50	50	120	170	170	
d2 max.	400	500	630	800	915	1000	1250	
MAKSİMUM ÇEVİRME ÇAPI	465	570	720	888	1003	1088	1338	
AYNA ÇAPI	85	100	125	160	200	250	315	350
ÇELİK GÖVDE d/dk	4000	3800	3500	3200	2500	2000	1500	1500
DÖKME DEMİR GÖVDE d/dk	-	-	-	-	1800	1500	1200	1200
AYNA ÇAPI	400	500	630	800	915	1000	1250	
ÇELİK GÖVDE d/dk	1100	700	550	450	200	200	150	
DÖKME DEMİR GÖVDE d/dk	800	500	400	300	150	150	100	

### ÜNİVERSAL TORNA AYNASI İÇİN AYAK ÖLÇÜLERİ

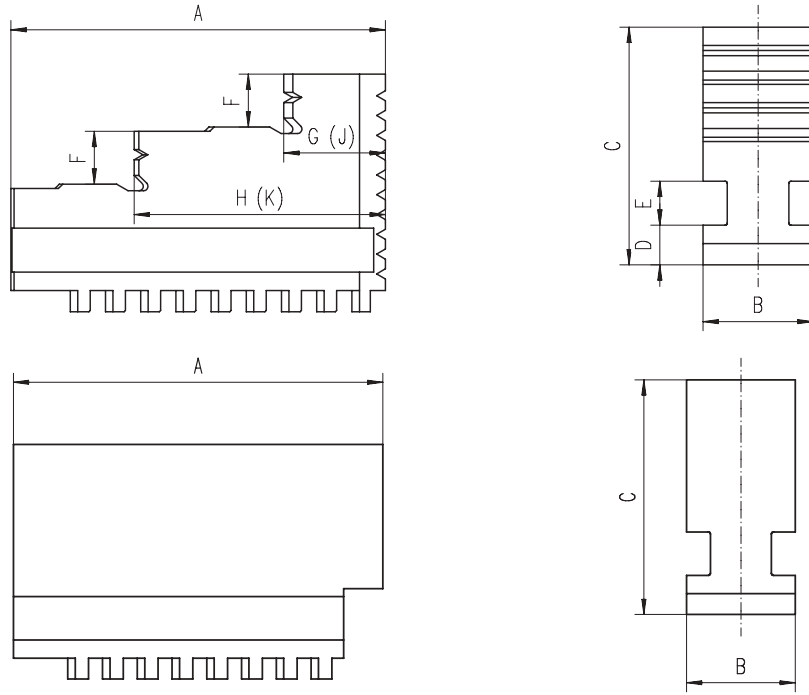

AYNA ÇAPI		80	100	125	160	200
	<b>A</b>	32	42	51	70	85
	<b>B</b>	11	15	20	20	25
	<b>C</b>	28	32	40	53	54
	<b>D</b>	6	6	8	8	9
	<b>E</b>	6	6	8	8	10
	<b>F</b>	6	7	8	10	12
	<b>G</b>	9,5	11	13	19	23
	<b>H</b>	21	27	33,5	45	57
	<b>J</b>	9,5	12	13	22	23
	<b>K</b>	21	27,5	33,5	47,5	57
Kg	<b>SERT AYAK</b>	0,03	0,09	0,18	0,36	0,50
	<b>YUMUŞAK AYAK</b>	0,07	0,13	0,26	0,50	0,80

AYNA ÇAPI		250	315	400	500	630	800
	<b>A</b>	105	125	145	180	225	225
	<b>B</b>	28	32	36	40	50	50
	<b>C</b>	63	73	92	100	110	110
	<b>D</b>	11	12,7	15	16	16	16
	<b>E</b>	12	12	14	14	14	14
	<b>F</b>	14	18	22	26	28	28
	<b>G</b>	28	34,5	36	50	66	66
	<b>H</b>	69,5	83	99	119,5	149	149
	<b>J</b>	28	34,5	36	50	66	66
	<b>K</b>	69,5	83	99	119,5	149	149
Kg	<b>SERT AYAK</b>	0,80	1,32	2,35	3,36	5,80	5,80
	<b>YUMUŞAK AYAK</b>	1,36	1,90	2,46	5,00	8,36	8,36

## 3 AYAKLI DÖKÜM GÖVDELİ ( DIN 6350 )

TİP 3204

## ÖZELLİKLER

- 3 AYAKLI MERKEZİ SIKMALI UNİVERSAL TORNA AYNASI
- YÜKSEK KALİTELİ DÖKÜM GÖVDE
- UNİVERSAL TORNA TEZGAHLARINDA FENER MİLİNE FLANŞ İLE BAĞLANIR
- FREZELERDE, DİVİZÖRLERDE VE TABLALARDA KULLANILIR

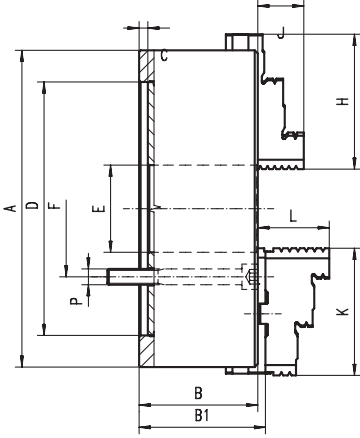

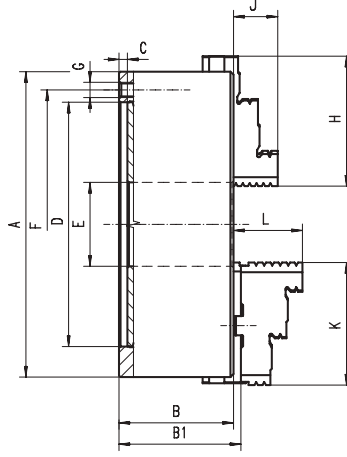

Ø80-630 mm AYNALAR

Ø800-915-1000 mm AYNALAR  
\*ÖNDEN CİVATA BAĞLANTILIDIR.

\* ÖNDEN CİVATA BAĞLANTILI

KOD	BIS.AYN.	BIS.AYN.	BIS.AYN.	BIS.AYN.	BIS.AYN.	BIS.AYN.	BIS.AYN.	BIS.AYN.	BIS.AYN.	BIS.AYN.	BIS.AYN.	BIS.AYN.	BIS.AYN.	BIS.AYN.
Ø	80	100	125	160	200	250	315	400	500	630	800	915	1000	
B	44	50	56	64,5	75	85	94	105	120	135	159	171	171	
B1	-	-	60,8	69,3	79,8	88,8	99,1	113,8	130,8	146,3	170,3	180	180	
C	3	3	4	4	4	5	5	5	5	7	20	20	20	
D H7	56	70	95	125	160	200	260	330	420	545	450	520	520	
E	16	20	32	42	55	76	103	136	190	252	320	408	408	
F	67	83	108	140	176	224	286	362	458	586	368,3	463,6	463,6	
G	3xM6	3xM8	3xM8	6xM10	6xM10	6xM12	6xM16	6xM16	6xM16	6xM16	-	-	-	
H	32	42	51	70	85	105	125	145	180	225	225	-	-	
J	13	-	56	67	29	95	43	55	60	70	70	-	-	
K	-	17	20	32	80	34	110	127	127	127	127	175	175	
L	-	-	40	43	45	53	57	67	70	87	87	100	100	
KG	1,5	2,8	5	10	17,5	29	50	85	145	250	402	560	720	
FİYAT EUR														

STANDART AKSESUARLAR	1 TAKIM DÜZ AYAK	1 TAKIM TERS AYAK	1 ADET ANAHTAR	FLANŞ BAĞLAMA CIVATASI	İSTEĞE BAĞLI AKSESUARLAR	1 TAKIM YUMUŞAK AYAK	AYNA BAĞLAMA FLANŞI
							

NOT: DÖNDÜRÜLEBİLİR AYAK TAKILARAK KULLANILABİLİR. UYGUN AYAK İÇİN 443. SAYFAYA BAKINIZ.

## 4 AYAKLI DÖKÜM GÖVDELİ ( DIN 6350 )

TİP 3604

## ÖZELLİKLER

- 4 AYAKLI MERKEZİ SIKMALI UNİVERSAL TORNA AYNASI
- YÜKSEK KALİTELİ DÖKÜM GÖVDE
- UNİVERSAL TORNA TEZGAHLARINDA FENER MİLİNE FLANŞ İLE BAĞLANIR
- FREZELERDE, DİVİZÖRLERDE VE TABLALARDA KULLANILIR

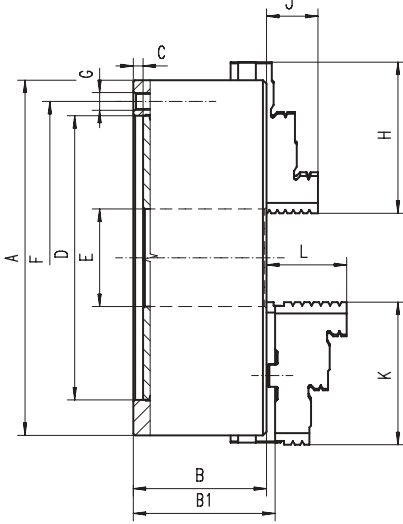

KOD	BIS.AYN.	BIS.AYN.	BIS.AYN.	BIS.AYN.	BIS.AYN.	BIS.AYN.	BIS.AYN.	BIS.AYN.
Ø	125	160	200	250	315	400	500	630
B1	60,8	69,3	79,8	88,8	99,1	113,8	130,8	146,3
C	4	4	4	5	5	5	5	7
D H7	95	125	160	200	260	330	420	545
E	32	42	55	76	103	136	190	252
F	108	140	176	224	286	362	458	586
G	3xM8	6xM10	6xM10	6xM12	6xM16	6xM16	6xM16	6xM16
H	51	70	85	105	125	145	180	225
J	56	67	80	95	110	127	60	70
K	20	32	29	34	43	55	127	127
L	40	43	45	53	57	67	70	87
KG	5	10	17,5	29	50	85	145	250
FİYAT EUR								

STANDART AKSESUARLAR	1 TAKIM DÜZ AYAK	1 TAKIM TERS AYAK	1 ADET ANAHTAR	FLANŞ BAĞLAMA CİVATASI	İSTEĞE BAĞLI AKSESUARLAR	1 TAKIM YUMUŞAK AYAK	AYNA BAĞLAMA FLANŞI
							

**NOT: DÖNDÜRÜLEBİLİR AYAK TAKILARAK KULLANILABİLİR. UYGUN AYAK İÇİN 444. SAYFAYA BAKINIZ.**

## KEPENKLİ AYNA



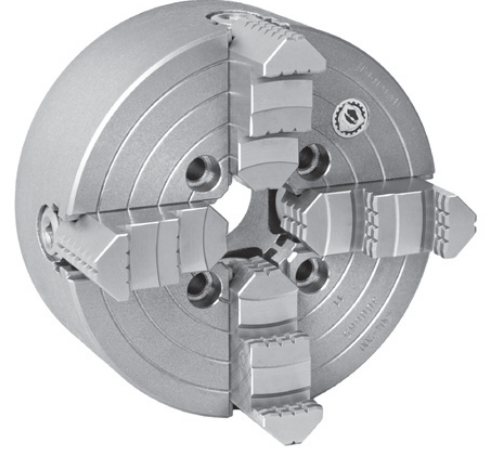
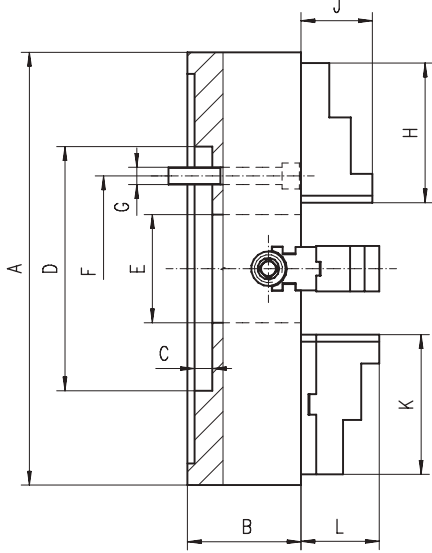

TİP 4304

## ÖZELLİKLER

- 4 AYAKLIDIR VE HER BİR AYAK BAĞIMSIZ OLARAK AYARLANABİLİR
- KARE, ÇOKGEN, DAİRESEL OLAN VEYA OLMAYAN PARÇALARIN İŞLENMESİNDE KULLANILIR
- ÜNİVERSAL TORNA TEZGAHLARINDA FENER MİLİNE FLANŞ İLE BAĞLANIR
- FREZELERDE, DİVİZÖRLERDE VE TABLALARDA KULLANILABİLİR



KOD	BIS.KEP.	BIS.KEP.	BIS.KEP.	BIS.KEP.	BIS.KEP.	BIS.KEP.	BIS.KEP.	BIS.KEP.	BIS.KEP.	BIS.KEP.	BIS.KEP.
Ø	200	250	315	350	400	500	630	800	915	1000	1250
A	200	250	315	350	400	500	630	800	915	1000	1250
B	80	85	95	95	105	120	140	160	170	170	190
C	5	7	7	7	10	12	12	12	18	18	18
D H7	110	150	175	175	200	270	270	380	370	370	550
E	50	65	80	80	100	125	160	200	190	190	190
F	82,6	104,8	133,4	133,4	171,4	235	235	330	330	330	500
G	4xM10	4xM12	4xM16	4xM16	4xM16	4xM20	4xM20	4xM24	8xM24	8xM24	8xM24
H	81	96,5	111	111	129	152,5	177	202	-	-	-
J	40,3	40,3	49,8	49,8	49,8	59,8	59,8	70,8	-	-	-
K	82	96,5	112,5	-	129	136	136	136	160	160	160
L	46,4	25	39	47,5	61	90,3	163	93,8	102,8	410	102,8
KG	14	60,4	60,9	-	72,3	105	97,8	319	350	410	950
FİYAT EUR											

STANDART AKSESUARLAR	1 TAKIM AYAK	1 ADET ANAHTAR	FLANŞ BAĞLAMA CİVATASI	İSTEĞE BAĞLI AKSESUARLAR	AYNA BAĞLAMA FLANŞI
					

## ÜNİVERSAL TORNA AYNASI İÇİN TERS AYAK TAKIMI

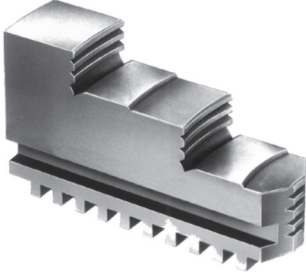

KOD	EBAT	3 AYAKLI SET	4 AYAKLI SET
		FİYAT EUR	FİYAT EUR
BIS.AYAKT	80		
BIS.AYAKT	100		
BIS.AYAKT	125		
BIS.AYAKT	160		
BIS.AYAKT	200		
BIS.AYAKT	250		
BIS.AYAKT	315		
BIS.AYAKT	400		
BIS.AYAKT	500		
BIS.AYAKT	630		
BIS.AYAKT	800		

## ÜNİVERSAL TORNA AYNASI İÇİN DÜZ AYAK TAKIMI

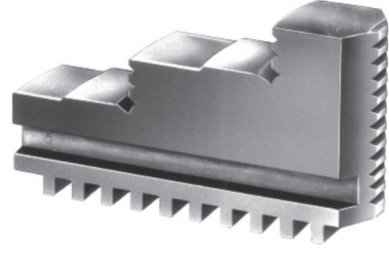

KOD	EBAT	3 AYAKLI SET	4 AYAKLI SET
		FİYAT EUR	FİYAT EUR
BIS.AYAKD	80		
BIS.AYAKD	100		
BIS.AYAKD	125		
BIS.AYAKD	160		
BIS.AYAKD	200		
BIS.AYAKD	250		
BIS.AYAKD	315		
BIS.AYAKD	400		
BIS.AYAKD	500		
BIS.AYAKD	630		
BIS.AYAKD	800		

## ÜNİVERSAL TORNA AYNASI İÇİN DÖNDÜRÜLEBİLİR AYAK TAKIMI

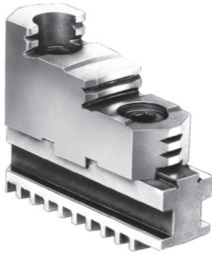

KOD	EBAT	3 AYAKLI SET	4 AYAKLI SET
		FİYAT EUR	FİYAT EUR
BIS.AYAK.DN	160		
BIS.AYAK.DN	200		
BIS.AYAK.DN	250		
BIS.AYAK.DN	315		
BIS.AYAK.DN	400		

## ÜNİVERSAL TORNA AYNASI İÇİN YUMUŞAK AYAK TAKIMI

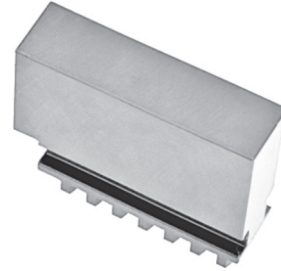

KOD	EBAT	3 AYAKLI SET	4 AYAKLI SET
		FİYAT EUR	FİYAT EUR
BIS.AYAKY	80		
BIS.AYAKY	100		
BIS.AYAKY	125		
BIS.AYAKY	160		
BIS.AYAKY	200		
BIS.AYAKY	250		
BIS.AYAKY	315		
BIS.AYAKY	400		
BIS.AYAKY	500		
BIS.AYAKY	630		
BIS.AYAKY	800		

ÜNİVERSAL TORNA AYNASI İÇİN SPİRAL



KOD	EBAT	FİYAT EUR
BIS.SPR.	80	
BIS.SPR.	100	
BIS.SPR.	125	
BIS.SPR.	160	
BIS.SPR.	200	
BIS.SPR.	250	
BIS.SPR.	315	
BIS.SPR.	400	
BIS.SPR.	500	
BIS.SPR.	630	
BIS.SPR.	800	

ÜNİVERSAL TORNA AYNASI İÇİN ANAHTAR

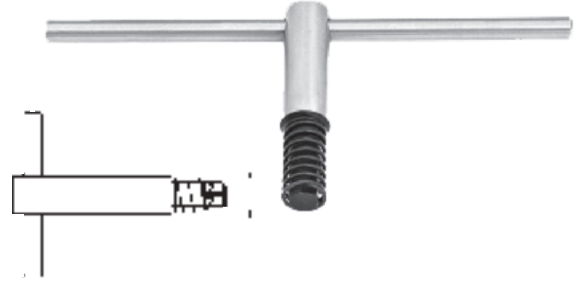

KOD	EBAT	S	FİYAT EUR
BIS.ANH.	80	6	
BIS.ANH.	100	9	
BIS.ANH.	125	8	
BIS.ANH.	160	11	
BIS.ANH.	200	11	
BIS.ANH.	250	14	
BIS.ANH.	315	14	
BIS.ANH.	400	17	
BIS.ANH.	500	17	
BIS.ANH.	630	-	
BIS.ANH.	800	-	

ÜNİVERSAL TORNA AYNASI İÇİN PİNYON / ADET



KOD	EBAT	FİYAT EUR
BIS.PNY.	80	
BIS.PNY.	100	
BIS.PNY.	125	
BIS.PNY.	160	
BIS.PNY.	200	
BIS.PNY.	250	
BIS.PNY.	315	
BIS.PNY.	400	
BIS.PNY.	500	
BIS.PNY.	630	
BIS.PNY.	800	

ÜNİVERSAL TORNA AYNASI İÇİN PİNYON PİMİ / ADET



KOD	EBAT	FİYAT EUR
BIS.PİM	80	
BIS.PİM	100	
BIS.PİM	125	
BIS.PİM	160	
BIS.PİM	200	
BIS.PİM	250	
BIS.PİM	315	
BIS.PİM	400	
BIS.PİM	500	
BIS.PİM	630	
BIS.PİM	800	