



*konusulan kalite...  
the spoken quality...  
qualität über die man spricht...*

**2022** KATALOĞU  
CATALOGUE  
KATALOG

*Kesici Uç ve Bağlama Sistemleri  
Cutting Inserts and Connection Systems  
Trägerwerkzeuge für Wendschneidplatten*



[www.akkocom.tr](http://www.akkocom.tr)

*konusulan  
the spoken kalite...  
quality...*



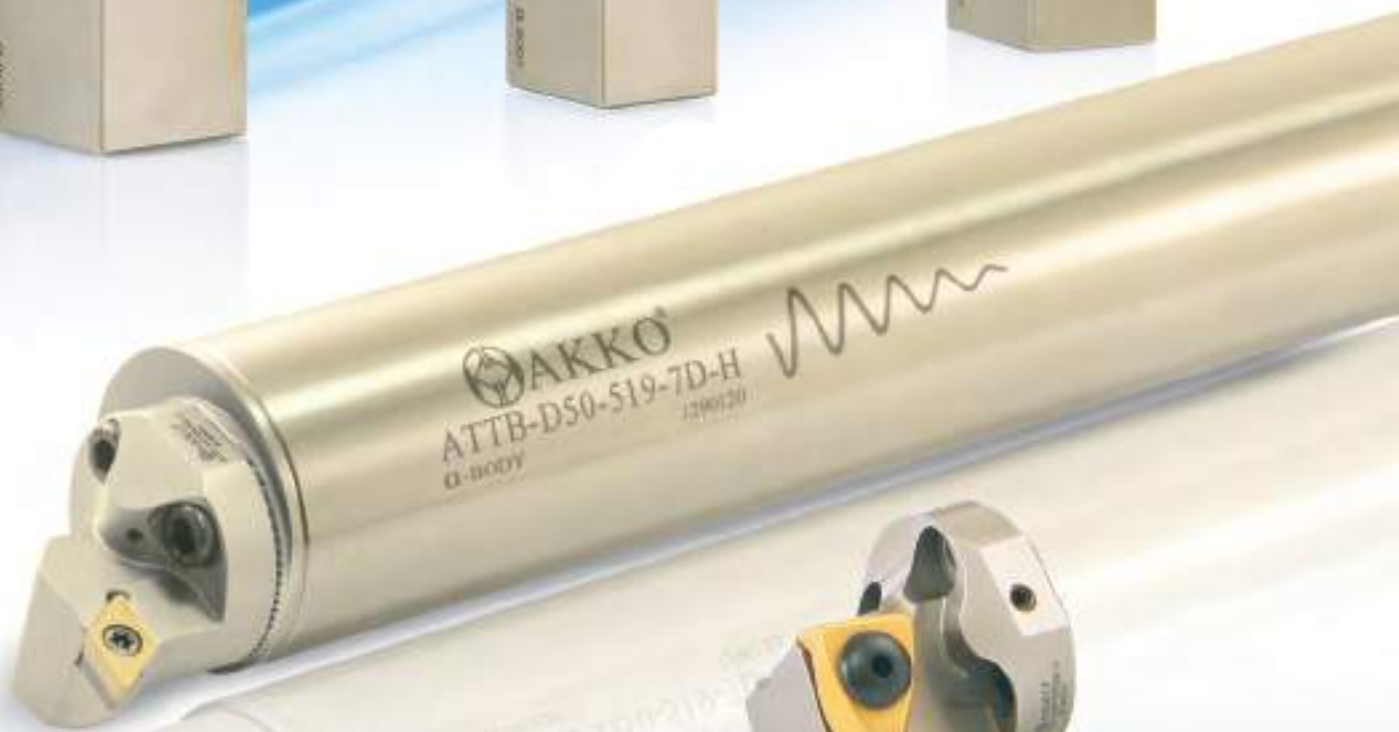



TS EN ISO 9001:2015





1986 yılında Abdullah KARAKUŞ tarafından kurulan AKKO Oto. Mak. Hırd. San. Tic. Ltd. Şti. Tornalama Takımları, Diş ve Kanal Açma Takımları, Delik Delme Takımları, Frezeleme Takımları ve talebe yönelik Özel Takımları üretmektedir. Şu an 39.000 m<sup>2</sup> ye yakın bir alanda Türkiye, Japonya, Almanya, İsviçre gibi ülkelerin ürettikleri son teknoloji tezgah ve ekipmanlarıyla yıllık 400.000 adet üretim kapasitesiyle, standart 10.000 çeşit takım üretimi yapmaktadır. Avrupa, Asya, Afrika, Güney Amerika, Kuzey Amerika ve Orta Doğu kıtalarında şimdilik 90 ülkeye ürün sevkiyatına devam etmektedir. Minimum 300.000 adet üretilmiş ürün stoklarında mevcut bulunmaktadır. Firma için özel üretilen çelik hammadde işleme girer ve bütün üretim süreci kendi bünyesinde gerçekleşmektedir. Çeliğin işlenmesi, ısıl işlemi, üzerindeki kaplama ve her türlü üretim operasyonları bir entegre tesis olan AKKO'da yapılmaktadır.

We as AKKO Oto. Mak. Hırd. San. Tic. Ltd. Şti, which has been founded by Abdullah KARAKUŞ in 1986, produces Turning Tool Holders, Threading and Grooving Tool Holders, U-Drills, Milling Tool Holders, and Precision Tool Holders ( OEM Tool Holders ) on-demand. We produce standard 10.000 kinds of tool holders with a production capacity of 400.000 pieces per annum in an area of about 39.000 square meters. We are going on exporting to 90 countries including European, Asian, African, South American Countries, North American Countries, and Middle East Countries. We keep ready about 300.000 pieces produced products in our stock. Steel Raw materials that we make produced especially for us are delivered our factory and all production process are made in our factory. All kinds of operations from machining of steel to heat treatment and coating on our tools are made in our integrated factory AKKO.

Wir die Firma AKKO Oto. Mak. Hırd. San. Tic. Ltd. Şti, welches durch Herrn Abdullah Karakuş in 1986 gegründet wurde, produzieren Dreh-, Gewinde- und Stechwerkzeuge für Wendeschneidplatten. Ebenso gehören Wendeplattenbohrer, Wendeplattenfräser und Sonderwerkzeuge nach Anfrage für Wendeplatten zum Lieferprogramm. Alle Werkzeuge sind auch als OEM-Version lieferbar. Wir produzieren 10.000 standart Arten der Werkzeughalter mit einer Produktionskapazität von 400.000 Stücken per anum auf einer Fläche von 39.000 quadrat meter. Wir exportieren unsere eigenproduzierten Ware nach 90 Ländern, Europa, Asien, Afrika, Süd amerikanische Länder, Mittlerer Osten. Lieferbereit halten wir 300.000 Stück produzierte Produkte auf Lager. Das eingesetzte Rohmaterial wird speziell für unsere Firma produziert. Alle Produktionsschritte werden auf unseren eigenen Anlagen veranlasst. Alle einzellenen Produktionsschritte wie z.B. mechanische Bearbeitung, Wärmebehandlung und Beschichtung unserer Werkzeuge erfolgen auf unseren eigenen Maschinenanlagen.



|   |  |
|---|--|
| <b>DIŞ TORNA TAKIMLARI</b>  |  |
| S11<br>S12-S28<br>S29-S31<br>S32-S43<br>S44-S50<br>S51-S65<br>S66-S70<br>S70-S73  | DIŞ TORNA KATERLERİ KODLAMA SİSTEMİ<br>T-SİSTEM DIŞ TORNA KATERLERİ<br>M-SİSTEM DIŞ TORNA KATERLERİ<br>P-SİSTEM DIŞ TORNA KATERLERİ<br>C-SİSTEM DIŞ TORNA KATERLERİ<br>S-SİSTEM DIŞ TORNA KATERLERİ<br>S-SİSTEM İSVİÇRE TİPİ KAYAR OTOMAT MAKİNA TAKIMLARI<br>KOLAY DEĞİŞTİRİLEBİLİR İSVİÇRE TİPİ KAYAR OTOMAT MAKİNA TAKIMLARI  |
| <b>DELİK TORNA TAKIMLARI</b>  |  |
| S75<br>S76-S82<br>S83-S87<br>S88-S94<br>S95-S112  | DELİK TORNA KATERLERİ KODLAMA SİSTEMİ<br>T&C SİSTEM DELİK TORNA KATERLERİ<br>M-SİSTEM DELİK TORNA KATERLERİ<br>P-SİSTEM DELİK TORNA KATERLERİ<br>S-SİSTEM DELİK TORNA KATERLERİ  |
| <b>TIRLAMAZ TAKIMLAR-ANTI VIBRATION TOOLS</b>   |  |
| S114<br>S115-S120   | TIRLAMAZ TAKIMLARIN KODLAMA SİSTEMİ<br>TIRLAMAZ TAKIMLAR   |
| <b>KARTUŞLAR</b>  |  |
| S122<br>S123-S125<br>S125-S128<br>S128-S131   | KARTUŞLARIN KODLAMA SİSTEMİ<br>S-TİP RÊKTEFYE KARTUŞLARI<br>S-SİSTEM KARTUŞLAR<br>P-SİSTEM KARTUŞLAR VE BORU PAHLAMA TAKIMLARI   |
| <b>DIŞ AÇMA TAKIMLARI</b>   |  |
| S133<br>S134-S139   | DIŞ AÇMA KATERLERİ KODLAMA SİSTEMİ<br>DIŞ AÇMA KATERLERİ ve TEKNİK BİLGİ   |
| <b>KANAL AÇMA TAKIMLARI</b>   |  |
| S141<br>S142-S157<br>S158-S161<br>S162-S165<br>S165<br>S166-S169<br>S170<br>S173-S183   | KANAL KATERLERİ KODLAMA SİSTEMİ<br>DIŞ ÇAP KANAL AÇMA TAKIMLARI<br>DIŞ ÇAP KANAL AÇMA İSVEÇ TİPİ KAYAR OTOMAT MAKİNA TAKIMLARI<br>DIŞ ÇAP ALIN KANAL AÇMA TAKIMLARI<br>L TİP ALIN KANAL AÇMA TAKIMLARI<br>KESME VE DERİN KANAL AÇMA LAMALARI<br>KESME VE DERİN KANAL AÇMA LAMA BLOĞU<br>DELİK İÇİ KANAL KATERLERİ  |
| <b>DELİK DELME ve İŞLEME TAKIMLARI</b>  |  |
| S187-S216<br>S218-S219<br>S220<br>S221<br>S222-S224<br>S225-S234  | TAKMA UÇLU MATKAPLAR ve KODLAMA SİSTEMİ<br>DELİK PAHLAMA TAKIMI VE MONTAJ ŞEKLİ<br>EKSANTRİK TAKMA UÇLU MATKAP ADAPTÖRÜ<br>ÖZEL DELİK DELME ve İŞLEME TAKIMI SİPARİŞ FORMU<br>EKONOMİK KEŞİCİLER ve KODLAMA SİSTEMİ<br>AYARLI DELİK İŞLEME BARALARI ve KODLAMA SİSTEMİ   |
| <b>FREZELEME TAKIMLARI</b>  |  |
| S236<br>S237-S238<br>S238<br>S239<br>S240-S266<br>S267-S270<br>S270-S281<br>S281-S293<br>S293-S303<br>S304-S305<br>S306-S307<br>S308<br>S308-S310<br>S310-S311<br>S312-S351<br>S352-S356<br>S357-S359<br>S360-S368<br>S369-S370<br>S371-S372<br>S374-S378 | FREZELEME TAKIMLARI KODLAMA SİSTEMİ<br>S-SİSTEM PAH FREZELER<br>HELİS PAH FREZELEME TAKIMLARI<br>SİLİNDİRİK ALYAN BAŞLI VİDA (DIN 974-1) HAVŞALARINI AÇMA FREZELERİ<br>S-SİSTEM YÜZEY PARMAK FREZELER<br>S-SİSTEM YÜZEY ve KOPYA PARMAK FREZELER<br>S-SİSTEM HIZLI İLERLEMELİ PARMAK FREZELER<br>S-SİSTEM MODÜLER PARMAK FREZELER<br>S-SİSTEM HIZLI İLERLEMELİ MODÜLER PARMAK FREZELER<br>KÜRE UÇLU PARMAK FREZELER<br>MODÜLER KÜRE UÇLU PARMAK FREZELER<br>VIDALI TAKIM TUTUCULARI<br>DIŞ AÇMA FREZELEME TAKIMLARI<br>S-SİSTEM HELİS FREZELER<br>YÜZEY FREZELER<br>YÜZEY ve KOPYA FREZELER<br>C-SİSTEM YÜZEY FREZELER<br>HIZLI İLERLEMELİ FREZELER<br>T KANAL FREZELER<br>DİSK FREZELER<br>FREZELEME TAKIMLARI MONTAJ ÖLÇÜLERİ ve TEKNİK BİLGİLER |
| <b>YEDEK PARÇALAR</b>   |  |
| S380-S393<br>S394-S399  | YEDEK PARÇALAR<br>ÜRÜN GURUPLARINA GÖRE İÇİNDEKİLER  |

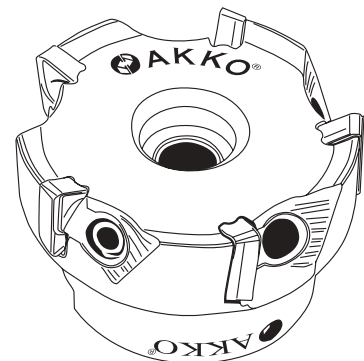
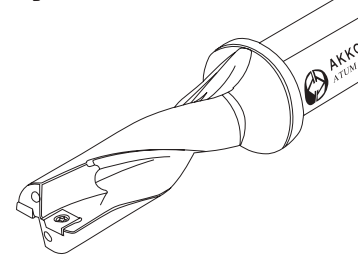
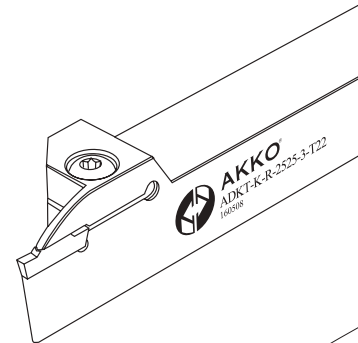
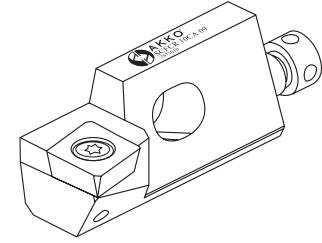
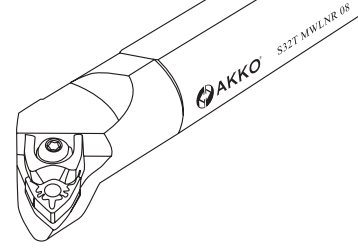
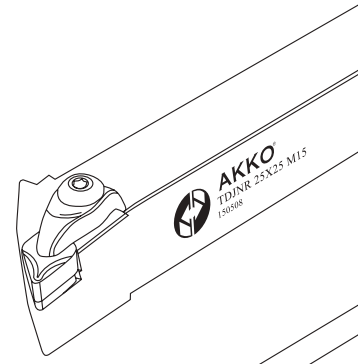

# CONTENTS

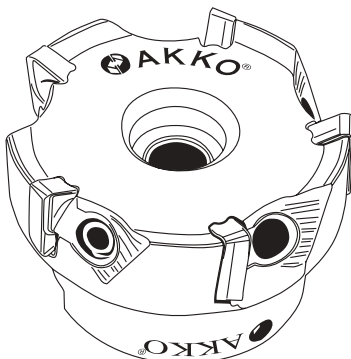
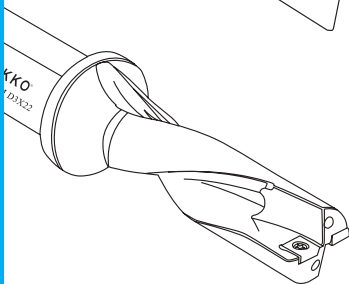
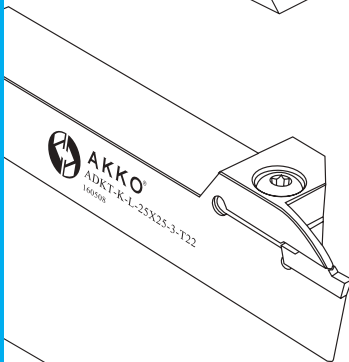
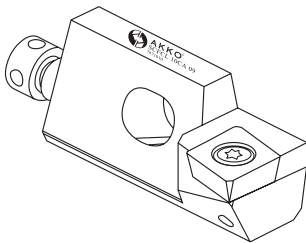
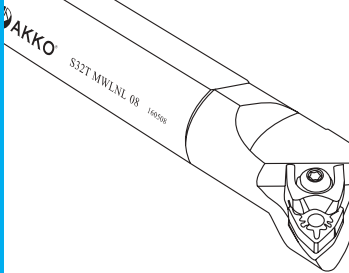
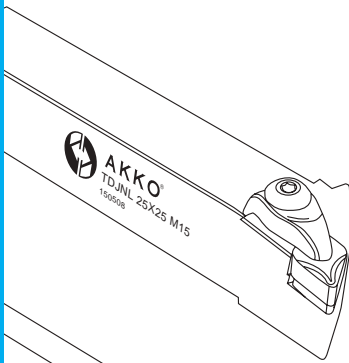

|  |           |
|--|-----------|
| <b>EXTERNAL TURNING TOOLHOLDERS</b>                                    |           |
| EXTERNAL TURNING TOOLHOLDERS DESIGNATION SYSTEM                        | P11       |
| T-SYSTEM EXTERNAL TURNING TOOLHOLDERS                                  | P12-P28   |
| M-SYSTEM EXTERNAL TURNING TOOLHOLDERS                                  | P29-P31   |
| P-SYSTEM EXTERNAL TURNING TOOLHOLDERS                                  | P32-P43   |
| C-SYSTEM EXTERNAL TURNING TOOLHOLDERS                                  | P44-P50   |
| S-SYSTEM EXTERNAL TURNING TOOLHOLDERS                                  | P51-P65   |
| S-SYSTEM TOOLS FOR SWISS TYPE SLIDING AUTOMATIC LATHES                 | P66-P70   |
| SEC TOOLS - SWISS EASY CHANGE  | P70-P73   |
| <b>INTERNAL TURNING TOOLHOLDERS</b>                                    |           |
| BORING BARS DESIGNATION SYSTEM   | P75       |
| T&C SYSTEM BORING BARS   | P76-P82   |
| M-SYSTEM BORING BARS   | P83-P87   |
| P-SYSTEM BORING BARS   | P88-P94   |
| S-SYSTEM BORING BARS   | P95-P112  |
| <b>ANTIVIBRATION TOOLS</b>   |           |
| ANTIVIBRATION TOOL DESIGNATION SYSTEM                                  | P114      |
| ANTIVIBRATION TOOLS  | P115-P120 |
| <b>CARTRIDGE</b>   |           |
| CARTRIDGE DESIGNATION SYSTEM   | P122      |
| S-TYPE ENGINE OVERHAUL CARTRIDGE                                       | P123-P125 |
| S-SYSTEM CARTRIDGE   | P125-P128 |
| P-SYSTEM CARTRIDGE AND PIPE BEVELING and CHAMFERING TOOLS              | P128-P131 |
| <b>THREADING TOOLHOLDERS</b>   |           |
| THREADING TOOLHOLDERS DESIGNATION SYSTEM                               | P133      |
| THREADING TOOLHOLDERS and TECHNICAL INFORMATION                        | P134-P139 |
| <b>GROOVING TOOLHOLDERS</b>  |           |
| GROOVING TOOLHOLDERS DESIGNATION SYSTEM                                | P141      |
| EXTERNAL GROOVING TOOLHOLDERS  | P142-P157 |
| EXTERNAL GROOVING TOOLHOLDERS FOR SWISS TYPE SLIDING AUTOMATIC LATHES  | P158-P161 |
| FACE EXTERNAL GROOVING TOOLHOLDERS                                     | P162-P165 |
| L TYPE FACE EXTERNAL GROOVING TOOLHOLDERS                              | P165      |
| BLADES FOR PARTING AND DEEP GROOVING                                   | P166-P169 |
| BLOCKS FOR PARTING AND DEEP GROOVING BLADES                            | P170      |
| INTERNAL GROOVING TOOLHOLDERS  | P173-P183 |
| <b>DRILLING and HOLEMAKING TOOLS</b>                                   |           |
| U-DRILL SYSTEM and DESIGNATION SYSTEM                                  | P187-P216 |
| DRILL CHAMFERING RING TOOLS and MOUNTING SYSTEM                        | P218-P219 |
| EXCENTRIC ADAPTOR FOR U-DRILLS   | P220      |
| SPECIAL DRILL ORDER FORM   | P221      |
| ECONOMIC CUTTING TOOLS and DESIGNATION SYSTEM                          | P222-P224 |
| ADJUSTABLE BORING HEADS and DESIGNATION SYSTEM                         | P225-P234 |
| <b>MILLING TOOLS</b>   |           |
| MILLING TOOLS DESIGNATION SYSTEM                                       | P236      |
| S-SYSTEM CHAMFERING END MILLS  | P237-P238 |
| HELIX CHAMFER MILLING TOOLS  | P238      |
| COUNTERSINK MILLING TOOL FOR CYLINDRICAL ALLEN HEAD SCREWS (DIN 974-1) | P239      |
| S-SYSTEM END MILLS   | P240-P266 |
| S-SYSTEM FACE and COPY END MILLS                                       | P267-P270 |
| S-SYSTEM HIGHFEED END MILLS  | P270-P281 |
| S-SYSTEM MODULAR END MILLS (SCREW TYPE TOOLS)                          | P281-P293 |
| S-SYSTEM MODULAR (SCREW TYPE) HIGHFEED END MILLS                       | P293-P303 |
| BALL NOSE MILLS  | P304-P305 |
| BALL NOSE MODULAR (SCREW TYPE) END MILLS                               | P306-P307 |
| SCREWED TOOL HOLDERS   | P308      |
| THREAD MILLING TOOLS   | P308-P310 |
| S-SYSTEM HELIX END MILL  | P310-P311 |
| FACE MILLING   | P312-P351 |
| FACE and COPY MILLING TOOLS  | P352-P356 |
| C-SYSTEM FACE MILLING  | P357-P359 |
| HIGH FEED MILLING TOOLS  | P360-P368 |
| T SLOT MILLING   | P369-P370 |
| DISC MILLING   | P371-P372 |
| MOUNTING REFERENCE FOR MILLING CUTTERS and TECHNICAL INFORMATION       | P374-P378 |
| <b>SPARE PARTS</b>   |           |
| SPARE PARTS  | P380-P393 |
| INDEX  | P394-P399 |

|         |  |
|---------|--|
|         | <b>DREHEN - AUßENDREHHALTER</b>                      |
| P11     | BEZEICHNUNGSSCHLÜSSEL FÜR DREHALTER AUßENBEARBEITUNG |
| P12-P28 | T-SYSTEM AUSSEN - DREHHALTER                         |
| P29-P31 | M-SYSTEM AUSSEN - DREHHALTER                         |
| P32-P43 | P SYSTEM AUSSEN - DREHHALTER                         |
| P44-P50 | C SYSTEM AUSSEN - DREHHALTER                         |
| P51-P65 | S SYSTEM AUSSEN - DREHHALTER                         |
| P66-P70 | S-SYSTEM FÜR LANGDREHAUTOMATEN                       |
| P70-P73 | SEC TOOLS  |

|          |   |
|----------|---|
|          | <b>DREHWERKZEUGE FÜR DIE INNENBEARBEITUNG</b> |
| P75      | BOHRSTANGE BEZEICHNUNGSSYSTEM                 |
| P76-P82  | T&C SYSTEM BOHRSTANGE                         |
| P83-P87  | M-SYSTEM BOHRSTANGE                           |
| P88-P94  | P- SYSTEM BOHRSTANGE                          |
| P95-P112 | S- SYSTEM BOHRSTANGE                          |

|           |                                       |
|-----------|---------------------------------------|
|           | <b>ANTIVIBRATION TOOLS</b>            |
| P114      | ANTIVIBRATION TOOL DESIGNATION SYSTEM |
| P115-P120 | ANTIVIBRATION TOOLS                   |

|           |   |
|-----------|---|
|           | <b>KURZDREHHALTER</b>                               |
| P122      | KURZDREHHALTER BEZEICHNUNGSSYSTEM                   |
| P123-P125 | S-SYSTEM KURZDREHHALTER FÜR DIE MOTORINSTANDHALTUNG |
| P125-P128 | S-SYSTEM KURZDREHHALTER                             |
| P128-P131 | S-SYSTEM KURZDREHHALTER                             |

|           |                                       |
|-----------|---------------------------------------|
|           | <b>GEWINDE DREHHALTER</b>             |
| P133      | GEWINDE DREHHALTER BEZEICHNUNGSSYSTEM |
| P134-P139 | AUSSEN-GEWINDEDREHHALTER              |

|           |  |
|-----------|--|
|           | <b>STECHHALTER</b>                                   |
| P141      | STECHHALTER BEZEICHNUNGSSYSTEM                       |
| P142-P157 | AUßEN-STECHHALTER                                    |
| P158-P161 | WERKZEUGE ZUR STECHBEARBEITUNG AUF LANGDREHAUTOMATEN |
| P162-P165 | AXIAL-STECHHALTER                                    |
| P165      | AXIAL STECHHALTER L-TYPE                             |
| P166-P169 | STECHSCHWERT FÜR ABSTECHEN UND TIEFE EINSTICHE       |
| P170      | SPANNBLOCK FÜR STECHSCHWERT                          |
| P173-P183 | INNEN-STECHHALTER                                    |

|           |  |
|-----------|--|
|           | <b>BOHRWERKZEUGE</b>   |
| P187-P216 | VOLLBOHRER / BEZEICHNUNGSSYSTEM FÜR VOLLBOHRER   |
| P218-P219 | FASRING FÜR VOLLBOHRER   |
| P220      | EXENTRISCHER ADAPTER FÜR WENDEPLATTENBOHRER  |
| P221      | BESTELLFORMULAR FÜR SONDERBOHRER   |
| P222-P224 | BEZEICHNUNGSSYSTEM FÜR MULTIFUNKTIONALES DREH-UND BOHRWERKZEUG / BOHREN, INNEN-UND AUßENDREHEN |
| P225-P234 | BEZEICHNUNGSSYSTEM FÜR EINSTELLBARE SPINDELKÖPFE / EINSTELLBARE SPINDELKÖPFE                   |

|           |  |
|-----------|--|
|           | <b>FRÄSWERKZEUGE</b>                               |
| P236      | BEZEICHNUNGSSYSTEM FÜR FRÄSER                      |
| P237-P238 | S-SYSTEM FASFRÄSER                                 |
| P238      | HELIX-FASFRÄSER                                    |
| P239      | SENKWERKZEUG FÜR ZYLINDERKOPFSCHRAUBEN (DIN 974-1) |
| P240-P266 | S-SYSTEM SCHAFTFRÄSER                              |
| P267-P270 | S-SYSTEM KOPIER- UND SCHAFTFRÄSER                  |
| P270-P281 | S-SYSTEM HOCHVORSCHUB- SCHAFTFRÄSER                |
| P281-P293 | S-SYSTEM EINSCHRAUBFRÄSER                          |
| P293-P303 | S-SYSTEM HOCHVORSCHUB-EINSCHRAUBFRÄSER             |
| P304-P305 | KUGELKOPIERFRÄSER                                  |
| P306-P307 | MODULARE EINSCHRAUB-KUGELFRÄSER                    |
| P308      | AUFNAHME FÜR EINSCHRAUBFRÄSER                      |
| P308-P310 | GEWINDEFÄSERWERKZEUGE                              |
| P310-P311 | S-SYSTEM WENDELSCHAFTFRÄSER                        |
| P312-P351 | PLAN UND ECKMESSERKÖPFE                            |
| P352-P356 | MESSERKÖPFE FÜR RUNDE WENDESCHNEIDPLATTEN          |
| P357-P359 | PLAN UND ECKMESSERKÖPFE                            |
| P360-P368 | HOCHVORSCHUBFRÄSER                                 |
| P369-P370 | T-NUTENFRÄSER                                      |
| P371-P372 | SCHEIBENFRÄSER                                     |
| P374-P378 | ABMESSUNGEN DER AUFNAHMEBOHRUNGEN FÜR MESSERKÖPFE  |

|           |                    |
|-----------|--------------------|
|           | <b>ERSATZTEILE</b> |
| P380-P393 | ERSATZTEILE        |
| P394-P399 | INDEX              |

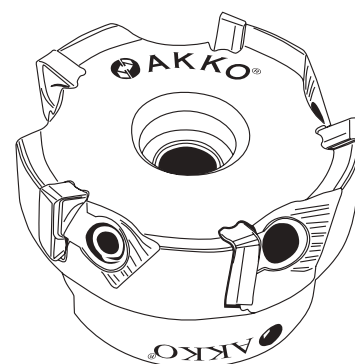
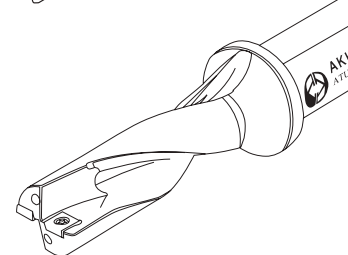
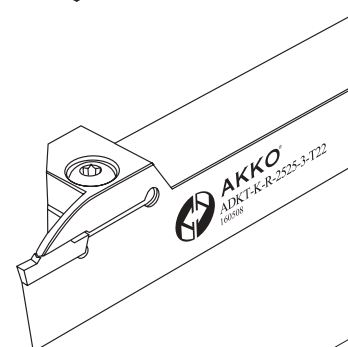
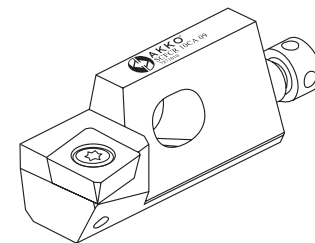
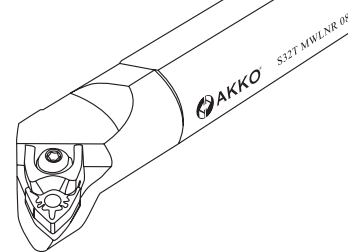



**konusulan**  
**the spoken kalite...**  
**quality...**





**DIŞ TORNA TAKIMLARI**  
*EXTERNAL TURNING TOOLHOLDERS*  
*DREHEN - AUßENDREHHALTER*





**1** Sıkma Tipi / Method of Mounting of Insert / Klemmsystem

**P** **S** **K** **N** **R**

1 2 3 4 5

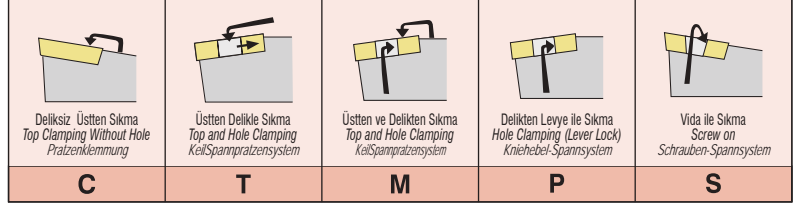

**2** Uç Tipi / Type of Insert / Plattenform

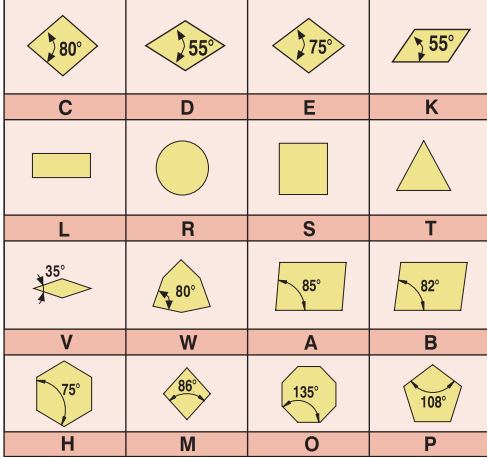

**3** Yanaşma Açısı / Tool Holder Shape Bar Geometry / Anstellwinkel

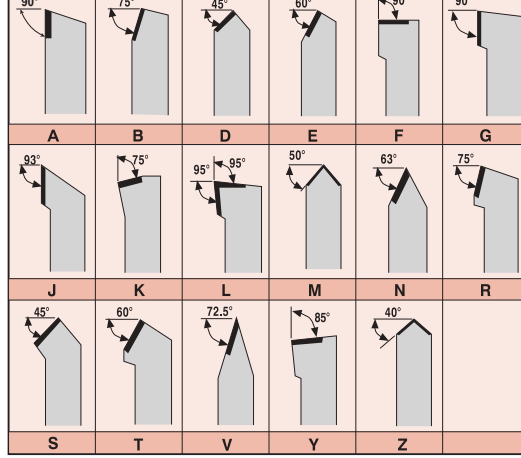

**4** Serbest Uç Açısı / Insert Clearance Angle / Freiwinkel / Freiwinkel

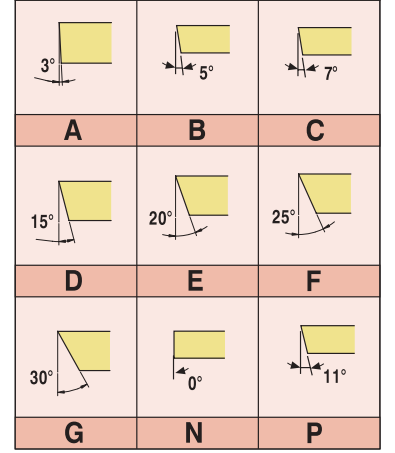

**5** Kesme Yönü / Cutting Direction / Halterausführung

**25** **25 -** **M** **12** **C**

6 7 8 9 10

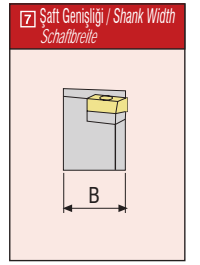
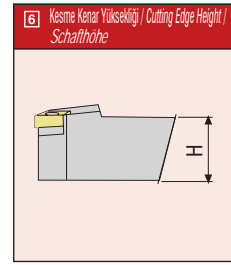
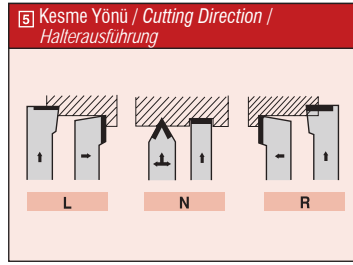

**8** Şaft Boyu / Shank Length / Schaftlänge

LF

|        |         |         |           |
|--------|---------|---------|-----------|
| A - 32 | H - 100 | Q - 180 | x-special |
| B - 40 | J - 110 | R - 200 |           |
| C - 50 | K - 125 | S - 250 |           |
| D - 60 | L - 140 | T - 300 |           |
| E - 70 | M - 150 | U - 350 |           |
| F - 80 | N - 160 | V - 400 |           |
| G - 90 | P - 170 | W - 450 |           |

(mm)

**9** Kesme Kenar Uzunluğu / Cutting Edge Length / Schneidkantenlänge

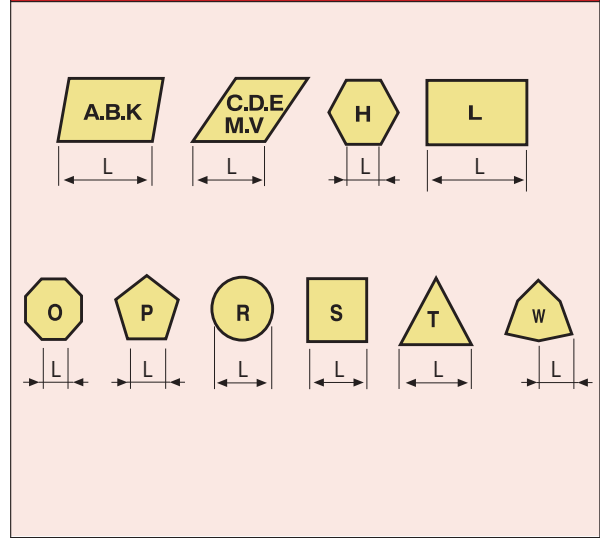

**10** Baskı Pabucu / Wedge Clamp / Spannpratze

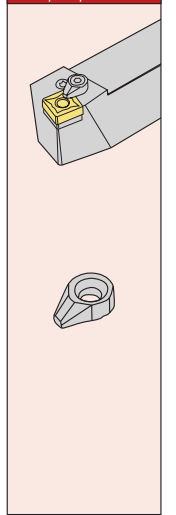



*konusulan  
the spoken kalite...  
quality...*

# T-SİSTEM

**T-SİSTEM DIŞ TORNA KATERLERİ**

*T-SYSTEM EXTERNAL TURNING TOOLHOLDERS*

*T-SYSTEM AUSSEN - DREHHALTER MIT INNENKÜHLUNG*



**DETAYLI BİLGİ İÇİN BARKODU OKUTUNUZ**  
*SCAN ME FOR MORE DETAILS*  
*FÜR DETAILS BITTE DEN QR CODE SCANNEN*

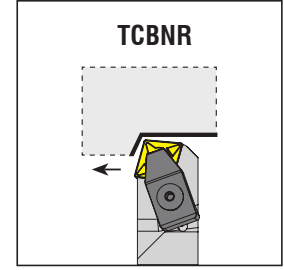
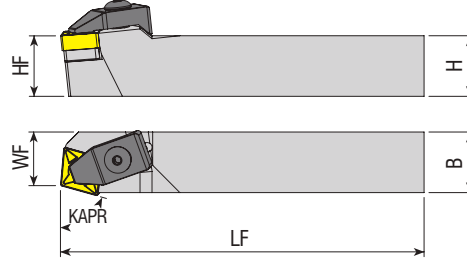

| Takım Kodu<br>Ordering Code<br>Bestell-Bezeichnung | Stok<br>Stock<br>Lager |   | Takım Ölçüleri (mm)<br>Dimension (mm)<br>Abmessung (mm) |    |     |    | Kesici Uç<br>Insert<br>Wendeschneidplatte | Yedek Parçaları / Spare Parts / Ersatzteile |  |                             |   |                         |                      |  |  |  |
|--|------------------------|---|---|----|-----|----|---|---|--|-----------------------------|---|-------------------------|----------------------|--|--|--|
|  | R                      | L | HF=H  | B  | LF  | WF |   | Baskı Pabucu<br>Wedge Clamp<br>Spannpratze  | Pabuç Vidası<br>Clamp Screw<br>Klemmschraube | Altlık<br>Shim<br>Unterlage | Altlık Vidası<br>Shim Screw<br>Schraube für Unterlage | Segman<br>Ring<br>Feder | Pul<br>Stamp<br>Ring | Anahtar<br>Allen Key<br>Innerschloßschlüssel |  |  |
|  |                        |   |   |    |     |    |   |   |  |                             |   |                         |                      |  |  |  |
| TCBNR/L 2525 M16                                   | ●                      | ● | 25  | 25 | 150 | 22 |   |   |  |                             |   |                         |                      |  |  |  |
|  |                        |   |   |    |     |    | <b>CNM. 1606..</b>                        | ATK-04                                      | AKV-19-M7x25                                 | AACN-3-0002                 | AAV-05-M6x15  | AS-02                   | ABPL-02              | AAL-05-4                                     |  |  |

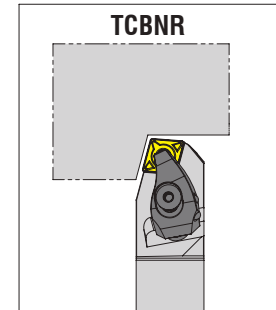
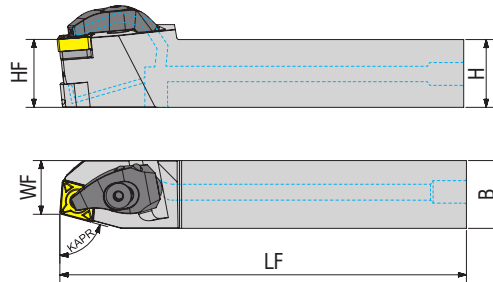

| Takım Kodu<br>Ordering Code<br>Bestell-Bezeichnung | Stok<br>Stock<br>Lager |   | Takım Ölçüleri (mm)<br>Dimension (mm)<br>Abmessung (mm) |    |     |    | Kesici Uç<br>Insert<br>Wendeschneidplatte | Yedek Parçaları / Spare Parts / Ersatzteile |  |                             |   |                        |                        |  |  |  |  |
|--|------------------------|---|---|----|-----|----|---|---|--|-----------------------------|---|------------------------|------------------------|--|--|--|--|
|  | R                      | L | HF=H  | B  | LF  | WF |   | Baskı Pabucu<br>Wedge Clamp<br>Spannpratze  | Pabuç Vidası<br>Clamp Screw<br>Klemmschraube | Altlık<br>Shim<br>Unterlage | Altlık Vidası<br>Shim Screw<br>Schraube für Unterlage | Yay<br>Spring<br>Feder | Oring<br>Ring<br>Feder | Sızdırmaz Vida<br>Threaded Pin<br>Резьбовой Винт | Anahtar<br>Allen Key<br>Innerschloßschlüssel |  |  |
|  |                        |   |   |    |     |    |   |   |  |                             |   |                        |                        |  |  |  |  |
| TCBNR/L 2020 K12-H                                 | ○                      | ○ | 20  | 20 | 125 | 16 |   |   |  |                             |   |                        |                        |  |  |  |  |
| 2525 M12-H   | ○                      | ○ | 25  | 25 | 150 | 20 | <b>CNM. 1204..</b>                        | ATKH-01-R                                   | AKV-33-M6x22                                 | AACN-3-0001                 | AAV-02-M5x12  | AKY-01                 | AXR-01                 | 2705-G1/8x5.5                                    | AAL-03-3                                     |  |  |
| 3232 P12-H   | ○                      | ○ | 32  | 32 | 170 | 25 |   | ATKH-02-L                                   |  |                             |   |                        |                        |  |  |  |  |

R: Sağ / Right / Rechts L: Sol / Left / Links

● Stokta / In Stock / Auf Lager ○ Stokta Yok / Non Stock Item / Kein Lagerartikel, Lieferzeit auf Anfrage

Sipariş Örneği/Ordering Example/Bestellbeispiel

1 ad./pcs./stück TCBNR/L 2525 M16

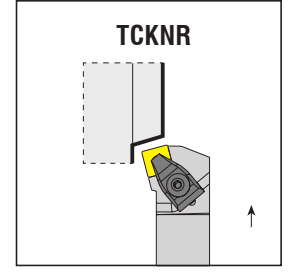
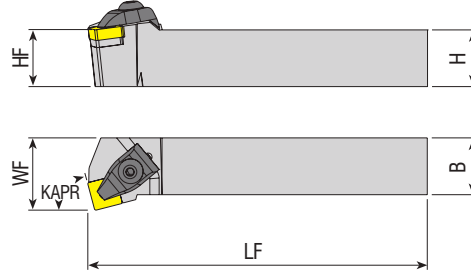

| Takım Kodu<br>Ordering Code<br>Bestell-Bezeichnung | Stok<br>Stock<br>Lager |   | Takım Ölçüleri (mm)<br>Dimension (mm)<br>Abmessung (mm) |    |     |    | Kesici Uç<br>Insert<br>Wendeschneidplatte | Yedek Parçaları / Spare Parts / Ersatzteile |  |                            |  |                         |                      |   |
|--|------------------------|---|---|----|-----|----|---|---|--|----------------------------|--|-------------------------|----------------------|---|
|  | R                      | L | HF=H  | B  | LF  | WF |   | Baskı Pabucu<br>Wedge Clamp<br>Spannpratze  | Pabuç Vidası<br>Clamp Screw<br>Klemmschraube | Altık<br>Shim<br>Unterlage | Altık Vidası<br>Shim Screw<br>Schraube für Unterlage | Segman<br>Ring<br>Feder | Pul<br>Stamp<br>Ring | Anahtar<br>Allen Key<br>Innensechskantschlüssel |
|  |                        |   |   |    |     |    |   |   |  |                            |  |                         |                      |   |
| TCKNR/L 2020 K12                                   | ●                      | ● | 20  | 20 | 125 | 25 | CNM. 1204..                               |   |  |                            |  |                         |                      |   |
| 2525 M12   | ●                      | ● | 25  | 25 | 150 | 32 |   |   |  |                            |  |                         |                      |   |
| 3232 P12   | ●                      | ● | 32  | 32 | 170 | 40 |   |   |  |                            |  |                         |                      |   |
| 2525 M16   | ●                      | ● | 25  | 25 | 150 | 32 | CNM. 1606..                               |   |  |                            |  |                         |                      |   |
| 3232 P16   | ●                      | ● | 32  | 32 | 170 | 40 |   |   |  |                            |  |                         |                      |   |

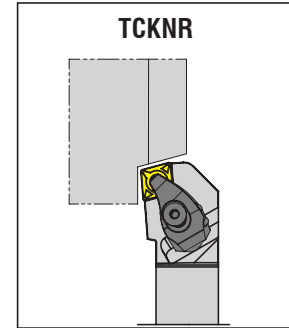
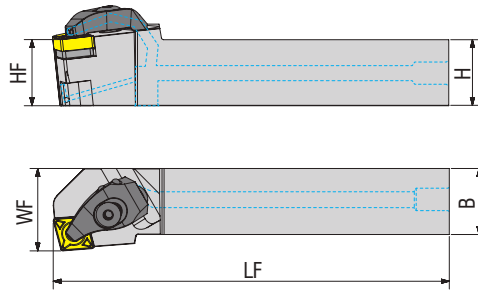

| Takım Kodu<br>Ordering Code<br>Bestell-Bezeichnung | Stok<br>Stock<br>Lager |   | Takım Ölçüleri (mm)<br>Dimension (mm)<br>Abmessung (mm) |    |     |    | Kesici Uç<br>Insert<br>Wendeschneidplatte | Yedek Parçaları / Spare Parts / Ersatzteile |  |                            |  |                        |                        |  |   |
|--|------------------------|---|---|----|-----|----|---|---|--|----------------------------|--|------------------------|------------------------|--|---|
|  | R                      | L | HF=H  | B  | LF  | WF |   | Baskı Pabucu<br>Wedge Clamp<br>Spannpratze  | Pabuç Vidası<br>Clamp Screw<br>Klemmschraube | Altık<br>Shim<br>Unterlage | Altık Vidası<br>Shim Screw<br>Schraube für Unterlage | Yay<br>Spring<br>Feder | Oring<br>Ring<br>Feder | Sızdırmaz Vida<br>Threaded Pin<br>Резьбовой Винт | Anahtar<br>Allen Key<br>Innensechskantschlüssel |
|  |                        |   |   |    |     |    |   |   |  |                            |  |                        |                        |  |   |
| TCKNR/L 2020 K12-H                                 | ○                      | ○ | 20  | 20 | 125 | 25 | CNM. 1204..                               |   |  |                            |  |                        |                        |  |   |
| 2525 M12-H   | ○                      | ○ | 25  | 25 | 150 | 32 |   |   |  |                            |  |                        |                        |  |   |
| 3232 P12-H   | ○                      | ○ | 32  | 32 | 170 | 40 |   |   |  |                            |  |                        |                        |  |   |
|  |                        |   |   |    |     |    |   | ATKH-01-R                                   | AKV-33-M6x22                                 | AACN-3-0001                | AAV-13-M5x8  | AKY-01                 | AXR-01                 | 2705-G1/8x5.5                                    | AAL-03-3  |
|  |                        |   |   |    |     |    |   | ATKH-02-L                                   |  |                            |  |                        |                        |  |   |

R: Sağ / Right / Rechts L: Sol / Left / Links

● Stokta / In Stock / Auf Lager ○ Stokta Yok / Non Stock Item / Kein Lagerartikel, Lieferzeit auf Anfrage

Sipariş Örneği/Ordering Example/Bestellbeispiel

1 ad./pcs./stück TCKNR 2020 K12

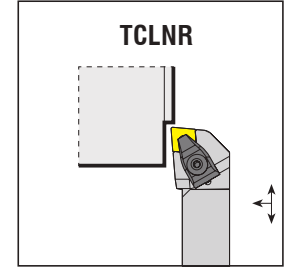
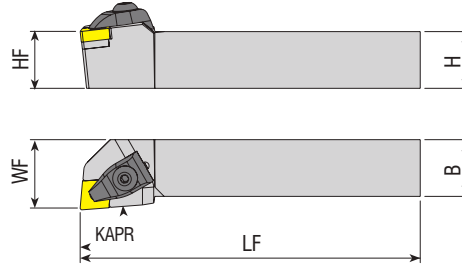

**Takım Kodu**  
**Ordering Code**  
**Bestell-Bezeichnung**

| Takım Kodu<br>Ordering Code<br>Bestell-Bezeichnung | Stok<br>Stock<br>Lager |   | Takım Ölçüleri (mm)<br>Dimension (mm)<br>Abmessung (mm) |    |     |    | Kesici Uç<br>Insert<br>Wendeschneidplatte | Yedek Parçaları / Spare Parts / Ersatzteile |  |                             |   |                         |                      |   |  |
|--|------------------------|---|---|----|-----|----|---|---|--|-----------------------------|---|-------------------------|----------------------|---|--|
|  | R                      | L | HF=H  | B  | LF  | WF |   | Baskı Pabuçu<br>Wedge Clamp<br>Spannpratze  | Pabuç Vidası<br>Clamp Screw<br>Klemmschraube | Altlık<br>Shim<br>Unterlage | Altlık Vidası<br>Shim Screw<br>Schraube für Unterlage | Segman<br>Ring<br>Feder | Pul<br>Stamp<br>Ring | Anahtar<br>Allen Key<br>Innensechskantschlüssel |  |
| <b>TCLNR/L 2020 K12</b>                            | ●                      | ● | 20  | 20 | 125 | 25 |   |   |  |                             |   |                         |                      |   |  |
| <b>2525 M12</b>                                    | ●                      | ● | 25  | 25 | 150 | 32 |   |   |  |                             |   |                         |                      |   |  |
| <b>3232 P12</b>                                    | ●                      | ● | 32  | 32 | 170 | 40 |   |   |  |                             |   |                         |                      |   |  |
| <b>4040 S12</b>                                    | ●                      | ● | 40  | 40 | 250 | 50 |   |   |  |                             |   |                         |                      |   |  |
| <b>5050 S12</b>                                    | ●                      | ● | 50  | 50 | 250 | 63 |   |   |  |                             |   |                         |                      |   |  |
| <b>2525 M16</b>                                    | ●                      | ● | 25  | 25 | 150 | 32 |   |   |  |                             |   |                         |                      |   |  |
| <b>3232 P16</b>                                    | ●                      | ● | 32  | 32 | 170 | 40 |   |   |  |                             |   |                         |                      |   |  |

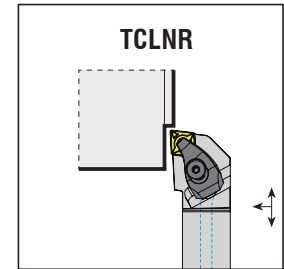
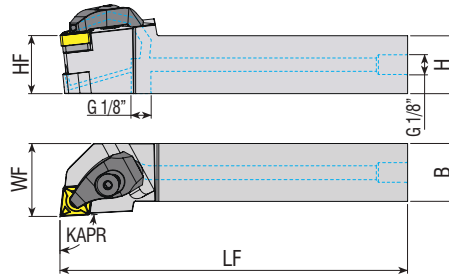

**Takım Kodu**  
**Ordering Code**  
**Bestell-Bezeichnung**

| Takım Kodu<br>Ordering Code<br>Bestell-Bezeichnung | Stok<br>Stock<br>Lager |   | Takım Ölçüleri (mm)<br>Dimension (mm)<br>Abmessung (mm) |    |     |    | Kesici Uç<br>Insert<br>Wendeschneidplatte | Yedek Parçaları / Spare Parts / Ersatzteile |  |                             |   |                        |                        |  |   |
|--|------------------------|---|---|----|-----|----|---|---|--|-----------------------------|---|------------------------|------------------------|--|---|
|  | R                      | L | HF=H  | B  | LF  | WF |   | Baskı Pabuçu<br>Wedge Clamp<br>Spannpratze  | Pabuç Vidası<br>Clamp Screw<br>Klemmschraube | Altlık<br>Shim<br>Unterlage | Altlık Vidası<br>Shim Screw<br>Schraube für Unterlage | Yay<br>Spring<br>Feder | Oring<br>Ring<br>Feder | Sızdırmaz Vida<br>Threaded Pin<br>Резьбовой Винт | Anahtar<br>Allen Key<br>Innensechskantschlüssel |
| <b>TCLNR/L 2020 K12-H</b>                          | ●                      | ● | 20  | 20 | 125 | 25 |   |   |  |                             |   |                        |                        |  |   |
| <b>2525 M12-H</b>                                  | ●                      | ● | 25  | 25 | 150 | 32 |   |   |  |                             |   |                        |                        |  |   |
| <b>3232 P12-H</b>                                  | ●                      | ● | 32  | 32 | 170 | 40 |   |   |  |                             |   |                        |                        |  |   |

R: Sağ / Right / Rechts L: Sol / Left / Links

● Stokta / In Stock / Auf Lager ○ Stokta Yok / Non Stock Item / Kein Lagerartikel, Lieferzeit auf Anfrage

Sipariş Örneği/Ordering Example/Bestellbeispiel

1 ad./pcs./stück TCLNR 2020 K12

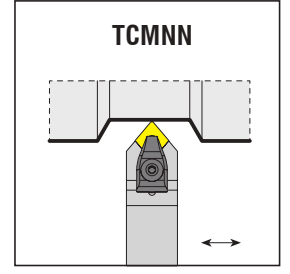
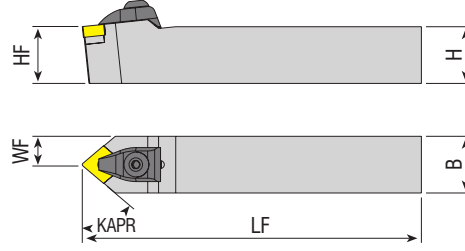

| Takım Kodu<br>Ordering Code<br>Bestell-Bezeichnung | Stok<br>Stock<br>Lager | Takım Ölçüleri (mm)<br>Dimension (mm)<br>Abmessung (mm) |    |     |      | Kesici Uç<br>Insert<br>Wendeschneidplatte | Yedek Parçaları / Spare Parts / Ersatzteile |  |                             |   |                         |                      |   |  |
|--|------------------------|---|----|-----|------|---|---|--|-----------------------------|---|-------------------------|----------------------|---|--|
|  |                        | HF=H  | B  | LF  | WF   |   | Baskı Pabucu<br>Wedge Clamp<br>Spannpratze  | Pabuç Vidası<br>Clamp Screw<br>Klemmschraube | Altlık<br>Shim<br>Unterlage | Altlık Vidası<br>Shim Screw<br>Schraube für Unterlage | Segman<br>Ring<br>Feder | Pul<br>Stamp<br>Ring | Anahtar<br>Allen Key<br>Innensechskantschlüssel |  |
| <b>TCMNN 1616 H12</b>                              | ●                      | 16  | 16 | 100 | 8    | <b>CNM. 1204..</b>                        |   |  |                             |   |                         |                      |   |  |
| <b>2020 K12</b>                                    | ●                      | 20  | 20 | 125 | 10   |   |   |  |                             |   |                         |                      |   |  |
| <b>2525 M12</b>                                    | ●                      | 25  | 25 | 150 | 12.5 |   |   |  |                             |   |                         |                      |   |  |
| <b>3232 P12</b>                                    | ●                      | 32  | 32 | 170 | 16   |   |   |  |                             |   |                         |                      |   |  |
| <b>2525 M16</b>                                    | ●                      | 25  | 25 | 150 | 12.5 | <b>CNM. 1606..</b>                        |   |  |                             |   |                         |                      |   |  |
| <b>3232 P16</b>                                    | ●                      | 32  | 32 | 170 | 16   |   |   |  |                             |   |                         |                      |   |  |
| <b>4040 S16</b>                                    | ○                      | 40  | 40 | 250 | 20   |   |   |  |                             |   |                         |                      |   |  |

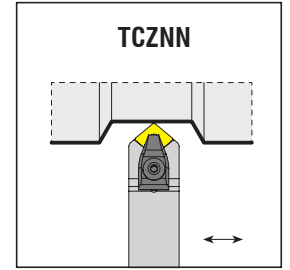
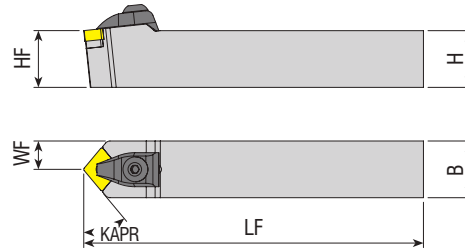
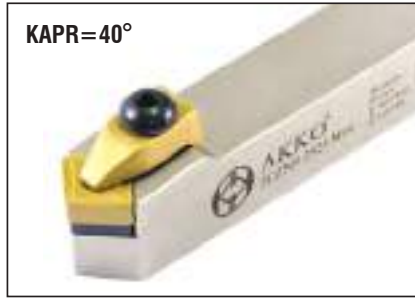

| Takım Kodu<br>Ordering Code<br>Bestell-Bezeichnung | Stok<br>Stock<br>Lager | Takım Ölçüleri (mm)<br>Dimension (mm)<br>Abmessung (mm) |    |     |      | Kesici Uç<br>Insert<br>Wendeschneidplatte | Yedek Parçaları / Spare Parts / Ersatzteile |  |                             |   |                         |                      |   |  |
|--|------------------------|---|----|-----|------|---|---|--|-----------------------------|---|-------------------------|----------------------|---|--|
|  |                        | HF=H  | B  | LF  | WF   |   | Baskı Pabucu<br>Wedge Clamp<br>Spannpratze  | Pabuç Vidası<br>Clamp Screw<br>Klemmschraube | Altlık<br>Shim<br>Unterlage | Altlık Vidası<br>Shim Screw<br>Schraube für Unterlage | Segman<br>Ring<br>Feder | Pul<br>Stamp<br>Ring | Anahtar<br>Allen Key<br>Innensechskantschlüssel |  |
| <b>TCZNN 2020 K12</b>                              | ●                      | 20  | 20 | 125 | 10   | <b>CNM. 1204..</b>                        |   |  |                             |   |                         |                      |   |  |
| <b>2525 M12</b>                                    | ●                      | 25  | 25 | 150 | 12.5 |   |   |  |                             |   |                         |                      |   |  |
| <b>3232 P12</b>                                    | ●                      | 32  | 32 | 170 | 16   |   |   |  |                             |   |                         |                      |   |  |
| <b>2525 M16</b>                                    | ●                      | 25  | 25 | 150 | 12.5 |   |   |  |                             |   |                         |                      |   |  |
| <b>3232 P16</b>                                    | ●                      | 32  | 32 | 170 | 16   | <b>CNM. 1606..</b>                        |   |  |                             |   |                         |                      |   |  |

R: Sağ / Right / Rechts L: Sol / Left / Links

● Stokta / In Stock / Auf Lager ○ Stokta Yok / Non Stock Item / Kein Lagerartikel, Lieferzeit auf Anfrage

Sipariş Örneği/Ordering Example/Bestellbeispiel

1 ad./pcs./stück TCMNN 1616 H12



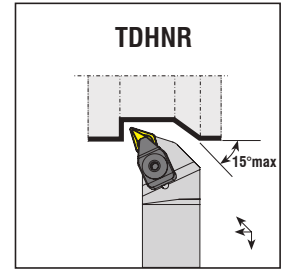
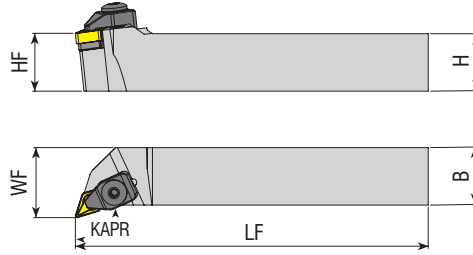

| Takım Kodu<br>Ordering Code<br>Bestell-Bezeichnung | Stok<br>Stock<br>Lager |   | Takım Ölçüleri (mm)<br>Dimension (mm)<br>Abmessung (mm) |    |     |    | Kesici Uç<br>Insert<br>Wendeschneidplatte | Yedek Parçaları / Spare Parts / Ersatzteile |  |                             |   |                         |                      |   |                    |        |              |             |              |       |         |          |
|--|------------------------|---|---|----|-----|----|---|---|--|-----------------------------|---|-------------------------|----------------------|---|--------------------|--------|--------------|-------------|--------------|-------|---------|----------|
|  | R                      | L | HF=H  | B  | LF  | WF |   | Baskı Pabucu<br>Wedge Clamp<br>Spannpratze  | Pabuç Vidası<br>Clamp Screw<br>Klemmschraube | Altlık<br>Shim<br>Unterlage | Altlık Vidası<br>Shim Screw<br>Schraube für Unterlage | Segman<br>Ring<br>Feder | Pul<br>Stamp<br>Ring | Anahtar<br>Allen Key<br>Innensechskantschlüssel |                    |        |              |             |              |       |         |          |
|  |                        |   |   |    |     |    |   |   |  |                             |   |                         |                      |   |                    |        |              |             |              |       |         |          |
| <b>TDHNR/L 2525 M11</b>                            | ○                      | ● | 25  | 25 | 150 | 31 | <b>DNM. 1104..</b>                        | ATK-01                                      | AKV-01-M5x22                                 | AADN-2-0001                 | AAV-04-M5x12  | -                       |                      |   |                    |        |              |             |              |       |         |          |
| <b>2020 K15</b>                                    | ●                      | ● | 20  | 20 | 125 | 25 |   |   |  |                             |   |                         |                      |   |                    |        |              |             |              |       |         |          |
| <b>2525 M15</b>                                    | ●                      | ● | 25  | 25 | 150 | 32 |   |   |  |                             |   |                         |                      |   | <b>DNM. 1506..</b> | ATK-02 | AKV-30-M6x22 | AADN-3-0001 | AAV-02-M5x12 | AS-01 | ABPL-01 | AAL-03-3 |
| <b>3232 P15</b>                                    | ●                      | ● | 32  | 32 | 170 | 40 |   |   |  |                             |   |                         |                      |   |                    |        |              |             |              |       |         |          |

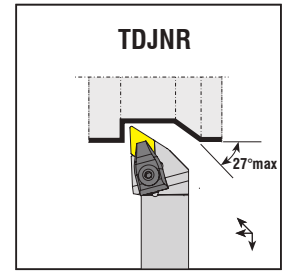
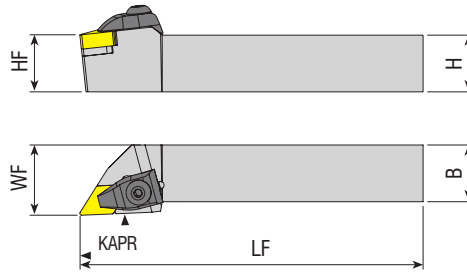

| Takım Kodu<br>Ordering Code<br>Bestell-Bezeichnung | Stok<br>Stock<br>Lager |   | Takım Ölçüleri (mm)<br>Dimension (mm)<br>Abmessung (mm) |    |     |    | Kesici Uç<br>Insert<br>Wendeschneidplatte | Yedek Parçaları / Spare Parts / Ersatzteile |  |                             |   |                         |                      |   |
|--|------------------------|---|---|----|-----|----|---|---|--|-----------------------------|---|-------------------------|----------------------|---|
|  | R                      | L | HF=H  | B  | LF  | WF |   | Baskı Pabucu<br>Wedge Clamp<br>Spannpratze  | Pabuç Vidası<br>Clamp Screw<br>Klemmschraube | Altlık<br>Shim<br>Unterlage | Altlık Vidası<br>Shim Screw<br>Schraube für Unterlage | Segman<br>Ring<br>Feder | Pul<br>Stamp<br>Ring | Anahtar<br>Allen Key<br>Innensechskantschlüssel |
|  |                        |   |   |    |     |    |   |   |  |                             |   |                         |                      |   |
| <b>TDJNR/L 1616 H11</b>                            | ●                      | ● | 16  | 16 | 100 | 20 | <b>DNM. 1104..</b>                        | ATK-01                                      | AKV-01-M5x22                                 | AADN-2-0001                 | AAV-04-M5x12  | -                       |                      |   |
| <b>2020 K11</b>                                    | ●                      | ● | 20  | 20 | 125 | 25 |   |   |  |                             |   |                         |                      |   |
| <b>2525 M11</b>                                    | ●                      | ● | 25  | 25 | 150 | 32 |   |   |  |                             |   |                         |                      |   |
| <b>2020 K15</b>                                    | ●                      | ● | 20  | 20 | 125 | 25 | <b>DNM. 1506..</b>                        | ATK-02                                      | AKV-30-M6x22                                 | AADN-3-0001                 | AAV-02-M5x12  | AS-01                   | ABPL-01              | AAL-03-3  |
| <b>2525 M15</b>                                    | ●                      | ● | 25  | 25 | 150 | 32 |   |   |  |                             |   |                         |                      |   |
| <b>3232 P15</b>                                    | ●                      | ● | 32  | 32 | 170 | 40 |   |   |  |                             |   |                         |                      |   |
| <b>4040 S15</b>                                    | ●                      | ● | 40  | 40 | 250 | 50 |   |   |  |                             |   |                         |                      |   |
| <b>5050 S15</b>                                    | ○                      | ○ | 50  | 50 | 250 | 63 | <b>DNM. 1504..</b>                        | ATK-02                                      | AKV-30-M6x22                                 | AADN-2-0003                 | AAV-02-M5x12  | AS-01                   |                      |   |
| <b>2020 K1504</b>                                  | ●                      | ● | 20  | 20 | 125 | 25 |   |   |  |                             |   |                         |                      |   |
| <b>2525 M1504</b>                                  | ●                      | ● | 25  | 25 | 150 | 32 |   |   |  |                             |   |                         |                      |   |
| <b>3232 P1504</b>                                  | ●                      | ● | 32  | 32 | 170 | 40 |   |   |  |                             |   |                         |                      |   |
| <b>4040 S1504</b>                                  | ●                      | ● | 40  | 40 | 250 | 50 |   |   |  |                             |   |                         |                      |   |

R: Sağ / Right / Rechts L: Sol / Left / Links

● Stokta / In Stock / Auf Lager ○ Stokta Yok / Non Stock Item / Kein Lagerartikel, Lieferzeit auf Anfrage

Sipariş Örneği/Ordering Example/Bestellbeispiel  
1 ad./pcs./stück TDHNR 2525 M11

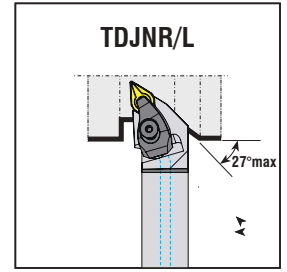
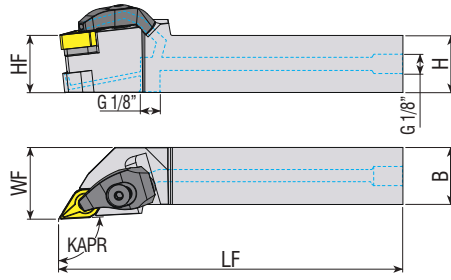

| Takım Kodu<br>Ordering Code<br>Bestell-Bezeichnung | Stok<br>Stock<br>Lager |   | Takım Ölçüleri (mm)<br>Dimension (mm)<br>Abmessung (mm) |    |     |    | Kesici Uç<br>Insert<br>Wendeschneidplatte | Yedek Parçaları / Spare Parts / Ersatzteile |  |                              |  |                        |                        |  |  |           |              |             |             |        |        |               |          |
|--|------------------------|---|---|----|-----|----|---|---|--|------------------------------|--|------------------------|------------------------|--|--|-----------|--------------|-------------|-------------|--------|--------|---------------|----------|
|  | R                      | L | HF=H  | B  | LF  | WF |   | Baskı Pabuçu<br>Wedge Clamp<br>Spannpratze  | Pabuç Vidası<br>Clamp Screw<br>Klemmschraube | Altılık<br>Shim<br>Unterlage | Altılık Vidası<br>Shim Screw<br>Schraube für Unterlage | Yay<br>Spring<br>Feder | Oring<br>Ring<br>Feder | Sızdırmaz Vida<br>Threaded Pin<br>Резьбовой Винт | Anahtar<br>Allen Key<br>Innenschlüssel |           |              |             |             |        |        |               |          |
| TDJNR/L 2020 K15-H                                 | ●                      | ● | 20  | 20 | 125 | 25 | DNM. 1506..                               |   |  |                              |  |                        |                        |  |  |           |              |             |             |        |        |               |          |
| 2525 M15-H   | ●                      | ● | 25  | 25 | 150 | 32 |   |   |  |                              |  |                        |                        |  |  | ATKH-01-R | AKV-33-M6x22 | AADN-3-0001 | AAV-13-M5x8 | AKY-01 | AXR-01 | 2705-G1/8x5.5 | AAL-03-3 |
| 3232 P15-H   | ●                      | ● | 32  | 32 | 170 | 40 |   |   |  |                              |  |                        |                        |  |  | ATKH-02-L |              |             |             |        |        |               |          |

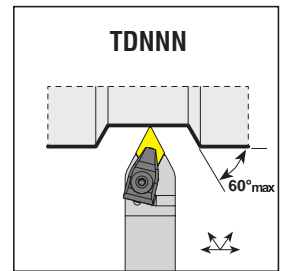
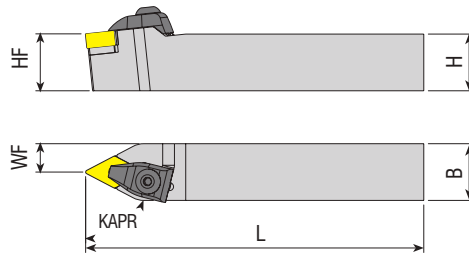

| Takım Kodu<br>Ordering Code<br>Bestell-Bezeichnung | Stok<br>Stock<br>Lager | Takım Ölçüleri (mm)<br>Dimension (mm)<br>Abmessung (mm) |    |     |      | Kesici Uç<br>Insert<br>Wendeschneidplatte | Yedek Parçaları / Spare Parts / Ersatzteile |  |                              |  |                         |                      |  |        |              |             |              |       |         |          |
|--|------------------------|---|----|-----|------|---|---|--|------------------------------|--|-------------------------|----------------------|--|--------|--------------|-------------|--------------|-------|---------|----------|
|  |                        | HF=H  | B  | LF  | WF   |   | Baskı Pabuçu<br>Wedge Clamp<br>Spannpratze  | Pabuç Vidası<br>Clamp Screw<br>Klemmschraube | Altılık<br>Shim<br>Unterlage | Altılık Vidası<br>Shim Screw<br>Schraube für Unterlage | Segman<br>Ring<br>Feder | Pul<br>Stamp<br>Ring | Anahtar<br>Allen Key<br>Innenschlüssel |        |              |             |              |       |         |          |
| TDNNN 1616 H11                                     | ●                      | 16  | 16 | 100 | 8    | DNM. 1104..                               |   |  |                              |  |                         |                      |  |        |              |             |              |       |         |          |
| 2020 K11   | ●                      | 20  | 20 | 125 | 10   |   |   |  |                              |  |                         |                      |  | ATK-01 | AKV-01-M5x22 | AADN-2-0001 | AAV-04-M5x12 | -     | ABPL-01 | AAL-03-3 |
| 2525 M11   | ●                      | 25  | 25 | 150 | 12.5 |   |   |  |                              |  |                         |                      |  |        |              |             |              |       |         |          |
| 2020 K15   | ●                      | 20  | 20 | 125 | 10   | DNM. 1506..                               |   |  |                              |  |                         |                      |  |        |              |             |              |       |         |          |
| 2525 M15   | ●                      | 25  | 25 | 150 | 12.5 |   |   |  |                              |  |                         |                      |  | ATK-02 | AKV-30-M6x22 | AADN-3-0001 | AAV-02-M5x12 | AS-01 |         |          |
| 3232 P15   | ●                      | 32  | 32 | 170 | 16   |   |   |  |                              |  |                         |                      |  |        |              |             |              |       |         |          |
| 4040 S15   | ○                      | 40  | 40 | 250 | 20   |   |   |  |                              |  |                         |                      |  |        |              |             |              |       |         |          |
| 5050 S15   | ○                      | 50  | 50 | 250 | 25   |   |   |  |                              |  |                         |                      |  |        |              |             |              |       |         |          |

R: Sağ / Right / Rechts L: Sol / Left / Links  
● Stokta / In Stock / Auf Lager ○ Stokta Yok / Non Stock Item / Kein Lagerartikel, Lieferzeit auf Anfrage

Sipariş Örneği/Ordering Example/Bestellbeispiel  
1 ad./pcs./stück TDJNR 2020 K15-H

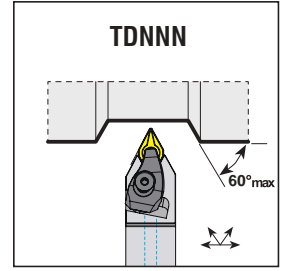
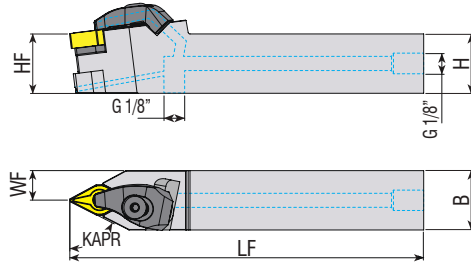
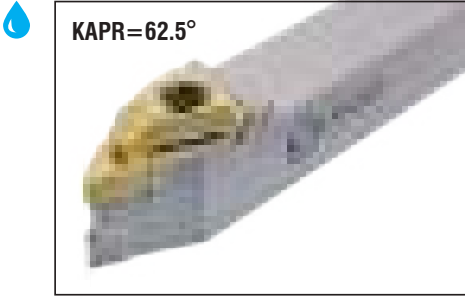

| Takım Kodu<br>Ordering Code<br>Bestell-Bezeichnung | Stok<br>Stock<br>Lager | Takım Ölçüleri (mm)<br>Dimension (mm)<br>Abmessung (mm) |    |     |    | Kesici Uç<br>Insert<br>Wendeschneidplatte | Yedek Parçaları / Spare Parts / Ersatzteile |  |                             |   |                        |                        |  |   |
|--|------------------------|---|----|-----|----|---|---|--|-----------------------------|---|------------------------|------------------------|--|---|
|  |                        | HF=H  | B  | LF  | WF |   | Baskı Pabucu<br>Wedge Clamp<br>Spannpratze  | Pabuç Vidası<br>Clamp Screw<br>Klemmschraube | Altlık<br>Shim<br>Unterlage | Altlık Vidası<br>Shim Screw<br>Schraube für Unterlage | Yay<br>Spring<br>Feder | Oring<br>Ring<br>Feder | Sızdırmaz Vidası<br>Threaded Pin<br>Резьбовой Винт | Anahtar<br>Allen Key<br>Innensechskantschlüssel |
| <b>TDNNN 2525 M15-H</b>                            | ●                      | 25  | 25 | 150 | 32 |   |   |  |                             |   |                        |                        |  |   |
|  |                        |   |    |     |    | <b>DNM. 1506..</b>                        | ATKH-01-R<br>ATKH-02-L                      | AKV-33-M6x22                                 | AADN-3-0001                 | AAV-13-M5x8   | AKY-01                 | AXR-01                 | 2705-G1/8x5.5                                      | AAL-03-3  |

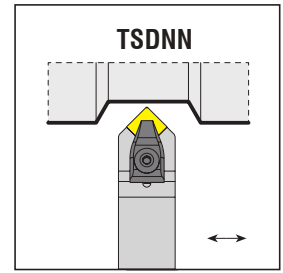
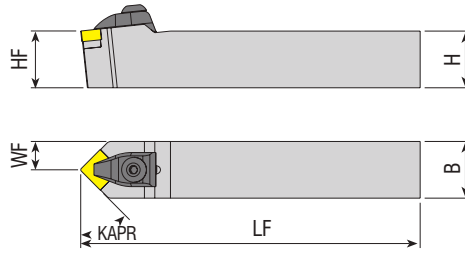

| Takım Kodu<br>Ordering Code<br>Bestell-Bezeichnung | Stok<br>Stock<br>Lager | Takım Ölçüleri (mm)<br>Dimension (mm)<br>Abmessung (mm) |    |     |      | Kesici Uç<br>Insert<br>Wendeschneidplatte | Yedek Parçaları / Spare Parts / Ersatzteile |  |                             |   |                         |                      |   |  |
|--|------------------------|---|----|-----|------|---|---|--|-----------------------------|---|-------------------------|----------------------|---|--|
|  |                        | HF=H  | B  | LF  | WF   |   | Baskı Pabucu<br>Wedge Clamp<br>Spannpratze  | Pabuç Vidası<br>Clamp Screw<br>Klemmschraube | Altlık<br>Shim<br>Unterlage | Altlık Vidası<br>Shim Screw<br>Schraube für Unterlage | Segman<br>Ring<br>Feder | Pul<br>Stamp<br>Ring | Anahtar<br>Allen Key<br>Innensechskantschlüssel |  |
| <b>TSDNN 1616 H12</b>                              | ●                      | 16  | 16 | 100 | 8    |   |   |  |                             |   |                         |                      |   |  |
| <b>2020 K12</b>                                    | ●                      | 20  | 20 | 125 | 10   | <b>SNM. 1204..</b>                        | ATK-02                                      | AKV-30-M6x22                                 | AASN-3-0004                 | AAV-02-M5x12  | AS-01                   | ABPL-01              | AAL-03-3  |  |
| <b>2525 M12</b>                                    | ●                      | 25  | 25 | 150 | 12.5 |   |   |  |                             |   |                         |                      |   |  |
| <b>3232 P12</b>                                    | ●                      | 32  | 32 | 170 | 16   |   |   |  |                             |   |                         |                      |   |  |
| <b>2525 M15</b>                                    | ○                      | 25  | 25 | 150 | 12.5 | <b>SNM. 1506..</b>                        | ATK-04                                      | AKV-19-M7x25                                 | AASN-3-0023                 | AAV-05-M6x15  | AS-02                   | ABPL-02              | AAL-05-4  |  |
| <b>3232 P15</b>                                    | ●                      | 32  | 32 | 170 | 16   |   |   |  |                             |   |                         |                      |   |  |
| <b>4040 S15</b>                                    | ○                      | 40  | 40 | 250 | 20   |   |   |  |                             |   |                         |                      |   |  |

R: Sağ / Right / Rechts L: Sol / Left / Links

● Stokta / In Stock / Auf Lager ○ Stokta Yok / Non Stock Item / Kein Lagerartikel, Lieferzeit auf Anfrage

Sipariş Örneği/Ordering Example/Bestellbeispiel  
1 ad./pcs./stück TDNNN 2525 M15-H

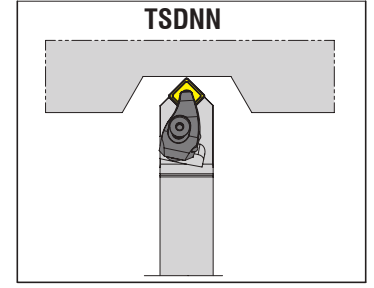
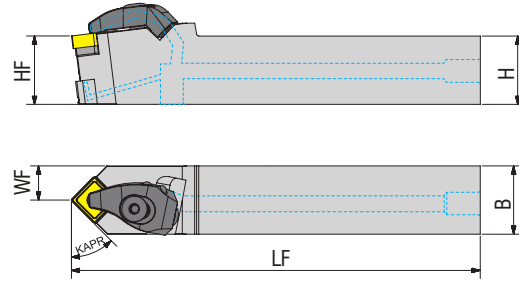

| Takım Kodu<br>Ordering Code<br>Bestell-Bezeichnung | Stok<br>Stock<br>Lager |   | Takım Ölçüleri (mm)<br>Dimension (mm)<br>Abmessung (mm) |    |     |      | Kesici Uç<br>Insert<br>Wendeschneidplatte | Yedek Parçaları / Spare Parts / Ersatzteile |  |                             |   |                        |                        |  |   |  |  |
|--|------------------------|---|---|----|-----|------|---|---|--|-----------------------------|---|------------------------|------------------------|--|---|--|--|
|  | R                      | L | HF=H  | B  | LF  | WF   |   | Baskı Pabuçu<br>Wedge Clamp<br>Spannpratze  | Pabuç Vidası<br>Clamp Screw<br>Klemmschraube | Altlık<br>Shim<br>Unterlage | Altlık Vidası<br>Shim Screw<br>Schraube für Unterlage | Yay<br>Spring<br>Feder | Oring<br>Ring<br>Feder | Sızdırmaz Vida<br>Threaded Pin<br>Резьбовой Винт | Anahtar<br>Allen Key<br>Innensechskantschlüssel |  |  |
| <b>TSDNN 2525 M12-H</b>                            | ○                      | ○ | 25  | 25 | 150 | 25   | SNM. 1204..                               | ATKH-01-R<br>ATKH-02-L                      | AKV-33-M6x22                                 | AASN-3-0004                 | AAV-02-M5x12  |                        |                        | 2705-G1/8x5.5                                    | AAL-03-3  |  |  |
| <b>3232 P12-H</b>                                  | ○                      | ○ | 32  | 32 | 170 | 16   |   |   |  |                             |   |                        |                        |  |   |  |  |
| <b>2525 M15-H</b>                                  | ○                      | ○ | 25  | 25 | 150 | 12.7 | SNM. 1506..                               | ATKH-07-R<br>ATKH-08-L                      | AKV-39-M7x21                                 | AASN-3-0023                 | AAV-05-M6x10  | AKY-01                 | AXR-01                 | 2705-G1/8x5.5                                    | AAL-05-4  |  |  |
| <b>3232 P15-H</b>                                  | ○                      | ○ | 32  | 32 | 170 | 16   |   |   |  |                             |   |                        |                        |  |   |  |  |
| <b>4040 S15-H</b>                                  | ○                      | ○ | 40  | 40 | 250 | 20   |   |   |  |                             |   |                        |                        |  |   |  |  |

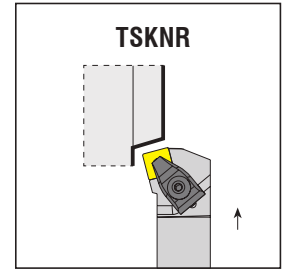
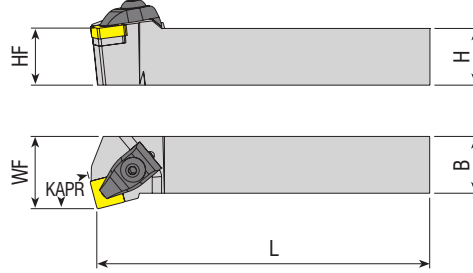

| Takım Kodu<br>Ordering Code<br>Bestell-Bezeichnung | Stok<br>Stock<br>Lager |   | Takım Ölçüleri (mm)<br>Dimension (mm)<br>Abmessung (mm) |    |     |    | Kesici Uç<br>Insert<br>Wendeschneidplatte | Yedek Parçaları / Spare Parts / Ersatzteile |  |                             |   |                         |                      |   |
|--|------------------------|---|---|----|-----|----|---|---|--|-----------------------------|---|-------------------------|----------------------|---|
|  | R                      | L | HF=H  | B  | LF  | WF |   | Baskı Pabuçu<br>Wedge Clamp<br>Spannpratze  | Pabuç Vidası<br>Clamp Screw<br>Klemmschraube | Altlık<br>Shim<br>Unterlage | Altlık Vidası<br>Shim Screw<br>Schraube für Unterlage | Segman<br>Ring<br>Feder | Pul<br>Stamp<br>Ring | Anahtar<br>Allen Key<br>Innensechskantschlüssel |
| <b>TSKNR/L 2020 K12</b>                            | ●                      | ● | 20  | 20 | 125 | 25 | SNM. 1204..                               | ATK-02                                      | AKV-30-M6x22                                 | AASN-3-0004                 | AAV-02-M5x12  | AS-01                   | ABPL-01              | AAL-03-3  |
| <b>2525 M12</b>                                    | ●                      | ● | 25  | 25 | 150 | 32 |   |   |  |                             |   |                         |                      |   |
| <b>3232 P12</b>                                    | ●                      | ● | 32  | 32 | 170 | 40 |   |   |  |                             |   |                         |                      |   |
| <b>3232 P15</b>                                    | ●                      | ● | 32  | 32 | 170 | 40 | SNM. 1506..                               | ATK-04                                      | AKV-19-M7x25                                 | AASN-3-0023                 | AAV-05-M6x15  | AS-02                   | ABPL-02              | AAL-05-4  |

R: Sağ / Right / Rechts L: Sol / Left / Links

● Stokta / In Stock / Auf Lager ○ Stokta Yok / Non Stock Item / Kein Lagerartikel, Lieferzeit auf Anfrage

Sipariş Örneği/Ordering Example/Bestellbeispiel

1 ad./pcs./stück TSDNN 2525 M12-H

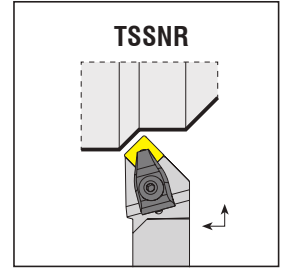
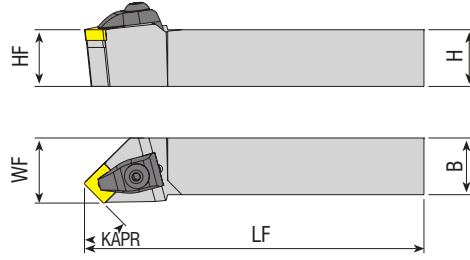

| Takım Kodu<br>Ordering Code<br>Bestell-Bezeichnung | Stok<br>Stock<br>Lager |   | Takım Ölçüleri (mm)<br>Dimension (mm)<br>Abmessung (mm) |    |     |    | Kesici Uç<br>Insert<br>Wendeschneidplatte | Yedek Parçaları / Spare Parts / Ersatzteile |  |                             |   |                         |                      |   |  |
|--|------------------------|---|---|----|-----|----|---|---|--|-----------------------------|---|-------------------------|----------------------|---|--|
|  | R                      | L | HF=H  | B  | LF  | WF |   | Baskı Pabuçu<br>Wedge Clamp<br>Spannpratze  | Pabuç Vidası<br>Clamp Screw<br>Klemmschraube | Altlık<br>Shim<br>Unterlage | Altlık Vidası<br>Shim Screw<br>Schraube für Unterlage | Segman<br>Ring<br>Feder | Pul<br>Stamp<br>Ring | Anahtar<br>Allen Key<br>Innensechskantschlüssel |  |
| <b>TSSNR/L 2020 K12</b>                            | ●                      | ● | 20  | 20 | 125 | 25 |   |   |  |                             |   |                         |                      |   |  |
| <b>2525 M12</b>                                    | ●                      | ● | 25  | 25 | 150 | 32 | <b>SNM. 1204..</b>                        | ATK-02                                      | AKV-30-M6x22                                 | AASN-3-0004                 | AAV-02-M5x12  | AS-01                   | ABPL-01              | AAL-03-3  |  |
| <b>3232 P12</b>                                    | ●                      | ● | 32  | 32 | 170 | 40 |   |   |  |                             |   |                         |                      |   |  |
| <b>2525 M15</b>                                    | ●                      | ● | 25  | 25 | 150 | 32 | <b>SNM. 1506..</b>                        | ATK-04                                      | AKV-19-M7x25                                 | AASN-3-0023                 | AAV-05-M6x15  | AS-02                   | ABPL-02              | AAL-05-4  |  |
| <b>3232 P15</b>                                    | ●                      | ● | 32  | 32 | 170 | 40 |   |   |  |                             |   |                         |                      |   |  |

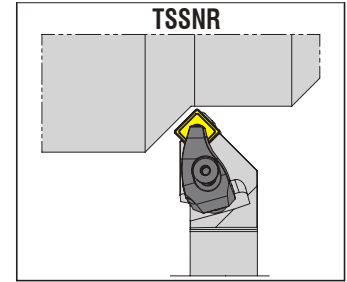
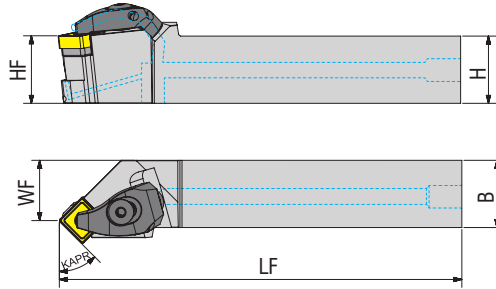

| Takım Kodu<br>Ordering Code<br>Bestell-Bezeichnung | Stok<br>Stock<br>Lager |   | Takım Ölçüleri (mm)<br>Dimension (mm)<br>Abmessung (mm) |    |     |    | Kesici Uç<br>Insert<br>Wendeschneidplatte | Yedek Parçaları / Spare Parts / Ersatzteile |  |                             |   |                        |                        |  |   |
|--|------------------------|---|---|----|-----|----|---|---|--|-----------------------------|---|------------------------|------------------------|--|---|
|  | R                      | L | HF=H  | B  | LF  | WF |   | Baskı Pabuçu<br>Wedge Clamp<br>Spannpratze  | Pabuç Vidası<br>Clamp Screw<br>Klemmschraube | Altlık<br>Shim<br>Unterlage | Altlık Vidası<br>Shim Screw<br>Schraube für Unterlage | Yay<br>Spring<br>Feder | Oring<br>Ring<br>Feder | Sızdırmaz Vida<br>Threaded Pin<br>Резьбовой Винт | Anahtar<br>Allen Key<br>Innensechskantschlüssel |
| <b>TSSNR/L 2525 M12-H</b>                          | ○                      | ○ | 25  | 25 | 150 | 32 | <b>SNM. 1204..</b>                        | ATKH-01-R                                   | AKV-33-M6x22                                 | AASN-3-0004                 | AAV-02-M5x12  |                        |                        |  |   |
| <b>3232 P12-H</b>                                  | ○                      | ○ | 32  | 32 | 170 | 32 | ATKH-02-L                                 |   |  |                             |   |                        |                        |  |   |
| <b>2525 M15-H</b>                                  | ○                      | ○ | 25  | 25 | 150 | 40 | <b>SNM. 1506..</b>                        | ATKH-07-R                                   | AKV-39-M7x21                                 | AASN-3-0023                 | AAV-05-M6x10  | AKY-01                 | AXR-01                 | 2705-G1/8x5.5                                    |   |
| <b>3232 P15-H</b>                                  | ○                      | ○ | 32  | 32 | 170 | 40 | ATKH-08-L                                 |   |  |                             |   |                        |                        |  |   |
| <b>4040 S15-H</b>                                  | ○                      | ○ | 40  | 40 | 250 | 50 |   |   |  |                             |   |                        |                        |  |   |

R: Sağ / Right / Rechts L: Sol / Left / Links  
● Stokta / In Stock / Auf Lager ○ Stokta Yok / Non Stock Item / Kein Lagerartikel, Lieferzeit auf Anfrage

Sipariş Örneği/Ordering Example/Bestellbeispiel  
1 ad./pcs./stück TSSNR 2020 K12

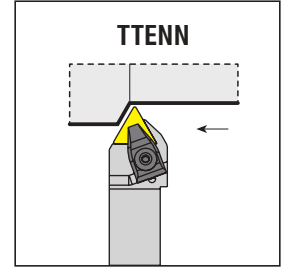
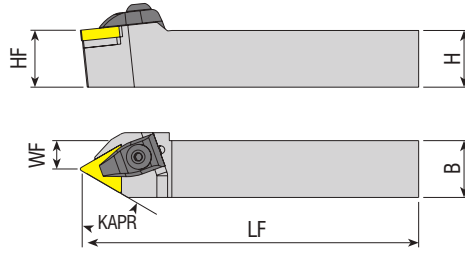

| Takım Kodu<br>Ordering Code<br>Bestell-Bezeichnung | Stok<br>Stock<br>Lager |   | Takım Ölçüleri (mm)<br>Dimension (mm)<br>Abmessung (mm) |    |     |      | Kesici Uç<br>Insert<br>Wendeschneidplatte | Yedek Parçaları / Spare Parts / Ersatzteile |  |                             |   |                         |                      |   |
|--|------------------------|---|---|----|-----|------|---|---|--|-----------------------------|---|-------------------------|----------------------|---|
|  | R                      | L | HF=H  | B  | LF  | WF   |   | Baskı Pabucu<br>Wedge Clamp<br>Spannpratze  | Pabuç Vidası<br>Clamp Screw<br>Klemmschraube | Altlık<br>Shim<br>Unterlage | Altlık Vidası<br>Shim Screw<br>Schraube für Unterlage | Segman<br>Ring<br>Feder | Pul<br>Stamp<br>Ring | Anahtar<br>Allen Key<br>Innensechskantschlüssel |
| <b>TTENN 2020 K16</b>                              | ●                      |   | 20  | 20 | 125 | 10   | TNM. 1604..                               |   |  |                             |   |                         |                      |   |
| <b>2525 M16</b>                                    | ●                      |   | 25  | 25 | 150 | 12.5 |   |   |  |                             |   |                         |                      |   |
| <b>3232 P16</b>                                    | ●                      |   | 32  | 32 | 170 | 16   |   |   |  |                             |   |                         |                      |   |
| <b>2525 M22</b>                                    | ●                      |   | 25  | 25 | 150 | 12.5 | TNM. 2204..                               |   |  |                             |   |                         |                      |   |
| <b>3232 P22</b>                                    | ●                      |   | 32  | 32 | 170 | 16   |   |   |  |                             |   |                         |                      |   |
| <b>4040 S22</b>                                    | ○                      |   | 40  | 40 | 250 | 20   |   |   |  |                             |   |                         |                      |   |

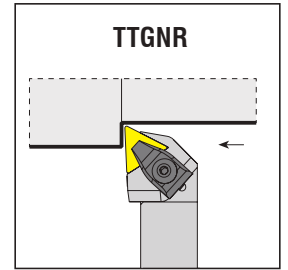
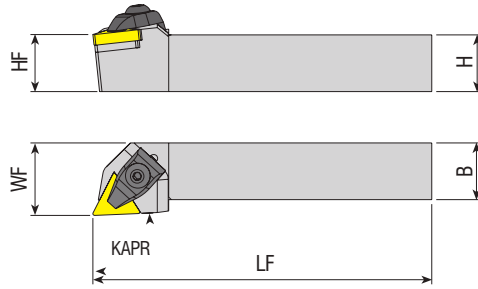

| Takım Kodu<br>Ordering Code<br>Bestell-Bezeichnung | Stok<br>Stock<br>Lager |   | Takım Ölçüleri (mm)<br>Dimension (mm)<br>Abmessung (mm) |    |     |    | Kesici Uç<br>Insert<br>Wendeschneidplatte | Yedek Parçaları / Spare Parts / Ersatzteile |  |                             |   |                         |                      |   |
|--|------------------------|---|---|----|-----|----|---|---|--|-----------------------------|---|-------------------------|----------------------|---|
|  | R                      | L | HF=H  | B  | LF  | WF |   | Baskı Pabucu<br>Wedge Clamp<br>Spannpratze  | Pabuç Vidası<br>Clamp Screw<br>Klemmschraube | Altlık<br>Shim<br>Unterlage | Altlık Vidası<br>Shim Screw<br>Schraube für Unterlage | Segman<br>Ring<br>Feder | Pul<br>Stamp<br>Ring | Anahtar<br>Allen Key<br>Innensechskantschlüssel |
| <b>TTGNR/L 2020 K16</b>                            | ●                      | ● | 20  | 20 | 125 | 25 | TNM. 1604..                               |   |  |                             |   |                         |                      |   |
| <b>2525 M16</b>                                    | ●                      | ● | 25  | 25 | 150 | 32 |   |   |  |                             |   |                         |                      |   |
| <b>3232 P16</b>                                    | ●                      | ● | 32  | 32 | 170 | 40 |   |   |  |                             |   |                         |                      |   |
| <b>2525 M22</b>                                    | ●                      | ● | 25  | 25 | 150 | 32 | TNM. 2204..                               |   |  |                             |   |                         |                      |   |
| <b>3232 P22</b>                                    | ●                      | ● | 32  | 32 | 170 | 40 |   |   |  |                             |   |                         |                      |   |
| <b>4040 S22</b>                                    | ●                      | ○ | 40  | 40 | 250 | 50 |   |   |  |                             |   |                         |                      |   |

R: Sağ / Right / Rechts L: Sol / Left / Links

● Stokta / In Stock / Auf Lager ○ Stokta Yok / Non Stock Item / Kein Lagerartikel, Lieferzeit auf Anfrage

Sipariş Örneği/Ordering Example/Bestellbeispiel

1 ad./pcs./stück TTENN 2020 K16

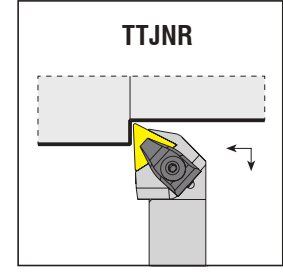
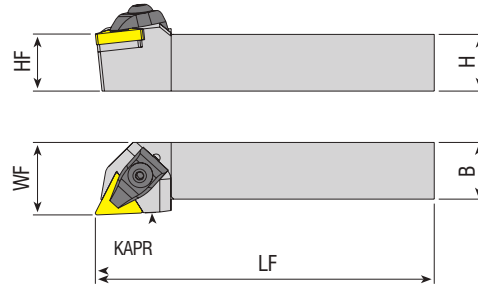

| Takım Kodu<br>Ordering Code<br>Bestell-Bezeichnung | Stok<br>Stock<br>Lager |   | Takım Ölçüleri (mm)<br>Dimension (mm)<br>Abmessung (mm) |    |     |    | Kesici Uç<br>Insert<br>Wendeschneidplatte | Yedek Parçaları / Spare Parts / Ersatzteile |  |                             |   |                         |                      |   |  |
|--|------------------------|---|---|----|-----|----|---|---|--|-----------------------------|---|-------------------------|----------------------|---|--|
|  | R                      | L | HF=H  | B  | LF  | WF |   | Baskı Pabucu<br>Wedge Clamp<br>Spannpratze  | Pabuç Vidası<br>Clamp Screw<br>Klemmschraube | Altlık<br>Shim<br>Unterlage | Altlık Vidası<br>Shim Screw<br>Schraube für Unterlage | Segman<br>Ring<br>Feder | Pul<br>Stamp<br>Ring | Anahtar<br>Allen Key<br>Innensechskantschlüssel |  |
| TTJNR/L 2020 K16                                   | ●                      | ● | 20  | 20 | 125 | 25 | TNM. 1604..                               |   | AKV-01-M5x22                                 | AATN-2-0002                 | AAV-03-M5x12  | -                       | ABPL-01              | AAL-03-3  |  |
| 2525 M16   | ●                      | ● | 25  | 25 | 150 | 32 |   |   |  |                             |   |                         |                      |   |  |
| 3232 P16   | ●                      | ● | 32  | 32 | 170 | 40 |   |   |  |                             |   |                         |                      |   |  |
| 2525 M22   | ●                      | ● | 25  | 25 | 150 | 32 | TNM. 2204..                               | ATK-02                                      | AKV-30-M6x22                                 | AATN-3-0015                 | AAV-02-M5x12  | AS-01                   | ABPL-01              | AAL-03-3  |  |
| 3232 P22   | ●                      | ● | 32  | 32 | 170 | 40 |   |   |  |                             |   |                         |                      |   |  |
| 4040 S22   | ○                      | ○ | 40  | 40 | 250 | 50 |   |   |  |                             |   |                         |                      |   |  |

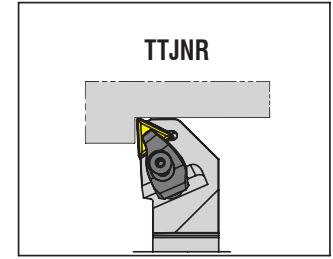
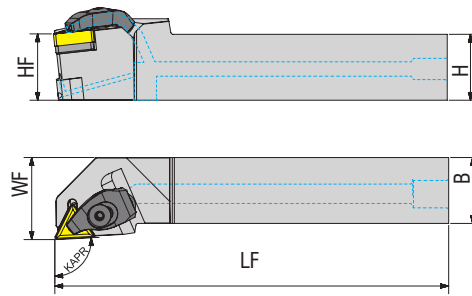

| Takım Kodu<br>Ordering Code<br>Bestell-Bezeichnung | Stok<br>Stock<br>Lager |   | Takım Ölçüleri (mm)<br>Dimension (mm)<br>Abmessung (mm) |    |     |    | Kesici Uç<br>Insert<br>Wendeschneidplatte | Yedek Parçaları / Spare Parts / Ersatzteile |  |                             |   |                        |                        |   |   |
|--|------------------------|---|---|----|-----|----|---|---|--|-----------------------------|---|------------------------|------------------------|---|---|
|  | R                      | L | HF=H  | B  | LF  | WF |   | Baskı Pabucu<br>Wedge Clamp<br>Spannpratze  | Pabuç Vidası<br>Clamp Screw<br>Klemmschraube | Altlık<br>Shim<br>Unterlage | Altlık Vidası<br>Shim Screw<br>Schraube für Unterlage | Yay<br>Spring<br>Feder | Oring<br>Ring<br>Feder | Sızdırmaz Vidası<br>Threaded Pin<br>Резьбовой Вит | Anahtar<br>Allen Key<br>Innensechskantschlüssel |
| TTJNR/L 2525 M16-H                                 | ○                      | ○ | 25  | 25 | 150 | 32 | TNM. 1604..                               | ATKH-03-R<br>ATKH-04-L                      | AKV-37-M5x18                                 | AATN-2-000                  | AAV-03-M5x12  | AKY-02                 | AXR-02                 | 2705-G1/8x5.5                                     | AAL-02-2.5                                      |
| 3232 P16-H   | ○                      | ○ | 32  | 32 | 170 | 32 |   |   |  |                             |   |                        |                        |   |   |
| 2525 M22-H   | ○                      | ○ | 25  | 25 | 150 | 40 | TNM. 2204..                               | ATKH-01-R<br>ATKH-02-L                      | AKV-33-M6x22                                 | AATN-3-0015                 | AAV-02-M5x12  | AKY-01                 | AXR-01                 | AAL-03-3  |   |
| 3232 P22-H   | ○                      | ○ | 32  | 32 | 170 | 40 |   |   |  |                             |   |                        |                        |   |   |

R: Sağ / Right / Rechts L: Sol / Left / Links  
● Stokta / In Stock / Auf Lager ○ Stokta Yok / Non Stock Item / Kein Lagerartikel, Lieferzeit auf Anfrage

Sipariş Örneği/Ordering Example/Bestellbeispiel  
1 ad./pcs./stück TTJNR 2020 K16

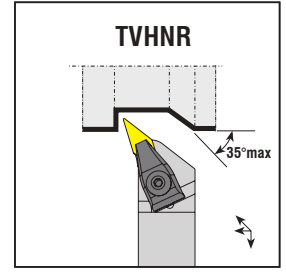
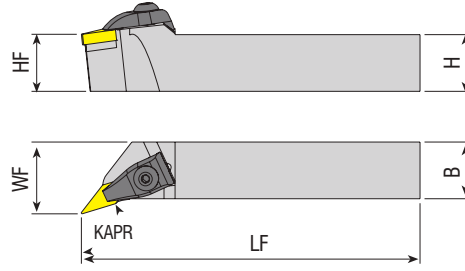

| Takım Kodu<br>Ordering Code<br>Bestell-Bezeichnung | Stok<br>Stock<br>Lager |   | Takım Ölçüleri (mm)<br>Dimension (mm)<br>Abmessung (mm) |    |     |    | Kesici Uç<br>Insert<br>Wendeschneidplatte | Yedek Parçaları / Spare Parts / Ersatzteile |  |                             |   |                         |                      |   |
|--|------------------------|---|---|----|-----|----|---|---|--|-----------------------------|---|-------------------------|----------------------|---|
|  | R                      | L | HF=H  | B  | LF  | WF |   | Baskı Pabuçu<br>Wedge Clamp<br>Spannpratze  | Pabuç Vidası<br>Clamp Screw<br>Klemmschraube | Altlık<br>Shim<br>Unterlage | Altlık Vidası<br>Shim Screw<br>Schraube für Unterlage | Segman<br>Ring<br>Feder | Pul<br>Stamp<br>Ring | Anahtar<br>Allen Key<br>Innensechskantschlüssel |
| TVHNR/L 2020 K16                                   | ●                      | ● | 20  | 20 | 125 | 25 | VNM. 1604..                               |   |  |                             |   |                         |                      |   |
| 2525 M16   | ●                      | ● | 25  | 25 | 150 | 32 |   |   |  |                             |   |                         |                      |   |
| 3232 P16   | ●                      | ● | 32  | 32 | 170 | 40 |   |   |  |                             |   |                         |                      |   |

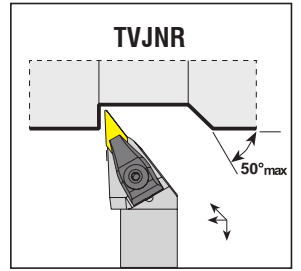
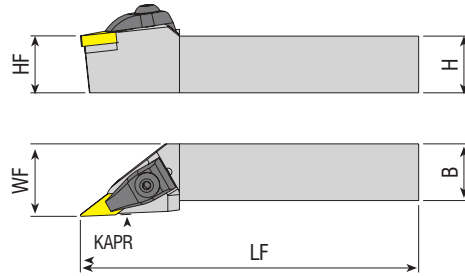

| Takım Kodu<br>Ordering Code<br>Bestell-Bezeichnung | Stok<br>Stock<br>Lager |   | Takım Ölçüleri (mm)<br>Dimension (mm)<br>Abmessung (mm) |    |     |    | Kesici Uç<br>Insert<br>Wendeschneidplatte | Yedek Parçaları / Spare Parts / Ersatzteile |  |                             |   |                         |                      |   |
|--|------------------------|---|---|----|-----|----|---|---|--|-----------------------------|---|-------------------------|----------------------|---|
|  | R                      | L | HF=H  | B  | LF  | WF |   | Baskı Pabuçu<br>Wedge Clamp<br>Spannpratze  | Pabuç Vidası<br>Clamp Screw<br>Klemmschraube | Altlık<br>Shim<br>Unterlage | Altlık Vidası<br>Shim Screw<br>Schraube für Unterlage | Segman<br>Ring<br>Feder | Pul<br>Stamp<br>Ring | Anahtar<br>Allen Key<br>Innensechskantschlüssel |
| TVJNR/L 2020 K16                                   | ●                      | ● | 20  | 20 | 125 | 25 | VNM. 1604..                               |   |  |                             |   |                         |                      |   |
| 2525 M16   | ●                      | ● | 25  | 25 | 150 | 32 |   |   |  |                             |   |                         |                      |   |
| 3232 P16   | ●                      | ● | 32  | 32 | 170 | 40 |   |   |  |                             |   |                         |                      |   |

R: Sağ / Right / Rechts L: Sol / Left / Links

● Stokta / In Stock / Auf Lager ○ Stokta Yok / Non Stock Item / Kein Lagerartikel, Lieferzeit auf Anfrage

Sipariş Örneği/Ordering Example/Bestellbeispiel

1 ad./pcs./stück TVHNR 2020 K16





KAPR=93°

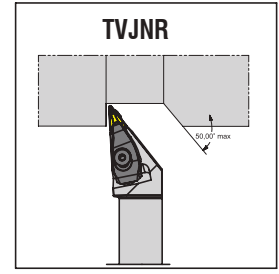
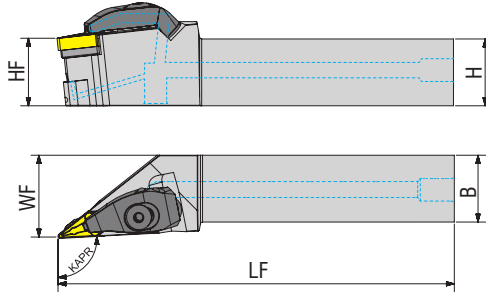
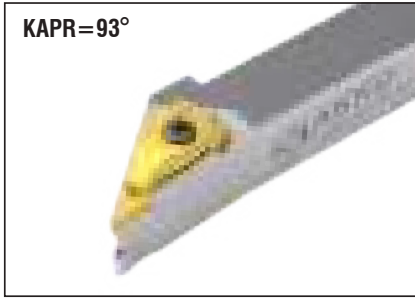

Takım Kodu  
Ordering Code  
Bestell-Bezeichnung

Stok  
Stock  
Lager

Takım Ölçüleri (mm)  
Dimension (mm)  
Abmessung (mm)

Kesici Uç  
Insert  
Wendeschneidplatte

Baskı Pabuçu  
Wedge Clamp  
Spannpratze

Pabuç Vidası  
Clamp Screw  
Klemmschraube

Altlık  
Shim  
Unterlage

Altlık Vidası  
Shim Screw  
Schraube für Unterlage

Yay  
Spring  
Feder

Oring  
Ring  
Feder

Sızdırmaz Vidı  
Threaded Pin  
Резьбовой Винт

Anahtar  
Allen Key  
Innensechskantschlüssel

| R | L | HF=H | B | LF | WF |
|---|---|------|---|----|----|
|---|---|------|---|----|----|

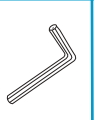
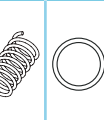
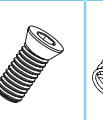
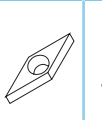
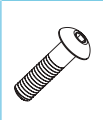
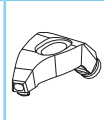

TVJNR/L 2020 K16-H  
2525 M16-H  
3232 P16-H

|   |   |    |    |     |    |
|---|---|----|----|-----|----|
| ○ | ○ | 20 | 20 | 125 | 25 |
| ○ | ○ | 25 | 25 | 150 | 32 |
| ○ | ○ | 32 | 32 | 170 | 40 |

VNM. 1604..

ATKH-05-R  
ATKH-06-L

AKV-33-M6x22

AAVN-2-0002

AAV-04-M5x12

AKY-01

AXR-01

2705-G1/8x5.5  
AAL-03-3

Yedek Parçaları / Spare Parts / Ersatzteile

KAPR=72.5°

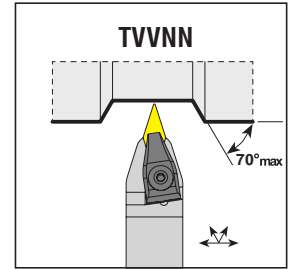
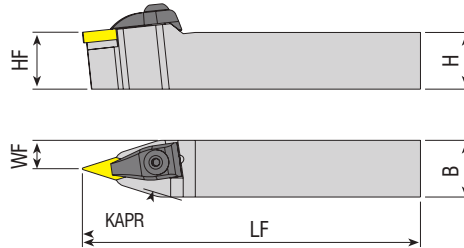

Takım Kodu  
Ordering Code  
Bestell-Bezeichnung

Stok  
Stock  
Lager

Takım Ölçüleri (mm)  
Dimension (mm)  
Abmessung (mm)

Kesici Uç  
Insert  
Wendeschneidplatte

Baskı Pabuçu  
Wedge Clamp  
Spannpratze

Pabuç Vidası  
Clamp Screw  
Klemmschraube

Altlık  
Shim  
Unterlage

Altlık Vidası  
Shim Screw  
Schraube für Unterlage

Segman  
Ring  
Feder

Pul  
Stamp  
Ring

Anahtar  
Allen Key  
Innensechskantschlüssel

| HF=H | B | LF | WF |
|------|---|----|----|
|------|---|----|----|

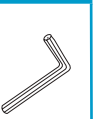
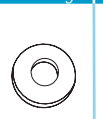
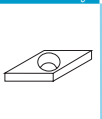
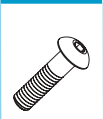
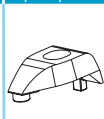

TVVNN 2020 K16  
2525 M16  
3232 P16

|   |    |    |     |      |
|---|----|----|-----|------|
| ● | 20 | 20 | 125 | 10   |
| ● | 25 | 25 | 150 | 12.5 |
| ● | 32 | 32 | 170 | 16   |

VNM. 1604..

ATK-03

AKV-30-M6x22

AAVN-2-0002

AAV-04-M5x12

AS-01

ABPL-01

AAL-03-3

Yedek Parçaları / Spare Parts / Ersatzteile

R: Sağ / Right / Rechts L: Sol / Left / Links

● Stokta / In Stock / Auf Lager ○ Stokta Yok / Non Stock Item / Kein Lagerartikel, Lieferzeit auf Anfrage

Sipariş Örneği/Ordering Example/Bestellbeispiel

1 ad./pcs./stück TVJNR 2020 H16-H

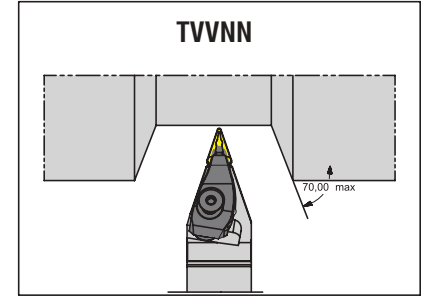
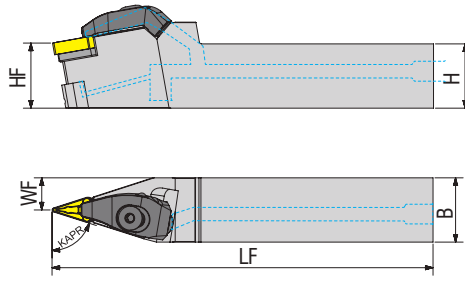
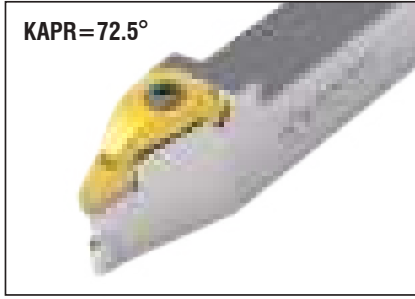

| Takım Kodu<br>Ordering Code<br>Bestell-Bezeichnung | Stok<br>Stock<br>Lager |   | Takım Ölçüleri (mm)<br>Dimension (mm)<br>Abmessung (mm) |    |     |      | Kesici Uç<br>Insert<br>Wendeschneidplatte | Yedek Parçaları / Spare Parts / Ersatzteile |  |                             |   |                        |                        |  |   |  |
|--|------------------------|---|---|----|-----|------|---|---|--|-----------------------------|---|------------------------|------------------------|--|---|--|
|  | R                      | L | HF=H  | B  | LF  | WF   |   | Baskı Pabuçu<br>Wedge Clamp<br>Spannpratze  | Pabuç Vidası<br>Clamp Screw<br>Klemmschraube | Altlık<br>Shim<br>Unterlage | Altlık Vidası<br>Shim Screw<br>Schraube für Unterlage | Yay<br>Spring<br>Feder | Oring<br>Ring<br>Feder | Sızdırmaz Vida<br>Threaded Pin<br>Резьбовой Винт | Anahtar<br>Allen Key<br>Innensechskantschlüssel |  |
| <b>TVVNN 2020 K16-H</b>                            | ○                      | ○ | 20  | 20 | 125 | 10   | <b>VNM. 1604..</b>                        | ATKH-05-R<br>ATKH-06-L                      | AKV-33-M6x22                                 | AAVN-2-0002                 | AAV-04-M5x12  | AKY-01                 | AXR-01                 | 2705-G1/8x5.5                                    | AAL-03-3  |  |
| <b>2525 M16-H</b>                                  | ○                      | ○ | 25  | 25 | 150 | 12.7 |   |   |  |                             |   |                        |                        |  |   |  |

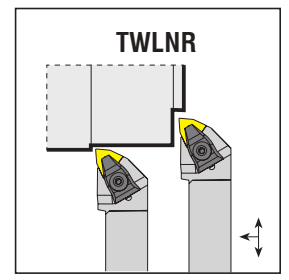
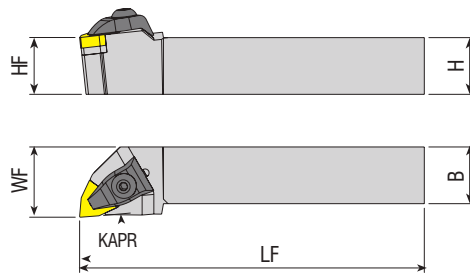

| Takım Kodu<br>Ordering Code<br>Bestell-Bezeichnung | Stok<br>Stock<br>Lager |   | Takım Ölçüleri (mm)<br>Dimension (mm)<br>Abmessung (mm) |    |     |    | Kesici Uç<br>Insert<br>Wendeschneidplatte | Yedek Parçaları / Spare Parts / Ersatzteile |  |                             |   |                         |                      |   |         |          |
|--|------------------------|---|---|----|-----|----|---|---|--|-----------------------------|---|-------------------------|----------------------|---|---------|----------|
|  | R                      | L | HF=H  | B  | LF  | WF |   | Baskı Pabuçu<br>Wedge Clamp<br>Spannpratze  | Pabuç Vidası<br>Clamp Screw<br>Klemmschraube | Altlık<br>Shim<br>Unterlage | Altlık Vidası<br>Shim Screw<br>Schraube für Unterlage | Segman<br>Ring<br>Feder | Pul<br>Stamp<br>Ring | Anahtar<br>Allen Key<br>Innensechskantschlüssel |         |          |
| <b>TWLNR/L 1616 H06</b>                            | ●                      | ● | 16  | 16 | 100 | 20 | <b>WNM. 0604..</b>                        | ATK-01                                      | AKV-01-M5x22                                 | AAWN-SW317                  | AAV-01-M3x10  | -                       | -                    | -   | -       |          |
| <b>2020 K06</b>                                    | ●                      | ● | 20  | 20 | 125 | 25 |   |   |  |                             |   |                         |                      |   |         |          |
| <b>2525 M06</b>                                    | ●                      | ● | 25  | 25 | 150 | 32 |   |   |  |                             |   |                         |                      |   |         |          |
| <b>2020 K08</b>                                    | ●                      | ● | 20  | 20 | 125 | 25 | <b>WNM. 0804..</b>                        | ATK-02                                      | AKV-30-M6x22                                 | AAWN-3-0001                 | AAV-02-M5x12  | AS-01                   | -                    | -   | ABPL-01 | AAL-03-3 |
| <b>2525 M08</b>                                    | ●                      | ● | 25  | 25 | 150 | 32 |   |   |  |                             |   |                         |                      |   |         |          |
| <b>3232 P08</b>                                    | ●                      | ● | 32  | 32 | 170 | 40 |   |   |  |                             |   |                         |                      |   |         |          |
| <b>4040 S08</b>                                    | ●                      | ● | 40  | 40 | 250 | 50 |   |   |  |                             |   |                         |                      |   |         |          |
| <b>5050 S08</b>                                    | ○                      | ○ | 50  | 50 | 250 | 63 |   |   |  |                             |   |                         |                      |   |         |          |

R: Sağ / Right / Rechts L: Sol / Left / Links  
● Stokta / In Stock / Auf Lager ○ Stokta Yok / Non Stock Item / Kein Lagerartikel, Lieferzeit auf Anfrage

Sipariş Örneği/Ordering Example/Bestellbeispiel  
1 ad./pcs./stück TVVNN 2020 H16-H

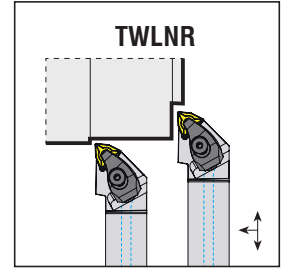
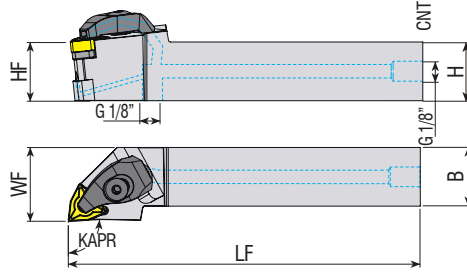

**Takım Kodu**  
**Ordering Code**  
**Bestell-Bezeichnung**

| Stok<br>Stock<br>Lager    | Takım Ölçüleri (mm)<br>Dimension (mm)<br>Abmessung (mm) |   |      |    |     |    | Kesici Uç<br>Insert<br>Wendeschneidplatte | Yedek Parçaları / Spare Parts / Ersatzteile |  |                             |   |                        |                        |  |   |  |  |
|---------------------------|---|---|------|----|-----|----|---|---|--|-----------------------------|---|------------------------|------------------------|--|---|--|--|
|                           | R   | L | HF=H | B  | LF  | WF |   | Baskı Pabuçu<br>Wedge Clamp<br>Spannpratze  | Pabuç Vidası<br>Clamp Screw<br>Klemmschraube | Altlık<br>Shim<br>Unterlage | Altlık Vidası<br>Shim Screw<br>Schraube für Unterlage | Yay<br>Spring<br>Feder | Oring<br>Ring<br>Feder | Sızdırmaz Vida<br>Threaded Pin<br>Резьбовой Винт | Anahtar<br>Allen Key<br>Innensechskantschlüssel |  |  |
|                           |   |   |      |    |     |    |   |   |  |                             |   |                        |                        |  |   |  |  |
| <b>TWLNR/L 2020 K08-H</b> | ●   | ● | 20   | 20 | 125 | 25 | <b>WNM. 0804..</b>                        | ATKH-01-R<br>ATKH-02-L                      | AKV-33-M6x22                                 | AAWN-3-0001                 | AAV-13-M5x8   | AKY-01                 | AXR-01                 | 2705-G1/8x5.5                                    | AAL-03-3  |  |  |
| <b>2525 M08-H</b>         | ●   | ● | 25   | 25 | 150 | 32 |   |   |  |                             |   |                        |                        |  |   |  |  |
| <b>3232 P08-H</b>         | ●   | ● | 32   | 32 | 170 | 40 |   |   |  |                             |   |                        |                        |  |   |  |  |

R: Sağ / Right / Rechts L: Sol / Left / Links

● Stokta / In Stock / Auf Lager ○ Stokta Yok / Non Stock Item / Kein Lagerartikel, Lieferzeit auf Anfrage

Sipariş Örneği/Ordering Example/Bestellbeispiel

1 ad./pcs./stück TWLNR 2020 K08-H



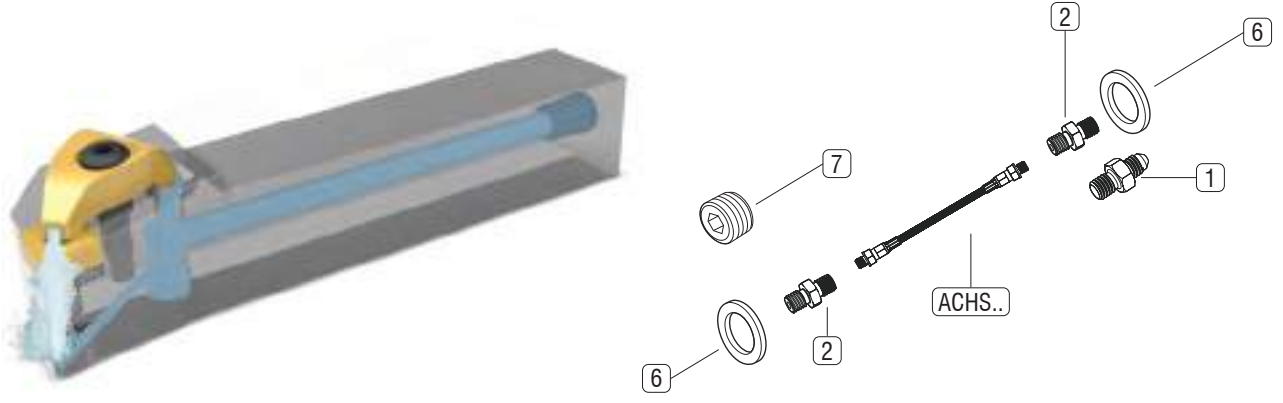

Not: İçten soğutmalı tüm torna katerlerinde kullanılabilen 3 tip soğutma hortum setleri tasarlanmıştır. Takımların kullanılmasından önce, kullanılmayan bağlantıların set içindeki vida ile kapatılarak sızdırmazlığın sağlanmasına dikkat edilmelidir. Torna katerlerine yönelik soğutma hortum setleri, ACHS... 10 bar ile maksimum 275 bar basınç aralığında kullanılabilir.

Note: 3 types of cooling hose sets are designed that can be used in all internally cooled lathes. Before using the tools, care should be taken to ensure that the unused connections are closed with the screw in the set and that sealing is ensured. Cooling hose sets for lathe tools can be used in the pressure range of ACHS ... 10 bar to max 275 bar.

Notiz: Es wurden 3 Arten von Kühlschlauch-Sets entwickelt, die in allen intern gekühlten Drehmaschinen verwendet werden können. Vor der Verwendung der Werkzeuge sollte darauf geachtet werden, dass die nicht verwendeten Verbindungen mit der Schraube im Satz geschlossen werden und die Abdichtung gewährleistet ist. Kühlschlauchsätze für Drehmaschinen können im Druckbereich von ACHS ... 10 bar bis max. 275 bar eingesetzt werden.

| Set İçindeki Parçalar<br>Parts In The Set<br>Teile Im Set |  |               |  | Uzunluk / Length Code / Länge                         |   |   |
|---|--|---------------|--|---|---|---|
|   |  |               |  | Set Kodu:<br>Set Code:<br>Code Einstellen: ACHS-1-250 | Set Kodu:<br>Set Code:<br>Code Einstellen: ACHS-2-250 | Set Kodu:<br>Set Code:<br>Code Einstellen: ACHS-3-250 |
|   |  |               |  |   |   |   |
| 1   |  | AMP-01        | M10 Bağlantı Elemanı<br>M10 Fastener<br>M10 Verschluss                                       | 1x  | -   | -   |
| 2   |  | AMP-02        | G 1/8" Çift Bağlantı Elemanı<br>G 1/8" Double Fastener<br>G 1/8" Doppelverschluss            | 2x  | 1x  | -   |
| 3   |  | AMP-03        | G 1/8" Açılı Bağlantısı<br>G 1/8" Angle Connection<br>G 1/8" Winkelverbindung                | -   | 1x  | 2x  |
| 4   |  | AMP-04        | M10" Açılı Bağlantısı<br>M10" Angle Connection<br>M10" Winkelverbindung                      | -   | 1x  | 1x  |
| 5   |  | AMP-05        | G1/4"-G1/8" Kılcalma Parçası<br>G1 / 4"-G1/8" Capillary Piece<br>G1 / 4"-G1/8" Kapillarstück | -   | 1x  | 1x  |
| 6   |  | AG-01         | Bakır Conta<br>Copper Gasket<br>Kupferdichtung   | 2x  | 3x  | 4x  |
| 7   |  | 2705-G1/8-5.5 | G1/8" Sızdırmaz Civata<br>G1/8" Sealing Bolt<br>G1/8" Dichtungsschraube                      | 1x  | 1x  | 1x  |
| 8   |  | AH-1-250      | Hortum<br>Hose<br>Schlauch   | 1x  | -   | -   |
| 9   |  | AH-2-250      | Hortum<br>Hose<br>Schlauch   | -   | 1x  | -   |
| 10  |  | AH-3-250      | Hortum<br>Hose<br>Schlauch   | -   | -   | 1x  |

# M-SİSTEM

**M-SİSTEM DIŞ TORNA KATERLERİ**  
M-SYSTEM EXTERNAL TURNING TOOLHOLDERS  
M-SYSTEM AUSSEN - DREHHALTER

*konusulan  
the spoken kalite...  
quality...*



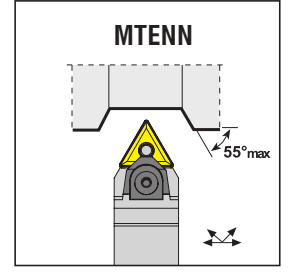
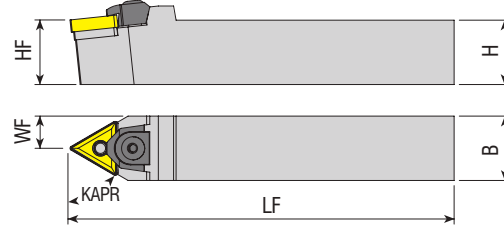

| Takım Kodu<br>Ordering Code<br>Bestell-Bezeichnung | Stok<br>Stock<br>Lager | Takım Ölçüleri (mm)<br>Dimension (mm)<br>Abmessung (mm) |    |     |      | Kesici Uç<br>Insert<br>Wendeschneidplatte | Baskı Pabucu<br>Wedge Clamp<br>Spannpratze | Pabuç Vidası<br>Clamp Screw<br>Klemmschraube | Altlık<br>Shim<br>Unterlage | Pim<br>Pin<br>Штифт | Segman<br>Ring<br>Feder | Pul<br>Stamp<br>Ring | Anahtar<br>Allen Key<br>Innensechskantschlüssel |
|--|------------------------|---|----|-----|------|---|--|--|-----------------------------|---------------------|-------------------------|----------------------|---|
|  |                        | HF=H  | B  | LF  | WF   |   |  |  |                             |                     |                         |                      |   |
| MTENN 2020 K16                                     | ●                      | 20  | 20 | 125 | 10   | TNM. 1604..                               | AMK-04                                     | AKV-30-M6x22                                 | AATN-2-0002                 | APM-01              | AS-01                   | ABPL-01              | AAL-03-3  |
| 2525 M16   | ●                      | 25  | 25 | 150 | 12.5 |   |  |  |                             |                     |                         |                      |   |
| 3232 P16   | ●                      | 32  | 32 | 170 | 16   |   |  |  |                             |                     |                         |                      |   |
| 2525 M22   | ●                      | 25  | 25 | 150 | 12.5 | TNM. 2204..                               | AMK-08                                     | AKV-30-M6x22                                 | AATN-3-0015                 | APM-02              | AS-01                   | ABPL-01              | AAL-03-3  |
| 3232 P22   | ●                      | 32  | 32 | 170 | 16   |   |  |  |                             |                     |                         |                      |   |
| 4040 S22   | ●                      | 40  | 40 | 250 | 20   |   |  |  |                             |                     |                         |                      |   |

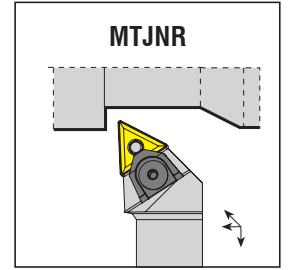
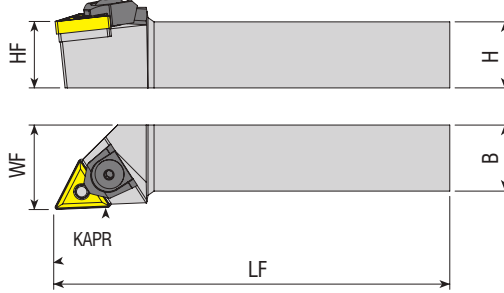

| Takım Kodu<br>Ordering Code<br>Bestell-Bezeichnung | Stok<br>Stock<br>Lager | Takım Ölçüleri (mm)<br>Dimension (mm)<br>Abmessung (mm) |    |      |    | Kesici Uç<br>Insert<br>Wendeschneidplatte | Baskı Pabucu<br>Wedge Clamp<br>Spannpratze | Pabuç Vidası<br>Clamp Screw<br>Klemmschraube | Altlık<br>Shim<br>Unterlage | Pim<br>Pin<br>Штифт | Segman<br>Ring<br>Feder | Pul<br>Stamp<br>Ring | Anahtar<br>Allen Key<br>Innensechskantschlüssel |
|--|------------------------|---|----|------|----|---|--|--|-----------------------------|---------------------|-------------------------|----------------------|---|
|  |                        | R   | L  | HF=H | B  |   |  |  |                             |                     |                         |                      |   |
| MTJNR/L 2020 K16                                   | ● ●                    | 20  | 20 | 125  | 25 | TNM. 1604..                               | AMK-04                                     | AKV-30-M6x22                                 | AATN-2-0002                 | APM-01              | AS-01                   | ABPL-01              | AAL-03-3  |
| 2525 M16   | ● ●                    | 25  | 25 | 150  | 32 |   |  |  |                             |                     |                         |                      |   |
| 3232 P16   | ● ●                    | 32  | 32 | 170  | 40 |   |  |  |                             |                     |                         |                      |   |
| 2525 M22   | ● ●                    | 25  | 25 | 150  | 32 | TNM. 2204..                               | AMK-08                                     | AKV-30-M6x22                                 | AATN-3-0015                 | APM-02              | AS-01                   | ABPL-01              | AAL-03-3  |
| 3232 P22   | ● ●                    | 32  | 32 | 170  | 40 |   |  |  |                             |                     |                         |                      |   |
| 4040 S22   | ● ●                    | 40  | 40 | 250  | 50 |   |  |  |                             |                     |                         |                      |   |

R: Sağ / Right / Rechts L: Sol / Left / Links  
● Stokta / In Stock / Auf Lager ○ Stokta Yok / Non Stock Item / Kein Lagerartikel, Lieferzeit auf Anfrage

Sipariş Örneği/Ordering Example/Bestellbeispiel  
1 ad./pcs./stück MTENN 2020 K16

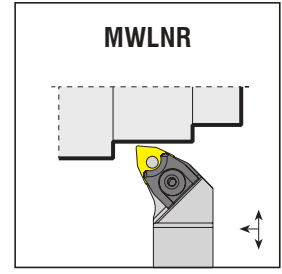
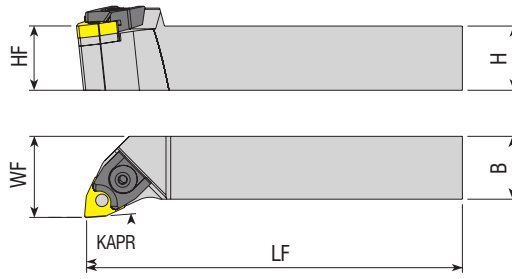

**Takım Kodu**  
**Ordering Code**  
**Bestell-Bezeichnung**

Yedek Parçaları / Spare Parts / Ersatzteile

| Takım Kodu<br>Ordering Code<br>Bestell-Bezeichnung | Stok<br>Stock<br>Lager |   | Takım Ölçüleri (mm)<br>Dimension (mm)<br>Abmessung (mm) |    |     |    | Kesici Uç<br>Insert<br>Wendeschneidplatte | Baskı Pabucu<br>Wedge Clamp<br>Spannpratze | Pabuç Vidası<br>Clamp Screw<br>Klemmschraube | Altık<br>Shim<br>Unterlage | Pim<br>Pin<br>Штифт | Segman<br>Ring<br>Feder | Pul<br>Stamp<br>Ring | Anahtar<br>Allen Key<br>Innensechskantschlüssel |
|--|------------------------|---|---|----|-----|----|---|--|--|----------------------------|---------------------|-------------------------|----------------------|---|
|  | R                      | L | HF=H  | B  | LF  | WF |   |  |  |                            |                     |                         |                      |   |
| <b>MWLNR/L 1616 H06</b>                            | ●                      | ● | 16  | 16 | 100 | 20 | <b>WNM. 0604..</b>                        | AMK-01                                     | AKV-04-M5x17                                 | -                          | APM-08              | -                       | -                    | AAL-03-3  |
| <b>2020 K06</b>                                    | ●                      | ● | 20  | 20 | 125 | 25 |   |  |  |                            |                     |                         |                      |   |
| <b>2525 M06</b>                                    | ●                      | ● | 25  | 25 | 150 | 32 |   |  |  |                            |                     |                         |                      |   |
| <b>2020 K08</b>                                    | ●                      | ● | 20  | 20 | 125 | 25 | <b>WNM. 0804..</b>                        | AMK-05                                     | AKV-03-M6x22                                 | AAWN-3-0001                | APM-02              | AS-01                   | ABPL-01              |   |
| <b>2525 M08</b>                                    | ●                      | ● | 25  | 25 | 150 | 32 |   |  |  |                            |                     |                         |                      |   |
| <b>3232 P08</b>                                    | ●                      | ● | 32  | 32 | 170 | 40 |   |  |  |                            |                     |                         |                      |   |

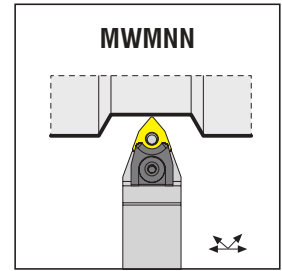
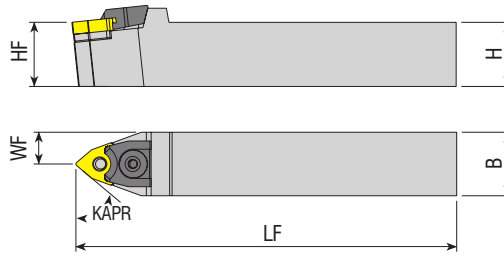

**Takım Kodu**  
**Ordering Code**  
**Bestell-Bezeichnung**

Yedek Parçaları / Spare Parts / Ersatzteile

| Takım Kodu<br>Ordering Code<br>Bestell-Bezeichnung | Stok<br>Stock<br>Lager |   | Takım Ölçüleri (mm)<br>Dimension (mm)<br>Abmessung (mm) |    |     |      | Kesici Uç<br>Insert<br>Wendeschneidplatte | Baskı Pabucu<br>Wedge Clamp<br>Spannpratze | Pabuç Vidası<br>Clamp Screw<br>Klemmschraube | Altık<br>Shim<br>Unterlage | Pim<br>Pin<br>Штифт | Segman<br>Ring<br>Feder | Pul<br>Stamp<br>Ring | Anahtar<br>Allen Key<br>Innensechskantschlüssel |
|--|------------------------|---|---|----|-----|------|---|--|--|----------------------------|---------------------|-------------------------|----------------------|---|
|  | R                      | L | HF=H  | B  | LF  | WF   |   |  |  |                            |                     |                         |                      |   |
| <b>MWMNN 1616 H06</b>                              | ●                      | ● | 16  | 16 | 100 | 8    | <b>WNM. 0604..</b>                        | AMK-01                                     | AKV-04-M5x17                                 | -                          | APM-08              | -                       | -                    | AAL-03-3  |
| <b>2020 K06</b>                                    | ●                      | ● | 20  | 20 | 125 | 10   |   |  |  |                            |                     |                         |                      |   |
| <b>2525 M06</b>                                    | ●                      | ● | 25  | 25 | 150 | 12.5 |   |  |  |                            |                     |                         |                      |   |
| <b>2020 K08</b>                                    | ●                      | ● | 20  | 20 | 125 | 10   | <b>WNM. 0804..</b>                        | AMK-05                                     | AKV-03-M6x22                                 | AAWN-3-0001                | APM-02              | AS-01                   | ABPL-01              |   |
| <b>2525 M08</b>                                    | ●                      | ● | 25  | 25 | 150 | 12.5 |   |  |  |                            |                     |                         |                      |   |
| <b>3232 P08</b>                                    | ●                      | ● | 32  | 32 | 170 | 16   |   |  |  |                            |                     |                         |                      |   |

R: Sağ / Right / Rechts L: Sol / Left / Links

● Stokta / In Stock / Auf Lager ○ Stokta Yok / Non Stock Item / Kein Lagerartikel, Lieferzeit auf Anfrage

Sipariş Örneği/Ordering Example/Bestellbeispiel

1 ad./pcs./stück MWLNR 1616 H06



*konusulan  
the spoken kalite...  
quality...*

# P-SİSTEM

**P-SİSTEM DIŞ TORNA KATERLERİ**  
P-SYSTEM EXTERNAL TURNING TOOLHOLDERS  
P-SYSTEM AUSSEN - DREHHALTER



**DETAYLI BİLGİ İÇİN BARKODU OKUTUNUZ**  
SCAN ME FOR MORE DETAILS  
FÜR DETAILS BITTE DEN QR CODE SCANNEN



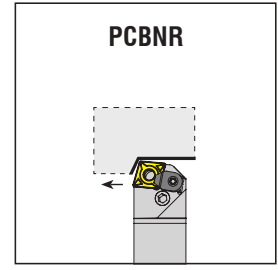
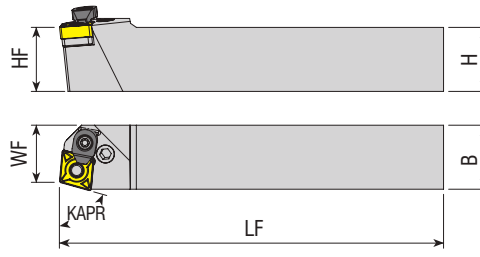

| Takım Kodu<br>Ordering Code<br>Bestell-Bezeichnung | Stok<br>Stock<br>Lager |   | Takım Ölçüleri (mm)<br>Dimension (mm)<br>Abmessung (mm) |    |     |      | Kesici Uç<br>Insert<br>Wendeschneidplatte | Yedek Parçaları / Spare Parts / Ersatzteile |  |                            |  |   |  |   |  |  |
|--|------------------------|---|---|----|-----|------|---|---|--|----------------------------|--|---|--|---|--|--|
|  | R                      | L | HF=H  | B  | LF  | WF   |   | Levye<br>Lever<br>Kniehebel                 | Levye Vidası<br>Lever Screw<br>Kniehebelschraube | Altık<br>Shim<br>Unterlage | Altık Yayı<br>Shim Spring<br>Feder für Unterlage | Baskı Parçası<br>Wedge Clamp<br>Spannpratze | Baskı Vidası<br>Clamp Screw<br>Klemmschraube | Anahtar<br>Allen Key<br>Innerschraubschlüssel |  |  |
|  |                        |   |   |    |     |      |   |   |  |                            |  |   |  |   |  |  |
| <b>PCBNR/L 2020 K12C</b>                           | ●                      | ● | 20  | 20 | 125 | 17.5 |   |   |  |                            |  |   |  |   |  |  |
| <b>2525 M12C</b>                                   | ●                      | ● | 25  | 25 | 150 | 22.5 | <b>CNM. 1204..</b>                        | APL-02                                      | ALV-03-M8x19                                     | AACN-3-0001                | AAY-02   | ACK-05                                      | 4015-M4x11                                   | AAL-03-3                                      |  |  |
| <b>3232 P12C</b>                                   | ●                      | ● | 32  | 32 | 170 | 29.5 |   |   |  |                            |  |   |  |   |  |  |
| <b>2525 M16C</b>                                   | ●                      | ● | 25  | 25 | 150 | 22   | <b>CNM. 1606..</b>                        | APL-04                                      | ALV-04-M8x22                                     | AACN-3-0002                | AAY-03   |   |  |   |  |  |
| <b>3232 P16C</b>                                   | ●                      | ● | 32  | 32 | 170 | 27   |   |   |  |                            |  |   |  |   |  |  |
| <b>3232 P19C</b>                                   | ●                      | ● | 32  | 32 | 170 | 27   | <b>CNM. 1906..</b>                        | APL-05                                      | ALV-05-M10x27                                    | AACN-3-0003                | AAY-04   | ACK-09                                      | AAV-05-M6x15                                 | AAL-05-4                                      |  |  |
| <b>4040 S19C</b>                                   | ●                      | ● | 40  | 40 | 250 | 37   |   |   |  |                            |  |   |  |   |  |  |
| <b>4040 S25C</b>                                   | ●                      | ● | 40  | 40 | 250 | 37   | <b>CNM. 2509..</b>                        | APL-06                                      | ALV-06-M12x36                                    | AACN-3-0008                | AAY-05   | ACK-04                                      | AKV-16-M6x16                                 | AAL-07-5                                      |  |  |
| <b>5050 S25C</b>                                   | ○                      | ○ | 50  | 50 | 250 | 47   |   |   |  |                            |  |   |  |   |  |  |

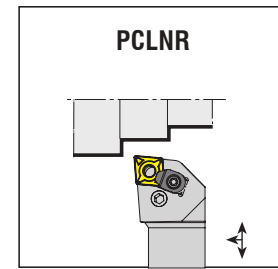
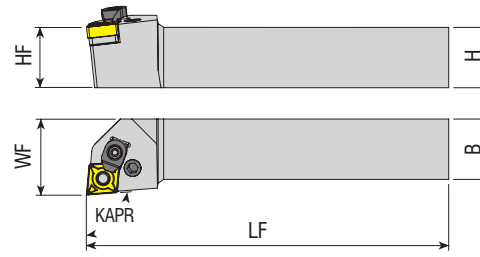

| Takım Kodu<br>Ordering Code<br>Bestell-Bezeichnung | Stok<br>Stock<br>Lager |   | Takım Ölçüleri (mm)<br>Dimension (mm)<br>Abmessung (mm) |    |     |    | Kesici Uç<br>Insert<br>Wendeschneidplatte | Yedek Parçaları / Spare Parts / Ersatzteile |  |                            |  |   |  |   |  |  |
|--|------------------------|---|---|----|-----|----|---|---|--|----------------------------|--|---|--|---|--|--|
|  | R                      | L | HF=H  | B  | LF  | WF |   | Levye<br>Lever<br>Kniehebel                 | Levye Vidası<br>Lever Screw<br>Kniehebelschraube | Altık<br>Shim<br>Unterlage | Altık Yayı<br>Shim Spring<br>Feder für Unterlage | Baskı Parçası<br>Wedge Clamp<br>Spannpratze | Baskı Vidası<br>Clamp Screw<br>Klemmschraube | Anahtar<br>Allen Key<br>Innerschraubschlüssel |  |  |
|  |                        |   |   |    |     |    |   |   |  |                            |  |   |  |   |  |  |
| <b>PCLNR/L 1616 H09</b>                            | ●                      | ● | 16  | 16 | 100 | 20 |   |   |  |                            |  |   |  |   |  |  |
| <b>2020 K09</b>                                    | ●                      | ● | 20  | 20 | 125 | 25 | <b>CNM. 0903..</b>                        | APL-01                                      | ALV-02-M6x17                                     | AACN-2-0002                | AAY-01   | -   | -  | AAL-02-2.5                                    |  |  |
| <b>2525 M09</b>                                    | ●                      | ● | 25  | 25 | 150 | 32 |   |   |  |                            |  |   |  |   |  |  |
| <b>1616 H12</b>                                    | ●                      | ● | 16  | 16 | 100 | 20 |   |   |  |                            |  |   |  |   |  |  |
| <b>2020 K12C</b>                                   | ●                      | ● | 20  | 20 | 125 | 25 | <b>CNM. 1204..</b>                        | APL-02                                      | ALV-03-M8x19                                     | AACN-3-0001                | AAY-02   | ACK-05                                      | 4015-M4x11                                   | AAL-03-3                                      |  |  |
| <b>2525 M12C</b>                                   | ●                      | ● | 25  | 25 | 150 | 32 |   |   |  |                            |  |   |  |   |  |  |
| <b>3232 P12C</b>                                   | ●                      | ● | 32  | 32 | 170 | 40 |   |   |  |                            |  |   |  |   |  |  |
| <b>2525 M16C</b>                                   | ●                      | ● | 25  | 25 | 150 | 32 | <b>CNM. 1606..</b>                        | APL-04                                      | ALV-04-M8x22                                     | AACN-3-0002                | AAY-03   |   |  |   |  |  |
| <b>3232 P16C</b>                                   | ●                      | ● | 32  | 32 | 170 | 40 |   |   |  |                            |  |   |  |   |  |  |
| <b>2525 M19C</b>                                   | ●                      | ● | 25  | 25 | 150 | 32 | <b>CNM. 1906..</b>                        | APL-05                                      | ALV-05-M10x27                                    | AACN-3-0003                | AAY-04   | ACK-09                                      | AAV-05-M6x15                                 | AAL-05-4                                      |  |  |
| <b>3232 P19C</b>                                   | ●                      | ● | 32  | 32 | 170 | 40 |   |   |  |                            |  |   |  |   |  |  |
| <b>4040 S19C</b>                                   | ●                      | ● | 40  | 40 | 250 | 50 |   |   |  |                            |  |   |  |   |  |  |
| <b>4040 S25C</b>                                   | ●                      | ● | 40  | 40 | 250 | 50 | <b>CNM. 2509..</b>                        | APL-06                                      | ALV-06-M12x36                                    | AACN-3-0008                | AAY-05   | ACK-04                                      | AKV-16-M6x16                                 | AAL-07-5                                      |  |  |
| <b>5050 S25C</b>                                   | ●                      | ● | 50  | 50 | 250 | 60 |   |   |  |                            |  |   |  |   |  |  |

R: Sağ / Right / Rechts L: Sol / Left / Links

● Stokta / In Stock / Auf Lager ○ Stokta Yok / Non Stock Item / Kein Lagerartikel, Lieferzeit auf Anfrage

Sipariş Örneği/Ordering Example/Bestellbeispiel

1 ad./pcs./stück PCBNR 2020 K12C

KAPR=95°

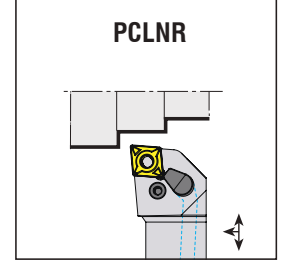
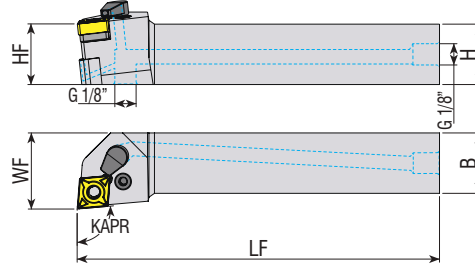

| Takım Kodu<br>Ordering Code<br>Bestell-Bezeichnung | Stok<br>Stock<br>Lager |   | Takım Ölçüleri (mm)<br>Dimension (mm)<br>Abmessung (mm) |    |     |    | Kesici Uç<br>Insert<br>Wendeschneidplatte | Levyeye<br>Lever<br>Kniehebel | Levyeye Vidası<br>Lever Screw<br>Kniehebelschraube | Altılık<br>Shim<br>Unterlage | Altılık Yayını<br>Shim Spring<br>Feder für Unterlage | Oring<br>Ring<br>Feder | Sızdırmaz Vida<br>Threaded Pin<br>Резьбовой Винт | Nozul<br>Spannpratze<br>Spannpratze | Anahtar<br>Allen Key<br>Innensechskantschlüssel |             |        |               |             |        |  |  |          |
|--|------------------------|---|---|----|-----|----|---|-------------------------------|--|------------------------------|--|------------------------|--|-------------------------------------|---|-------------|--------|---------------|-------------|--------|--|--|----------|
|  | R                      | L | HF=H  | B  | LF  | WF |   |                               |  |                              |  |                        |  |                                     |   |             |        |               |             |        |  |  |          |
| PCLNR/L 2020 K12-H                                 | ●                      | ● | 20  | 20 | 125 | 25 | CNM. 1204..                               | APL-02                        | ALV-03-M8x19                                       | AACN-3-0001                  | AAY-02   | AXR-01<br>AOR-01       | 2705-G1/8x5.5                                    | AN-01                               | AAL-03-3  |             |        |               |             |        |  |  |          |
| 2525 M12-H   | ●                      | ● | 25  | 25 | 150 | 32 |   |                               |  |                              |  |                        |  |                                     |   |             |        |               |             |        |  |  |          |
| 3232 P12-H   | ●                      | ○ | 32  | 32 | 170 | 40 |   |                               |  |                              |  |                        |  |                                     |   |             |        |               |             |        |  |  |          |
| <b>new</b> 3232 P16-H                              | ●                      | ○ | 32  | 32 | 170 | 40 |   |                               |  |                              |  |                        |  |                                     |   | CNM. 1606.. | APL-04 | ALV-04-M8x22  | AACN-3-0002 | AAY-03 |  |  | AAL-03-4 |
| <b>new</b> 3232 P19-H                              | ●                      | ○ | 32  | 32 | 170 | 40 |   |                               |  |                              |  |                        |  |                                     |   | CNM. 1906.. | APL-05 | ALV-05-M10x27 | AACN-3-0003 | AAY-04 |  |  | AAL-03-4 |

KAPR=50°

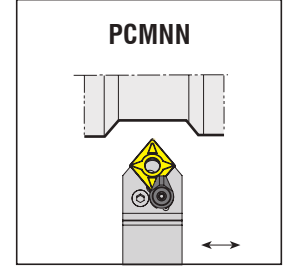
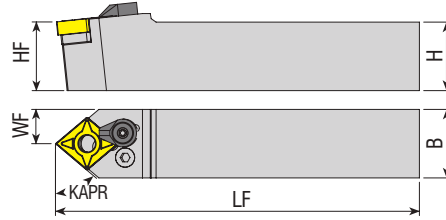

| Takım Kodu<br>Ordering Code<br>Bestell-Bezeichnung | Stok<br>Stock<br>Lager |   | Takım Ölçüleri (mm)<br>Dimension (mm)<br>Abmessung (mm) |    |     |      | Kesici Uç<br>Insert<br>Wendeschneidplatte | Levyeye<br>Lever<br>Kniehebel | Levyeye Vidası<br>Lever Screw<br>Kniehebelschraube | Altılık<br>Shim<br>Unterlage | Altılık Yayını<br>Shim Spring<br>Feder für Unterlage | Baskı Parçası<br>Wedge Clamp<br>Spannpratze | Baskı Vidası<br>Clamp Screw<br>Klemmschraube | Anahtar<br>Allen Key<br>Innensechskantschlüssel |
|--|------------------------|---|---|----|-----|------|---|-------------------------------|--|------------------------------|--|---|--|---|
|  | R                      | L | HF=H  | B  | LF  | WF   |   |                               |  |                              |  |   |  |   |
| PCMNN 2020 K12C                                    | ●                      | ● | 20  | 20 | 125 | 10   | CNM. 1204..                               | APL-02                        | ALV-03-M8x19                                       | AACN-3-0001                  | AAY-02   | ACK-05                                      | 4015-M4x11                                   | AAL-03-3  |
| 2525 M12C  | ●                      | ● | 25  | 25 | 150 | 12.5 |   |                               |  |                              |  |   |  |   |
| 3232 P12C  | ○                      | ○ | 32  | 32 | 170 | 16   |   |                               |  |                              |  |   |  |   |
| 2525 M16C  | ○                      | ○ | 25  | 25 | 150 | 12.5 | CNM. 1606..                               | APL-04                        | ALV-04-M8x22                                       | AACN-3-0002                  | AAY-03   |   |  |   |
| 3232 P16C  | ○                      | ○ | 32  | 32 | 170 | 16   |   |                               |  |                              |  |   |  |   |
| 3232 P19C  | ●                      | ○ | 32  | 32 | 170 | 16   | CNM. 1906..                               | APL-05                        | ALV-05-M10x27                                      | AACN-3-0003                  | AAY-04   | ACK-09                                      | AAV-05-M6x15                                 | AAL-05-4  |
| 4040 S19C  | ●                      | ● | 40  | 40 | 250 | 20   |   |                               |  |                              |  |   |  |   |
| 5050 S19C  | ○                      | ○ | 50  | 50 | 250 | 25   |   |                               |  |                              |  |   |  |   |
| 4040 S25C  | ●                      | ● | 40  | 40 | 250 | 20   | CNM. 2509..                               | APL-06                        | ALV-06-M12x36                                      | AACN-3-0008                  | AAY-05   | ACK-04                                      | AKV-16-M6x16                                 | AAL-07-5  |

R: Sağ / Right / Rechts L: Sol / Left / Links

● Stokta / In Stock / Auf Lager ○ Stokta Yok / Non Stock Item / Kein Lagerartikel, Lieferzeit auf Anfrage

Sipariş Örneği/Ordering Example/Bestellbeispiel

1 ad./pcs./stück PCLNR 2020 K12-H

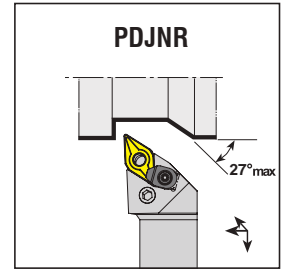
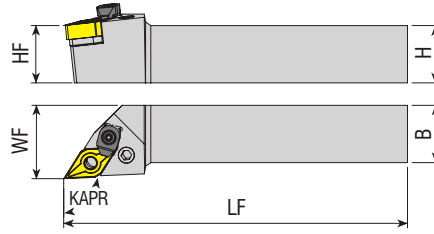

| Takım Kodu<br>Ordering Code<br>Bestell-Bezeichnung | Stok<br>Stock<br>Lager |   | Takım Ölçüleri (mm)<br>Dimension (mm)<br>Abmessung (mm) |    |     |    | Kesici Uç<br>Insert<br>Wendeschneidplatte | Leyve<br>Lever<br>Kniehebel | Leyve Vidası<br>Lever Screw<br>Kniehebelschraube | Altlık<br>Shim<br>Unterlage | Altlık Yayı<br>Shim Spring<br>Feder für Unterlage | Baskı Parçası<br>Wedge Clamp<br>Spannpratze | Baskı Vidası<br>Clamp Screw<br>Klemmschraube | Anahtar<br>Allen Key<br>Inmensechskantschlüssel |
|--|------------------------|---|---|----|-----|----|---|-----------------------------|--|-----------------------------|---|---|--|---|
|  | R                      | L | HF=H  | B  | LF  | WF |   |                             |  |                             |   |   |  |   |
|  |                        |   |   |    |     |    |   |                             |  |                             |   |   |  |   |
| <b>PDJNR/L 1616 H11</b>                            | ●                      | ● | 16  | 16 | 100 | 20 | <b>DNM. 1104..</b>                        | APL-01                      | ALV-02-M6x17                                     | AADN-SD317                  | AAY-01  | -   | -  | AAL-02-2.5                                      |
| <b>2020 K11</b>                                    | ●                      | ● | 20  | 20 | 125 | 25 |   |                             |  |                             |   |   |  |   |
| <b>2525 M11</b>                                    | ●                      | ● | 25  | 25 | 150 | 32 |   |                             |  |                             |   |   |  |   |
| <b>2020 K15C</b>                                   | ●                      | ● | 20  | 20 | 125 | 25 |   |                             |  |                             |   |   |  |   |
| <b>2525 M15C</b>                                   | ●                      | ● | 25  | 25 | 150 | 32 |   |                             |  |                             |   |   |  |   |
| <b>3232 P15C</b>                                   | ●                      | ● | 32  | 32 | 170 | 40 | <b>DNM. 1506..</b>                        | APL-03                      | ALV-03-M8x19                                     | AADN-3-0001                 | AAY-02  | ACK-05                                      | 4015-M4x11                                   | AAL-03-3  |
| <b>4040 S15C</b>                                   | ●                      | ● | 40  | 40 | 250 | 50 |   |                             |  |                             |   |   |  |   |

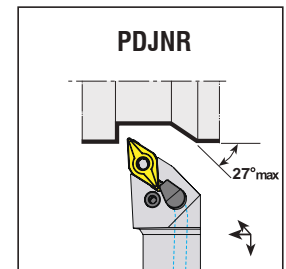
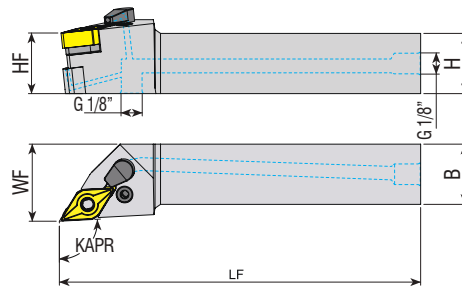

| Takım Kodu<br>Ordering Code<br>Bestell-Bezeichnung | Stok<br>Stock<br>Lager |   | Takım Ölçüleri (mm)<br>Dimension (mm)<br>Abmessung (mm) |    |     |    | Kesici Uç<br>Insert<br>Wendeschneidplatte | Leyve<br>Lever<br>Kniehebel | Leyve Vidası<br>Lever Screw<br>Kniehebelschraube | Altlık<br>Shim<br>Unterlage | Altlık Yayı<br>Shim Spring<br>Feder für Unterlage | Oring<br>Ring<br>Feder | Sızdırmaz Vida<br>Threaded Plug<br>Резьбовой Винт | Nozul<br>Spannpratze<br>Spannpratze | Anahtar<br>Allen Key<br>Inmensechskantschlüssel |
|--|------------------------|---|---|----|-----|----|---|-----------------------------|--|-----------------------------|---|------------------------|---|-------------------------------------|---|
|  | R                      | L | HF=H  | B  | LF  | WF |   |                             |  |                             |   |                        |   |                                     |   |
|  |                        |   |   |    |     |    |   |                             |  |                             |   |                        |   |                                     |   |
| <b>PDJNR/L 2020 K15-H</b>                          | ●                      | ● | 20  | 20 | 125 | 25 | <b>DNM. 1506..</b>                        | APL-03                      | ALV-03-M8x19                                     | AADN-3-0001                 | AAY-02  | AXR-01<br>AOR-01       | 2705-G1/8x5.5                                     | AN-01                               | AAL-03-3  |
| <b>2525 M15-H</b>                                  | ●                      | ● | 25  | 25 | 150 | 32 |   |                             |  |                             |   |                        |   |                                     |   |
| <b>3232 P15-H</b>                                  | ●                      | ○ | 32  | 32 | 170 | 40 |   |                             |  |                             |   |                        |   |                                     |   |

R: Sağ / Right / Rechts L: Sol / Left / Links  
● Stokta / In Stock / Auf Lager ○ Stokta Yok / Non Stock Item / Kein Lagerartikel, Lieferzeit auf Anfrage

Sipariş Örneği/Ordering Example/Bestellbeispiel  
1 ad./pcs./stück PDJNR 1616 H11

KAPR=62.5°

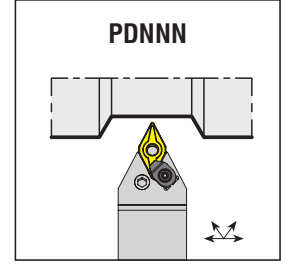
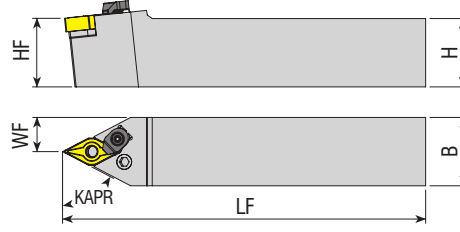

**Takım Kodu**  
**Ordering Code**  
**Bestell-Bezeichnung**

Stok  
Stock  
Lager

Takım Ölçüleri (mm)  
Dimension (mm)  
Abmessung (mm)

Kesici Uç  
Insert  
Wendeschneidplatte

Levyeye  
Lever  
Kniehebel

Levyeye Vidası  
Lever Screw  
Kniehebelschraube

Yedek Parçaları / Spare Parts / Ersatzteile

Afiflik  
Shim  
Unterlage

Afiflik Yayı  
Shim Spring  
Feder für Unterlage

Baskı Parçası  
Wedge Clamp  
Spannpratze

Baskı Vidası  
Clamp Screw  
Klemmschraube

Anahtar  
Allen Key  
Innensechskantschlüssel

HF=H B LF WF



**PDNNN 1616 H11**  
**2020 K11**  
**2525 M11**  
**2020 K15C**  
**2525 M15C**  
**3232 P15C**

● 16 16 100 8  
● 20 20 125 10  
● 25 25 150 12.5  
● 20 20 125 10  
● 25 25 150 12.5  
● 32 32 170 16

**DNM. 1104..**

APL-01

ALV-02-M6x17

AADN-SD317

AAY-01

-

-

AAL-02-2.5

**DNM. 1506..**

APL-03

ALV-03-M8x19

AADN-3-0001

AAY-02

ACK-05

4015-M4x11

AAL-03-3

KAPR=62.5°

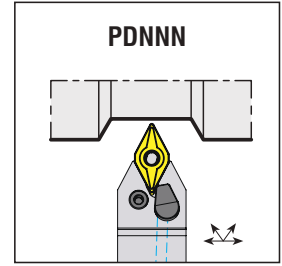
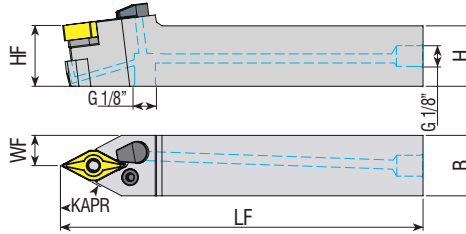

**Takım Kodu**  
**Ordering Code**  
**Bestell-Bezeichnung**

Stok  
Stock  
Lager

Takım Ölçüleri (mm)  
Dimension (mm)  
Abmessung (mm)

Kesici Uç  
Insert  
Wendeschneidplatte

Levyeye  
Lever  
Kniehebel

Levyeye Vidası  
Lever Screw  
Kniehebelschraube

Yedek Parçaları / Spare Parts / Ersatzteile

Afiflik  
Shim  
Unterlage

Afiflik Yayı  
Shim Spring  
Feder für Unterlage

Oring  
Ring  
Feder

Sızdırmaz Vida  
Threaded Pin  
Резьбовой Винт

Nozul  
Spannpratze  
Spannpratze DOW

HF=H B LF WF



**PDNNN 2525 M15-H**

● 25 25 150 32

**DNM. 1506..**

APL-03

ALV-03-M8x19

AADN-3-0001

AAY-02

AXR-01  
AOR-01

2705-G1/8x5.5

AN-01  
AAL-03-3

R: Sağ / Right / Rechts L: Sol / Left / Links

● Stokta / In Stock / Auf Lager ○ Stokta Yok / Non Stock Item / Kein Lagerartikel, Lieferzeit auf Anfrage



www.akko.com.tr

Sipariş Örneği/Ordering Example/Bestellbeispiel

1 ad./pcs./stück PDNNN 1616 H11

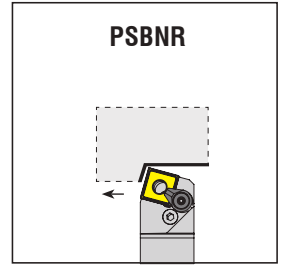
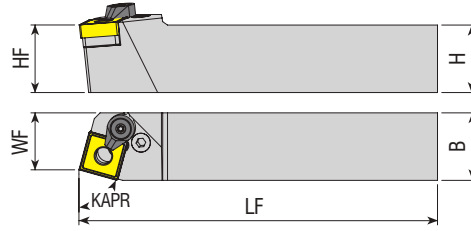

| Takım Kodu<br>Ordering Code<br>Bestell-Bezeichnung | Stok<br>Stock<br>Lager |   | Takım Ölçüleri (mm)<br>Dimension (mm)<br>Abmessung (mm) |    |     |    | Kesici Uç<br>Insert<br>Wendeschneidplatte | Yedek Parçaları / Spare Parts / Ersatzteile |  |                             |  |   |  |  |
|--|------------------------|---|---|----|-----|----|---|---|--|-----------------------------|--|---|--|--|
|  | R                      | L | HF=H  | B  | LF  | WF |   | Levye<br>Lever<br>Kniehebel                 | Levye Vidası<br>Lever Screw<br>Kniehebelschraube | Altlık<br>Shim<br>Unterlage | Altlık Yay<br>Shim Spring<br>Feder für Unterlage | Baskı Parçası<br>Wedge Clamp<br>Spannpratze | Baskı Vidası<br>Clamp Screw<br>Klemmschraube | Anahtar<br>Allen Key<br>Innenschlüssel |
|  |                        |   |   |    |     |    |   |   |  |                             |  |   |  |  |
| <b>PSBNR/L 1616 H09</b>                            | ●                      | ● | 16  | 16 | 100 | 13 | SNM. 0903..                               | APL-01                                      | ALV-02-M6x17                                     | AASN-2-0002                 | AAY-01   | -   | -  | AAL-02-2.5                             |
| <b>2020 K09</b>                                    | ○                      | ○ | 20  | 20 | 125 | 17 |   |   |  |                             |  |   |  |  |
| <b>2020 K12</b>                                    | ●                      | ● | 20  | 20 | 125 | 17 | SNM. 1204..                               | APL-02                                      | ALV-03-M8x19                                     | AASN-3-0004                 | AAY-02   | ACK-05                                      | 4015-M4x11                                   | AAL-03-3                               |
| <b>2525 M12C</b>                                   | ●                      | ● | 25  | 25 | 150 | 22 |   |   |  |                             |  |   |  |  |
| <b>3232 P12C</b>                                   | ●                      | ● | 32  | 32 | 170 | 27 | SNM. 1506..                               | APL-04                                      | ALV-04-M8x22                                     | AASN-3-0023                 | AAY-03   | -   | -  | AAL-05-4                               |
| <b>2525 M15</b>                                    | ●                      | ● | 25  | 25 | 150 | 22 |   |   |  |                             |  |   |  |  |
| <b>3232 P15C</b>                                   | ●                      | ● | 32  | 32 | 170 | 27 | SNM. 1906..                               | APL-05                                      | ALV-05-M10x27                                    | AASN-3-0005                 | AAY-04   | ACK-09                                      | AAV-05-M6x15                                 | AAL-05-4                               |
| <b>3232 P19C</b>                                   | ●                      | ● | 32  | 32 | 170 | 27 |   |   |  |                             |  |   |  |  |
| <b>4040 S19C</b>                                   | ●                      | ● | 40  | 40 | 250 | 35 | SNM. 2509..                               | APL-06                                      | ALV-06-M12x36                                    | AASN-3-0020                 | AAY-05   | ACK-04                                      | AKV-16-M6x16                                 | AAL-07-5                               |
| <b>4040 S25C</b>                                   | ●                      | ● | 40  | 40 | 250 | 35 |   |   |  |                             |  |   |  |  |
| <b>5050 S25C</b>                                   | ●                      | ○ | 50  | 50 | 250 | 43 |   |   |  |                             |  |   |  |  |

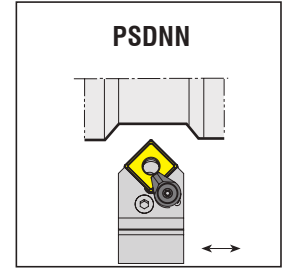
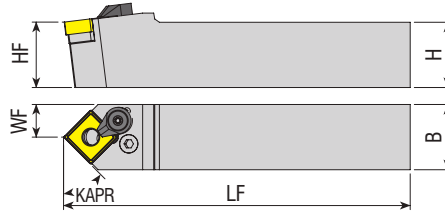

| Takım Kodu<br>Ordering Code<br>Bestell-Bezeichnung | Stok<br>Stock<br>Lager |   | Takım Ölçüleri (mm)<br>Dimension (mm)<br>Abmessung (mm) |    |     |      | Kesici Uç<br>Insert<br>Wendeschneidplatte | Yedek Parçaları / Spare Parts / Ersatzteile |  |                             |  |   |  |  |
|--|------------------------|---|---|----|-----|------|---|---|--|-----------------------------|--|---|--|--|
|  | R                      | L | HF=H  | B  | LF  | WF   |   | Levye<br>Lever<br>Kniehebel                 | Levye Vidası<br>Lever Screw<br>Kniehebelschraube | Altlık<br>Shim<br>Unterlage | Altlık Yay<br>Shim Spring<br>Feder für Unterlage | Baskı Parçası<br>Wedge Clamp<br>Spannpratze | Baskı Vidası<br>Clamp Screw<br>Klemmschraube | Anahtar<br>Allen Key<br>Innenschlüssel |
|  |                        |   |   |    |     |      |   |   |  |                             |  |   |  |  |
| <b>PSDNN 1616 H09</b>                              | ●                      | ● | 16  | 16 | 100 | 8    | SNM. 0903..                               | APL-01                                      | ALV-02-M6x17                                     | AASN-2-0002                 | AAY-01   | -   | -  | AAL-02-2.5                             |
| <b>2020 K12C</b>                                   | ●                      | ● | 20  | 20 | 125 | 10   |   |   |  |                             |  |   |  |  |
| <b>2525 M12C</b>                                   | ●                      | ● | 25  | 25 | 150 | 12.5 | SNM. 1204..                               | APL-02                                      | ALV-03-M8x19                                     | AASN-3-0004                 | AAY-02   | ACK-05                                      | 4015-M4x11                                   | AAL-03-3                               |
| <b>3232 P12C</b>                                   | ●                      | ● | 32  | 32 | 170 | 16   |   |   |  |                             |  |   |  |  |
| <b>2020 K15</b>                                    | ●                      | ● | 20  | 20 | 125 | 10   | SNM. 1506..                               | APL-04                                      | ALV-04-M8x22                                     | AASN-3-0023                 | AAY-03   | -   | -  | AAL-05-4                               |
| <b>2525 M15C</b>                                   | ●                      | ● | 25  | 25 | 150 | 12.5 |   |   |  |                             |  |   |  |  |
| <b>3232 P19C</b>                                   | ●                      | ● | 32  | 32 | 170 | 16   | SNM. 1906..                               | APL-05                                      | ALV-05-M10x27                                    | AASN-3-0005                 | AAY-04   | ACK-09                                      | AAV-05-M6x15                                 | AAL-05-4                               |
| <b>4040 S19C</b>                                   | ○                      | ○ | 40  | 40 | 250 | 20   |   |   |  |                             |  |   |  |  |
| <b>5050 S19C</b>                                   | ○                      | ○ | 50  | 50 | 250 | 25   | SNM. 2509..                               | APL-06                                      | ALV-06-M12x36                                    | AASN-3-0020                 | AAY-05   | ACK-04                                      | AKV-16-M6x16                                 | AAL-07-5                               |
| <b>4040 S25C</b>                                   | ●                      | ● | 40  | 40 | 250 | 20   |   |   |  |                             |  |   |  |  |
| <b>5050 S25C</b>                                   | ○                      | ○ | 50  | 50 | 250 | 25   |   |   |  |                             |  |   |  |  |

R: Sağ / Right / Rechts L: Sol / Left / Links

● Stokta / In Stock / Auf Lager ○ Stokta Yok / Non Stock Item / Kein Lagerartikel, Lieferzeit auf Anfrage

Sipariş Örneği/Ordering Example/Bestellbeispiel

1 ad./pcs./stück PSBNR 1616 H09

KAPR=75°

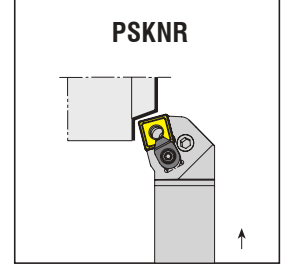
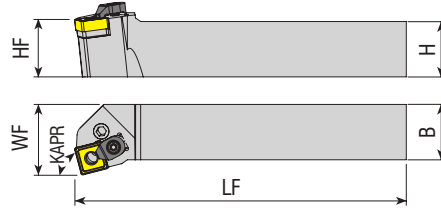

**Takım Kodu**  
**Ordering Code**  
*Bestell-Bezeichnung*

Stok  
Stock  
Lager

Takım Ölçüleri (mm)  
Dimension (mm)  
Abmessung (mm)

Kesici Uç  
Insert  
Wendeschneidplatte

Levyeye  
Lever  
Kniehebel

Levyeye Vidası  
Lever Screw  
Kniehebelschraube

Aitlik  
Shim  
Unterlage

Aitlik Yayı  
Shim Spring  
Feder für Unterlage

Baskı Parçası  
Wedge Clamp  
Spannpratze

Baskı Vidası  
Clamp Screw  
Klemmschraube

Anahtar  
Allen Key  
Innensechskantschlüssel

R L

HF=H

B

LF

WF

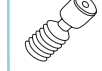

**PSKNR/L 2020 K09**  
**2020 K12C**  
**2525 M12C**  
**3232 P12C**  
**2525 M15C**  
**3232 P15C**  
**3232 P19C**  
**4040 S19C**  
**4040 S25C**  
**5050 S25C**

● ○ ● ● ● ● ● ● ● ● ● ○

20 20 25 25 25 32 32 32 40 40 50

20 20 25 25 25 32 32 32 40 40 50

125 125 150 170 150 170 170 250 250 250

25 25 32 40 32 40 40 50 50 60

**SNM. 0903..**  
**SNM. 1204..**  
**SNM. 1506..**  
**SNM. 1906..**  
**SNM. 2509..**

APL-01  
APL-02  
APL-04  
APL-05  
APL-06

ALV-02-M6x17  
ALV-03-M8x19  
ALV-04-M8x22  
ALV-05-M10x27  
ALV-06-M12x36

AASN-2-0002  
AASN-3-0004  
AASN-3-0023  
AASN-3-0005  
AASN-3-0020

AAAY-01  
AAAY-02  
AAAY-03  
AAAY-04  
AAAY-05

-  
ACK-05  
ACK-09  
ACK-04

-  
4015-M4x11  
AAV-05-M6x15  
AKV-16-M6x16

AAL-02-2.5  
AAL-03-3  
AAL-05-4  
AAL-07-5

KAPR=45°

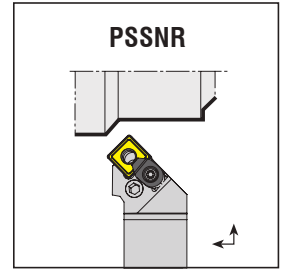
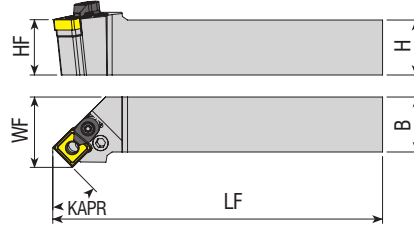

**Takım Kodu**  
**Ordering Code**  
*Bestell-Bezeichnung*

Stok  
Stock  
Lager

Takım Ölçüleri (mm)  
Dimension (mm)  
Abmessung (mm)

Kesici Uç  
Insert  
Wendeschneidplatte

Levyeye  
Lever  
Kniehebel

Levyeye Vidası  
Lever Screw  
Kniehebelschraube

Aitlik  
Shim  
Unterlage

Aitlik Yayı  
Shim Spring  
Feder für Unterlage

Baskı Parçası  
Wedge Clamp  
Spannpratze

Baskı Vidası  
Clamp Screw  
Klemmschraube

Anahtar  
Allen Key  
Innensechskantschlüssel

R L

HF=H

B

LF

WF



**PSSNR/L 1616 H09**  
**2020 K09**  
**2020 K12C**  
**2525 M12C**  
**3232 P12C**  
**3232 P15C**  
**3232 P19C**  
**4040 S19C**  
**4040 S25C**

● ● ● ● ● ● ● ● ● ●

16 20 20 25 32 32 32 40 40

16 20 20 25 32 32 32 40 40

100 125 125 150 170 170 170 250 250

20 25 25 32 40 40 40 50 50

**SNM. 0903..**  
**SNM. 1204..**  
**SNM. 1506..**  
**SNM. 1906..**  
**SNM. 2509..**

APL-01  
APL-02  
APL-04  
APL-05  
APL-06

ALV-02-M6x17  
ALV-03-M8x19  
ALV-04-M8x22  
ALV-05-M10x27  
ALV-06-M12x36

AASN-2-0002  
AASN-3-0004  
AASN-3-0023  
AASN-3-0005  
AASN-3-0020

AAAY-01  
AAAY-02  
AAAY-03  
AAAY-04  
AAAY-05

-  
ACK-05  
ACK-09  
ACK-04

-  
4015-M4x11  
AAV-05-M6x15  
AKV-16-M6x16

AAL-02-2.5  
AAL-03-3  
AAL-05-4  
AAL-07-5

R: Sağ / Right / Rechts L: Sol / Left / Links

● Stokta / In Stock / Auf Lager ○ Stokta Yok / Non Stock Item / Kein Lagerartikel, Lieferzeit auf Anfrage

Sipariş Örneği/Ordering Example/Bestellbeispiel/

1 ad./pcs./stück PSKNR 2020 K09

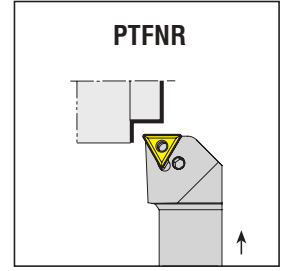
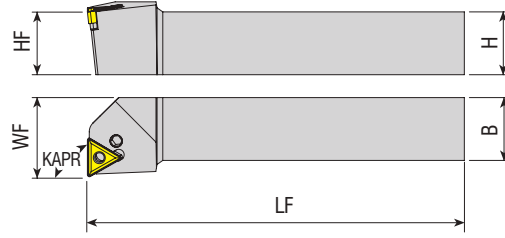

**Takım Kodu**  
**Ordering Code**  
**Bestell-Bezeichnung**

| Takım Kodu<br>Ordering Code<br>Bestell-Bezeichnung | Stok<br>Stock<br>Lager |   | Takım Ölçüleri (mm)<br>Dimension (mm)<br>Abmessung (mm) |    |     |    | Kesici Uç<br>Insert<br>Wendeschneidplatte | Yedek Parçaları / Spare Parts / Ersatzteile |  |                              |   |   |  |   |
|--|------------------------|---|---|----|-----|----|---|---|--|------------------------------|---|---|--|---|
|  | R                      | L | HF=H  | B  | LF  | WF |   | Levyeye<br>Lever<br>Kniehebel               | Levyeye Vidası<br>Lever Screw<br>Kniehebelschraube | Altılık<br>Shim<br>Unterlage | Altılık Yay<br>Shim Spring<br>Feder für Unterlage | Baskı Parçası<br>Wedge Clamp<br>Spannpratze | Baskı Vidası<br>Clamp Screw<br>Klemmschraube | Anahtar<br>Allen Key<br>Innensechskantschlüssel |
| <b>PTFNR/L 1616 H16</b>                            | ●                      | ● | 16  | 16 | 100 | 20 | <b>TNM. 1604..</b>                        | APL-01                                      | ALV-02-M6x17                                       | AATN-3-0025                  | AAY-01  | -   | -  | AAL-02-2.5                                      |
| <b>2020 K16</b>                                    | ●                      | ● | 20  | 20 | 125 | 25 |   |   |  |                              |   |   |  |   |
| <b>2525 M16</b>                                    | ●                      | ● | 25  | 25 | 150 | 32 |   |   |  |                              |   |   |  |   |
| <b>3232 P16</b>                                    | ●                      | ● | 32  | 32 | 170 | 40 |   |   |  |                              |   |   |  |   |
| <b>2525 M22C</b>                                   | ●                      | ● | 25  | 25 | 150 | 32 | <b>TNM. 2204..</b>                        | APL-02                                      | ALV-03-M8x19                                       | AATN-3-0015                  | AAY-02  | ACK-05                                      | 4015-M4x11                                   | AAL-03-3  |
| <b>3232 P22C</b>                                   | ●                      | ● | 32  | 32 | 170 | 40 |   |   |  |                              |   |   |  |   |
| <b>4040 S27C</b>                                   | ○                      | ○ | 40  | 40 | 250 | 50 | <b>TNM. 2706..</b>                        | APL-05                                      | ALV-05-M10x27                                      | AATN-3-0027                  | AAY-04  | ACK-09                                      | AAV-05-M6x15                                 | AAL-05-4  |

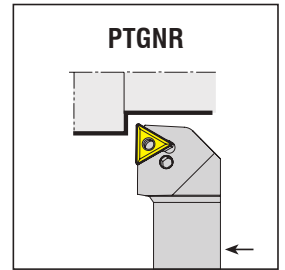
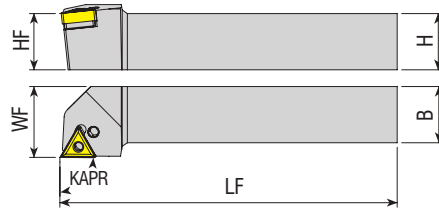

**Takım Kodu**  
**Ordering Code**  
**Bestell-Bezeichnung**

| Takım Kodu<br>Ordering Code<br>Bestell-Bezeichnung | Stok<br>Stock<br>Lager |   | Takım Ölçüleri (mm)<br>Dimension (mm)<br>Abmessung (mm) |    |     |    | Kesici Uç<br>Insert<br>Wendeschneidplatte | Yedek Parçaları / Spare Parts / Ersatzteile |  |                              |   |   |  |   |
|--|------------------------|---|---|----|-----|----|---|---|--|------------------------------|---|---|--|---|
|  | R                      | L | HF=H  | B  | LF  | WF |   | Levyeye<br>Lever<br>Kniehebel               | Levyeye Vidası<br>Lever Screw<br>Kniehebelschraube | Altılık<br>Shim<br>Unterlage | Altılık Yay<br>Shim Spring<br>Feder für Unterlage | Baskı Parçası<br>Wedge Clamp<br>Spannpratze | Baskı Vidası<br>Clamp Screw<br>Klemmschraube | Anahtar<br>Allen Key<br>Innensechskantschlüssel |
| <b>PTGNR/L 1010 E11</b>                            | ○                      | ○ | 10  | 10 | 70  | 12 | <b>TNM. 1103..</b>                        | APL-11                                      | ALV-10-M5x10                                       | -                            | -   | -   | -  | AAL-13-2.5                                      |
| <b>1212 F11</b>                                    | ○                      | ○ | 12  | 12 | 80  | 16 |   |   |  |                              |   |   |  |   |
| <b>1616 H11</b>                                    | ○                      | ○ | 16  | 16 | 100 | 20 |   |   |  |                              |   |   |  |   |
| <b>1616 H16</b>                                    | ●                      | ● | 16  | 16 | 100 | 20 | <b>TNM. 1604..</b>                        | APL-01                                      | ALV-02-M6x17                                       | AATN-3-0025                  | AAY-01  | -   | -  | AAL-02-2.5                                      |
| <b>2020 K16</b>                                    | ●                      | ● | 20  | 20 | 125 | 25 |   |   |  |                              |   |   |  |   |
| <b>2525 M16</b>                                    | ●                      | ● | 25  | 25 | 150 | 32 |   |   |  |                              |   |   |  |   |
| <b>3232 P16</b>                                    | ○                      | ○ | 32  | 32 | 170 | 40 |   |   |  |                              |   |   |  |   |
| <b>2525 M22C</b>                                   | ●                      | ● | 25  | 25 | 150 | 32 | <b>TNM. 2204..</b>                        | APL-02                                      | ALV-03-M8x19                                       | AATN-3-0015                  | AAY-02  | ACK-05                                      | 4015-M4x11                                   | AAL-03-3  |
| <b>3232 P22C</b>                                   | ●                      | ● | 32  | 32 | 170 | 40 |   |   |  |                              |   |   |  |   |
| <b>4040 S27C</b>                                   | ○                      | ○ | 40  | 40 | 250 | 50 | <b>TNM. 2706..</b>                        | APL-05                                      | ALV-05-M10x27                                      | AATN-3-0027                  | AAY-04  | ACK-09                                      | AAV-05-M6x15                                 | AAL-05-4  |

R: Sağ / Right / Rechts L: Sol / Left / Links  
● Stokta / In Stock / Auf Lager ○ Stokta Yok / Non Stock Item / Kein Lagerartikel, Lieferzeit auf Anfrage

Sipariş Örneği/Ordering Example/Bestellbeispiel  
1 ad./pcs./stück PTFNR 1616 H16

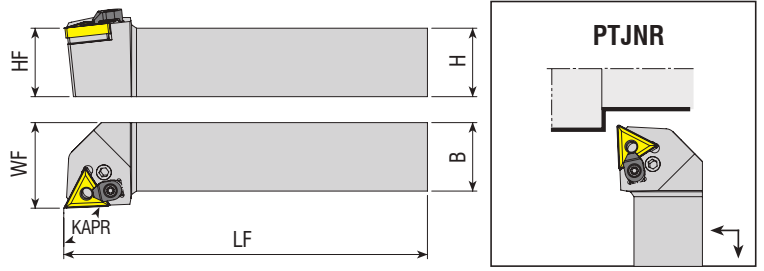

| Takım Kodu<br>Ordering Code<br>Bestell-Bezeichnung | Stok<br>Stock<br>Lager |   | Takım Ölçüleri (mm)<br>Dimension (mm)<br>Abmessung (mm) |    |     |    | Kesici Uç<br>Insert<br>Wendeschneidplatte | Yedek Parçaları / Spare Parts / Ersatzteile |  |                              |   |   |  |   |
|--|------------------------|---|---|----|-----|----|---|---|--|------------------------------|---|---|--|---|
|  | R                      | L | HF=H  | B  | LF  | WF |   | Levyeye<br>Lever<br>Kniehebel               | Levyeye Vidası<br>Lever Screw<br>Kniehebelschraube | Altılık<br>Shim<br>Unterlage | Altılık Yay<br>Shim Spring<br>Feder für Unterlage | Baskı Parçası<br>Wedge Clamp<br>Spannpratze | Baskı Vidası<br>Clamp Screw<br>Klemmschraube | Anahtar<br>Allen Key<br>Innensechskantschlüssel |
|  | ○                      | ○ |   |    |     |    |   |   |  |                              |   |   |  |   |
| <b>PTJNR/L 1010 E11</b>                            | ○                      | ○ | 10  | 10 | 70  | 12 | <b>TNM. 1103..</b>                        | APL-11                                      | ALV-10-M5x10                                       | -                            | -   | -   | -  | AAL-13-2.5                                      |
| <b>1212 F11</b>                                    | ○                      | ○ | 12  | 12 | 80  | 16 |   |   |  |                              |   |   |  |   |
| <b>1616 H11</b>                                    | ○                      | ○ | 16  | 16 | 100 | 20 |   |   |  |                              |   |   |  |   |
| <b>1616 H16</b>                                    | ●                      | ● | 16  | 16 | 100 | 20 | <b>TNM. 1604..</b>                        | APL-01                                      | ALV-02-M6x17                                       | AATN-3-0025                  | AAY-01  | -   | -  | AAL-02-2.5                                      |
| <b>2020 K16</b>                                    | ●                      | ● | 20  | 20 | 125 | 25 |   |   |  |                              |   |   |  |   |
| <b>2525 M16</b>                                    | ●                      | ● | 25  | 25 | 150 | 32 |   |   |  |                              |   |   |  |   |
| <b>3232 P16</b>                                    | ●                      | ● | 32  | 32 | 170 | 40 | <b>TNM. 2204..</b>                        | APL-02                                      | ALV-03-M8x19                                       | AATN-3-0015                  | AAY-02  | ACK-05                                      | 4015-M4x11                                   | AAL-03-3  |
| <b>2525 M22C</b>                                   | ●                      | ● | 25  | 25 | 150 | 32 |   |   |  |                              |   |   |  |   |
| <b>3232 P22C</b>                                   | ●                      | ● | 32  | 32 | 170 | 40 |   |   |  |                              |   |   |  |   |
| <b>4040 S27C</b>                                   | ●                      | ○ | 40  | 40 | 250 | 50 | <b>TNM. 2706..</b>                        | APL-05                                      | ALV-05-M10x27                                      | AATN-3-0027                  | AAY-04  | ACK-09                                      | AAV-05-M6x15                                 | AAL-05-4  |

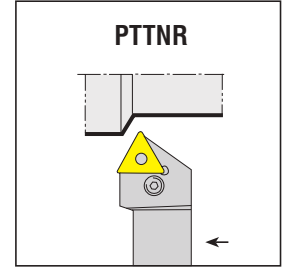
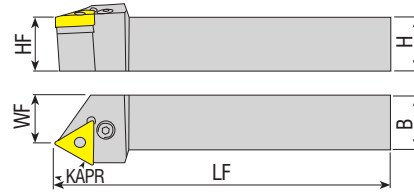

| Takım Kodu<br>Ordering Code<br>Bestell-Bezeichnung | Stok<br>Stock<br>Lager |   | Takım Ölçüleri (mm)<br>Dimension (mm)<br>Abmessung (mm) |    |     |      | Kesici Uç<br>Insert<br>Wendeschneidplatte | Yedek Parçaları / Spare Parts / Ersatzteile |  |                              |   |   |  |   |
|--|------------------------|---|---|----|-----|------|---|---|--|------------------------------|---|---|--|---|
|  | R                      | L | HF=H  | B  | LF  | WF   |   | Levyeye<br>Lever<br>Kniehebel               | Levyeye Vidası<br>Lever Screw<br>Kniehebelschraube | Altılık<br>Shim<br>Unterlage | Altılık Yay<br>Shim Spring<br>Feder für Unterlage | Baskı Parçası<br>Wedge Clamp<br>Spannpratze | Baskı Vidası<br>Clamp Screw<br>Klemmschraube | Anahtar<br>Allen Key<br>Innensechskantschlüssel |
|  | ○                      | ○ |   |    |     |      |   |   |  |                              |   |   |  |   |
| <b>PTTNR/L 1616 H16</b>                            | ●                      | ● | 16  | 16 | 100 | 13   | <b>TNM. 1604..</b>                        | APL-01                                      | ALV-02-M6x17                                       | AATN-3-0025                  | AAY-01  | -   | -  | AAL-02-2.5                                      |
| <b>2020 K16</b>                                    | ●                      | ● | 20  | 20 | 125 | 17   |   |   |  |                              |   |   |  |   |
| <b>2525 M16</b>                                    | ●                      | ● | 25  | 25 | 150 | 21.5 |   |   |  |                              |   |   |  |   |
| <b>3232 P16</b>                                    | ●                      | ● | 32  | 32 | 170 | 31   | <b>TNM. 2204..</b>                        | APL-02                                      | ALV-03-M8x19                                       | AATN-3-0015                  | AAY-02  | ACK-05                                      | 4015-M4x11                                   | AAL-03-3  |
| <b>2525 M22C</b>                                   | ●                      | ● | 25  | 25 | 150 | 20.5 |   |   |  |                              |   |   |  |   |
| <b>3232 P22C</b>                                   | ●                      | ● | 32  | 32 | 170 | 29   |   |   |  |                              |   |   |  |   |

R: Sağ / Right / Rechts L: Sol / Left / Links  
● Stokta / In Stock / Auf Lager ○ Stokta Yok / Non Stock Item / Kein Lagerartikel, Lieferzeit auf Anfrage

Sipariş Örneği/Ordering Example/Bestellbeispiel  
1 ad./pcs./stück PTJNR 1010 E11



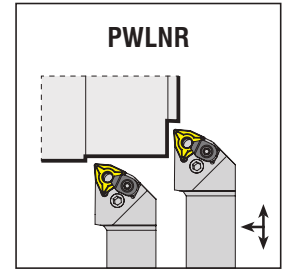
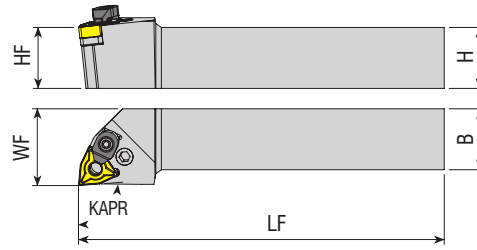

| Takım Kodu<br>Ordering Code<br>Bestell-Bezeichnung | Stok<br>Stock<br>Lager |   | Takım Ölçüleri (mm)<br>Dimension (mm)<br>Abmessung (mm) |    |     |    | Kesici Uç<br>Insert<br>Wendeschneidplatte | Yedek Parçaları / Spare Parts / Ersatzteile |              |             |             |               |              |                         |
|--|------------------------|---|---|----|-----|----|---|---|--------------|-------------|-------------|---------------|--------------|-------------------------|
|  | R                      | L | HF=H  | B  | LF  | WF |   | Levye                                       | Levye Vidası | Altlık      | Altlık Yayı | Baskı Parçası | Baskı Vidası | Anahtar                 |
|  |                        |   |   |    |     |    |   | Lever                                       | Lever Screw  | Shim        | Shim Spring | Wedge Clamp   | Clamp Screw  | Innensechskantschlüssel |
| <b>PWLNRL 1616 H06</b>                             | ●                      | ● | 16  | 16 | 100 | 20 | <b>WNM. 0604..</b>                        | APL-01                                      | ALV-02-M6x17 | AAWN-SW317  | AAY-01      | -             | -            | AAL-02-2.5              |
| <b>2020 K06</b>                                    | ●                      | ● | 20  | 20 | 125 | 25 |   |   |              |             |             |               |              |                         |
| <b>2525 M06</b>                                    | ●                      | ● | 25  | 25 | 150 | 32 |   |   |              |             |             |               |              |                         |
| <b>3232 P06</b>                                    | ○                      | ○ | 32  | 32 | 170 | 40 |   |   |              |             |             |               |              |                         |
| <b>1616 H08</b>                                    | ●                      | ● | 16  | 16 | 100 | 20 | <b>WNM. 0804..</b>                        | APL-02                                      | ALV-03-M8x19 | AAWN-3-0001 | AAY-02      | ACK-05        | 4015-M4x11   | AAL-03-3                |
| <b>2020 K08C</b>                                   | ●                      | ● | 20  | 20 | 125 | 25 |   |   |              |             |             |               |              |                         |
| <b>2525 M08C</b>                                   | ●                      | ● | 25  | 25 | 150 | 32 |   |   |              |             |             |               |              |                         |
| <b>3232 P08C</b>                                   | ●                      | ● | 32  | 32 | 170 | 40 |   |   |              |             |             |               |              |                         |

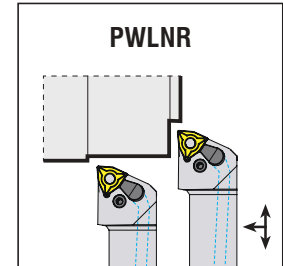
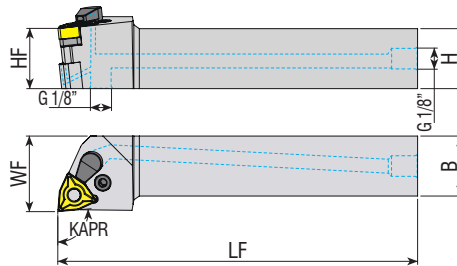

| Takım Kodu<br>Ordering Code<br>Bestell-Bezeichnung | Stok<br>Stock<br>Lager |   | Takım Ölçüleri (mm)<br>Dimension (mm)<br>Abmessung (mm) |    |     |    | Kesici Uç<br>Insert<br>Wendeschneidplatte | Yedek Parçaları / Spare Parts / Ersatzteile |              |             |             |        |                |             |                         |  |  |
|--|------------------------|---|---|----|-----|----|---|---|--------------|-------------|-------------|--------|----------------|-------------|-------------------------|--|--|
|  | R                      | L | HF=H  | B  | LF  | WF |   | Levye                                       | Levye Vidası | Altlık      | Altlık Yayı | Oring  | Sızdırmaz Vida | Nozul       | Anahtar                 |  |  |
|  |                        |   |   |    |     |    |   | Lever                                       | Lever Screw  | Shim        | Shim Spring | Ring   | Threaded Pin   | Spannpratze | Innensechskantschlüssel |  |  |
| <b>PWLNRL 2020 K08-H</b>                           | ●                      | ● | 20  | 20 | 125 | 25 | <b>WNM. 0804..</b>                        | APL-02                                      | ALV-03-M8x19 | AAWN-3-0001 | AAY-02      | AXR-01 | 2705-G1/8x5.5  | AN-01       | AAL-03-3                |  |  |
| <b>2525 M08-H</b>                                  | ●                      | ● | 25  | 25 | 150 | 32 |   |   |              |             |             |        |                |             |                         |  |  |

R: Sağ / Right / Rechts L: Sol / Left / Links

● Stokta / In Stock / Auf Lager ○ Stokta Yok / Non Stock Item / Kein Lagerartikel, Lieferzeit auf Anfrage

Sipariş Örneği/Ordering Example/Bestellbeispiel

1 ad./pcs./stück PWLNRL 1616 H06



KAPR=93°

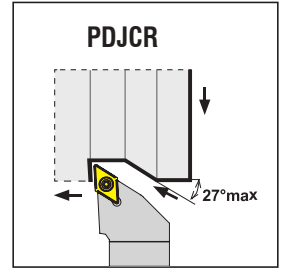
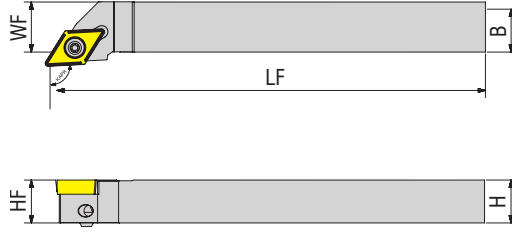

| Takım Kodu<br>Ordering Code<br>Bestell-Bezeichnung | Stok<br>Stock<br>Lager |   | Takım Ölçüleri (mm)<br>Dimension (mm)<br>Abmessung (mm) |    |     |    | Kesici Uç<br>Insert<br>Wendeschneidplatte | Yedek Parçaları / Spare Parts / Ersatzteile |  |                              |  |   |  |   |        |
|--|------------------------|---|---|----|-----|----|---|---|--|------------------------------|--|---|--|---|--------|
|  | R                      | L | HF=H  | B  | LF  | WF |   | Levyeye<br>Lever<br>Kniehebel               | Levyeye Vidası<br>Lever Screw<br>Kniehebelschraube | Altılık<br>Shim<br>Unterlage | Altılık Yayı<br>Shim Spring<br>Feder für Unterlage | Baskı Parçası<br>Wedge Clamp<br>Spannpratze | Baskı Vidası<br>Clamp Screw<br>Klemmschraube | Anahtar<br>Allen Key<br>Innensechskantschlüssel |        |
| PDJCR/L 1010 K11-S                                 | ●                      | ○ | 10  | 10 | 125 | 10 | DC.T 11T3..                               | APL-14                                      | 2802-M4x8  | -                            | -  | -   | -  | AAL-01-02                                       |        |
| 1212 K11-S   | ●                      | ○ | 12  | 12 | 125 | 12 |   |   |  |                              |  |   |  |   | APL-15 |
| 1616 K11-S   | ●                      | ○ | 16  | 16 | 125 | 16 |   |   |  |                              |  |   |  |   |        |

R: Sağ / Right / Rechts L: Sol / Left / Links  
● Stokta / In Stock / Auf Lager ○ Stokta Yok / Non Stock Item / Kein Lagerartikel, Lieferzeit auf Anfrage  
ISO Uçuna Uygundur. / Compatible with ISO Insert. / Под пластину ISO Wendeplatten.

Sipariş Örneği/Ordering Example/Bestellbeispiel  
1 ad./pcs./stück PDJCR 1010 K11-S



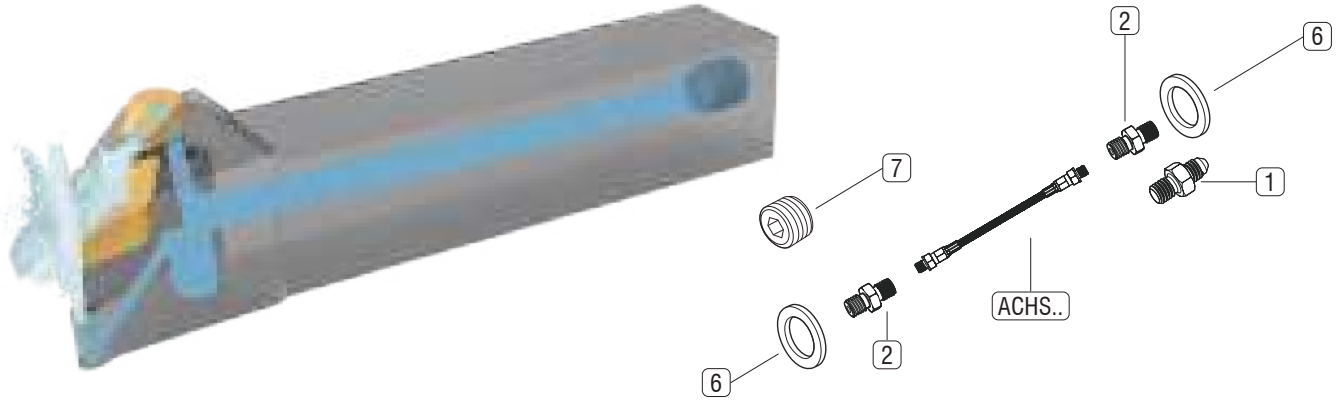

Not: İçten soğutmalı tüm torna katerlerinde kullanılacak 3 tip soğutma hortum setleri tasarlanmıştır. Takımların kullanılmasından önce, kullanılmayan bağlantıların set içindeki vida ile kapatılarak sızdırmazlığın sağlanmasına dikkat edilmelidir. Torna katerlerine yönelik soğutma hortum setleri, ACHS... 10 bar ile maksimum 275 bar basınç aralığında kullanılabilir.

Note: 3 types of cooling hose sets are designed that can be used in all internally cooled lathes. Before using the tools, care should be taken to ensure that the unused connections are closed with the screw in the set and that sealing is ensured. Cooling hose sets for lathe tools can be used in the pressure range of ACHS ... 10 bar to max 275 bar.

Notiz: Es wurden 3 Arten von Kühlschlauch-Sets entwickelt, die in allen intern gekühlten Drehmaschinen verwendet werden können. Vor der Verwendung der Werkzeuge sollte darauf geachtet werden, dass die nicht verwendeten Verbindungen mit der Schraube im Satz geschlossen werden und die Abdichtung gewährleistet ist. Kühlschlauchsätze für Drehmaschinen können im Druckbereich von ACHS ... 10 bar bis max. 275 bar eingesetzt werden.

| Set İçindeki Parçalar<br>Parts In The Set<br>Teile im Set |   |  |    | Uzunluk / Length Code / Länge              |  |  |
|---|---|--|----|--|--|--|
|   |   |  |    | Set Kodu:<br>Set Code:<br>Code Einstellen: | Set Kodu:<br>Set Code:<br>Code Einstellen: | Set Kodu:<br>Set Code:<br>Code Einstellen: |
|   |   |  |    | ACHS-1-250                                 | ACHS-2-250                                 | ACHS-3-250                                 |
| Resim<br>Picture<br>Bild                                  | Takım Kodu<br>Set Code<br>Code Einstellen | Ürün Açıklaması<br>Product Description<br>Artikelbeschreibung                            |    |  |  |  |
| 1   | AMP-01                                    | M10 Bağlantı Elemanı<br>M10 Fastener<br>M10 Verschluss                                   | 1x | -  | -  |  |
| 2   | AMP-02                                    | G 1/8" Çift Bağlantı Elemanı<br>G 1/8" Double Fastener<br>G 1/8" Doppelverschluss        | 2x | 1x   | -  |  |
| 3   | AMP-03                                    | G 1/8" Açılı Bağlantısı<br>G 1/8" Angle Connection<br>G 1/8" Winkelverbindung            | -  | 1x   | 2x   |  |
| 4   | AMP-04                                    | M10" Açılı Bağlantısı<br>M10" Angle Connection<br>M10" Winkelverbindung                  | -  | 1x   | 1x   |  |
| 5   | AMP-05                                    | G1/4"-G1/8" Kılcalma Parçası<br>G1/4"-G1/8" Capillary Piece<br>G1/4"-G1/8" Kapillarstück | -  | 1x   | 1x   |  |
| 6   | AG-01                                     | Bakır Conta<br>Copper Gasket<br>Kupferdichtung   | 2x | 3x   | 4x   |  |
| 7   | 2705-G1/8-5.5                             | G1/8" Sızdırmaz Civata<br>G1/8" Sealing Bolt<br>G1/8" Dichtungsschraube                  | 1x | 1x   | 1x   |  |
| 8   | AH-1-250                                  | Hortum<br>Hose<br>Schlauch   | 1x | -  | -  |  |
| 9   | AH-2-250                                  | Hortum<br>Hose<br>Schlauch   | -  | 1x   | -  |  |
| 10  | AH-3-250                                  | Hortum<br>Hose<br>Schlauch   | -  | -  | 1x   |  |



*konusulan  
the spoken kalite...  
quality...*

# C-SİSTEM

**C-SİSTEM DIŞ TORNA KATERLERİ**  
C-SYSTEM EXTERNAL TURNING TOOLHOLDERS  
C-SYSTEM AUSSEN - DREHHALTER



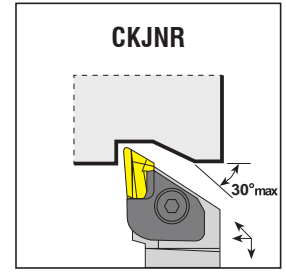
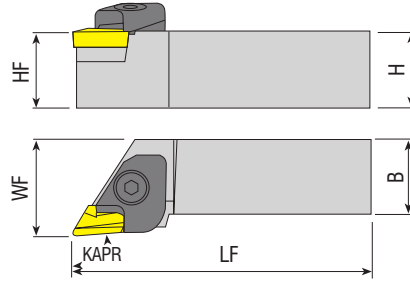

**Takım Kodu**  
**Ordering Code**  
*Bestell-Bezeichnung*

| Takım Kodu<br>Ordering Code<br>Bestell-Bezeichnung | Stok<br>Stock<br>Lager |   | Takım Ölçüleri (mm)<br>Dimension (mm)<br>Abmessung (mm) |    |     |      | Kesici Uç<br>Insert<br>Wendeschneldplatte | Yedek Parçaları / Spare Parts / Ersatzteile |  |                             |   |                        |                      |   |
|--|------------------------|---|---|----|-----|------|---|---|--|-----------------------------|---|------------------------|----------------------|---|
|  | R                      | L | HF=H  | B  | LF  | WF   |   | Baskı Pabucu<br>Wedge Clamp<br>Spannpratze  | Pabuç Vidası<br>Clamp Screw<br>Klemmschraube | Altlık<br>Shim<br>Unterlage | Altlık Vidası<br>Shim Screw<br>Schraube für Unterlage | Yay<br>Spring<br>Feder | Pul<br>Stamp<br>Ring | Anahtar<br>Allen Key<br>Innensechskantschlüssel |
| <b>CKJNR/L 2020 K16</b>                            | ●                      | ● | 20  | 20 | 125 | 27.5 | <b>KNUX 1604..</b>                        |   |  |                             |   |                        |                      |   |
| <b>2525 M16</b>                                    | ●                      | ● | 25  | 25 | 150 | 31.5 |   |   |  |                             |   |                        |                      |   |
| <b>3232 P16</b>                                    | ●                      | ● | 32  | 32 | 170 | 40   |   |   |  |                             |   |                        |                      |   |
| <b>4040 S16</b>                                    | ●                      | ● | 40  | 40 | 250 | 50   |   |   |  |                             |   |                        |                      |   |

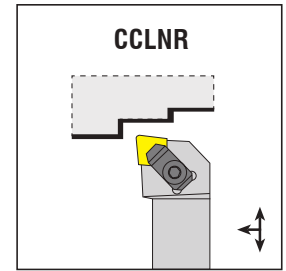
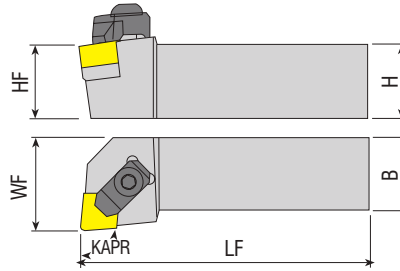

**Takım Kodu**  
**Ordering Code**  
*Bestell-Bezeichnung*

| Takım Kodu<br>Ordering Code<br>Bestell-Bezeichnung | Stok<br>Stock<br>Lager |   | Takım Ölçüleri (mm)<br>Dimension (mm)<br>Abmessung (mm) |    |     |    | Kesici Uç<br>Insert<br>Wendeschneldplatte | Yedek Parçaları / Spare Parts / Ersatzteile |  |                             |   |                         |   |  |
|--|------------------------|---|---|----|-----|----|---|---|--|-----------------------------|---|-------------------------|---|--|
|  | R                      | L | HF=H  | B  | LF  | WF |   | Baskı Pabucu<br>Wedge Clamp<br>Spannpratze  | Pabuç Vidası<br>Clamp Screw<br>Klemmschraube | Altlık<br>Shim<br>Unterlage | Altlık Vidası<br>Shim Screw<br>Schraube für Unterlage | Segman<br>Ring<br>Feder | Anahtar<br>Allen Key<br>Innensechskantschlüssel |  |
| <b>CCLNR/L 2525 M1207C</b>                         | ●                      | ● | 25  | 25 | 150 | 32 | <b>CN.N 1207..</b>                        |   |  |                             |   |                         |   |  |
| <b>3232 P1207C</b>                                 | ●                      | ● | 32  | 32 | 170 | 40 |   |   |  |                             |   |                         |   |  |
| <b>2525 M1607C</b>                                 | ●                      | ● | 25  | 25 | 150 | 32 | <b>CN.N 1607..</b>                        |   |  |                             |   |                         |   |  |

R: Sağ / Right / Rechts L: Sol / Left / Links

● Stokta / In Stock / Auf Lager ○ Stokta Yok / Non Stock Item / Kein Lagerartikel, Lieferzeit auf Anfrage

Sipariş Örneği/Ordering Example/Bestellbeispiel

1 ad./pcs./stück CKJNR 2020 K16

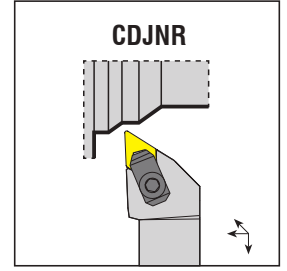
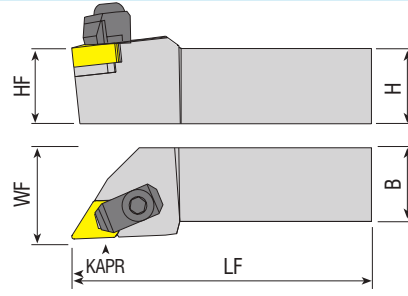

| Takım Kodu<br>Ordering Code<br>Bestell-Bezeichnung | Stok<br>Stock<br>Lager |   | Takım Ölçüleri (mm)<br>Dimension (mm)<br>Abmessung (mm) |    |     |    | Kesici Uç<br>Insert<br>Wendeschneidplatte | Yedek Parçaları / Spare Parts / Ersatzteile |  |                             |   |                         |   |
|--|------------------------|---|---|----|-----|----|---|---|--|-----------------------------|---|-------------------------|---|
|  | R                      | L | HF=H  | B  | LF  | WF |   | Baskı Pabucu<br>Wedge Clamp<br>Spannpratze  | Pabuç Vidası<br>Clamp Screw<br>Klemmschraube | Aitlik<br>Shim<br>Unterlage | Aitlik Vidası<br>Shim Screw<br>Schraube für Unterlage | Segman<br>Ring<br>Feder | Anahtar<br>Allen Key<br>Innensechskantschlüssel |
| CDJNR/L 2525 M1107C                                | ●                      | ● | 25  | 25 | 150 | 32 | DN.N 1107..                               | ACK-22                                      | AKV-11-M8x29                                 | AADN-2-0001                 | AAV-04-M5x12  | ACS-01                  | AAL-05-4  |
| 2525 M1507C  | ●                      | ● | 25  | 25 | 150 | 32 | DN.N 1507..                               | ACK-13                                      | AKV-11-M8x29                                 | AADN-3-0001                 | AAV-02-M5x12  | ACS-01                  | AAL-05-4  |
| 3232 P1507C  | ●                      | ● | 32  | 32 | 170 | 40 |   |   |  |                             |   |                         |   |

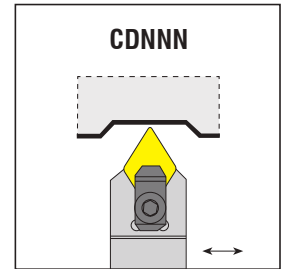
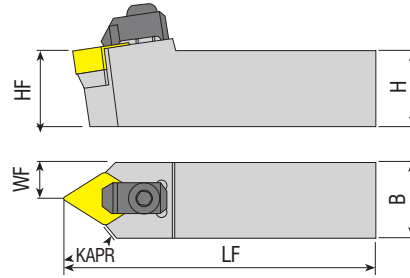

| Takım Kodu<br>Ordering Code<br>Bestell-Bezeichnung | Stok<br>Stock<br>Lager |   | Takım Ölçüleri (mm)<br>Dimension (mm)<br>Abmessung (mm) |    |     |      | Kesici Uç<br>Insert<br>Wendeschneidplatte | Yedek Parçaları / Spare Parts / Ersatzteile |  |                             |   |                         |   |
|--|------------------------|---|---|----|-----|------|---|---|--|-----------------------------|---|-------------------------|---|
|  | R                      | L | HF=H  | B  | LF  | WF   |   | Baskı Pabucu<br>Wedge Clamp<br>Spannpratze  | Pabuç Vidası<br>Clamp Screw<br>Klemmschraube | Aitlik<br>Shim<br>Unterlage | Aitlik Vidası<br>Shim Screw<br>Schraube für Unterlage | Segman<br>Ring<br>Feder | Anahtar<br>Allen Key<br>Innensechskantschlüssel |
| CDNNN 2525 M1107C                                  | ●                      |   | 25  | 25 | 150 | 12.5 | DN.N 1107..                               | ACK-22                                      | AKV-11-M8x29                                 | AADN-2-0001                 | AAV-04-M5x12  | ACS-01                  | AAL-05-4  |

R: Sağ / Right / Rechts L: Sol / Left / Links

● Stokta / In Stock / Auf Lager ○ Stokta Yok / Non Stock Item / Kein Lagerartikel, Lieferzeit auf Anfrage

Sipariş Örneği/Ordering Example/Bestellbeispiel

1 ad./pcs./stück CDJNR 2525 M1107C

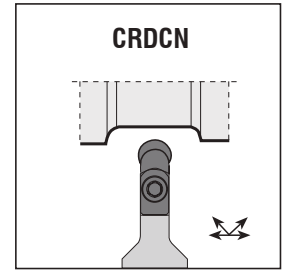
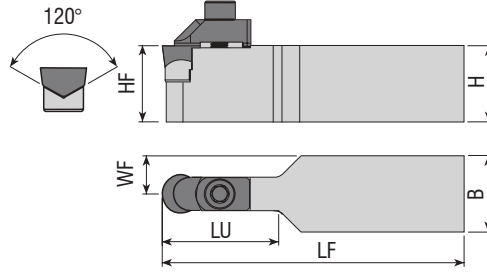

**Takım Kodu**  
**Ordering Code**  
**Bestell-Bezeichnung**

| Stok<br>Stock<br>Lager  | Takım Ölçüleri (mm)<br>Dimension (mm)<br>Abmessung (mm) |    |    |     |    | Kesici Uç<br>Insert<br>Wendeschnidplatte | Yedek Parçaları / Spare Parts / Ersatzteile |  |                            |  |   |            |
|-------------------------|---|----|----|-----|----|--|---|--|----------------------------|--|---|------------|
|                         | HF=H  | B  | LF | LU  | WF |  | Baskı Pabucu<br>Wedge Clamp<br>Spannpratze  | Pabuç Vidası<br>Clamp Screw<br>Klemmschraube | Altık<br>Shim<br>Unterlage | Altık Vidası<br>Shim Screw<br>Schraube für Unterlage | Anahtar<br>Allen Key<br>Innensechskantschlüssel |            |
| <b>CRDCN 2525 M06CV</b> | ●   | 25 | 25 | 150 | 19 | 12.5                                     | <b>RCGX 0606..</b>                          | ACK-27                                       | 2525-M3X14                 | AARC-3-0001  | 3007-M2.2X4.6                                   | AAL-02-2.5 |
| <b>3225 P06CV</b>       | ●   | 32 | 25 | 170 | 19 | 12.5                                     |   |  |                            |  |   |            |
| <b>4040 S06CV</b>       | ●   | 40 | 40 | 250 | 19 | 20                                       |   |  |                            |  |   |            |
| <b>2525 M09CV</b>       | ●   | 25 | 25 | 150 | 29 | 12.5                                     | <b>RCGX 0907..</b>                          | ACK-28                                       | 2504-M5X16                 | AARC-3-0002  | 3008-M2.5x6                                     | AAL-05-4   |
| <b>3225 P09CV</b>       | ●   | 32 | 25 | 170 | 29 | 12.5                                     |   |  |                            |  |   |            |
| <b>4040 S09CV</b>       | ●   | 40 | 40 | 250 | 29 | 20                                       |   |  |                            |  |   |            |
| <b>2525 M12CV</b>       | ●   | 25 | 25 | 150 | 38 | 12.5                                     | <b>RCGX 1207..</b>                          | ACK-29                                       | 2505-M6X20                 | AARC-3-0003  | 3008-M2.5x6                                     | AAL-07-5   |
| <b>3225 P12CV</b>       | ●   | 32 | 25 | 170 | 38 | 12.5                                     |   |  |                            |  |   |            |
| <b>4040 S12CV</b>       | ●   | 40 | 40 | 250 | 38 | 20                                       |   |  |                            |  |   |            |

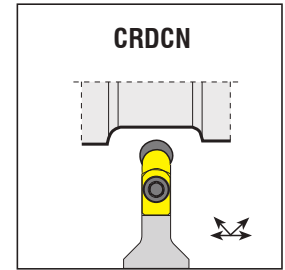
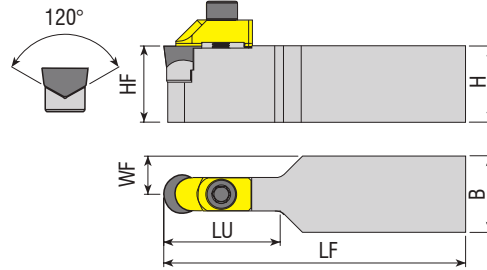

**Takım Kodu**  
**Ordering Code**  
**Bestell-Bezeichnung**

| Stok<br>Stock<br>Lager   | Takım Ölçüleri (mm)<br>Dimension (mm)<br>Abmessung (mm) |    |    |     |    | Kesici Uç<br>Insert<br>Wendeschnidplatte | Yedek Parçaları / Spare Parts / Ersatzteile |  |                            |  |   |            |
|--------------------------|---|----|----|-----|----|--|---|--|----------------------------|--|---|------------|
|                          | HF=H  | B  | LF | LU  | WF |  | Baskı Pabucu<br>Wedge Clamp<br>Spannpratze  | Pabuç Vidası<br>Clamp Screw<br>Klemmschraube | Altık<br>Shim<br>Unterlage | Altık Vidası<br>Shim Screw<br>Schraube für Unterlage | Anahtar<br>Allen Key<br>Innensechskantschlüssel |            |
| <b>CRDCN 3232 P06CVK</b> | ●   | 32 | 32 | 170 | 19 | 16                                       | <b>RCGX 060600</b>                          | ACK-42                                       | 2525-M3x12                 | AARC-3-0005  | 2008-M2.5X12                                    | AAL-02-2.5 |
| <b>4040 R06CVK</b>       | ●   | 40 | 40 | 200 | 19 | 20                                       |   |  |                            |  |   |            |
| <b>3232 P09CVK</b>       | ●   | 32 | 32 | 170 | 29 | 16                                       | <b>RCGX 090700</b>                          | ACK-43                                       | 2504-M5x14                 | AARC-3-0006  | 4015-M3.5x14                                    | AAL-05-4   |
| <b>4040 R09CVK</b>       | ●   | 40 | 40 | 200 | 29 | 20                                       |   |  |                            |  |   |            |
| <b>3232 P12CVK</b>       | ●   | 32 | 32 | 170 | 38 | 16                                       | <b>RCGX 120700</b>                          | ACK-44                                       | 2505-M6x16                 | AARC-3-0007  | 1620-M5x18                                      | AAL-07-5   |
| <b>4040 R12CVK</b>       | ●   | 40 | 40 | 200 | 38 | 20                                       |   |  |                            |  |   |            |

R: Sağ / Right / Rechts L: Sol / Left / Links

● Stokta / In Stock / Auf Lager ○ Stokta Yok / Non Stock Item / Kein Lagerartikel, Lieferzeit auf Anfrage

Sipariş Örneği/Ordering Example/Bestellbeispiel  
1 ad./pcs./stück CRDCN 2525 M06CV

**C-SİSTEM SERAMİK UÇLAR İÇİN DİŞ TORNA KATERLERİ**  
**C-SYSTEM EXTERNAL TURNING TOOLHOLDERS FOR CERAMIC INSERTS**  
**C-SYSTEM AUSSEN - DREHHALTER FÜR KERAMIK WENDESCHNEIDPLATTEN**

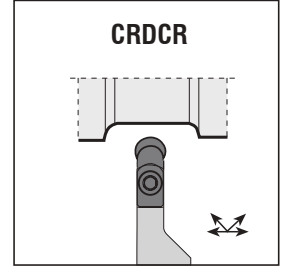
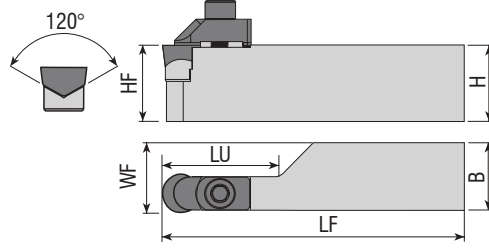

**Takım Kodu**  
**Ordering Code**  
*Bestell-Bezeichnung*

| Stok<br>Stock<br>Lager | Takım Ölçüleri (mm)<br>Dimension (mm)<br>Abmessung (mm) |   |      |    |     |      | Kesici Uç<br>Insert<br>Wendeschneidplatte | Yedek Parçaları / Spare Parts / Ersatzteile |  |  |                             |   |   |
|------------------------|---|---|------|----|-----|------|---|---|--|--|-----------------------------|---|---|
|                        | R   | L | HF=H | B  | LF  | LU   |   | WF  | Baskı Pabucu<br>Wedge Clamp<br>Spannpratze | Pabuç Vidası<br>Clamp Screw<br>Klemmschraube | Altlık<br>Shim<br>Unterlage | Altlık Vidası<br>Shim Screw<br>Schraube für Unterlage | Anahtar<br>Allen Key<br>Innensechskantschlüssel |
| CRDCR/L 3225 P06CV     | ●   | ● | 32   | 25 | 170 | 19.4 | 25.6                                      | RCGX 0606..                                 | ACK-27                                     | 2525-M3X14                                   | AARC-3-0001                 | 3007-M2.2X4.6   | AAL-02-2.5                                      |
| 3225 P09CV             | ●   | ● | 32   | 25 | 170 | 29   | 25.8                                      | RCGX 0907..                                 | ACK-28                                     | 2504-M5X16                                   | AARC-3-0002                 | 3008-M2.5x6   | AAL-05-4  |
| 3225 P12CV             | ●   | ● | 32   | 25 | 170 | 38.5 | 25.9                                      | RCGX 1207..                                 | ACK-29                                     | 2505-M6X20                                   | AARC-3-0003                 | 3008-M2.5x6   | AAL-07-5  |



KAPR=45°

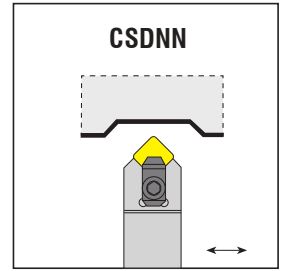
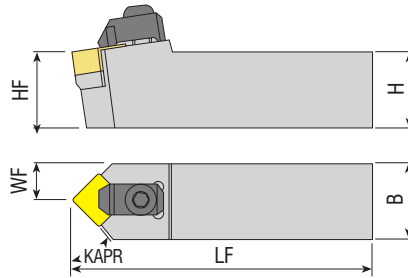

**Takım Kodu**  
**Ordering Code**  
*Bestell-Bezeichnung*

| Stok<br>Stock<br>Lager | Takım Ölçüleri (mm)<br>Dimension (mm)<br>Abmessung (mm) |    |    |     |  | Kesici Uç<br>Insert<br>Wendeschneidplatte | Yedek Parçaları / Spare Parts / Ersatzteile  |                             |   |                         |   |          |
|------------------------|---|----|----|-----|--|---|--|-----------------------------|---|-------------------------|---|----------|
|                        | HF=H  | B  | LF | WF  | Baskı Pabucu<br>Wedge Clamp<br>Spannpratze |   | Pabuç Vidası<br>Clamp Screw<br>Klemmschraube | Altlık<br>Shim<br>Unterlage | Altlık Vidası<br>Shim Screw<br>Schraube für Unterlage | Segman<br>Ring<br>Feder | Anahtar<br>Allen Key<br>Innensechskantschlüssel |          |
| CSDNN 2525 M1207C      | ●   | 25 | 25 | 150 | 12.5                                       | SN.N 1207..                               | ACK-13                                       | AKV-11-M8x29                | AASN-3-0004   | AAV-02-M5x12            | ACS-01  | AAL-05-4 |
| 3232 P1207C            | ●   | 32 | 32 | 170 | 16   |   |  |                             |   |                         |   |          |

R: Sağ / Right / Rechts L: Sol / Left / Links

● Stokta / In Stock / Auf Lager ○ Stokta Yok / Non Stock Item / Kein Lagerartikel, Lieferzeit auf Anfrage

Sipariş Örneği/Ordering Example/Bestellbeispiel

1 ad./pcs./stück CRDCR 3225 P06CV



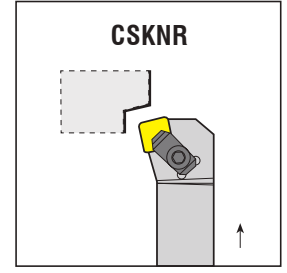
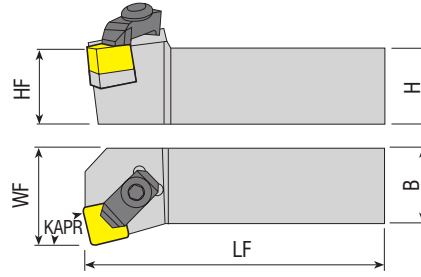

| Takım Kodu<br>Ordering Code<br>Bestell-Bezeichnung | Stok<br>Stock<br>Lager |   | Takım Ölçüleri (mm)<br>Dimension (mm)<br>Abmessung (mm) |    |     |    | Kesici Uç<br>Insert<br>Wendeschneidplatte | Yedek Parçaları / Spare Parts / Ersatzteile |  |                             |   |                         |  |
|--|------------------------|---|---|----|-----|----|---|---|--|-----------------------------|---|-------------------------|--|
|  | R                      | L | HF=H  | B  | LF  | WF |   | Baskı Pabucu<br>Wedge Clamp<br>Spannpratze  | Pabuç Vidası<br>Clamp Screw<br>Klemmschraube | Altlık<br>Shim<br>Unterlage | Altlık Vidası<br>Shim Screw<br>Schraube für Unterlage | Segman<br>Ring<br>Feder | Anahtar<br>Allen Key<br>Innenschlüssel |
| CSKNR/L 2525 M1207C<br>3232 P1207C                 | ●                      | ● | 25  | 25 | 150 | 32 | SN.N 1207..                               | ACK-13                                      | AKV-11-M8x29                                 | AASN-3-0004                 | AAV-02-M5x12  | ACS-01                  | AAL-05-4                               |
|  | ●                      | ● | 32  | 32 | 170 | 40 |   |   |  |                             |   |                         |  |

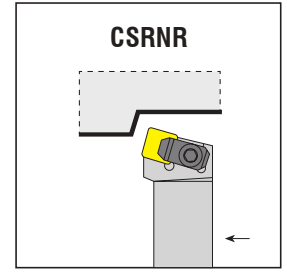
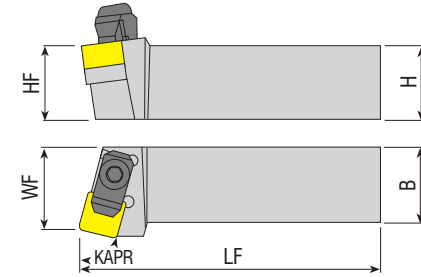

| Takım Kodu<br>Ordering Code<br>Bestell-Bezeichnung | Stok<br>Stock<br>Lager |   | Takım Ölçüleri (mm)<br>Dimension (mm)<br>Abmessung (mm) |    |     |    | Kesici Uç<br>Insert<br>Wendeschneidplatte | Yedek Parçaları / Spare Parts / Ersatzteile |  |                             |   |                         |  |
|--|------------------------|---|---|----|-----|----|---|---|--|-----------------------------|---|-------------------------|--|
|  | R                      | L | HF=H  | B  | LF  | WF |   | Baskı Pabucu<br>Wedge Clamp<br>Spannpratze  | Pabuç Vidası<br>Clamp Screw<br>Klemmschraube | Altlık<br>Shim<br>Unterlage | Altlık Vidası<br>Shim Screw<br>Schraube für Unterlage | Segman<br>Ring<br>Feder | Anahtar<br>Allen Key<br>Innenschlüssel |
| CSRNR/L 2525 M1207C<br>3232 P1207C                 | ●                      | ● | 25  | 25 | 150 | 32 | SN.N 1207..                               | ACK-13                                      | AKV-11-M8x29                                 | AASN-3-0004                 | AAV-02-M5x12  | ACS-01                  | AAL-05-4                               |
|  | ●                      | ● | 32  | 32 | 170 | 40 |   |   |  |                             |   |                         |  |

R: Sağ / Right / Rechts L: Sol / Left / Links

● Stokta / In Stock / Auf Lager ○ Stokta Yok / Non Stock Item / Kein Lagerartikel, Lieferzeit auf Anfrage

Sipariş Örneği/Ordering Example/Bestellbeispiel

1 ad./pcs./stück CSKNR 2525 M1207C

**C-SİSTEM SERAMİK UÇLAR İÇİN DİŞ TORNA KATERLERİ**  
**C-SYSTEM EXTERNAL TURNING TOOLHOLDERS FOR CERAMIC INSERTS**  
**C-SYSTEM AUSSEN - DREHALTER FÜR KERAMIK WENDESCHNEIDPLATTEN**

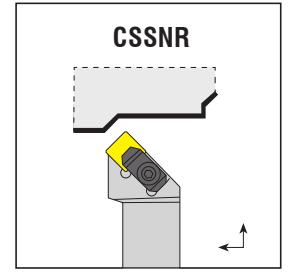
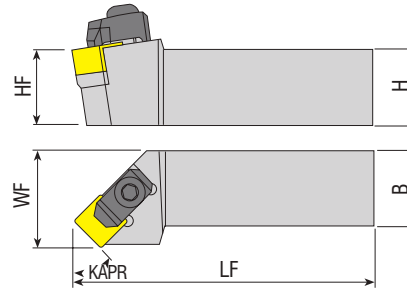

| Takım Kodu<br>Ordering Code<br>Bestell-Bezeichnung | Stok<br>Stock<br>Lager |   | Takım Ölçüleri (mm)<br>Dimension (mm)<br>Abmessung (mm) |    |     |    | Kesici Uç<br>Insert<br>Wendescheidplatte | Yedek Parçaları / Spare Parts / Ersatzteile |  |                             |   |                         |   |
|--|------------------------|---|---|----|-----|----|--|---|--|-----------------------------|---|-------------------------|---|
|  | R                      | L | HF=H  | B  | LF  | WF |  | Baskı Pabucu<br>Wedge Clamp<br>Spannpratze  | Pabuç Vidası<br>Clamp Screw<br>Klemmschraube | Altlık<br>Shim<br>Unterlage | Altlık Vidası<br>Shim Screw<br>Schraube für Unterlage | Segman<br>Ring<br>Feder | Anahtar<br>Allen Key<br>Innensechskantschlüssel |
|  |                        |   |   |    |     |    |  |   |  |                             |   |                         |   |
| CSSNR/L 2525 M1207C                                | ●                      | ● | 25  | 25 | 150 | 32 | SN.N 1207..                              | ACK-13                                      | AKV-11-M8x29                                 | AASN-3-0004                 | AAV-02-M5x12  | ACS-01                  | AAL-05-4  |
| 3232 P1207C  | ●                      | ● | 32  | 32 | 170 | 40 |  |   |  |                             |   |                         |   |

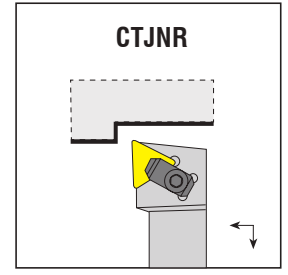
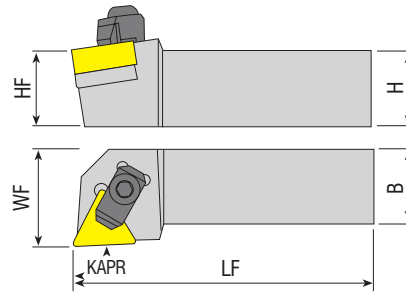

| Takım Kodu<br>Ordering Code<br>Bestell-Bezeichnung | Stok<br>Stock<br>Lager |   | Takım Ölçüleri (mm)<br>Dimension (mm)<br>Abmessung (mm) |    |     |    | Kesici Uç<br>Insert<br>Wendescheidplatte | Yedek Parçaları / Spare Parts / Ersatzteile |  |                             |   |                         |   |
|--|------------------------|---|---|----|-----|----|--|---|--|-----------------------------|---|-------------------------|---|
|  | R                      | L | HF=H  | B  | LF  | WF |  | Baskı Pabucu<br>Wedge Clamp<br>Spannpratze  | Pabuç Vidası<br>Clamp Screw<br>Klemmschraube | Altlık<br>Shim<br>Unterlage | Altlık Vidası<br>Shim Screw<br>Schraube für Unterlage | Segman<br>Ring<br>Feder | Anahtar<br>Allen Key<br>Innensechskantschlüssel |
|  |                        |   |   |    |     |    |  |   |  |                             |   |                         |   |
| CTJNR/L 2525 M1607C                                | ●                      | ● | 25  | 25 | 150 | 32 | TN.N 1607..                              | ACK-14                                      | AKV-11-M8x29                                 | AATN-2-0002                 | AAV-03-M5x12  | ACS-01                  | AAL-05-4  |
| 3232 P1607C  | ○                      | ○ | 32  | 32 | 170 | 40 |  |   |  |                             |   |                         |   |

R: Sağ / Right / Rechts L: Sol / Left / Links

● Stokta / In Stock / Auf Lager ○ Stokta Yok / Non Stock Item / Kein Lagerartikel, Lieferzeit auf Anfrage

Sipariş Örneği/Ordering Example/Bestellbeispiel

1 ad./pcs./stück CSSNR 2525 M1207C

# S-SİSTEM

**S-SİSTEM DIŞ TORNA KATERLERİ**  
S-SYSTEM EXTERNAL TURNING TOOLHOLDERS  
S-SYSTEM AUSSEN - DREHHALTER

*konuşulan  
the spoken kalite...  
quality...*



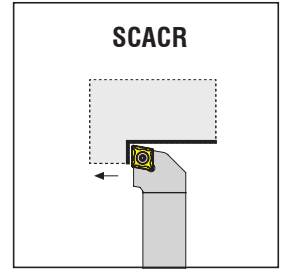
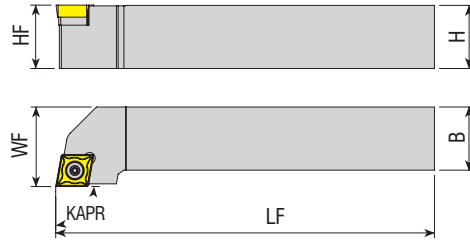

| Takım Kodu<br>Ordering Code<br>Bestell-Bezeichnung | Stok<br>Stock<br>Lager |   | Takım Ölçüleri (mm)<br>Dimension (mm)<br>Abmessung (mm) |    |     |    | Kesici Uç<br>Insert<br>Wendeschneidplatte | Yedek Parçaları / Spare Parts / Ersatzteile |                             |   |  |
|--|------------------------|---|---|----|-----|----|---|---|-----------------------------|---|--|
|  | R                      | L | HF=H  | B  | LF  | WF |   | Sıkma Vidası<br>Screw<br>Klemmschraube      | Altlık<br>Shim<br>Unterlage | Altlık Vidası<br>Shim Screw<br>Schraube für Unterlage | Tork Anahtar<br>Torx Key<br>Torx-Schlüssel |
|  |                        |   |   |    |     |    |   |   |                             |   |  |
| SCACR/L 0808 E06                                   | ●                      | ● | 08  | 08 | 70  | 10 | CCM. 0602..                               | 4008-M2.5x6                                 | -                           | -   | 82-T08                                     |
| 1010 E06   | ●                      | ● | 10  | 10 | 70  | 12 |   | 4015-M3.5x11                                | -                           | -   |  |
| 1212 F09   | ●                      | ● | 12  | 12 | 80  | 16 |   | 4015-M3.5x14                                | AACN-2-0001                 | AAV-06-M3.5x11  |  |
| 1616 H09   | ●                      | ● | 16  | 16 | 100 | 20 | CC.T 09T3..                               | 4015-M3.5x14                                | AACN-2-0001                 | AAV-06-M3.5x11  | 80-T15                                     |
| 2020 K09   | ●                      | ● | 20  | 20 | 125 | 25 |   |   |                             |   |  |
| 2020 K12   | ●                      | ● | 20  | 20 | 125 | 25 | CC.T 1204..                               | 1020-M4.5x16                                | AACN-2-0003                 | AAV-07-M4.5x13  | 80-T20                                     |
| 2525 M12   | ●                      | ● | 25  | 25 | 150 | 32 |   |   |                             |   |  |

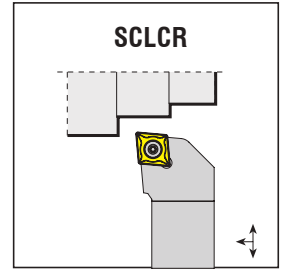
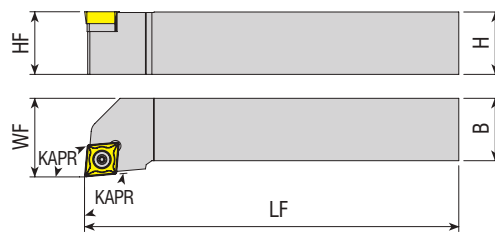

| Takım Kodu<br>Ordering Code<br>Bestell-Bezeichnung | Stok<br>Stock<br>Lager |   | Takım Ölçüleri (mm)<br>Dimension (mm)<br>Abmessung (mm) |    |     |    | Kesici Uç<br>Insert<br>Wendeschneidplatte | Yedek Parçaları / Spare Parts / Ersatzteile |                             |   |  |
|--|------------------------|---|---|----|-----|----|---|---|-----------------------------|---|--|
|  | R                      | L | HF=H  | B  | LF  | WF |   | Sıkma Vidası<br>Screw<br>Klemmschraube      | Altlık<br>Shim<br>Unterlage | Altlık Vidası<br>Shim Screw<br>Schraube für Unterlage | Tork Anahtar<br>Torx Key<br>Torx-Schlüssel |
|  |                        |   |   |    |     |    |   |   |                             |   |  |
| SCLCR/L 0808 E06                                   | ●                      | ● | 08  | 08 | 70  | 10 | CCM. 0602..                               | 4008-M2.5x6                                 | -                           | -   | 82-T08                                     |
| 1010 E06   | ●                      | ○ | 10  | 10 | 70  | 12 |   | 4015-M3.5x9                                 | -                           | -   |  |
| 1212 F06   | ●                      | ● | 12  | 12 | 80  | 16 |   | 4015-M3.5x11                                | -                           | -   |  |
| 1010 E09   | ●                      | ● | 10  | 10 | 70  | 12 | CC.T 09T3..                               | 4015-M3.5x14                                | AACN-2-0001                 | AAV-06-M3.5x11  | 80-T15                                     |
| 1212 F09   | ●                      | ● | 12  | 12 | 80  | 16 |   |   |                             |   |  |
| 1616 H09   | ●                      | ● | 16  | 16 | 100 | 20 |   |   |                             |   |  |
| 2020 K09   | ●                      | ● | 20  | 20 | 125 | 25 | CC.T 1204..                               | 1020-M5x11                                  | AACN-2-0003                 | AAV-07-M4.5x13  | 80-T20                                     |
| 2525 M09   | ●                      | ● | 25  | 25 | 150 | 32 |   |   |                             |   |  |
| 1616 H12   | ●                      | ○ | 16  | 16 | 100 | 20 | CC.T 1204..                               | 1020-M4.5x16                                | AACN-2-0003                 | AAV-07-M4.5x13  | 80-T20                                     |
| 2020 K12   | ●                      | ● | 20  | 20 | 125 | 25 |   |   |                             |   |  |
| 2525 M12   | ●                      | ● | 25  | 25 | 150 | 32 |   |   |                             |   |  |

R: Sağ / Right / Rechts L: Sol / Left / Links  
● Stokta / In Stock / Auf Lager ○ Stokta Yok / Non Stock Item / Kein Lagerartikel, Lieferzeit auf Anfrage

Sipariş Örneği/Ordering Example/Bestellbeispiel  
1 ad./pcs./stück SCACR 0808 E06

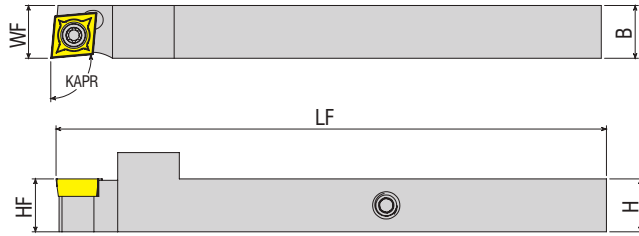
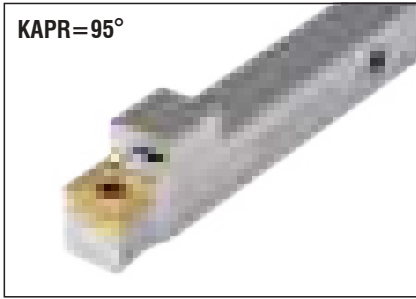

| Takım Kodu<br>Ordering Code<br>Bestell-Bezeichnung | Stok<br>Stock<br>Lager |   | Takım Ölçüleri (mm)<br>Dimension (mm)<br>Abmessung (mm) |    |     |    | Kesici Uç<br>Insert<br>Wendeschneidplatte | Yedek Parçaları / Spare Parts / Ersatzteile |                            |  |  |   |  |
|--|------------------------|---|---|----|-----|----|---|---|----------------------------|--|--|---|--|
|  | R                      | L | HF=H  | B  | LF  | WF |   | Sıkma Vidası<br>Screw<br>Klemmschraube      | Altık<br>Shim<br>Unterlage | Altık Vidası<br>Shim Screw<br>Schraube für Unterlage | Sızdırmaz Vida<br>Threaded Pin<br>Gewindestift | Anahtar<br>Allen Key<br>Innensechskantschlüssel | Tork Anahtar<br>Torx Key<br>Torx-Schlüssel |
|  | ●                      | ○ |   |    |     |    |   |   |                            |  |  |   |  |
| SCLCR/L 1212 K09-SHP                               | ●                      | ○ | 12  | 12 | 125 | 12 | CC.T 09T3..                               | 4015-M3.5x11                                | -                          | -  | 2703-M6X4                                      | AAL-03-3  | 80-T15                                     |
| 1616 K09-SHP                                       | ●                      | ○ | 16  | 16 | 125 | 16 |   |   |                            |  | 2704-M8X1X5                                    | AAL-05-4  |  |

ISO Ucuna Uygunur. / Compatible with ISO Insert. / Kompatibel mit ISO Wendeplatten.

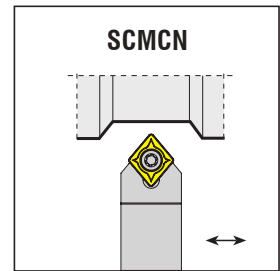
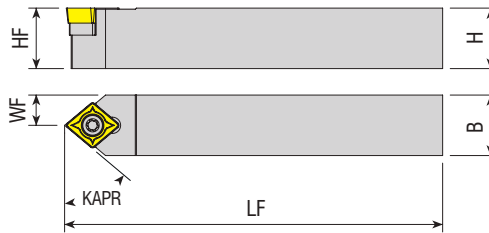

| Takım Kodu<br>Ordering Code<br>Bestell-Bezeichnung | Stok<br>Stock<br>Lager |   | Takım Ölçüleri (mm)<br>Dimension (mm)<br>Abmessung (mm) |    |     |      | Kesici Uç<br>Insert<br>Wendeschneidplatte | Yedek Parçaları / Spare Parts / Ersatzteile |                            |  |  |              |
|--|------------------------|---|---|----|-----|------|---|---|----------------------------|--|--|--------------|
|  |                        |   | HF=H  | B  | LF  | WF   |   | Sıkma Vidası<br>Screw<br>Klemmschraube      | Altık<br>Shim<br>Unterlage | Altık Vidası<br>Shim Screw<br>Schraube für Unterlage | Tork Anahtar<br>Torx Key<br>Torx-Schlüssel |              |
|  | ●                      | ○ |   |    |     |      |   |   |                            |  |  |              |
| SCMCN 0808 E06                                     | ●                      |   | 08  | 08 | 70  | 04   | CCM. 0602..                               | 4008-M2.5x6                                 | -                          | -  | 82-T08                                     |              |
| 1010 E06   | ●                      |   | 10  | 10 | 70  | 05   |   |   |                            |  |  |              |
| 1212 F06   | ●                      |   | 12  | 12 | 80  | 06   |   |   |                            |  |  |              |
| 1212 F09   | ●                      |   | 12  | 12 | 80  | 06   | CC.T 09T3..                               | 4015-M3.5x11                                | -                          | -  | 80-T15                                     |              |
| 1616 H09   | ●                      |   | 16  | 16 | 100 | 08   |   |   |                            |  |  | 4015-M3.5x14 |
| 2020 K12   | ●                      |   | 20  | 20 | 125 | 10   | CC.T 1204..                               | 1020-M4.5x16                                | AACN-2-0003                | AAV-07-M4.5x13                                       | 80-T20                                     |              |
| 2525 M12   | ●                      |   | 25  | 25 | 150 | 12.5 |   |   |                            |  |  |              |

R: Sağ / Right / Rechts L: Sol / Left / Links

● Stokta / In Stock / Auf Lager ○ Stokta Yok / Non Stock Item / Kein Lagerartikel, Lieferzeit auf Anfrage

Sipariş Örneği/Ordering Example/Bestellbeispiel  
1 ad./pcs./stück SCLCR/L 1212 K09-SHP

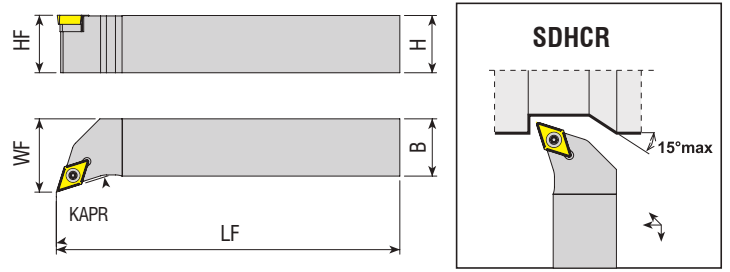
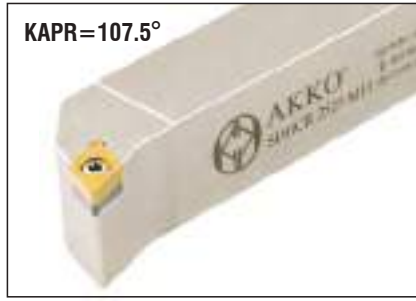

| Takım Kodu<br>Ordering Code<br>Bestell-Bezeichnung | Stok<br>Stock<br>Lager |   | Takım Ölçüleri (mm)<br>Dimension (mm)<br>Abmessung (mm) |    |     |    | Kesici Uç<br>Insert<br>Wendeschneidplatte | Yedek Parçaları / Spare Parts / Ersatzteile |                            |  |  |  |
|--|------------------------|---|---|----|-----|----|---|---|----------------------------|--|--|--|
|  | R                      | L | HF=H  | B  | LF  | WF |   | Sıkma Vidası<br>Screw<br>Klemmschraube      | Altık<br>Shim<br>Unterlage | Altık Vidası<br>Shim Screw<br>Schraube für Unterlage | Tork Anahtar<br>Torx Key<br>Torx-Schlüssel |  |
|  |                        |   |   |    |     |    |   |   |                            |  |  |  |
| SDHCR/L 0808 E07                                   | ●                      | ● | 08  | 08 | 70  | 11 | DC.T 0702..                               | 4008-M2.5x6                                 | -                          | -  | 82-T08                                     |  |
| 1010 E07   | ●                      | ● | 10  | 10 | 70  | 12 |   |   |                            |  |  |  |
| 1212 F07   | ●                      | ● | 12  | 12 | 80  | 16 |   |   |                            |  |  |  |
| 1616 H07   | ●                      | ● | 16  | 16 | 100 | 20 |   |   |                            |  |  |  |
| 1616 H11   | ●                      | ● | 16  | 16 | 100 | 20 | DC.T 11T3..                               | 4015-M3.5x14                                | AADN-2-0001                | AAV-06-M3.5x11                                       | 80-T15                                     |  |
| 2020 K11   | ●                      | ● | 20  | 20 | 125 | 25 |   |   |                            |  |  |  |
| 2525 M11   | ●                      | ● | 25  | 25 | 150 | 32 |   |   |                            |  |  |  |
| 3232 P11   | ●                      | ● | 32  | 32 | 170 | 40 |   |   |                            |  |  |  |

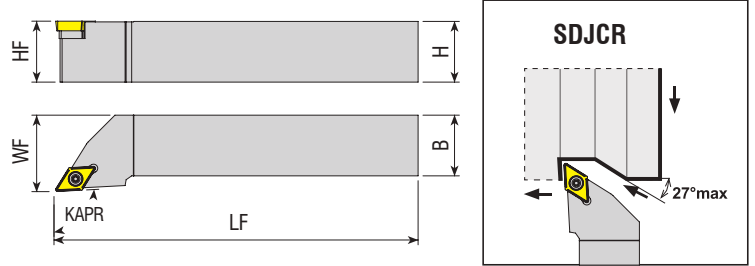

| Takım Kodu<br>Ordering Code<br>Bestell-Bezeichnung | Stok<br>Stock<br>Lager |   | Takım Ölçüleri (mm)<br>Dimension (mm)<br>Abmessung (mm) |    |     |    | Kesici Uç<br>Insert<br>Wendeschneidplatte | Yedek Parçaları / Spare Parts / Ersatzteile |                            |  |  |  |
|--|------------------------|---|---|----|-----|----|---|---|----------------------------|--|--|--|
|  | R                      | L | HF=H  | B  | LF  | WF |   | Sıkma Vidası<br>Screw<br>Klemmschraube      | Altık<br>Shim<br>Unterlage | Altık Vidası<br>Shim Screw<br>Schraube für Unterlage | Tork Anahtar<br>Torx Key<br>Torx-Schlüssel |  |
|  |                        |   |   |    |     |    |   |   |                            |  |  |  |
| SDJCR/L 0808 E07                                   | ●                      | ● | 08  | 08 | 70  | 10 | DC.T 0702..                               | 4008-M2.5x6                                 | -                          | -  | 82-T08                                     |  |
| 1010 E07   | ●                      | ● | 10  | 10 | 70  | 12 |   |   |                            |  |  |  |
| 1212 F07   | ●                      | ● | 12  | 12 | 80  | 16 |   |   |                            |  |  |  |
| 1616 H07   | ●                      | ● | 16  | 16 | 100 | 20 |   |   |                            |  |  |  |
| <b>new</b> 1212 F11                                | ●                      | ● | 12  | 12 | 80  | 16 | DC.T 11T3..                               | 4015-M3.5x14                                | AADN-2-0001                | AAV-06-M3.5x11                                       | 80-T15                                     |  |
| 1616 H11   | ●                      | ● | 16  | 16 | 100 | 20 |   |   |                            |  |  |  |
| 2020 K11   | ●                      | ● | 20  | 20 | 125 | 25 |   |   |                            |  |  |  |
| 2525 M11   | ●                      | ● | 25  | 25 | 150 | 32 |   |   |                            |  |  |  |
| 3232 P11   | ●                      | ● | 32  | 32 | 170 | 40 |   |   |                            |  |  |  |

R: Sağ / Right / Rechts L: Sol / Left / Links

● Stokta / In Stock / Auf Lager ○ Stokta Yok / Non Stock Item / Kein Lagerartikel, Lieferzeit auf Anfrage

Sipariş Örneği/Ordering Example/Bestellbeispiel  
1 ad./pcs./stück SDHCR 0808 E07



KAPR=93°

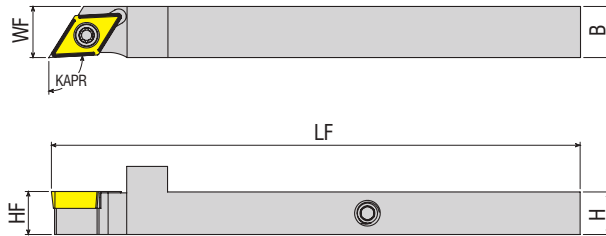
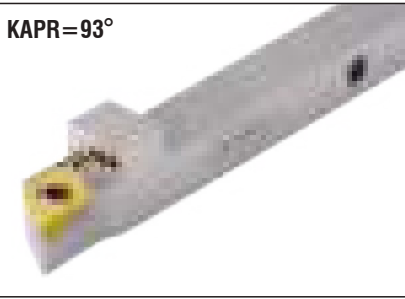

| Takım Kodu<br>Ordering Code<br>Bestell-Bezeichnung | Stok<br>Stock<br>Lager |   | Takım Ölçüleri (mm)<br>Dimension (mm)<br>Abmessung (mm) |    |     |    | Kesici Uç<br>Insert<br>Wendeschneidplatte | Yedek Parçaları / Spare Parts / Ersatzteile |                             |   |  |   |  |
|--|------------------------|---|---|----|-----|----|---|---|-----------------------------|---|--|---|--|
|  | R                      | L | HF=H  | B  | LF  | WF |   | Sıkma Vidası<br>Screw<br>Klemmschraube      | Altlık<br>Shim<br>Unterlage | Altlık Vidası<br>Shim Screw<br>Schraube für Unterlage | Sızdırmaz Vida<br>Threaded Pin<br>Gewindestift | Anahtar<br>Allen Key<br>Inmenschenschlüssel | Tork Anahtar<br>Torx Key<br>Torx-Schlüssel |
|  |                        |   |   |    |     |    |   |   |                             |   |  |   |  |
| SDJCR/L 0810 G07-SHP                               | ●                      | ○ | 8   | 10 | 90  | 10 | DC.T 0702..                               | 4008-M2.5x6                                 |                             |   |  |   | 82-T08                                     |
| 1010 K07-SHP                                       | ●                      | ○ | 10  | 10 | 125 | 10 |   |   |                             |   |  |   |  |
| 1012 K11-SHP                                       | ●                      | ○ | 10  | 12 | 125 | 12 | DC.T 11T3..                               | 4015-M3.5x14                                | -                           | -   | 2703-M6X4                                      | AAL-03-3                                    | 80-T15                                     |
| 1212 K11-SHP                                       | ●                      | ○ | 12  | 12 | 125 | 12 |   |   |                             |   | 2704-M8X1X5                                    | AAL-05-4                                    |  |
| 1616 K11-SHP                                       | ●                      | ○ | 16  | 16 | 125 | 16 |   |   |                             |   |  |   |  |

ISO Ucuna Uygun. / Compatible with ISO Insert. / Kompatibel mit ISO Wendepatten.

KAPR=62.5°

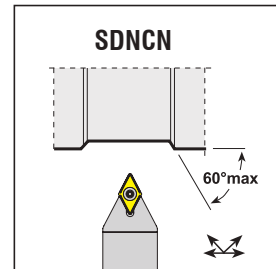
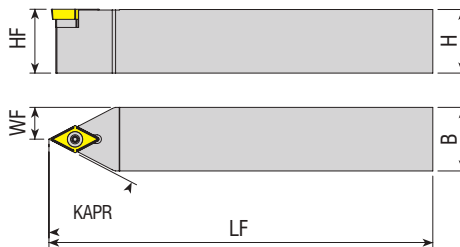

| Takım Kodu<br>Ordering Code<br>Bestell-Bezeichnung | Stok<br>Stock<br>Lager |  | Takım Ölçüleri (mm)<br>Dimension (mm)<br>Abmessung (mm) |    |     |      | Kesici Uç<br>Insert<br>Wendeschneidplatte | Yedek Parçaları / Spare Parts / Ersatzteile |                             |   |  |        |
|--|------------------------|--|---|----|-----|------|---|---|-----------------------------|---|--|--------|
|  |                        |  | HF=H  | B  | LF  | WF   |   | Sıkma Vidası<br>Screw<br>Klemmschraube      | Altlık<br>Shim<br>Unterlage | Altlık Vidası<br>Shim Screw<br>Schraube für Unterlage | Tork Anahtar<br>Torx Key<br>Torx-Schlüssel |        |
|  |                        |  |   |    |     |      |   |   |                             |   |  |        |
| SDNCRN 0808 E07                                    | ●                      |  | 08  | 08 | 70  | 4    | DC.T 0702..                               | 4008-M2.5x6                                 | -                           | -   |  | 82-T08 |
| 1010 E07   | ●                      |  | 10  | 10 | 70  | 5    |   |   |                             |   |  |        |
| 1212 F07   | ●                      |  | 12  | 12 | 80  | 6    |   |   |                             |   |  |        |
| 1616 H07   | ●                      |  | 16  | 16 | 100 | 8    |   |   |                             |   |  |        |
| 1616 H11   | ●                      |  | 16  | 16 | 100 | 8    | DC.T 11T3..                               | 4015-M3.5x14                                | AADN-2-0001                 | AAV-06-M3.5x11  | 80-T15                                     |        |
| 2020 K11   | ●                      |  | 20  | 20 | 125 | 10   |   |   |                             |   |  |        |
| 2525 M11   | ●                      |  | 25  | 25 | 150 | 12.5 |   |   |                             |   |  |        |
| 3232 P11   | ●                      |  | 32  | 32 | 170 | 16   |   |   |                             |   |  |        |

R: Sağ / Right / Rechts L: Sol / Left / Links

● Stokta / In Stock / Auf Lager ○ Stokta Yok / Non Stock Item / Kein Lagerartikel, Lieferzeit auf Anfrage

Sipariş Örneği/Ordering Example/Bestellbeispiel  
1 ad./pcs./stück SDJCR/L 0810 G07-SHP

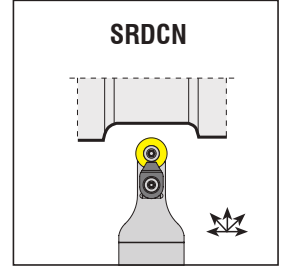
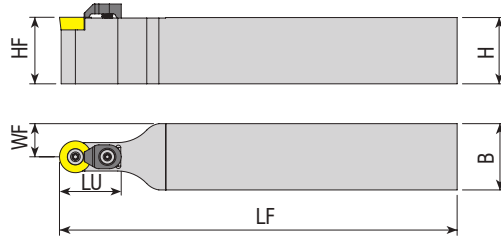

Yedek Parçaları / Spare Parts / Ersatzteile

| Takım Kodu<br>Ordering Code<br>Bestell-Bezeichnung | Stok<br>Stock<br>Lager | Takım Ölçüleri (mm)<br>Dimension (mm)<br>Abmessung (mm) |    |     |    |      | Kesici Uç<br>Insert<br>Wendeschneidplatte | Sıkma Vidası<br>Screw<br>Klemmschraube | Altlık<br>Shim<br>Unterlage | Altlık Vidası<br>Shim Screw<br>Schraube für Unterlage | Baskı Parçası<br>Wedge Clamp<br>Spannpratze | Baskı Vidası<br>Clamp Screw<br>Klemmschraube | Tork Anahtar<br>Torx Key<br>Torx-Schlüssel |
|--|------------------------|---|----|-----|----|------|---|--|-----------------------------|---|---|--|--|
|  |                        | HF=H  | B  | LF  | LU | WF   |   |  |                             |   |   |  |  |
| SRDCN 1616 H06                                     | ●                      | 16  | 16 | 100 | 15 | 8    |   |  |                             |   |   |  |  |
| 2020 K06   | ●                      | 20  | 20 | 125 | 17 | 10   | RC.T 0602..                               | 3008-M2.5x6                            | -                           | -   | -   | -  |  |
| 2525 M06   | ●                      | 25  | 25 | 150 | 17 | 12.5 |   |  |                             |   |   |  | 82-T08                                     |
| 1616 H08C  | ●                      | 16  | 16 | 100 | 15 | 8    |   |  |                             |   |   |  |  |
| 2020 K08C  | ●                      | 20  | 20 | 125 | 20 | 10   | RC.T 0803..                               | 3008-M3x8                              | -                           | -   |   |  |  |
| 2525 M08C  | ●                      | 25  | 25 | 150 | 20 | 12.5 |   |  |                             |   |   |  |  |
| 1616 H10C  | ●                      | 16  | 16 | 100 | 20 | 8    |   |  |                             |   | ACK-15                                      | 4015-M3.5x11                                 |  |
| 2020 K10C  | ●                      | 20  | 20 | 125 | 20 | 10   |   |  |                             |   |   |  |  |
| 2525 M10C  | ●                      | 25  | 25 | 150 | 20 | 12.5 | RC.T 10T3..                               | 4015-M3.5x11                           | -                           | -   |   |  |  |
| 3232 P10C  | ●                      | 32  | 32 | 170 | 20 | 16   |   |  |                             |   |   |  |  |
| 2020 K12C  | ●                      | 20  | 20 | 125 | 22 | 10   |   |  |                             |   |   |  |  |
| 2525 M12C  | ●                      | 25  | 25 | 150 | 22 | 12.5 | RC.T 1204..                               | 4015-M3.5x11                           | -                           | -   |   |  |  |
| 3232 P12C  | ●                      | 32  | 32 | 170 | 22 | 16   |   |  |                             |   |   |  |  |
| 2525 M16C  | ●                      | 25  | 25 | 150 | 32 | 12.5 |   |  |                             |   | ACK-05                                      | 4015-M4x11                                   |  |
| 3232 P16C  | ●                      | 32  | 32 | 170 | 35 | 16   | RC.T 1605..                               | 1020-M5x11                             | -                           | -   |   |  |  |
| 2525 M20C  | ●                      | 25  | 25 | 150 | 32 | 12.5 |   |  |                             |   |   |  |  |
| 3232 P20C  | ●                      | 32  | 32 | 170 | 40 | 16   | RC.T 2006..                               | 1420-M6x16                             | -                           | -   |   |  |  |
| 3232 P25C  | ●                      | 32  | 32 | 170 | 40 | 16   | RC.T 2507..                               | 1520-M6x16                             | -                           | -   | ACK-09                                      | AAV-05-M6x15                                 | 80-T20                                     |
| 3232 P32C  | ●                      | 32  | 32 | 170 | 45 | 16   | RC.T 3209..                               | 1904-M8x1x20                           | -                           | -   |   |  | AAL-05-4                                   |

R: Sağ / Right / Rechts L: Sol / Left / Links

● Stokta / In Stock / Auf Lager ○ Stokta Yok / Non Stock Item / Kein Lagerartikel, Lieferzeit auf Anfrage

Sipariş Örneği/Ordering Example/Bestellbeispiel

1 ad./pcs./stück SRDCN 1616 H06





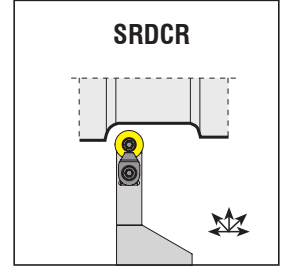
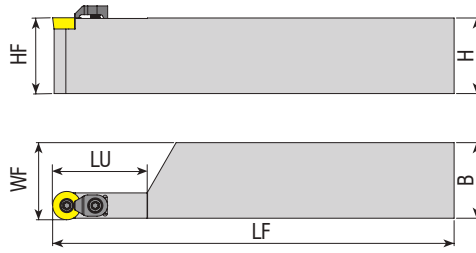

**Takım Kodu**  
**Ordering Code**  
**Bestell-Bezeichnung**

| Stok<br>Stock<br>Lager | Takım Ölçüleri (mm)<br>Dimension (mm)<br>Abmessung (mm) |   |      |    |     |    | Kesici Uç<br>Insert<br>Wendeschneidplatte | Yedek Parçaları / Spare Parts / Ersatzteile |  |                             |   |   |  |  |
|------------------------|---|---|------|----|-----|----|---|---|--|-----------------------------|---|---|--|--|
|                        | R   | L | HF=H | B  | LF  | LU |   | WF  | Sıkma Vidası<br>Screw<br>Klemmschraube | Altlık<br>Shim<br>Unterlage | Altlık Vidası<br>Shim Screw<br>Schraube für Unterlage | Baskı Parçası<br>Wedge Clamp<br>Spannpratze | Baskı Vidası<br>Clamp Screw<br>Klemmschraube | Tork Anahtar<br>Torx Key<br>Torx-Schlüssel |
| SRDCR/L 3232 T06       | ●   | ● | 32   | 32 | 300 | 20 | 32.35                                     | RC.T 0602..                                 | 3008-M2.5x6                            | -                           | -   | -   | -  | 82-T08                                     |
| 3232 P12C              | ●   | ● | 32   | 32 | 170 | 40 | 32.65                                     | RC.T 1204..                                 | 4015-M3.5x11                           |                             |   | ACK-05                                      | 4015-M4x11                                   | 80-T15                                     |

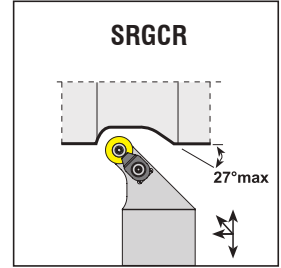
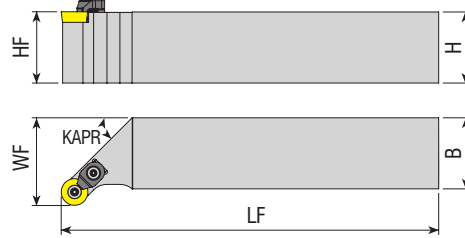

**Takım Kodu**  
**Ordering Code**  
**Bestell-Bezeichnung**

| Stok<br>Stock<br>Lager | Takım Ölçüleri (mm)<br>Dimension (mm)<br>Abmessung (mm) |   |      |    |     |    | Kesici Uç<br>Insert<br>Wendeschneidplatte | Yedek Parçaları / Spare Parts / Ersatzteile |                             |   |   |  |  |  |
|------------------------|---|---|------|----|-----|----|---|---|-----------------------------|---|---|--|--|--|
|                        | R   | L | HF=H | B  | LF  | WF |   | Sıkma Vidası<br>Screw<br>Klemmschraube      | Altlık<br>Shim<br>Unterlage | Altlık Vidası<br>Shim Screw<br>Schraube für Unterlage | Baskı Parçası<br>Wedge Clamp<br>Spannpratze | Baskı Vidası<br>Clamp Screw<br>Klemmschraube | Tork Anahtar<br>Torx Key<br>Torx-Schlüssel |  |
| SRGCR/L 1616 H06       | ●   | ● | 16   | 16 | 100 | 20 | RC.T 0602..                               | 3008-M2.5x6                                 | -                           | -   | -   | -  | 82-T08                                     |  |
| 2020 K06               | ●   | ● | 20   | 20 | 125 | 25 |   |   |                             |   |   |  |  |  |
| 1616 H08C              | ●   | ● | 16   | 16 | 100 | 20 | RC.T 0803..                               | 3008-M3x8                                   | -                           | -   | ACK-15                                      | 4015-M3.5x11                                 | 80-T15                                     |  |
| 2020 K08C              | ●   | ● | 20   | 20 | 125 | 25 |   |   |                             |   |   |  |  |  |
| 2525 M08C              | ●   | ● | 25   | 25 | 150 | 32 | RC.T 10T3..                               | 4015-M3.5x11                                | -                           | -   | ACK-05                                      | 4015-M4x11                                   | 80-T15                                     |  |
| 1616 H10C              | ●   | ● | 16   | 16 | 100 | 20 |   |   |                             |   |   |  |  |  |
| 2020 K10C              | ●   | ● | 20   | 20 | 125 | 25 |   |   |                             |   |   |  |  |  |
| 2525 M10C              | ●   | ● | 25   | 25 | 150 | 32 |   |   |                             |   |   |  |  |  |
| 3232 P10C              | ●   | ● | 32   | 32 | 170 | 40 | RC.T 1204..                               | 4015-M3.5x11                                | -                           | -   | ACK-05                                      | 4015-M4x11                                   | 80-T15                                     |  |
| 2020 K12C              | ●   | ● | 20   | 20 | 125 | 25 |   |   |                             |   |   |  |  |  |
| 2525 M12C              | ●   | ● | 25   | 25 | 150 | 32 |   |   |                             |   |   |  |  |  |
| 3232 P12C              | ●   | ● | 32   | 32 | 170 | 40 |   |   |                             |   |   |  |  |  |

R: Sağ / Right / Rechts L: Sol / Left / Links

● Stokta / In Stock / Auf Lager ○ Stokta Yok / Non Stock Item / Kein Lagerartikel, Lieferzeit auf Anfrage

Sipariş Örneği/Ordering Example/Bestellbeispiel

1 ad./pcs./stück SRDCR 3232 T06

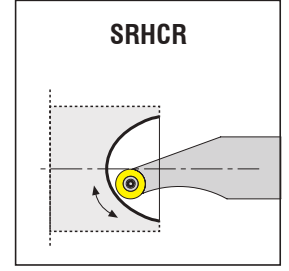
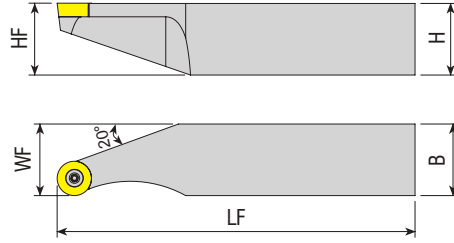

| Takım Kodu<br>Ordering Code<br>Bestell-Bezeichnung | Stok<br>Stock<br>Lager |   | Takım Ölçüleri (mm)<br>Dimension (mm)<br>Abmessung (mm) |    |     |    |       | Kesici Uç<br>Insert<br>Wendeschneidplatte | Yedek Parçaları / Spare Parts / Ersatzteile |                             |   |  |  |
|--|------------------------|---|---|----|-----|----|-------|---|---|-----------------------------|---|--|--|
|  | R                      | L | HF=H  | B  | LF  | WF | MIN R |   | Sıkma Vidası<br>Screw<br>Klemmschraube      | Altlık<br>Shim<br>Unterlage | Altlık Vidası<br>Shim Screw<br>Schraube für Unterlage | Tork Anahtar<br>Torx Key<br>Torx-Schlüssel |  |
| SRHCR/L 2525 K06                                   | ●                      | ○ | 25  | 25 | 125 | 25 | 32.5  |   |   |                             |   |  |  |
| 2525 K08   | ●                      | ● | 25  | 25 | 125 | 25 | 32.5  | RC.T 0602..                               | 3008-M2.5x6                                 | -                           | -   | 82-T08                                     |  |
| 2525 K10   | ●                      | ● | 25  | 25 | 125 | 25 | 36    | RC.T 0803..                               | 3008-M3x8                                   | -                           | -   |  |  |
| 2525 K12   | ●                      | ● | 25  | 25 | 125 | 25 | 40    | RC.T 10T3..                               | 4015-M3.5x11                                | -                           | -   | 80-T15                                     |  |
| 2525 K16   | ●                      | ● | 25  | 25 | 125 | 25 | 47.5  | RC.T 1204..                               | 1020-M5x11                                  | -                           | -   | 80-T20                                     |  |

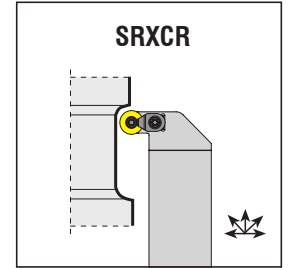
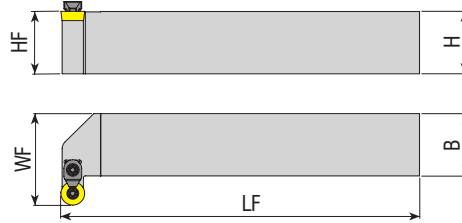

| Takım Kodu<br>Ordering Code<br>Bestell-Bezeichnung | Stok<br>Stock<br>Lager |   | Takım Ölçüleri (mm)<br>Dimension (mm)<br>Abmessung (mm) |    |     |    | Kesici Uç<br>Insert<br>Wendeschneidplatte | Sıkma Vidası<br>Screw<br>Klemmschraube | Altlık<br>Shim<br>Unterlage | Altlık Vidası<br>Shim Screw<br>Schraube für Unterlage | Baskı Parçası<br>Wedge Clamp<br>Spannpratze | Baskı Vidası<br>Clamp Screw<br>Klemmschraube | Tork Anahtar<br>Torx Key<br>Torx-Schlüssel |
|--|------------------------|---|---|----|-----|----|---|--|-----------------------------|---|---|--|--|
|  | R                      | L | HF=H  | B  | LF  | WF |   |  |                             |   |   |  |  |
| SRXCR/L 3232 X08C                                  | ●                      | ● | 32  | 32 | 220 | 47 |   |  |                             |   |   |  |  |
| 3232 X10C  | ●                      | ● | 32  | 32 | 220 | 47 | RC.T 0803..                               | 3008-M3x8                              | -                           | -   | ACK-15                                      | 4015-M3.5x11                                 | 82-T08                                     |
| 3232 X12C  | ●                      | ● | 32  | 32 | 220 | 47 | RC.T 10T3..                               | 4015-M3.5x11                           | -                           | -   | ACK-05                                      | 4015-M4x11                                   | 80-T15                                     |
|  |                        |   |   |    |     |    | RC.T 1204..                               |  |                             |   |   |  |  |

R: Sağ / Right / Rechts L: Sol / Left / Links

● Stokta / In Stock / Auf Lager ○ Stokta Yok / Non Stock Item / Kein Lagerartikel, Lieferzeit auf Anfrage

Sipariş Örneği/Ordering Example/Bestellbeispiel

1 ad./pcs./stück SRHCR 2525 K06

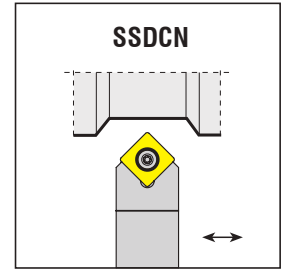
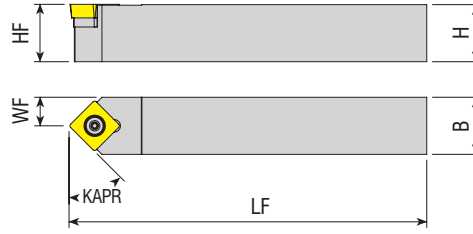

**Takım Kodu**  
**Ordering Code**  
*Bestell-Bezeichnung*

| Stok<br>Stock<br>Lager | Takım Ölçüleri (mm)<br>Dimension (mm)<br>Abmessung (mm) |    |    |     | Kesici Uç<br>Insert<br>Wendeschneidplatte | Yedek Parçaları / Spare Parts / Ersatzteile |                             |   |  |        |
|------------------------|---|----|----|-----|---|---|-----------------------------|---|--|--------|
|                        | HF=H  | B  | LF | WF  |   | Sıkma Vidası<br>Screw<br>Klemmschraube      | Altlık<br>Shim<br>Unterlage | Altlık Vidası<br>Shim Screw<br>Schraube für Unterlage | Tork Anahtar<br>Torx Key<br>Torx-Schlüssel |        |
|                        |   |    |    |     |   |   |                             |   |  |        |
| <b>SSDCN 1212 F09</b>  | ●   | 12 | 12 | 80  | 6   | 4015-M3.5x11                                | -                           | -   |  |        |
| <b>1616 H09</b>        | ●   | 16 | 16 | 100 | 8   | <b>SC.T 09T3..</b>                          | 4015-M3.5x14                | AASN-2-0001   | AAV-06-M3.5x11                             | 80-T15 |
| <b>2020 K09</b>        | ●   | 20 | 20 | 125 | 10  |   |                             |   |  |        |
| <b>1616 H12</b>        | ●   | 16 | 16 | 100 | 8   | <b>SC.T 1204..</b>                          | 4020-M4.5x12                | AASN-2-0004   | AAV-10-M4.5x8                              | 80-T20 |
| <b>2020 K12</b>        | ●   | 20 | 20 | 125 | 10  |   |                             |   |  |        |
| <b>2525 M12</b>        | ●   | 25 | 25 | 150 | 12.5                                      |   |                             |   |  |        |

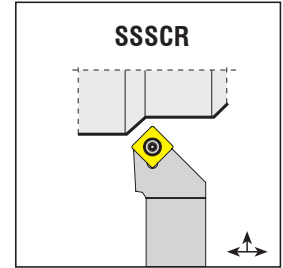
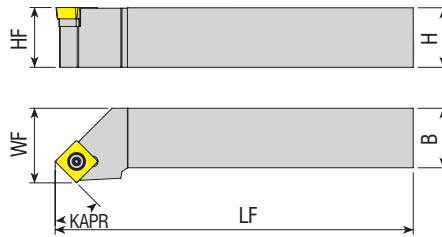

**Takım Kodu**  
**Ordering Code**  
*Bestell-Bezeichnung*

| Stok<br>Stock<br>Lager  | Takım Ölçüleri (mm)<br>Dimension (mm)<br>Abmessung (mm) |   |      |    | Kesici Uç<br>Insert<br>Wendeschneidplatte | Yedek Parçaları / Spare Parts / Ersatzteile |                    |  |                             |   |  |
|-------------------------|---|---|------|----|---|---|--------------------|--|-----------------------------|---|--|
|                         | R   | L | HF=H | B  |   | LF  | WF                 | Sıkma Vidası<br>Screw<br>Klemmschraube | Altlık<br>Shim<br>Unterlage | Altlık Vidası<br>Shim Screw<br>Schraube für Unterlage | Tork Anahtar<br>Torx Key<br>Torx-Schlüssel |
|                         |   |   |      |    |   |   |                    |  |                             |   |  |
| <b>SSSCR/L 1212 F09</b> | ●   | ● | 12   | 12 | 80  | 16  | 4015-M3.5x11       | -                                      | -                           |   |  |
| <b>1616 H09</b>         | ●   | ● | 16   | 16 | 100                                       | 20  | <b>SC.T 09T3..</b> | 4015-M3.5x14                           | AASN-2-0001                 | AAV-06-M3.5x11  | 80-T15                                     |
| <b>2020 K09</b>         | ●   | ● | 20   | 20 | 125                                       | 25  |                    |  |                             |   |  |
| <b>1616 H12</b>         | ●   | ● | 16   | 16 | 100                                       | 20  | <b>SC.T 1204..</b> | 4020-M4.5x12                           | AASN-2-0004                 | AAV-10-M4.5x8   | 80-T20                                     |
| <b>2020 K12</b>         | ●   | ● | 20   | 20 | 125                                       | 25  |                    |  |                             |   |  |
| <b>2525 M12</b>         | ●   | ● | 25   | 25 | 150                                       | 32  |                    |  |                             |   |  |

R: Sağ / Right / Rechts L: Sol / Left / Links

● Stokta / In Stock / Auf Lager ○ Stokta Yok / Non Stock Item / Kein Lagerartikel, Lieferzeit auf Anfrage

Sipariş Örneği/Ordering Example/Bestellbeispiel

1 ad./pcs./stück SSDCN 1212 F09

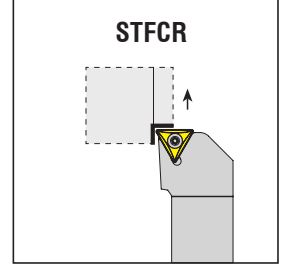
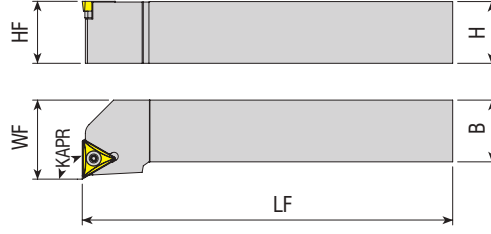

**Takım Kodu**  
**Ordering Code**  
*Bestell-Bezeichnung*

| Stok<br>Stock<br>Lager | Takım Ölçüleri (mm)<br>Dimension (mm)<br>Abmessung (mm) |   |      |   |    | Kesici Uç<br>Insert<br>Wendeschneidplatte | Sıkma Vidası<br>Screw<br>Klemmschraube | Altlık<br>Shim<br>Unterlage | Altlık Vidası<br>Shim Screw<br>Schraube für Unterlage | Tork Anahtar<br>Torx Key<br>Torx-Schlüssel |
|------------------------|---|---|------|---|----|---|--|-----------------------------|---|--|
|                        | R   | L | HF=H | B | LF |   |  |                             |   |  |
|                        |   |   |      |   |    |   |  |                             |   |  |
|                        |   |   |      |   |    | TC.T 1102..                               | 4008-M2.5x6                            | -                           | -   | 82-T08                                     |
|                        |   |   |      |   |    |   |  |                             |   |  |
|                        |   |   |      |   |    | TC.T 16T3..                               | 4015-M3.5x14                           | AATN-2-0001                 | AAV-06-M3.5x11  | 80-T15                                     |
|                        |   |   |      |   |    |   |  |                             |   |  |
|                        |   |   |      |   |    |   |  |                             |   |  |

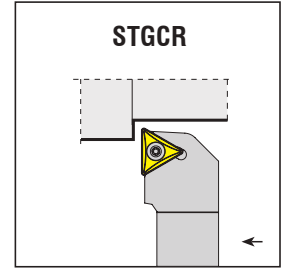
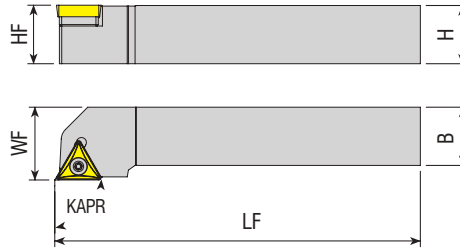

**Takım Kodu**  
**Ordering Code**  
*Bestell-Bezeichnung*

| Stok<br>Stock<br>Lager | Takım Ölçüleri (mm)<br>Dimension (mm)<br>Abmessung (mm) |   |      |   |    | Kesici Uç<br>Insert<br>Wendeschneidplatte | Sıkma Vidası<br>Screw<br>Klemmschraube | Altlık<br>Shim<br>Unterlage | Altlık Vidası<br>Shim Screw<br>Schraube für Unterlage | Tork Anahtar<br>Torx Key<br>Torx-Schlüssel |
|------------------------|---|---|------|---|----|---|--|-----------------------------|---|--|
|                        | R   | L | HF=H | B | LF |   |  |                             |   |  |
|                        |   |   |      |   |    |   |  |                             |   |  |
|                        |   |   |      |   |    | TC.T 1102..                               | 4008-M2.5x6                            | -                           | -   | 82-T08                                     |
|                        |   |   |      |   |    |   |  |                             |   |  |
|                        |   |   |      |   |    | TC.T 16T3..                               | 4015-M3.5x14                           | AATN-2-0001                 | AAV-06-M3.5x11  | 80-T15                                     |
|                        |   |   |      |   |    |   |  |                             |   |  |
|                        |   |   |      |   |    |   |  |                             |   |  |

R: Sağ / Right / Rechts L: Sol / Left / Links  
● Stokta / In Stock / Auf Lager ○ Stokta Yok / Non Stock Item / Kein Lagerartikel, Lieferzeit auf Anfrage

Sipariş Örneği/Ordering Example/Bestellbeispiel  
1 ad./pcs./stück STFGR 0808 E09

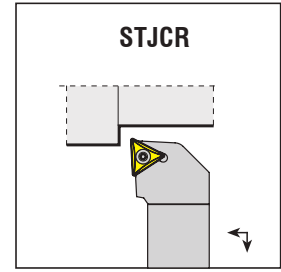
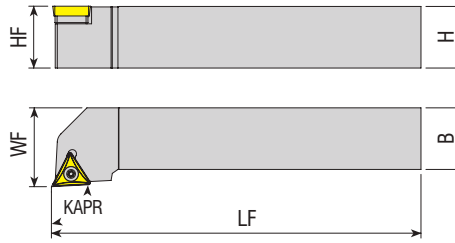

**Takım Kodu**  
**Ordering Code**  
*Bestell-Bezeichnung*

| Stok<br>Stock<br>Lager | Takım Ölçüleri (mm)<br>Dimension (mm)<br>Abmessung (mm) |   |      |    |     | Kesici Uç<br>Insert<br>Wendeschneidplatte | Yedek Parçaları / Spare Parts / Ersatzteile |  |                              |  |  |
|------------------------|---|---|------|----|-----|---|---|--|------------------------------|--|--|
|                        | R   | L | HF=H | B  | LF  |   | WF  | Sıkma Vidası<br>Screw<br>Klemmschraube | Altılık<br>Shim<br>Unterlage | Altılık Vidası<br>Shim Screw<br>Schraube für Unterlage | Tork Anahtar<br>Torx Key<br>Torx-Schlüssel |
| STJCR/L 0808 E09       | ●   | ● | 08   | 08 | 70  | 10  | TC.T 0902..                                 | 3007-M2.2x4.6                          | -                            | -  | 82-T07                                     |
| 1010 E09               | ●   | ● | 10   | 10 | 70  | 12  |   |  |                              |  |  |
| 1212 F11               | ●   | ● | 12   | 12 | 80  | 16  |   |  |                              |  |  |
| 1616 H11               | ●   | ● | 16   | 16 | 100 | 20  | TC.T 1102..                                 | 4008-M2.5x6                            | -                            | -  | 82-T08                                     |
| 1616 H16               | ●   | ● | 16   | 16 | 100 | 20  |   |  |                              |  |  |
| 2020 K16               | ●   | ● | 20   | 20 | 125 | 25  | TC.T 16T3..                                 | 4015-M3.5x14                           | AATN-2-0001                  | AAV-06-M3.5x11   | 80-T15                                     |
| 2525 M16               | ●   | ● | 25   | 25 | 150 | 32  |   |  |                              |  |  |
| 3232 P16               | ●   | ● | 32   | 32 | 170 | 40  |   |  |                              |  |  |

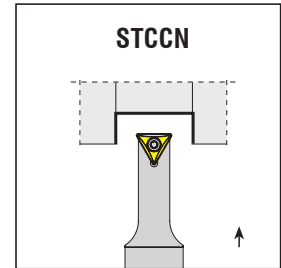
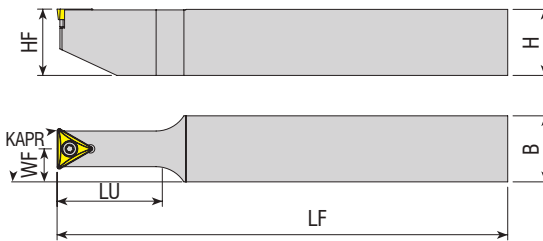

**Takım Kodu**  
**Ordering Code**  
*Bestell-Bezeichnung*

| Stok<br>Stock<br>Lager | Takım Ölçüleri (mm)<br>Dimension (mm)<br>Abmessung (mm) |    |    |     |      |  | Kesici Uç<br>Insert<br>Wendeschneidplatte | Yedek Parçaları / Spare Parts / Ersatzteile |  |  |        |
|------------------------|---|----|----|-----|------|--|---|---|--|--|--------|
|                        | HF=H  | B  | LF | WF  | LU   | Sıkma Vidası<br>Screw<br>Klemmschraube |   | Altılık<br>Shim<br>Unterlage                | Altılık Vidası<br>Shim Screw<br>Schraube für Unterlage | Tork Anahtar<br>Torx Key<br>Torx-Schlüssel |        |
| STCCN 2020 L11         | ●   | 20 | 20 | 140 | 10   | 50                                     | TC.T 1102..                               | 4008-M2.5x6                                 | -  | -  | 82-T08 |
| 1616 K16               | ●   | 16 | 16 | 125 | 8    | 24                                     |   |   |  |  |        |
| 2020 M16               | ●   | 20 | 20 | 150 | 10   | 30                                     | TC.T 16T3..                               | 4015-M3.5x14                                | AATN-2-0001  | AAV-06-M3.5x11                             | 80-T15 |
| 2525 P16               | ●   | 25 | 25 | 170 | 12.5 | 37.5                                   |   |   |  |  |        |
| 3232 R16               | ●   | 32 | 32 | 200 | 16   | 48                                     |   |   |  |  |        |
| 2525 P22               | ●   | 25 | 25 | 170 | 12.5 | 80                                     | TC.T 2204..                               | 4020-M4.5x12                                | -  | -  | 80-T20 |

R: Sağ / Right / Rechts L: Sol / Left / Links

● Stokta / In Stock / Auf Lager ○ Stokta Yok / Non Stock Item / Kein Lagerartikel, Lieferzeit auf Anfrage

Sipariş Örneği/Ordering Example/Bestellbeispiel

1 ad./pcs./stück STJCR 0808 E09

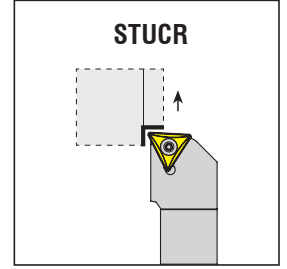
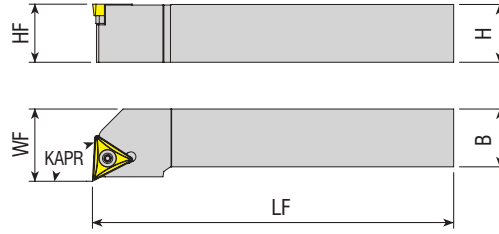

**Takım Kodu**  
**Ordering Code**  
*Bestell-Bezeichnung*

Stok  
Stock  
Lager

R L

Takım Ölçüleri (mm)  
Dimension (mm)  
Abmessung (mm)

HF=H B LF WF

Kesici Uç  
Insert  
Wendeschneidplatte

Sıkma Vidası  
Screw  
Klemmschraube

Altık  
Shim  
Unterlage

Altık Vidası  
Shim Screw  
Schraube für Unterlage

Tork Anahtar  
Torx Key  
Torx-Schlüssel

Yedek Parçaları / Spare Parts / Ersatzteile

|                         |   |   |    |    |     |    |                    |               |             |                |        |
|-------------------------|---|---|----|----|-----|----|--------------------|---------------|-------------|----------------|--------|
| <b>STUCR/L 0808 E09</b> | ● | ● | 08 | 08 | 70  | 10 | <b>TC.T 0902..</b> | 3007-M2.2x4.6 | -           | -              | 82-T07 |
| <b>1010 E09</b>         | ● | ● | 10 | 10 | 70  | 12 |                    |               |             |                |        |
| <b>1212 F11</b>         | ● | ● | 12 | 12 | 80  | 16 | <b>TC.T 1102..</b> | 4008-M2.5x6   | -           | -              | 82-T08 |
| <b>1616 H11</b>         | ● | ● | 16 | 16 | 100 | 20 |                    |               |             |                |        |
| <b>1616 H16</b>         | ○ | ○ | 16 | 16 | 100 | 20 | <b>TC.T 16T3..</b> | 4015-M3.5x14  | AATN-2-0001 | AAV-06-M3.5x11 | 80-T15 |
| <b>2020 K16</b>         | ● | ● | 20 | 20 | 125 | 25 |                    |               |             |                |        |
| <b>2525 M16</b>         | ● | ● | 25 | 25 | 150 | 32 |                    |               |             |                |        |
| <b>3232 P16</b>         | ● | ● | 32 | 32 | 170 | 40 |                    |               |             |                |        |

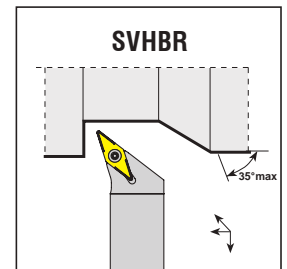
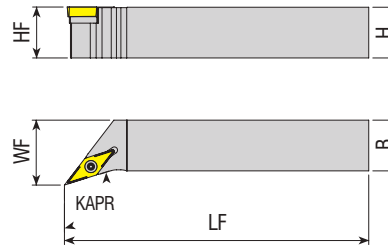
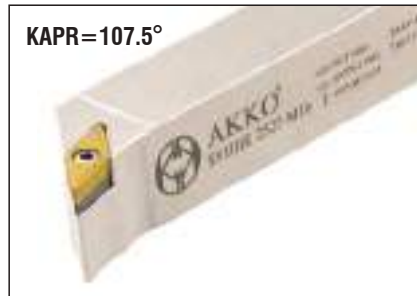

**Takım Kodu**  
**Ordering Code**  
*Bestell-Bezeichnung*

Stok  
Stock  
Lager

R L

Takım Ölçüleri (mm)  
Dimension (mm)  
Abmessung (mm)

HF=H B LF WF

Kesici Uç  
Insert  
Wendeschneidplatte

Sıkma Vidası  
Screw  
Klemmschraube

Altık  
Shim  
Unterlage

Altık Vidası  
Shim Screw  
Schraube für Unterlage

Tork Anahtar  
Torx Key  
Torx-Schlüssel

Yedek Parçaları / Spare Parts / Ersatzteile

|                         |   |   |    |    |     |    |                    |              |             |                |        |
|-------------------------|---|---|----|----|-----|----|--------------------|--------------|-------------|----------------|--------|
| <b>SVHBR/L 1212 F11</b> | ● | ● | 12 | 12 | 80  | 16 | <b>VB.T 1103..</b> | 4008-M2.5x6  | -           | -              | 82-T08 |
| <b>1616 H11</b>         | ● | ● | 16 | 16 | 100 | 20 |                    |              |             |                |        |
| <b>2020 K11</b>         | ● | ● | 20 | 20 | 125 | 25 | <b>VB.T 1604..</b> | 4015-M3.5x14 | AAVN-2-0002 | AAV-06-M3.5x11 | 80-T15 |
| <b>2020 K16</b>         | ● | ● | 20 | 20 | 125 | 25 |                    |              |             |                |        |
| <b>2525 M16</b>         | ● | ● | 25 | 25 | 150 | 32 |                    |              |             |                |        |
| <b>3232 P16</b>         | ● | ● | 32 | 32 | 170 | 40 |                    |              |             |                |        |

R: Sağ / Right / Rechts L: Sol / Left / Links

● Stokta / In Stock / Auf Lager ○ Stokta Yok / Non Stock Item / Kein Lagerartikel, Lieferzeit auf Anfrage

Sipariş Örneği / Ordering Example / Bestellbeispiel

1 ad./pcs./stück STUCR 0808 E09

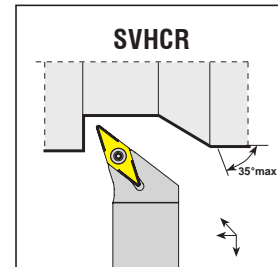
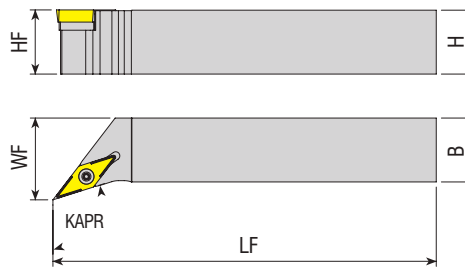

**Takım Kodu**  
**Ordering Code**  
*Bestell-Bezeichnung*

| R | L | Takım Ölçüleri (mm)<br>Dimension (mm)<br>Abmessung (mm) |    |     |    |
|---|---|---|----|-----|----|
|   |   | HF=H  | B  | LF  | WF |
| ● | ● | 12  | 12 | 80  | 16 |
| ● | ● | 16  | 16 | 100 | 20 |
| ● | ● | 20  | 20 | 125 | 25 |
| ● | ● | 20  | 20 | 125 | 25 |
| ● | ● | 25  | 25 | 150 | 32 |
| ● | ● | 32  | 32 | 170 | 40 |

| Kesici Uç<br>Insert<br>Wendeschneidplatte | Yedek Parçaları / Spare Parts / Ersatzteile |                             |   |  |
|---|---|-----------------------------|---|--|
|   | Sıkma Vidası<br>Screw<br>Klemmschraube      | Altlık<br>Shim<br>Unterlage | Altlık Vidası<br>Shim Screw<br>Schraube für Unterlage | Tork Anahtar<br>Torx Key<br>Torx-Schlüssel |
|   |   |                             |   |  |
| <b>VC.T 1103..</b>                        | 4008-M2.5x6                                 | -                           | -   | 82-T08                                     |
| <b>VC.T 1604..</b>                        | 4015-M3.5x14                                | AAVN-2-0002                 | AAV-06-M3.5x11  | 80-T15                                     |

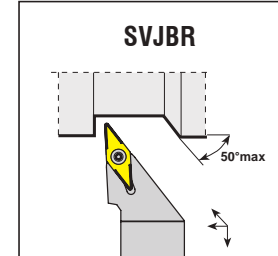
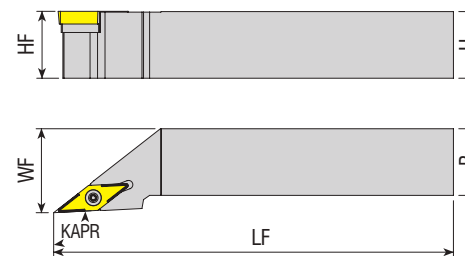

**Takım Kodu**  
**Ordering Code**  
*Bestell-Bezeichnung*

| R | L | Takım Ölçüleri (mm)<br>Dimension (mm)<br>Abmessung (mm) |    |     |    |
|---|---|---|----|-----|----|
|   |   | HF=H  | B  | LF  | WF |
| ● | ● | 12  | 12 | 80  | 16 |
| ● | ● | 16  | 16 | 100 | 20 |
| ● | ● | 20  | 20 | 125 | 25 |
| ● | ● | 16  | 16 | 100 | 20 |
| ● | ● | 20  | 20 | 125 | 25 |
| ● | ● | 25  | 25 | 150 | 32 |
| ● | ● | 32  | 32 | 170 | 40 |

| Kesici Uç<br>Insert<br>Wendeschneidplatte | Yedek Parçaları / Spare Parts / Ersatzteile |                             |   |  |
|---|---|-----------------------------|---|--|
|   | Sıkma Vidası<br>Screw<br>Klemmschraube      | Altlık<br>Shim<br>Unterlage | Altlık Vidası<br>Shim Screw<br>Schraube für Unterlage | Tork Anahtar<br>Torx Key<br>Torx-Schlüssel |
|   |   |                             |   |  |
| <b>VB.T 1103..</b>                        | 4008-M2.5x6                                 | -                           | -   | 82-T08                                     |
| <b>VB.T 1604..</b>                        | 4015-M3.5x12                                | AAVN-2-0002                 | AAV-08-M3.5x8   | 80-T15                                     |
|   | 4015-M3.5x14                                |                             | AAV-06-M3.5x11  |  |

R: Sağ / Right / Rechts L: Sol / Left / Links  
● Stokta / In Stock / Auf Lager ○ Stokta Yok / Non Stock Item / Kein Lagerartikel, Lieferzeit auf Anfrage

Sipariş Örneği/Ordering Example/Bestellbeispiel  
1 ad./pcs./stück SVHCR 1212 F11

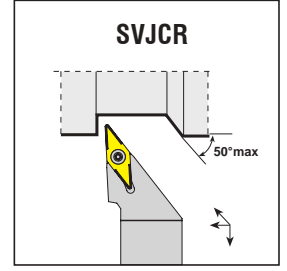
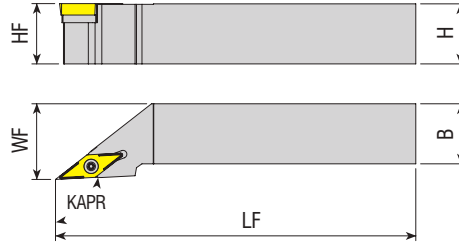

| Takım Kodu<br>Ordering Code<br>Bestell-Bezeichnung | Stok<br>Stock<br>Lager |   | Takım Ölçüleri (mm)<br>Dimension (mm)<br>Abmessung (mm) |    |     |    | Kesici Uç<br>Insert<br>Wendeschneidplatte | Sıkma Vidası<br>Screw<br>Klemmschraube | Altılık<br>Shim<br>Unterlage | Altılık Vidası<br>Shim Screw<br>Schraube für Unterlage | Tork Anahtar<br>Torx Key<br>Torx-Schlüssel |
|--|------------------------|---|---|----|-----|----|---|--|------------------------------|--|--|
|  | R                      | L | HF=H  | B  | LF  | WF |   |  |                              |  |  |
|  |                        |   |   |    |     |    |   |  |                              |  |  |
| SVJCR/L 1212 F11                                   | ●                      | ● | 12  | 12 | 80  | 16 | VC.T 1103..                               | 4008-M2.5x6                            | -                            | -  | 82-T08                                     |
| 1616 H11   | ●                      | ● | 16  | 16 | 100 | 20 |   |  |                              |  |  |
| 2020 K11   | ●                      | ● | 20  | 20 | 125 | 25 |   |  |                              |  |  |
| 2525 M11   | ●                      | ● | 25  | 25 | 150 | 32 |   |  |                              |  |  |
| 1212 F16   | ●                      | ● | 12  | 12 | 80  | 16 | VC.T 1604..                               | 4015-M3.5x11                           | AAVN-2-0002                  | AAV-06-M3.5x11   | 80-T15                                     |
| 2020 K16   | ●                      | ● | 20  | 20 | 125 | 25 |   |  |                              |  |  |
| 2525 M16   | ●                      | ● | 25  | 25 | 150 | 32 |   |  |                              |  |  |
| 3232 P16   | ●                      | ● | 32  | 32 | 170 | 40 |   |  |                              |  |  |

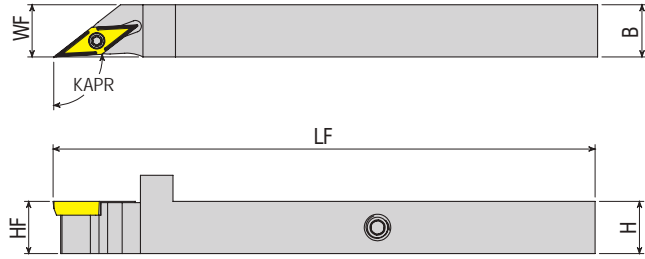

| Takım Kodu<br>Ordering Code<br>Bestell-Bezeichnung | Stok<br>Stock<br>Lager |   | Takım Ölçüleri (mm)<br>Dimension (mm)<br>Abmessung (mm) |    |     |    | Kesici Uç<br>Insert<br>Wendeschneidplatte | Sıkma Vidası<br>Screw<br>Klemmschraube | Altılık<br>Shim<br>Unterlage | Altılık Vidası<br>Shim Screw<br>Schraube für Unterlage | Sızdırmaz Vida<br>Threaded Pin<br>Gewindestift | Anahtar<br>Allen Key<br>Innensechskantschlüssel | Tork Anahtar<br>Torx Key<br>Torx-Schlüssel |
|--|------------------------|---|---|----|-----|----|---|--|------------------------------|--|--|---|--|
|  | R                      | L | HF=H  | B  | LF  | WF |   |  |                              |  |  |   |  |
|  |                        |   |   |    |     |    |   |  |                              |  |  |   |  |
| SVJCR/L 1212 K11-SHP                               | ●                      | ○ | 12  | 12 | 125 | 12 | VC.T 1103..                               | 4008-M2.5x6                            | -                            | -  | 2703-M6X4                                      | AAL-03-3  | 82-T08                                     |
| 1616 K11-SHP                                       | ●                      | ○ | 16  | 16 | 125 | 16 |   |  |                              |  | 2704-M8X1X5                                    | AAL-05-4  |  |

R: Sağ / Right / Rechts L: Sol / Left / Links

● Stokta / In Stock / Auf Lager ○ Stokta Yok / Non Stock Item / Kein Lagerartikel, Lieferzeit auf Anfrage  
ISO Ucuna Uygunudur. / Compatible with ISO Insert. / Kompatibel mit ISO Wendeplatten.

Sipariş Örneği/Ordering Example/Bestellbeispiel  
1 ad./pcs./stück SVJCR 1212 F11



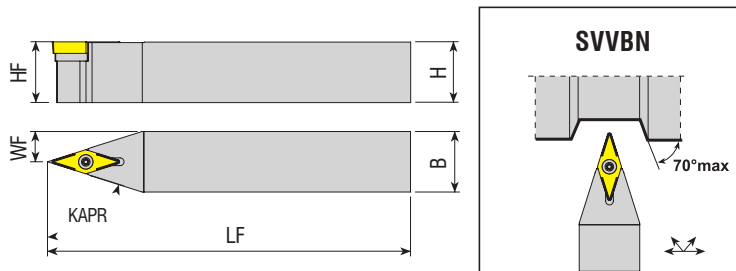

| Takım Kodu<br>Ordering Code<br>Bestell-Bezeichnung | Stok<br>Stock<br>Lager | Takım Ölçüleri (mm)<br>Dimension (mm)<br>Abmessung (mm) |    |     |      | Kesici Uç<br>Insert<br>Wendeschneidplatte | Yedek Parçaları / Spare Parts / Ersatzteile |                            |  |  |
|--|------------------------|---|----|-----|------|---|---|----------------------------|--|--|
|  |                        | HF=H  | B  | LF  | WF   |   | Sıkma Vidası<br>Screw<br>Klemmschraube      | Altık<br>Shim<br>Unterlage | Altık Vidası<br>Shim Screw<br>Schraube für Unterlage | Tork Anahtar<br>Torx Key<br>Torx-Schlüssel |
| SVVBN 1212 F11                                     | ●                      | 12  | 12 | 80  | 06   | VB.T 1103..                               | 4008-M2.5x6                                 | -                          | -  | 82-T08                                     |
| 1616 H11   | ●                      | 16  | 16 | 100 | 08   |   |   |                            |  |  |
| 2020 K11   | ●                      | 20  | 20 | 125 | 10   |   |   |                            |  |  |
| 2020 K16   | ●                      | 20  | 20 | 125 | 10   | VB.T 1604..                               | 4015-M3.5x14                                | AAVN-2-0002                | AAV-06-M3.5x11                                       | 80-T15                                     |
| 2525 M16   | ●                      | 25  | 25 | 150 | 12.5 |   |   |                            |  |  |
| 3232 P16   | ●                      | 32  | 32 | 170 | 16   |   |   |                            |  |  |

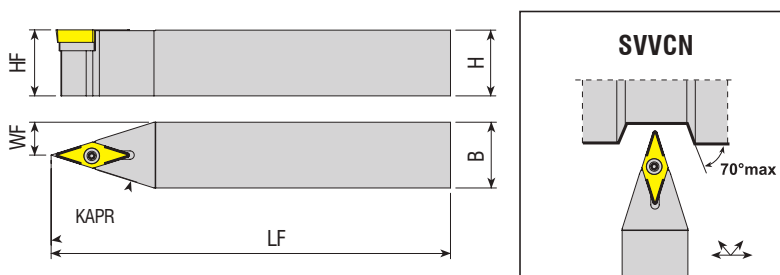

| Takım Kodu<br>Ordering Code<br>Bestell-Bezeichnung | Stok<br>Stock<br>Lager | Takım Ölçüleri (mm)<br>Dimension (mm)<br>Abmessung (mm) |    |     |      | Kesici Uç<br>Insert<br>Wendeschneidplatte | Yedek Parçaları / Spare Parts / Ersatzteile |                            |  |  |
|--|------------------------|---|----|-----|------|---|---|----------------------------|--|--|
|  |                        | HF=H  | B  | LF  | WF   |   | Sıkma Vidası<br>Screw<br>Klemmschraube      | Altık<br>Shim<br>Unterlage | Altık Vidası<br>Shim Screw<br>Schraube für Unterlage | Tork Anahtar<br>Torx Key<br>Torx-Schlüssel |
| SVVCN 1212 F11                                     | ●                      | 12  | 12 | 80  | 06   | VC.T 1103..                               | 4008-M2.5x6                                 | -                          | -  | 82-T08                                     |
| 1616 H11   | ●                      | 16  | 16 | 100 | 08   |   |   |                            |  |  |
| 2020 K11   | ●                      | 20  | 20 | 125 | 10   |   |   |                            |  |  |
| 2020 K16   | ●                      | 20  | 20 | 125 | 10   | VC.T 1604..                               | 4015-M3.5x14                                | AAVN-2-0002                | AAV-06-M3.5x11                                       | 80-T15                                     |
| 2525 M16   | ●                      | 25  | 25 | 150 | 12.5 |   |   |                            |  |  |
| 3232 P16   | ●                      | 32  | 32 | 170 | 16   |   |   |                            |  |  |

R: Sağ / Right / Rechts L: Sol / Left / Links

● Stokta / In Stock / Auf Lager ○ Stokta Yok / Non Stock Item / Kein Lagerartikel, Lieferzeit auf Anfrage

Sipariş Örneği/Ordering Example/Bestellbeispiel

1 ad./pcs./stück SVVBN 1212 F11

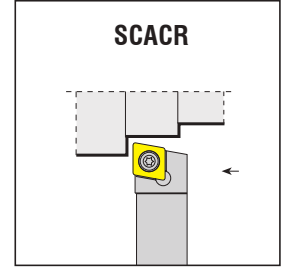
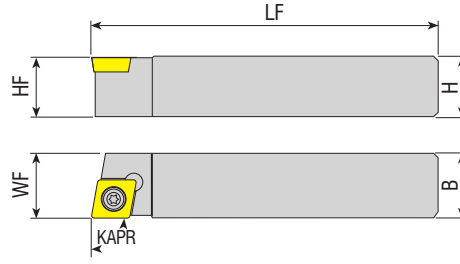

**Takım Kodu**  
**Ordering Code**  
**Bestell-Bezeichnung**

Stok  
Stock  
Lager

Takım Ölçüleri (mm)  
Dimension (mm)  
Abmessung (mm)

Kesici Uç  
Insert  
Wendeschneidplatte

Yedek Parçaları / Spare Parts / Ersatzteile

Sıkma Vidası  
Screw  
Klemmschraube

Altlık  
Shim  
Unterlage

Altlık Vidası  
Shim Screw  
Schraube für Unterlage

Tork Anahtar  
Torx Key  
Torx-Schlüssel

R L

HF=H

B

LF

WF

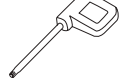

| Takım Kodu<br>Ordering Code<br>Bestell-Bezeichnung | R | L | HF=H | B  | LF  | WF |
|--|---|---|------|----|-----|----|
| SCACR/L 0808 X06-S                                 | ● | ● | 08   | 08 | 115 | 08 |
| 1010 K06-S   | ● | ○ | 10   | 10 | 125 | 10 |
| 1212 G06-S   | ● | ○ | 12   | 12 | 90  | 12 |
| 1212 K06-S   | ● | ○ | 12   | 12 | 125 | 12 |
| 1616 F06-S   | ○ | ○ | 16   | 16 | 75  | 16 |
| 1616 K06-S   | ○ | ○ | 16   | 16 | 125 | 16 |
| 1212 G09-S   | ○ | ○ | 12   | 12 | 90  | 12 |
| 1212 K09-S   | ● | ● | 12   | 12 | 125 | 12 |
| 1616 F09-S   | ○ | ○ | 16   | 16 | 75  | 16 |
| 1616 K09-S   | ● | ● | 16   | 16 | 125 | 16 |
| 2020 K09-S   | ● | ● | 20   | 20 | 125 | 20 |

CC.T 0602..

4008-M2.5x6

-

-

82-T08

CC.T 09T3..

4015-M3.5x11

-

-

80-T15

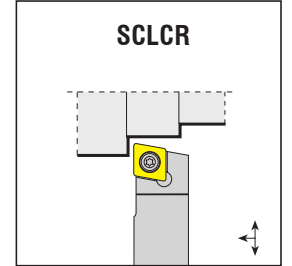
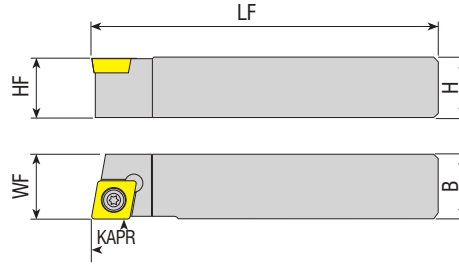

**Takım Kodu**  
**Ordering Code**  
**Bestell-Bezeichnung**

Stok  
Stock  
Lager

Takım Ölçüleri (mm)  
Dimension (mm)  
Abmessung (mm)

Kesici Uç  
Insert  
Wendeschneidplatte

Yedek Parçaları / Spare Parts / Ersatzteile

Sıkma Vidası  
Screw  
Klemmschraube

Altlık  
Shim  
Unterlage

Altlık Vidası  
Shim Screw  
Schraube für Unterlage

Tork Anahtar  
Torx Key  
Torx-Schlüssel

R L

HF=H

B

LF

WF

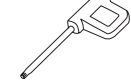

| Takım Kodu<br>Ordering Code<br>Bestell-Bezeichnung | R | L | HF=H | B  | LF  | WF |
|--|---|---|------|----|-----|----|
| SCLCR/L 0808 X06-S                                 | ● | ● | 08   | 08 | 115 | 08 |
| 1010 X06-S   | ● | ○ | 10   | 10 | 115 | 10 |
| 1212 G06-S   | ● | ● | 12   | 12 | 90  | 12 |
| 1212 X06-S   | ● | ○ | 12   | 12 | 130 | 12 |
| 1212 K06-S   | ○ | ● | 12   | 12 | 125 | 12 |
| 1616 F06-S   | ● | ○ | 16   | 16 | 75  | 16 |
| 1616 X06-S   | ● | ○ | 16   | 16 | 130 | 16 |
| 1212 G09-S   | ● | ● | 12   | 12 | 90  | 12 |
| 1212 X09-S   | ● | ○ | 12   | 12 | 130 | 12 |
| 1616 F09-S   | ● | ○ | 16   | 16 | 75  | 16 |
| 1616 G09-S   | ● | ○ | 16   | 16 | 90  | 16 |
| 1616 X09-S   | ● | ○ | 16   | 16 | 115 | 16 |
| 2020 X09-S   | ● | ○ | 20   | 20 | 120 | 20 |

CC.T 0602..

4008-M2.5x6

-

-

82-T08

CC.T 09T3..

4015-M3.5x11

-

-

80-T15

R: Sağ / Right / Rechts L: Sol / Left / Links

● Stokta / In Stock / Auf Lager ○ Stokta Yok / Non Stock Item / Kein Lagerartikel, Lieferzeit auf Anfrage



www.akko.com.tr

Sipariş Örneği/Ordering Example/Bestellbeispiel

1 ad./pcs./stück SCACR 0808 X06-S

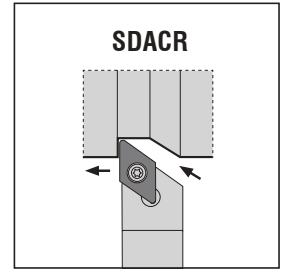
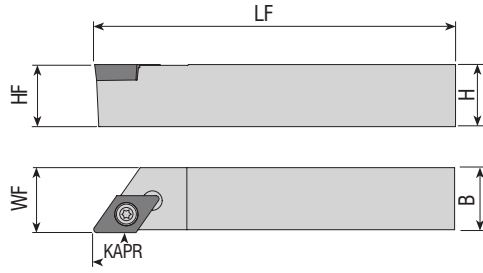

**Takım Kodu**  
**Ordering Code**  
*Bestell-Bezeichnung*

| Stok<br>Stock<br>Lager    | Takım Ölçüleri (mm)<br>Dimension (mm)<br>Abmessung (mm) |   |      |    |     | Kesici Uç<br>Insert<br>Wendeschneidplatte | Yedek Parçaları / Spare Parts / Ersatzteile |  |                              |  |  |
|---------------------------|---|---|------|----|-----|---|---|--|------------------------------|--|--|
|                           | R   | L | HF=H | B  | LF  |   | WF  | Sıkma Vidası<br>Screw<br>Klemmschraube | Altılık<br>Shim<br>Unterlage | Altılık Vidası<br>Shim Screw<br>Schraube für Unterlage | Tork Anahtar<br>Torx Key<br>Torx-Schlüssel |
|                           | R   | L | HF=H | B  | LF  | WF  |   |  |                              |  |  |
| <b>SDACR/L 0808 X07-S</b> | ●   | ● | 08   | 08 | 115 | 08  | <b>DC.T 0702..</b>                          | 4008-M2.5x6                            | -                            | -  | 82-T08                                     |
| <b>1010 K07-S</b>         | ●   | ● | 10   | 10 | 125 | 10  |   |  |                              |  |  |
| <b>1212 G07-S</b>         | ○   | ○ | 12   | 12 | 90  | 12  |   |  |                              |  |  |
| <b>1212 K07-S</b>         | ●   | ● | 12   | 12 | 125 | 12  |   |  |                              |  |  |
| <b>1616 F07-S</b>         | ●   | ○ | 16   | 16 | 75  | 16  |   |  |                              |  |  |
| <b>1616 K07-S</b>         | ●   | ● | 16   | 16 | 125 | 16  |   |  |                              |  |  |
| <b>1212 G11-S</b>         | ○   | ○ | 12   | 12 | 90  | 12  | <b>DC.T 11T3..</b>                          | 4015-M3.5x11                           | -                            | -  | 80-T15                                     |
| <b>1212 K11-S</b>         | ●   | ● | 12   | 12 | 125 | 12  |   |  |                              |  |  |
| <b>1616 F11-S</b>         | ●   | ● | 16   | 16 | 75  | 16  |   |  |                              |  |  |
| <b>1616 K11-S</b>         | ●   | ● | 16   | 16 | 125 | 16  |   |  |                              |  |  |
| <b>2020 K11-S</b>         | ●   | ● | 20   | 20 | 125 | 20  |   |  |                              |  |  |

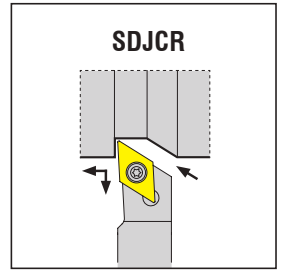
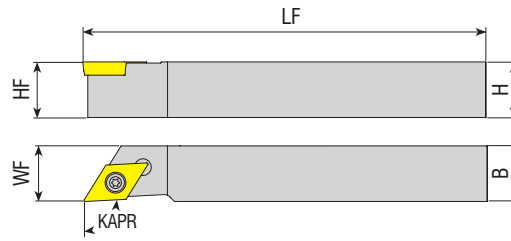

**Takım Kodu**  
**Ordering Code**  
*Bestell-Bezeichnung*

| Stok<br>Stock<br>Lager    | Takım Ölçüleri (mm)<br>Dimension (mm)<br>Abmessung (mm) |   |      |    |     | Kesici Uç<br>Insert<br>Wendeschneidplatte | Yedek Parçaları / Spare Parts / Ersatzteile |  |                              |  |  |
|---------------------------|---|---|------|----|-----|---|---|--|------------------------------|--|--|
|                           | R   | L | HF=H | B  | LF  |   | WF  | Sıkma Vidası<br>Screw<br>Klemmschraube | Altılık<br>Shim<br>Unterlage | Altılık Vidası<br>Shim Screw<br>Schraube für Unterlage | Tork Anahtar<br>Torx Key<br>Torx-Schlüssel |
|                           | R   | L | HF=H | B  | LF  | WF  |   |  |                              |  |  |
| <b>SDJCR/L 0808 X07-S</b> | ●   | ○ | 08   | 08 | 115 | 08  | <b>DC.T 0702..</b>                          | 4008-M2.5x6                            | -                            | -  | 82-T08                                     |
| <b>1010 X07-S</b>         | ●   | ● | 10   | 10 | 115 | 10  |   |  |                              |  |  |
| <b>1212 G07-S</b>         | ●   | ○ | 12   | 12 | 90  | 12  |   |  |                              |  |  |
| <b>1212 X07-S</b>         | ●   | ● | 12   | 12 | 130 | 12  |   |  |                              |  |  |
| <b>1616 F07-S</b>         | ●   | ○ | 16   | 16 | 75  | 16  |   |  |                              |  |  |
| <b>1616 X07-S</b>         | ●   | ○ | 16   | 16 | 130 | 16  |   |  |                              |  |  |
| <b>2020 X07-S</b>         | ●   | ○ | 20   | 20 | 120 | 20  | <b>DC.T 11T3..</b>                          | 4015-M3.5x11                           | -                            | -  | 80-T15                                     |
| <b>1212 G11-S</b>         | ●   | ○ | 12   | 12 | 90  | 12  |   |  |                              |  |  |
| <b>1212 X11-S</b>         | ●   | ● | 12   | 12 | 130 | 12  |   |  |                              |  |  |
| <b>1212 K11-S</b>         | ●   | ● | 12   | 12 | 125 | 12  |   |  |                              |  |  |
| <b>1616 F11-S</b>         | ●   | ○ | 16   | 16 | 75  | 16  |   |  |                              |  |  |
| <b>1616 X11-S</b>         | ●   | ● | 16   | 16 | 130 | 16  |   |  |                              |  |  |
| <b>1616 K11-S</b>         | ●   | ● | 16   | 16 | 125 | 16  |   |  |                              |  |  |
| <b>2020 X11-S</b>         | ●   | ○ | 20   | 20 | 120 | 20  |   |  |                              |  |  |

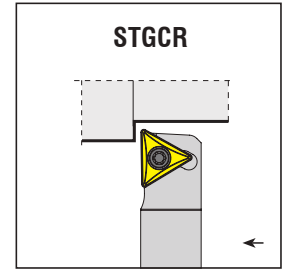
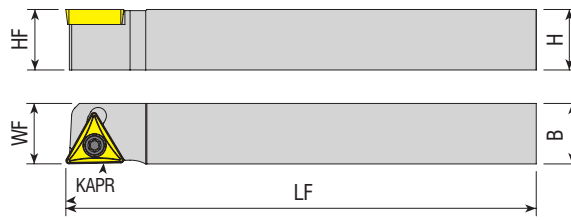

| Takım Kodu<br>Ordering Code<br>Bestell-Bezeichnung | Stok<br>Stock<br>Lager |   | Takım Ölçüleri (mm)<br>Dimension (mm)<br>Abmessung (mm) |    |     |    | Kesici Uç<br>Insert<br>Wendeschneidplatte | Yedek Parçaları / Spare Parts / Ersatzteile |                             |   |  |  |
|--|------------------------|---|---|----|-----|----|---|---|-----------------------------|---|--|--|
|  | R                      | L | HF=H  | B  | LF  | WF |   | Sıkma Vidası<br>Screw<br>Klemmschraube      | Altlık<br>Shim<br>Unterlage | Altlık Vidası<br>Shim Screw<br>Schraube für Unterlage | Tork Anahtar<br>Torx Key<br>Torx-Schlüssel |  |
|  | ●                      | ○ |   |    |     |    |   |   |                             |   |  |  |
| STGCR/L 1216 K11-S                                 | ●                      | ○ | 12  | 16 | 125 | 16 |   | 4008-M2.5x6                                 | -                           | -   | 82-T08                                     |  |
| 1616 K11-S   | ●                      | ○ | 16  | 16 | 125 | 16 |   |   |                             |   |  |  |
| 1216 K16-S   | ●                      | ○ | 12  | 16 | 125 | 16 |   | 4015-M3.5x11                                | -                           | -   | 80-T15                                     |  |
| 1616 K16-S   | ●                      | ○ | 16  | 16 | 125 | 16 |   |   |                             |   |  |  |

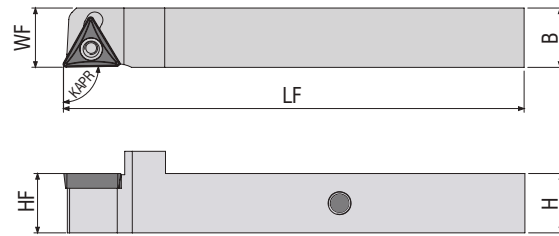

| Takım Kodu<br>Ordering Code<br>Bestell-Bezeichnung | Stok<br>Stock<br>Lager |   | Takım Ölçüleri (mm)<br>Dimension (mm)<br>Abmessung (mm) |    |     |    | Kesici Uç<br>Insert<br>Wendeschneidplatte | Yedek Parçaları / Spare Parts / Ersatzteile |                             |   |  |   |  |
|--|------------------------|---|---|----|-----|----|---|---|-----------------------------|---|--|---|--|
|  | R                      | L | HF=H  | B  | LF  | WF |   | Sıkma Vidası<br>Screw<br>Klemmschraube      | Altlık<br>Shim<br>Unterlage | Altlık Vidası<br>Shim Screw<br>Schraube für Unterlage | Sızdırmaz Vida<br>Threaded Pin<br>Gewindestift | Anahtar<br>Allen Key<br>Insechschlüssel | Tork Anahtar<br>Torx Key<br>Torx-Schlüssel |
|  | ●                      | ○ |   |    |     |    |   |   |                             |   |  |   |  |
| STGCR/L 1216 K16-SHP                               | ●                      | ○ | 12  | 16 | 125 | 16 |   | 4015-M3.5x14                                | AATN-2-0001                 | AAV-06-M3.5x11  | 2703-M6X4                                      | AAL-03-3                                | 80-T15                                     |
| 1616 K16-SHP                                       | ●                      | ○ | 16  | 16 | 125 | 16 |   |   |                             |   | 2704-M8X1X5                                    | AAL-05-4                                |  |

R: Sağ / Right / Rechts L: Sol / Left / Links  
● Stokta / In Stock / Auf Lager ○ Stokta Yok / Non Stock Item / Kein Lagerartikel, Lieferzeit auf Anfrage  
ISO Ucuna Uygundur. / Compatible with ISO Insert. / Kompatibel mit ISO Wendepplatten.

Sipariş Örneği/Ordering Example/Bestellbeispiel  
1 ad./pcs./stück STGCR 1216 K11-S

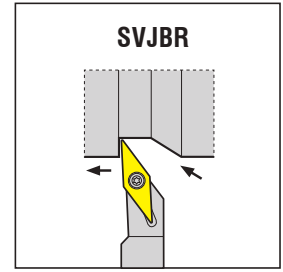
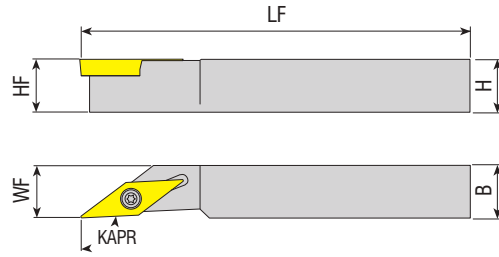

**Takım Kodu**  
**Ordering Code**  
*Bestell-Bezeichnung*

| Stok<br>Stock<br>Lager | Takım Ölçüleri (mm)<br>Dimension (mm)<br>Abmessung (mm) |   |      |   |    |    | Kesici Uç<br>Insert<br>Wendeschneidplatte | Yedek Parçaları / Spare Parts / Ersatzteile |                             |   |  |
|------------------------|---|---|------|---|----|----|---|---|-----------------------------|---|--|
|                        | R   | L | HF=H | B | LF | WF |   | Sıkma Vidası<br>Screw<br>Klemmschraube      | Altlık<br>Shim<br>Unterlage | Altlık Vidası<br>Shim Screw<br>Schraube für Unterlage | Tork Anahtar<br>Torx Key<br>Torx-Schlüssel |
|                        |   |   |      |   |    |    |   |   |                             |   |  |
|                        |   |   |      |   |    |    | <b>VB.T 1103..</b>                        | 4008-M2.5x6                                 | -                           | -   | 82-T08                                     |

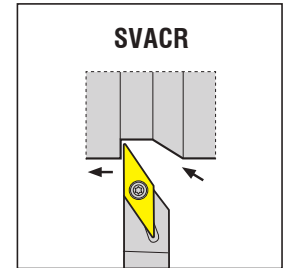
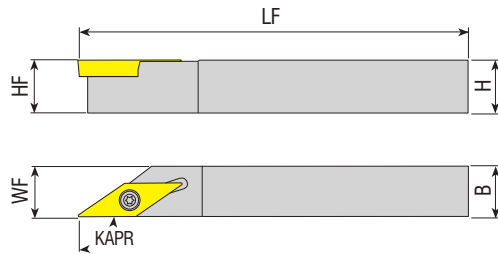

**Takım Kodu**  
**Ordering Code**  
*Bestell-Bezeichnung*

| Stok<br>Stock<br>Lager | Takım Ölçüleri (mm)<br>Dimension (mm)<br>Abmessung (mm) |   |      |   |    |    | Kesici Uç<br>Insert<br>Wendeschneidplatte | Yedek Parçaları / Spare Parts / Ersatzteile |                             |   |  |
|------------------------|---|---|------|---|----|----|---|---|-----------------------------|---|--|
|                        | R   | L | HF=H | B | LF | WF |   | Sıkma Vidası<br>Screw<br>Klemmschraube      | Altlık<br>Shim<br>Unterlage | Altlık Vidası<br>Shim Screw<br>Schraube für Unterlage | Tork Anahtar<br>Torx Key<br>Torx-Schlüssel |
|                        |   |   |      |   |    |    |   |   |                             |   |  |
|                        |   |   |      |   |    |    | <b>VC.T 1103..</b>                        | 4008-M2.5x6                                 | -                           | -   | 82-T08                                     |
|                        |   |   |      |   |    |    |   |   |                             |   |  |
|                        |   |   |      |   |    |    | <b>VC.T 1604..</b>                        | 4015-M3.5x11                                |                             |   | 80-T15                                     |

R: Sağ / Right / Rechts L: Sol / Left / Links  
● Stokta / In Stock / Auf Lager ○ Stokta Yok / Non Stock Item / Kein Lagerartikel, Lieferzeit auf Anfrage

Sipariş Örneği/Ordering Example/Bestellbeispiel  
1 ad./pcs./stück SVJBR 1616 K11-S

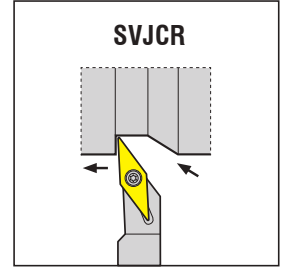
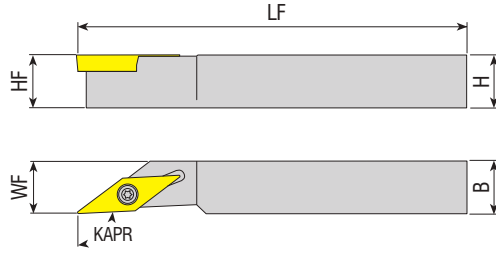

| Takım Kodu<br>Ordering Code<br>Bestell-Bezeichnung | Stok<br>Stock<br>Lager |   | Takım Ölçüleri (mm)<br>Dimension (mm)<br>Abmessung (mm) |    |     |    | Kesici Uç<br>Insert<br>Wendeschneidplatte | Yedek Parçaları / Spare Parts / Ersatzteile |                            |  |  |
|--|------------------------|---|---|----|-----|----|---|---|----------------------------|--|--|
|  | R                      | L | HF=H  | B  | LF  | WF |   | Sıkma Vidası<br>Screw<br>Klemmschraube      | Altık<br>Shim<br>Unterlage | Altık Vidası<br>Shim Screw<br>Schraube für Unterlage | Tork Anahtar<br>Torx Key<br>Torx-Schlüssel |
| SVJCR/L 0808 X11-S                                 | ●                      | ○ | 08  | 08 | 115 | 08 | VC.T 1103..                               | 4008-M2.5x6                                 | -                          | -  | 82-T08                                     |
| 1010 K11-S   | ●                      | ○ | 10  | 10 | 125 | 10 |   |   |                            |  |  |
| 1212 G11-S   | ○                      | ○ | 12  | 12 | 90  | 12 |   |   |                            |  |  |
| 1212 K11-S   | ●                      | ○ | 12  | 12 | 125 | 12 |   |   |                            |  |  |
| 1616 F11-S   | ○                      | ○ | 16  | 16 | 75  | 16 |   |   |                            |  |  |
| 1616 K11-S   | ●                      | ○ | 16  | 16 | 125 | 16 |   |   |                            |  |  |
| 2020 K11-S   | ○                      | ○ | 20  | 20 | 125 | 20 |   |   |                            |  |  |

## SEC TOOLS

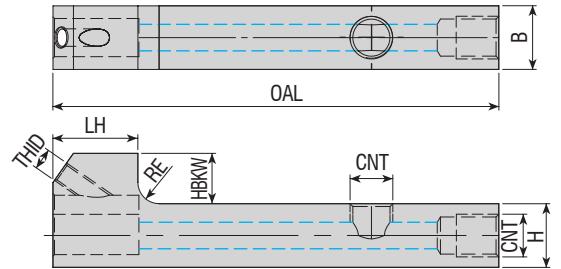

| Takım Kodu<br>Ordering Code<br>Bestell-Bezeichnung | Stok<br>Stock<br>Lager | Takım Ölçüleri (mm)<br>Dimension (mm)<br>Abmessung (mm) |    |    |      |    |     |        |        | Yedek Parçaları / Spare Parts / Ersatzteile      |   |   |
|--|------------------------|---|----|----|------|----|-----|--------|--------|--|---|---|
|  |                        | H   | B  | RE | HBKW | LH | OAL | CNT    | THID   | Sızdırmaz Vida<br>Threaded Pin<br>Резьбовой Винт | Montaj Vidası<br>Mounting Screw<br>Монтажный Винт | Anahtar<br>Allen Key<br>Innensechskantschlüssel |
| ASTB-1212-L84-H                                    | ●                      | 12  | 12 | 4  | 9.5  | 16 | 84  | M8X1X5 | M4x0.7 | 2704-M8X1X5                                      | 2503-M4x12-C                                      | AAL-03-3  |
| ASTB-1616-L90-H                                    | ●                      | 16  | 16 | 1  | 5.5  | 16 | 90  | M8X1X5 | M4x0.7 |  |   |   |

R: Sağ / Right / Rechts L: Sol / Left / Links  
● Stokta / In Stock / Auf Lager ○ Stokta Yok / Non Stock Item / Kein Lagerartikel, Lieferzeit auf Anfrage

Sipariş Örneği/Ordering Example/Bestellbeispiel  
1 ad./pcs./stück SVJCR 0808 X11-S

KAPR=93°

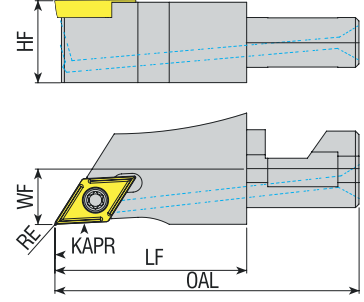

| Takım Kodu<br>Ordering Code<br>Bestell-Bezeichnung | Stok<br>Stock<br>Lager |   | Takım Ölçüleri (mm)<br>Dimension (mm)<br>Abmessung (mm) |    |     |      |      | Kesici Uç<br>Insert<br>Wendeschneidplatte | Yedek Parçaları / Spare Parts / Ersatzteile |  |
|--|------------------------|---|---|----|-----|------|------|---|---|--|
|  | R                      | L | HF  | WF | RE  | LF   | OAL  |   | Sıkma Vidası<br>Screw<br>Klemmschraube      | Tork Anahtar<br>Torx Key<br>Torx-Schlüssel |
| SDJCR/L-12X43.3-07                                 | ●                      | ● | 11.8  | 8  | 0.2 | 27.3 | 43.3 | DC.T 070202                               | 4008-M2.5x6                                 | 82-T08                                     |
| 12X43.3-07-H                                       | ●                      | ● | 11.8  | 8  | 0.2 | 27.3 | 43.3 |   |   |  |
| 16X43.3-07   | ●                      | ● | 15.8  | 8  | 0.2 | 27.3 | 43.3 |   |   |  |
| 16X43.3-07-H                                       | ●                      | ● | 15.8  | 8  | 0.2 | 27.3 | 43.3 |   |   |  |
| 12X43.3-11   | ●                      | ● | 11.8  | 8  | 0.2 | 27.3 | 43.3 | DC.T 11T302                               | 4015-M3.5x9                                 | 80-T15                                     |
| 12X43.3-11-H                                       | ●                      | ● | 11.8  | 8  | 0.2 | 27.3 | 43.3 |   |   |  |
| 16X43.3-11   | ●                      | ● | 15.8  | 8  | 0.2 | 27.3 | 43.3 |   |   |  |
| 16X43.3-11-H                                       | ●                      | ● | 15.8  | 8  | 0.2 | 27.3 | 43.3 |   |   |  |

KAPR=93°

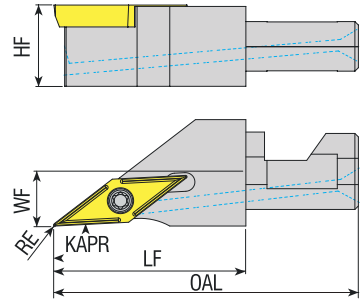

| Takım Kodu<br>Ordering Code<br>Bestell-Bezeichnung | Stok<br>Stock<br>Lager |   | Takım Ölçüleri (mm)<br>Dimension (mm)<br>Abmessung (mm) |    |     |      |      | Kesici Uç<br>Insert<br>Wendeschneidplatte | Yedek Parçaları / Spare Parts / Ersatzteile |  |
|--|------------------------|---|---|----|-----|------|------|---|---|--|
|  | R                      | L | HF  | WF | RE  | LF   | OAL  |   | Sıkma Vidası<br>Screw<br>Klemmschraube      | Tork Anahtar<br>Torx Key<br>Torx-Schlüssel |
| SVJCR/L-12X43.3-11                                 | ●                      | ● | 11.8  | 8  | 0.2 | 27.3 | 43.3 | VC.T 110302                               | 4008-M2.5x6                                 | 82-T08                                     |
| 12X43.3-11-H                                       | ●                      | ● | 11.8  | 8  | 0.2 | 27.3 | 43.3 |   |   |  |
| 16X43.3-11   | ●                      | ● | 15.8  | 8  | 0.2 | 27.3 | 43.3 |   |   |  |
| 16X43.3-11-H                                       | ●                      | ● | 15.8  | 8  | 0.2 | 27.3 | 43.3 |   |   |  |

R: Sağ / Right / Rechts L: Sol / Left / Links

● Stokta / In Stock / Auf Lager ○ Stokta Yok / Non Stock Item / Kein Lagerartikel, Lieferzeit auf Anfrage

Sipariş Örneği/Ordering Example/Bestellbeispiel

1 ad./pcs./stück SDJCR-12X43.3-07

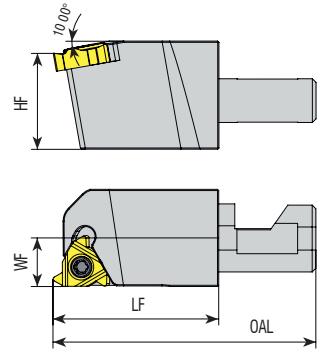

**Takım Kodu**  
**Ordering Code**  
**Bestell-Bezeichnung**

| Stok<br>Stock<br>Lager |   | Takım Ölçüleri (mm)<br>Dimension (mm)<br>Abmessung (mm) |      |     |      |                 | Kesici Uç<br>Insert<br>Wendeschneidplatte | Yedek Parçaları / Spare Parts / Ersatzteile |  |   |   |  |
|------------------------|---|---|------|-----|------|-----------------|---|---|--|---|---|--|
|                        |   | R   | L    | OAL | LF   | WF              |   | HF  | Sıkma Vidası<br>Screw<br>Klemmschraube | Sağ Altlık<br>Right Shim<br>U-Platte für WSP rechts | Sol Altlık<br>Left Shim<br>U-Platte für WSP links | Altık Vidası<br>Shim Screw<br>Schraube für Unterlage |
| ●                      | ● | 43.3  | 27.3 | 8   | 11.8 |                 |   |   |  |   |   |  |
| ●                      | ● | 43.3  | 27.3 | 8   | 15.8 | <b>11 ER/EL</b> | 4008-M2.5x6                               | -   | -                                      | -   | -   | 82-T08   |
| ●                      | ● | 43.3  | 27.3 | 8   | 15.8 | <b>16 ER/EL</b> | 1710-U5-40x12.2                           | ATS-16E                                     | ATS-16I                                | AAV-11-U5-40x4.5                                    | ABPL-03   | 82-T10   |

R: Sağ / Right / Rechts L: Sol / Left / Links

● Stokta / In Stock / Auf Lager ○ Stokta Yok / Non Stock Item / Kein Lagerartikel, Lieferzeit auf Anfrage

Sipariş Örneği/Ordering Example/Bestellbeispiel

1 ad./pcs./stück SER/L-12x43.3-11



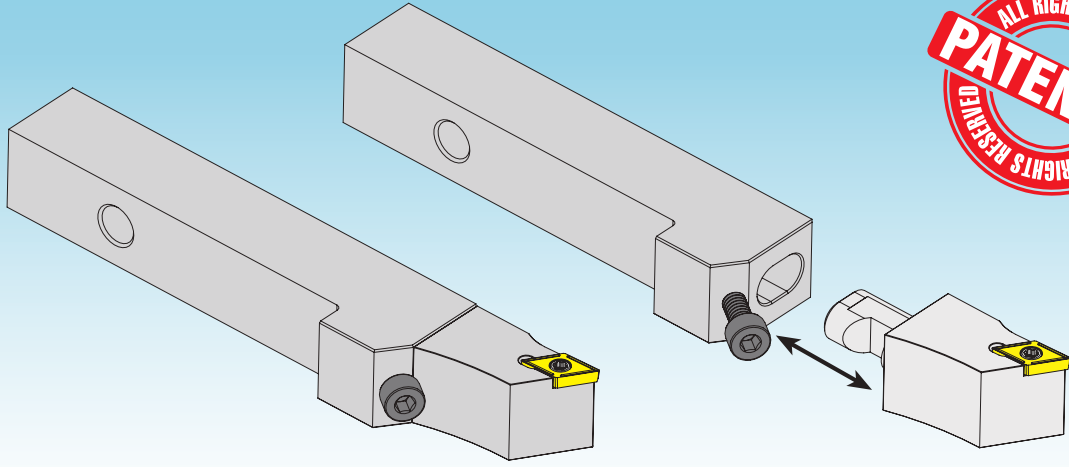

Takım tutucuyu, bağlama ünitesinden sökme zorunluğunu kalmadan hızlıca değiştirin!

Quick change, without having to remove the tool-holder from the gang !

Es ist nicht nötig, den Grundhalter vom Werkzeugträger zu entfernen schnelle wechsell möglich!

Makina dışında ön ayar yapmak mümkün.

Presetting is possible outside of the machine.

Voreinstellung ausserhalb der Maschine ist möglich.

Çok hassas montaj.

Ultra precise fitting.

Ultra-präziser Montage.

Rijit sabitleme.

Rigid fixation.

Starre Befestigung.

Takım tutucu bölümü: 12x12 ve 16x16 mm.

Tool-holder section : 12x12 and 16x16 mm.

Grundhalter: 12x12 und 16x16mm.

Sağ ve sol uçlar kullanılır.

Left and right inserts available.

Links und Rechts WSP verwendbar.

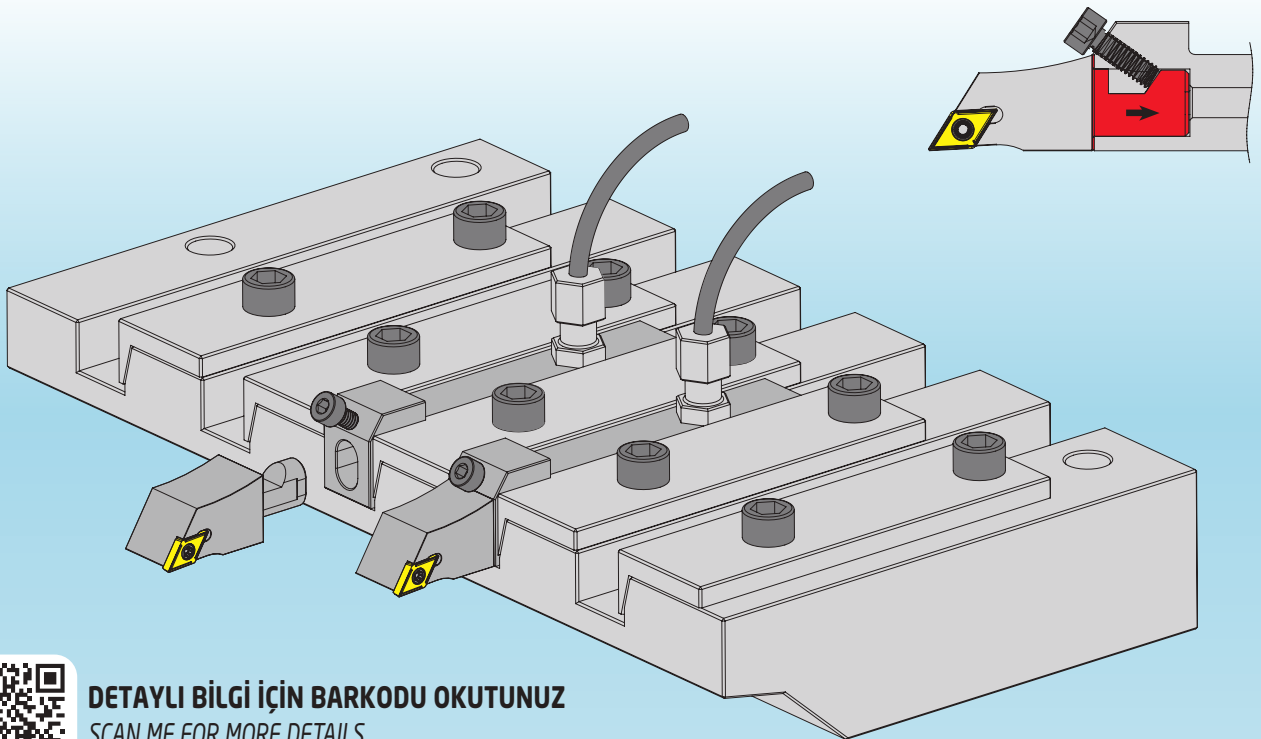

**DETAYLI BİLGİ İÇİN BARKODU OKUTUNUZ**

SCAN ME FOR MORE DETAILS

SCANNEN SIE MICH NACH WEITEREN DETAILS



**DELİK TORNA TAKIMLARI**  
*INTERNAL TURNING TOOLHOLDERS*  
*DREHWERKZEUGE FÜR DIE INNENBEARBEITUNG*





**S**

1

**25**

2

**S**

3

**P**

4

**C**

5

**L**

6

**N**

7

**R**

8

**12**

9

**C**

10

**1** Takım Malzemesi / Type of Boring Bar / Art der Bohrstange

"A" Yekpare çelik gövde soğutma suyu kanallı / "A" Solid steel with coolant hole  
"A" Vollstahlausführung mit innerer Kühlmittelzufuhr  
"E" Carbide bar with fixed steel head and coolant hole  
"E" Hartmetallschaft mit Kopf aus Stahl und innerer Kühlmittelzufuhr  
"C" Karbür Şaft / "C" Carbide shank / "C" Hartmetallschaft mit Kopf aus Stahl ohne innere Kühlmittelzufuhr  
"S" Çelik Şaft / "S" Steel shank / "S" Vollstahlausführung ohne innere Kühlmittelzufuhr

**2** Şaft Çapı / Shank Diameter / Schaft Durchmesser

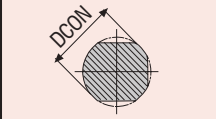

**3** Şaft Boyu / Shank Length / Schaft Länge

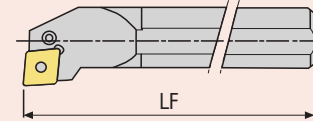

|        |         |         | (mm)      |
|--------|---------|---------|-----------|
| A - 32 | H - 100 | Q - 180 | x-special |
| B - 40 | J - 110 | R - 200 |           |
| C - 50 | K - 125 | S - 250 |           |
| D - 60 | L - 140 | T - 300 |           |
| E - 70 | M - 150 | U - 350 |           |
| F - 80 | N - 160 | V - 400 |           |
| G - 90 | P - 170 | W - 450 |           |

**4** Sıkma Tipi / Method of Mounting of Insert / Art der Schneideplattenbefestigung

|          |          |          |          |          |
|----------|----------|----------|----------|----------|
|          |          |          |          |          |
| <b>C</b> | <b>T</b> | <b>M</b> | <b>P</b> | <b>S</b> |

**5** Uç Tipi / Type of Insert / Plattenform

|          |          |          |
|----------|----------|----------|
|          |          |          |
| <b>C</b> | <b>D</b> | <b>E</b> |
|          |          |          |
| <b>V</b> | <b>R</b> | <b>S</b> |
|          |          |          |
| <b>W</b> | <b>K</b> | <b>T</b> |

**6** Yanaşma Açısı / Tool Holder Shape Bar Geometry / Anstellwinkel

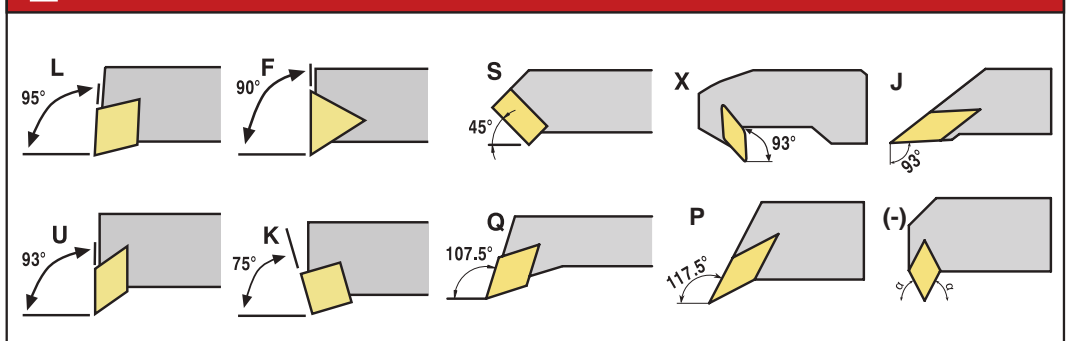

**7** Serbest Uç Açısı / Insert Clearance Angle / Freiwinkel

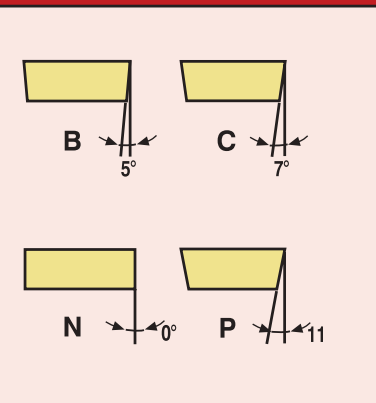

**8** Kesme Yönü / Cutting Direction / Halterausführung

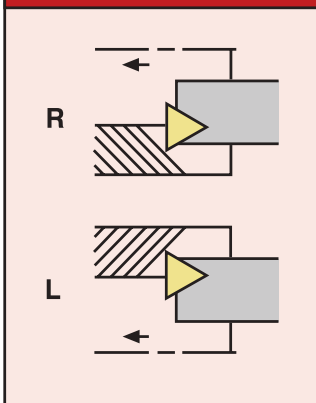

**9** Kesme Kenar Uzunluğu / Cutting Edge Length / Schneidkantenlänge

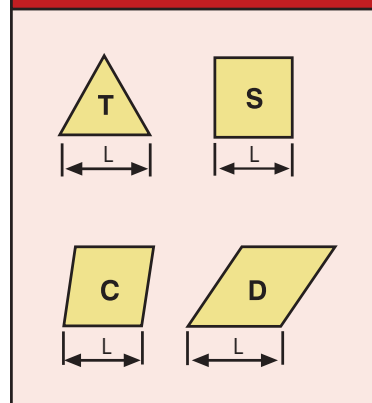

**10** Baskı Pabucu / Wedge Clamp / Spannpratze

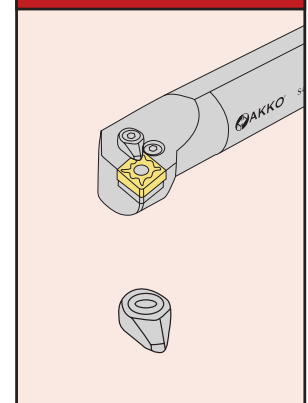



*konusulan  
the spoken kalite...  
quality...*

# T&C-SİSTEM

**T&C SİSTEM DELİK TORNA KATERLERİ**  
T&C SYSTEM BORING BARS  
T&C SYSTEM BOHRSTANGE



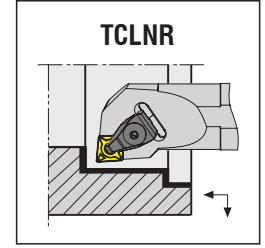
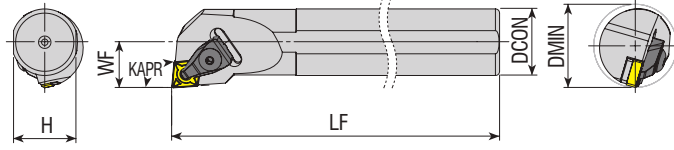

**Takım Kodu**  
**Ordering Code**  
**Bestell-Bezeichnung**

| Stok<br>Stock<br>Lager | Takım Ölçüleri (mm)<br>Dimension (mm)<br>Abmessung (mm) |   |      |      |     |    | Kesici Uç<br>Insert<br>Wendeschneidplatte | Yedek Parçaları / Spare Parts / Ersatzteile |  |  |                             |   |                         |                      |  |
|------------------------|---|---|------|------|-----|----|---|---|--|--|-----------------------------|---|-------------------------|----------------------|--|
|                        | R   | L | DCON | H    | LF  | WF |   | DMIN  | Baskı Pabucu<br>Wedge Clamp<br>Spannpratze | Pabuç Vidası<br>Clamp Screw<br>Klemmschraube | Altlık<br>Shim<br>Unterlage | Altlık Vidası<br>Shim Screw<br>Schraube für Unterlage | Segman<br>Ring<br>Feder | Pul<br>Stamp<br>Ring | Anahtar<br>Allen Key<br>Innerschloßschlüssel |
|                        | ●   | ● | 25   | 23   | 250 | 17 | ≥32                                       | CNM. 0903..                                 | ATK-01                                     | AKV-01-M5x22                                 | AACN-2-0001                 | AAV-09-M5x9   | -                       |                      |  |
|                        | ●   | ● | 25   | 23   | 250 | 17 | ≥32                                       |   |  |  |                             | AAV-13-M5x8   |                         |                      |  |
|                        | ●   | ● | 32   | 30   | 300 | 22 | ≥40                                       | CNM. 1204..                                 | ATK-02                                     | AKV-30-M6x22                                 | AACN-3-0001                 | AAV-02-M5x12  | AS-01                   | ABPL-01              | AAL-03-3                                     |
|                        | ●   | ● | 40   | 37.5 | 350 | 27 | ≥50                                       |   |  |  |                             |   |                         |                      |  |
|                        | ●   | ● | 50   | 47   | 400 | 35 | ≥63                                       |   |  |  |                             |   |                         |                      |  |
|                        | ●   | ● | 32   | 30   | 300 | 22 | ≥40                                       |   |  |  |                             |   |                         |                      |  |
|                        | ●   | ● | 40   | 37.5 | 350 | 27 | ≥50                                       | CNM. 1606..                                 | ATK-04                                     | AKV-19-M7x25                                 | AACN-3-0002                 | AAV-05-M6x15  | AS-02                   | ABPL-02              | AAL-05-4                                     |
|                        | ●   | ● | 50   | 47   | 400 | 35 | ≥63                                       |   |  |  |                             |   |                         |                      |  |
| new                    | ●   | ○ | 25   | 23   | 200 | 17 | ≥32                                       |   |  |  |                             | AAV-13-M5x8   |                         |                      |  |
| new                    | ●   | ○ | 40   | 37.5 | 300 | 27 | ≥50                                       | CNM. 1204..                                 | ATK-02                                     | AKV-30-M6x22                                 | AACN-3-0001                 | AAV-02-M5x12  | AS-01                   | ABPL-01              | AAL-03-3                                     |
| new                    | ○   | ● | 50   | 47   | 400 | 35 | ≥63                                       |   |  |  |                             |   |                         |                      |  |

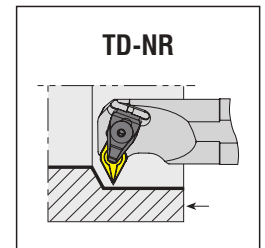
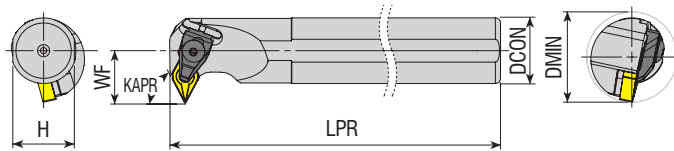

**Takım Kodu**  
**Ordering Code**  
**Bestell-Bezeichnung**

| Stok<br>Stock<br>Lager | Takım Ölçüleri (mm)<br>Dimension (mm)<br>Abmessung (mm) |   |      |      |     |    | Kesici Uç<br>Insert<br>Wendeschneidplatte | Yedek Parçaları / Spare Parts / Ersatzteile |  |  |                             |   |                         |                      |  |
|------------------------|---|---|------|------|-----|----|---|---|--|--|-----------------------------|---|-------------------------|----------------------|--|
|                        | R   | L | DCON | H    | LPR | WF |   | DMIN  | Baskı Pabucu<br>Wedge Clamp<br>Spannpratze | Pabuç Vidası<br>Clamp Screw<br>Klemmschraube | Altlık<br>Shim<br>Unterlage | Altlık Vidası<br>Shim Screw<br>Schraube für Unterlage | Segman<br>Ring<br>Feder | Pul<br>Stamp<br>Ring | Anahtar<br>Allen Key<br>Innerschloßschlüssel |
|                        | ●   | ● | 32   | 30   | 300 | 26 | ≥44                                       |   |  |  |                             |   |                         |                      |  |
|                        | ●   | ● | 40   | 37.5 | 350 | 29 | ≥52                                       | DNM. 1506..                                 | ATK-02                                     | AKV-30-M6x22                                 | AADN-3-0001                 | AAV-02-M5x12  | AS-01                   | ABPL-01              | AAL-03-3                                     |
|                        | ●   | ● | 50   | 47   | 400 | 35 | ≥63                                       |   |  |  |                             |   |                         |                      |  |

R: Sağ / Right / Rechts L: Sol / Left / Links  
● Stokta / In Stock / Auf Lager ○ Stokta Yok / Non Stock Item / Kein Lagerartikel, Lieferzeit auf Anfrage

Sipariş Örneği/Ordering Example/Bestellbeispiel  
1 ad./pcs./stück S25S TCLNR 09

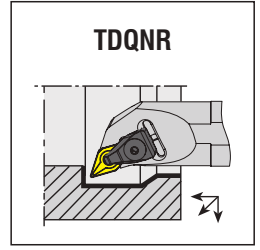
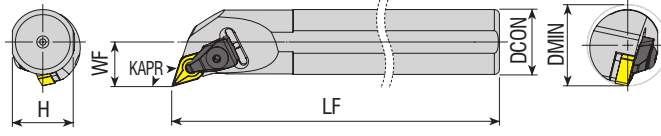

| Takım Kodu<br>Ordering Code<br>Bestell-Bezeichnung | Stok<br>Stock<br>Lager |   | Takım Ölçüleri (mm)<br>Dimension (mm)<br>Abmessung (mm) |      |     |    |      | Kesici Uç<br>Insert<br>Wendeschneidplatte | Baskı Pabucu<br>Wedge Clamp<br>Spannpratze | Pabuç Vidası<br>Clamp Screw<br>Klemmschraube | Yedek Parçaları / Spare Parts / Ersatzteile |   |                         |                      |   |  |  |
|--|------------------------|---|---|------|-----|----|------|---|--|--|---|---|-------------------------|----------------------|---|--|--|
|  | R                      | L | DCON  | H    | LF  | WF | DMIN |   |  |  | Altlık<br>Shim<br>Unterlage                 | Altlık Vidası<br>Shim Screw<br>Schraube für Unterlage | Segman<br>Ring<br>Feder | Pul<br>Stamp<br>Ring | Anahtar<br>Allen Key<br>Innensechskantschlüssel |  |  |
| S25S TDQNR/L 11                                    | ●                      | ● | 25  | 23   | 250 | 17 | ≥32  | DNM. 1104..                               | ATK-01                                     | AKV-01-M5x22                                 | AADN-2-0001                                 | AAV-09-M5x9   | -                       | ABPL-01              | AAL-03-3  |  |  |
| S32T TDQNR/L 11                                    | ●                      | ● | 32  | 30   | 300 | 22 | ≥40  |   |  |  |   | AAV-04-M5x12  |                         |                      |   |  |  |
| S25S TDQNR/L 15                                    | ●                      | ● | 25  | 23   | 250 | 17 | ≥32  | DNM. 1506..                               | ATK-02                                     | AKV-30-M6x22                                 | AADN-3-0001                                 | AAV-13-M5x8   | AS-01                   | ABPL-01              | AAL-03-3  |  |  |
| S32T TDQNR/L 15                                    | ●                      | ● | 32  | 30   | 300 | 22 | ≥40  |   |  |  |   | AAV-02-M5x12  |                         |                      |   |  |  |
| S40U TDQNR/L 15                                    | ●                      | ● | 40  | 37.5 | 350 | 27 | ≥50  |   |  |  |   |   |                         |                      |   |  |  |
| S50V TDQNR/L 15                                    | ●                      | ● | 50  | 47   | 400 | 35 | ≥63  |   |  |  |   |   |                         |                      |   |  |  |

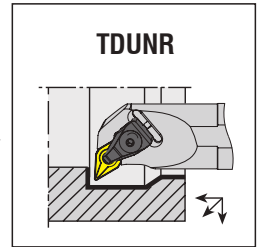
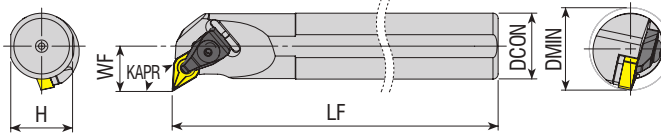

| Takım Kodu<br>Ordering Code<br>Bestell-Bezeichnung | Stok<br>Stock<br>Lager |   | Takım Ölçüleri (mm)<br>Dimension (mm)<br>Abmessung (mm) |      |     |    |      | Kesici Uç<br>Insert<br>Wendeschneidplatte | Baskı Pabucu<br>Wedge Clamp<br>Spannpratze | Pabuç Vidası<br>Clamp Screw<br>Klemmschraube | Yedek Parçaları / Spare Parts / Ersatzteile |   |                         |                      |   |  |  |
|--|------------------------|---|---|------|-----|----|------|---|--|--|---|---|-------------------------|----------------------|---|--|--|
|  | R                      | L | DCON  | H    | LF  | WF | DMIN |   |  |  | Altlık<br>Shim<br>Unterlage                 | Altlık Vidası<br>Shim Screw<br>Schraube für Unterlage | Segman<br>Ring<br>Feder | Pul<br>Stamp<br>Ring | Anahtar<br>Allen Key<br>Innensechskantschlüssel |  |  |
| S25S TDUNR/L 11                                    | ●                      | ● | 25  | 23   | 250 | 17 | ≥32  | DNM. 1104..                               | ATK-01                                     | AKV-01-M5x22                                 | AADN-2-0001                                 | AAV-09-M5x9   | -                       | ABPL-01              | AAL-03-3  |  |  |
| S32T TDUNR/L 11                                    | ●                      | ● | 32  | 30   | 300 | 22 | ≥40  |   |  |  |   | AAV-04-M5x12  |                         |                      |   |  |  |
| S25S TDUNR/L 15                                    | ●                      | ● | 25  | 23   | 250 | 17 | ≥34  | DNM. 1506..                               | ATK-02                                     | AKV-30-M6x22                                 | AADN-3-0001                                 | AAV-13-M5x8   | AS-01                   | ABPL-01              | AAL-03-3  |  |  |
| S32T TDUNR/L 15                                    | ●                      | ● | 32  | 30   | 300 | 22 | ≥40  |   |  |  |   | AAV-02-M5x12  |                         |                      |   |  |  |
| S40U TDUNR/L 15                                    | ●                      | ● | 40  | 37.5 | 350 | 27 | ≥50  |   |  |  |   |   |                         |                      |   |  |  |
| S50V TDUNR/L 15                                    | ●                      | ● | 50  | 47   | 400 | 35 | ≥63  |   |  |  |   |   |                         |                      |   |  |  |
| <b>new</b> A40T TDUNR/L 15                         | ●                      | ● | 40  | 37.5 | 300 | 27 | ≥50  |   |  |  |   |   |                         |                      |   |  |  |

R: Sağ / Right / Rechts L: Sol / Left / Links

● Stokta / In Stock / Auf Lager ○ Stokta Yok / Non Stock Item / Kein Lagerartikel, Lieferzeit auf Anfrage

Sipariş Örneği/Ordering Example/Bestellbeispiel

1 ad./pcs./stück S25S TDQNR 11

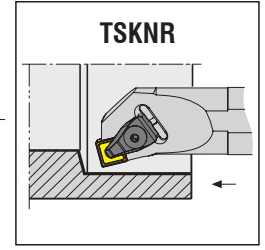
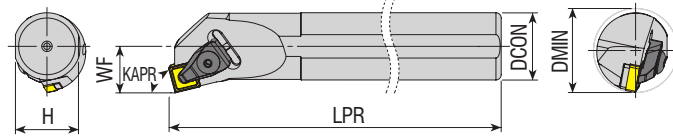

| Takım Kodu<br>Ordering Code<br>Bestell-Bezeichnung | Stok<br>Stock<br>Lager |   | Takım Ölçüleri (mm)<br>Dimension (mm)<br>Abmessung (mm) |      |     |    |      | Kesici Uç<br>Insert<br>Wendeschneidplatte | Yedek Parçaları / Spare Parts / Ersatzteile |  |                            |  |                         |                      |   |
|--|------------------------|---|---|------|-----|----|------|---|---|--|----------------------------|--|-------------------------|----------------------|---|
|  | R                      | L | DCON  | H    | LPR | WF | DMIN |   | Baskı Pabucu<br>Wedge Clamp<br>Spannpratze  | Pabuç Vidası<br>Clamp Screw<br>Klemmschraube | Altık<br>Shim<br>Unterlage | Altık Vidası<br>Shim Screw<br>Schraube für Unterlage | Segman<br>Ring<br>Feder | Pul<br>Stamp<br>Ring | Anahtar<br>Allen Key<br>Innensechskantschlüssel |
| S25S TSKNR/L 12                                    | ●                      | ● | 25  | 23   | 250 | 17 | ≥32  | SNM. 1204..                               |   | AKV-30-M6x22                                 | AASN -3-0004               | AAV-13-M5x8  | AS-01                   | ABPL-01              | AAL-03-3  |
| S32T TSKNR/L 12                                    | ●                      | ● | 32  | 30   | 300 | 22 | ≥40  |   |   |  |                            |  |                         |                      |   |
| S40U TSKNR/L 12                                    | ●                      | ● | 40  | 37.5 | 350 | 27 | ≥50  |   |   |  |                            |  |                         |                      |   |

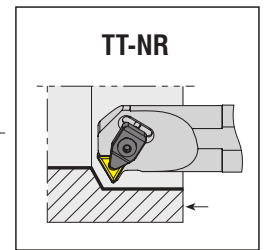
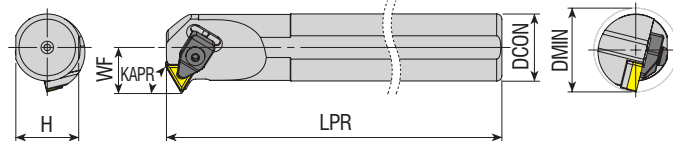

| Takım Kodu<br>Ordering Code<br>Bestell-Bezeichnung | Stok<br>Stock<br>Lager |   | Takım Ölçüleri (mm)<br>Dimension (mm)<br>Abmessung (mm) |    |     |    |      | Kesici Uç<br>Insert<br>Wendeschneidplatte | Yedek Parçaları / Spare Parts / Ersatzteile |  |                            |  |                          |                      |   |
|--|------------------------|---|---|----|-----|----|------|---|---|--|----------------------------|--|--------------------------|----------------------|---|
|  | R                      | L | DCON  | H  | LPR | WF | DMIN |   | Baskı Pabucu<br>Wedge Clamp<br>Spannpratze  | Pabuç Vidası<br>Clamp Screw<br>Klemmschraube | Altık<br>Shim<br>Unterlage | Altık Vidası<br>Shim Screw<br>Schraube für Unterlage | Yay<br>Spring<br>Пружина | Pul<br>Stamp<br>Ring | Anahtar<br>Allen Key<br>Innensechskantschlüssel |
| S25S TT-NR/L 16                                    | ●                      | ● | 25  | 23 | 250 | 17 | ≥32  | TNM. 1604..                               |   | AKV-01-M5x22                                 | AATN-2-0002                | AAV-03-M5x12   | -                        | ABPL-01              | AAL-03-3  |
| S32T TT-NR/L 16                                    | ●                      | ● | 32  | 30 | 300 | 22 | ≥40  |   |   |  |                            |  |                          |                      |   |

R: Sağ / Right / Rechts L: Sol / Left / Links  
● Stokta / In Stock / Auf Lager ○ Stokta Yok / Non Stock Item / Kein Lagerartikel, Lieferzeit auf Anfrage

Sipariş Örneği/Ordering Example/Bestellbeispiel  
1 ad./pcs./stück S25S TSKNR 12

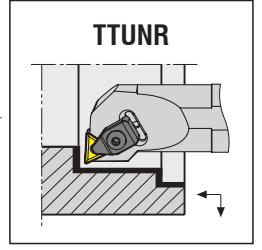
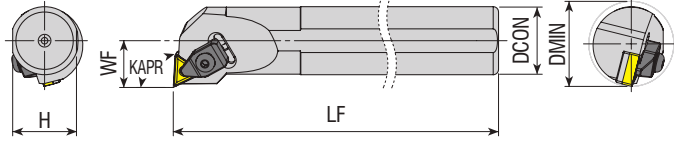

| Takım Kodu<br>Ordering Code<br>Bestell-Bezeichnung | Stok<br>Stock<br>Lager |   | Takım Ölçüleri (mm)<br>Dimension (mm)<br>Abmessung (mm) |      |     |    |      | Kesici Uç<br>Insert<br>Wendeschneidplatte | Yedek Parçaları / Spare Parts / Ersatzteile |  |                             |   |                         |                      |   |
|--|------------------------|---|---|------|-----|----|------|---|---|--|-----------------------------|---|-------------------------|----------------------|---|
|  | R                      | L | DCON  | H    | LF  | WF | DMIN |   | Baskı Pabucu<br>Wedge Clamp<br>Spannpratze  | Pabuç Vidası<br>Clamp Screw<br>Klemmschraube | Altlık<br>Shim<br>Unterlage | Altlık Vidası<br>Shim Screw<br>Schraube für Unterlage | Segman<br>Ring<br>Feder | Pul<br>Stamp<br>Ring | Anahtar<br>Allen Key<br>Innensechskantschlüssel |
| S25S TTUNR/L 16                                    | ●                      | ● | 25  | 23   | 250 | 17 | ≥32  | TNM. 1604..                               | ATK-01                                      | AKV-01-M5x22                                 | AATN-2-0002                 | AAV-03-M5x12  | -                       | ABPL-01              | AAL-03-3  |
| S32T TTUNR/L 16                                    | ●                      | ● | 32  | 30   | 300 | 22 | ≥40  |   |   |  |                             |   |                         |                      |   |
| S25S TTUNR/L 22                                    | ●                      | ● | 25  | 23   | 250 | 17 | ≥32  | TNM. 2204..                               | ATK-02                                      | AKV-30-M6x22                                 | AATN-3-0015                 | AAV-02-M5x12  | AS-01                   | ABPL-01              | AAL-03-3  |
| S32T TTUNR/L 22                                    | ●                      | ● | 32  | 30   | 300 | 22 | ≥40  |   |   |  |                             |   |                         |                      |   |
| S40U TTUNR/L 22                                    | ●                      | ● | 40  | 37.5 | 350 | 27 | ≥50  |   |   |  |                             |   |                         |                      |   |
| S50V TTUNR/L 22                                    | ●                      | ● | 50  | 47   | 400 | 35 | ≥63  |   |   |  |                             |   |                         |                      |   |

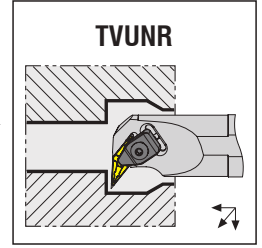
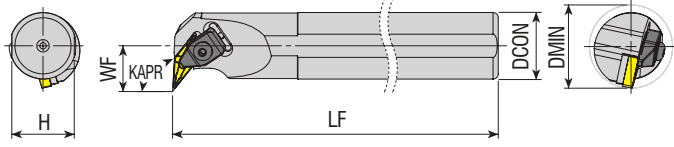

| Takım Kodu<br>Ordering Code<br>Bestell-Bezeichnung | Stok<br>Stock<br>Lager |   | Takım Ölçüleri (mm)<br>Dimension (mm)<br>Abmessung (mm) |      |     |    |      | Kesici Uç<br>Insert<br>Wendeschneidplatte | Yedek Parçaları / Spare Parts / Ersatzteile |  |                             |   |                          |                      |   |
|--|------------------------|---|---|------|-----|----|------|---|---|--|-----------------------------|---|--------------------------|----------------------|---|
|  | R                      | L | DCON  | H    | LF  | WF | DMIN |   | Baskı Pabucu<br>Wedge Clamp<br>Spannpratze  | Pabuç Vidası<br>Clamp Screw<br>Klemmschraube | Altlık<br>Shim<br>Unterlage | Altlık Vidası<br>Shim Screw<br>Schraube für Unterlage | Yay<br>Spring<br>Пружина | Pul<br>Stamp<br>Ring | Anahtar<br>Allen Key<br>Innensechskantschlüssel |
| S25S TVUNR/L 16                                    | ●                      | ● | 25  | 23   | 250 | 20 | ≥36  | VNM. 1604..                               | ATK-01                                      | AKV-01-M5x22                                 | AAVN-2-0002                 | AAV-04-M5x12  | -                        | ABPL-01              | AAL-03-3  |
| S32T TVUNR/L 16                                    | ●                      | ● | 32  | 30   | 300 | 22 | ≥40  |   |   |  |                             |   |                          |                      |   |
| S40U TVUNR/L 16                                    | ●                      | ● | 40  | 37.5 | 350 | 27 | ≥50  |   |   |  |                             |   |                          |                      |   |

R: Sağ / Right / Rechts L: Sol / Left / Links

● Stokta / In Stock / Auf Lager ○ Stokta Yok / Non Stock Item / Kein Lagerartikel, Lieferzeit auf Anfrage

Sipariş Örneği/Ordering Example/Bestellbeispiel

1 ad./pcs./stück S25S TTUNR 16



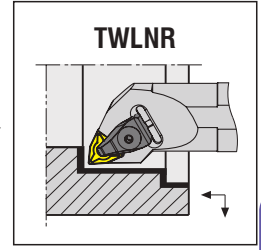
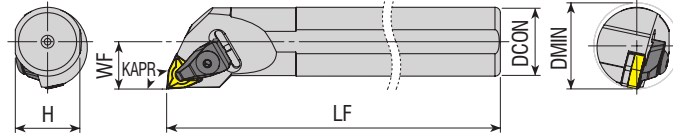

**Takım Kodu**  
**Ordering Code**  
*Bestell-Bezeichnung*

| Takım Kodu<br>Ordering Code<br>Bestell-Bezeichnung | Stok<br>Stock<br>Lager |   | Takım Ölçüleri (mm)<br>Dimension (mm)<br>Abmessung (mm) |      |     |    |      | Kesici Uç<br>Insert<br>Wendeschneidplatte | Baskı Pabucu<br>Wedge Clamp<br>Spannpratze | Pabuç Vidası<br>Clamp Screw<br>Klemmschraube | Altlık<br>Shim<br>Unterlage | Altlık Vidası<br>Shim Screw<br>Schraube für Unterlage | Segman<br>Ring<br>Feder | Pul<br>Stamp<br>Ring | Anahtar<br>Allen Key<br>Innensechskantschlüssel |
|--|------------------------|---|---|------|-----|----|------|---|--|--|-----------------------------|---|-------------------------|----------------------|---|
|  | R                      | L | DCON  | H    | LF  | WF | DMIN |   |  |  |                             |   |                         |                      |   |
| S25S TWLNR/L 06                                    | ●                      | ● | 25  | 23   | 250 | 17 | ≥32  | WNM. 0604..                               | ATK-01                                     | AKV-01-M5x22                                 | AAWN-SW317                  | AAV-01-M3x10  | -                       |                      |   |
| S32T TWLNR/L 06                                    | ●                      | ● | 32  | 30   | 300 | 22 | ≥40  |   |  |  |                             | AAV-13-M5x8   |                         |                      |   |
| S25S TWLNR/L 08                                    | ●                      | ● | 25  | 23   | 250 | 17 | ≥32  | WNM. 0804..                               | ATK-02                                     | AKV-30-M6x22                                 | AAWN-3-0001                 | AAV-02-M5x12  | AS-01                   | ABPL-01              | AAL-03-3  |
| S32T TWLNR/L 08                                    | ●                      | ● | 32  | 30   | 300 | 22 | ≥40  |   |  |  |                             |   |                         |                      |   |
| S40U TWLNR/L 08                                    | ●                      | ● | 40  | 37.5 | 350 | 27 | ≥50  |   |  |  |                             |   |                         |                      |   |
| S50V TWLNR/L 08                                    | ●                      | ● | 50  | 47   | 400 | 35 | ≥63  |   |  |  |                             |   |                         |                      |   |
| A40T TWLNR/L 08                                    | ●                      | ○ | 40  | 37.5 | 300 | 27 | ≥50  |   |  |  |                             |   |                         |                      |   |
| A50U TWLNR/L 08                                    | ●                      | ○ | 50  | 47   | 350 | 35 | ≥63  |   |  |  |                             |   |                         |                      |   |

Yedek Parçaları / Spare Parts / Ersatzteile

**C-SİSTEM DELİK TORNA KATERLERİ**  
**C-SYSTEM BORING BARS**  
**C-SYSTEM BOHRSTANGE**

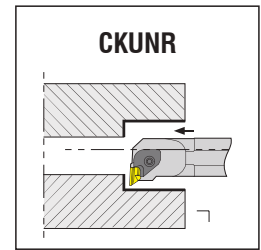
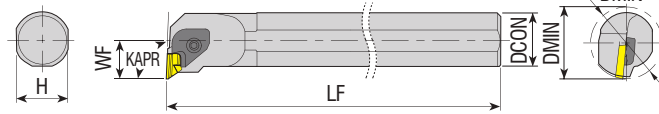

**Takım Kodu**  
**Ordering Code**  
*Bestell-Bezeichnung*

| Takım Kodu<br>Ordering Code<br>Bestell-Bezeichnung | Stok<br>Stock<br>Lager |   | Takım Ölçüleri (mm)<br>Dimension (mm)<br>Abmessung (mm) |      |     |    |      | Kesici Uç<br>Insert<br>Wendeschneidplatte | Baskı Pabucu<br>Wedge Clamp<br>Spannpratze | Pabuç Vidası<br>Clamp Screw<br>Klemmschraube | Altlık<br>Shim<br>Unterlage | Altlık Vidası<br>Shim Screw<br>Schraube für Unterlage | Yay<br>Spring<br>Пружина | Pul<br>Stamp<br>Ring | Anahtar<br>Allen Key<br>Innensechskantschlüssel |
|--|------------------------|---|---|------|-----|----|------|---|--|--|-----------------------------|---|--------------------------|----------------------|---|
|  | R                      | L | DCON  | H    | LF  | WF | DMIN |   |  |  |                             |   |                          |                      |   |
| S25S CKUNR/L 16                                    | ●                      | ● | 25  | 23   | 250 | 19 | ≥38  | KNUX 1604..                               | ACK-01-R<br>ACK-02-L                       | AKV-06-M6x20                                 | AKS-16-R<br>AKS-16-L        | AAV-01-M3x10  | AKY-02                   | ABPL-01              | AAL-05-4  |
| S32T CKUNR/L 16                                    | ●                      | ● | 32  | 30   | 300 | 22 | ≥40  |   |  |  |                             |   |                          |                      |   |
| S40U CKUNR/L 16                                    | ●                      | ● | 40  | 37.5 | 350 | 27 | ≥50  |   |  |  |                             |   |                          |                      |   |
| S50V CKUNR/L 16                                    | ●                      | ● | 50  | 47   | 400 | 35 | ≥63  |   |  |  |                             |   |                          |                      |   |

Yedek Parçaları / Spare Parts / Ersatzteile

R: Sağ / Right / Rechts L: Sol / Left / Links  
● Stokta / In Stock / Auf Lager ○ Stokta Yok / Non Stock Item / Kein Lagerartikel, Lieferzeit auf Anfrage

Sipariş Örneği/Ordering Example/Bestellbeispiel  
1 ad./pcs./stück S25S TWLNR 06

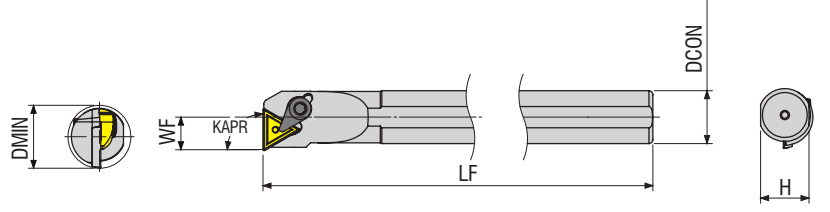

**Takım Kodu**  
**Ordering Code**  
**Bestell-Bezeichnung**

| Stok<br>Stock<br>Lager | Takım Ölçüleri (mm)<br>Dimension (mm)<br>Abmessung (mm) |   |      |      |     |    | Kesici Uç<br>Insert<br>Wendeschneidplatte | Yedek Parçaları / Spare Parts / Ersatzteile |  |  |                             |   |                         |                      |   |
|------------------------|---|---|------|------|-----|----|---|---|--|--|-----------------------------|---|-------------------------|----------------------|---|
|                        | R   | L | DCON | H    | LF  | WF |   | DMIN  | Baskı Pabuçu<br>Wedge Clamp<br>Spannpratze | Pabuç Vidası<br>Clamp Screw<br>Klemmschraube | Altlık<br>Shim<br>Unterlage | Altlık Vidası<br>Shim Screw<br>Schraube für Unterlage | Segman<br>Ring<br>Feder | Pul<br>Stamp<br>Ring | Anahtar<br>Allen Key<br>Innerschlitzschlüssel |
| ● ○                    |   |   | 16   | 14.7 | 200 | 11 | 22  | <b>TP.. 1603..</b>                          |  |  |                             |   |                         |                      |   |
| ● ○                    |   |   | 20   | 18.3 | 250 | 13 | 24  |   |  |  |                             |   |                         |                      |   |
| ● ○                    |   |   | 25   | 23   | 300 | 17 | 32  |   |  |  |                             |   |                         |                      |   |

R: Sağ / Right / Rechts L: Sol / Left / Links  
● Stokta / In Stock / Auf Lager ○ Stokta Yok / Non Stock Item / Kein Lagerartikel, Lieferzeit auf Anfrage

Sipariş Örneği/Ordering Example/Bestellbeispiel  
1 ad./pcs./stück S16R CTFPR 16



# M-SİSTEM

M-SİSTEM DELİK TORNA KATERLERİ  
M-SYSTEM BORING BARS  
M-SYSTEM BOHRSTANGE

*konusulan*  
*the spoken kalite...*  
*quality...*



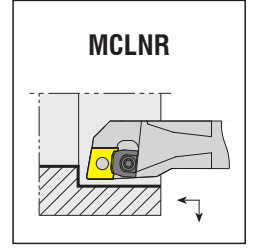
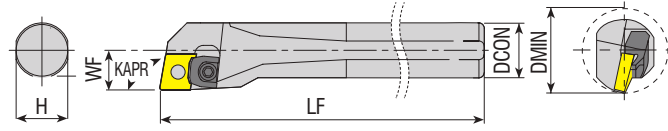

| Takım Kodu<br>Ordering Code<br>Bestell-Bezeichnung | Stok<br>Stock<br>Lager |   | Takım Ölçüleri (mm)<br>Dimension (mm)<br>Abmessung (mm) |      |     |    |      | Kesici Uç<br>Insert<br>Wendeschneidplatte | Baskı Pabucu<br>Wedge Clamp<br>Spannpratze | Pabuç Vidası<br>Clamp Screw<br>Klemmschraube | Altlık<br>Shim<br>Unterlage | Pim<br>Pin<br>Штифт | Pul<br>Stamp<br>Ring | Anahtar<br>Allen Key<br>Innensechskantschlüssel |
|--|------------------------|---|---|------|-----|----|------|---|--|--|-----------------------------|---------------------|----------------------|---|
|  | R                      | L | DCON  | H    | LF  | WF | DMIN |   |  |  |                             |                     |                      |   |
| <b>S20R MCLNR/L 12</b>                             | ●                      | ● | 20  | 18.3 | 200 | 13 | ≥25  | CNM. 1204..                               | AMK-07                                     | AKV-04-M5x17                                 | -                           | APM-12              | -                    | AAL-03-3  |
| <b>S25S MCLNR/L 12</b>                             | ●                      | ● | 25  | 23   | 250 | 17 | ≥32  |   | AMK-03                                     |  | AACN-3-0001                 | APM-13              |                      |   |
| <b>S32T MCLNR/L 12</b>                             | ●                      | ● | 32  | 30   | 300 | 22 | ≥40  |   |  |  |                             | APM-04              |                      |   |

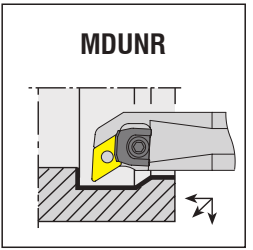
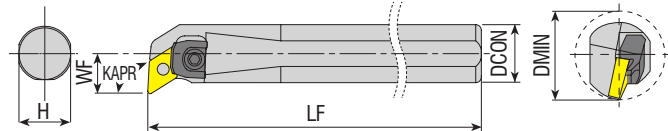

| Takım Kodu<br>Ordering Code<br>Bestell-Bezeichnung | Stok<br>Stock<br>Lager |   | Takım Ölçüleri (mm)<br>Dimension (mm)<br>Abmessung (mm) |      |     |    |      | Kesici Uç<br>Insert<br>Wendeschneidplatte | Baskı Pabucu<br>Wedge Clamp<br>Spannpratze | Pabuç Vidası<br>Clamp Screw<br>Klemmschraube | Altlık<br>Shim<br>Unterlage | Pim<br>Pin<br>Штифт | Segman<br>Ring<br>Feder | Pul<br>Stamp<br>Ring | Anahtar<br>Allen Key<br>Innensechskantschlüssel |
|--|------------------------|---|---|------|-----|----|------|---|--|--|-----------------------------|---------------------|-------------------------|----------------------|---|
|  | R                      | L | DCON  | H    | LF  | WF | DMIN |   |  |  |                             |                     |                         |                      |   |
| <b>S20R MDUNR/L 11</b>                             | ●                      | ● | 20  | 18.3 | 200 | 13 | ≥25  | DNM. 1104..                               | AMK-03                                     | AKV-17-M5x15                                 | -                           | APM-03              | -                       | -                    | AAL-03-3  |
| <b>S25S MDUNR/L 11</b>                             | ●                      | ● | 25  | 23   | 250 | 17 | ≥32  |   |  | AKV-04-M5x17                                 |                             |                     |                         |                      |   |
| <b>S32T MDUNR/L 11</b>                             | ○                      | ○ | 32  | 30   | 300 | 22 | ≥40  |   |  |  |                             |                     |                         |                      |   |
| <b>S25S MDUNR/L 15</b>                             | ●                      | ● | 25  | 23   | 250 | 17 | ≥32  | DNM. 1506..                               | AMK-04                                     | AKV-20-M6x19                                 | AADN-3-0001                 | APM-04              | AS-01                   | ABPL-01              |   |
| <b>S32T MDUNR/L 15</b>                             | ●                      | ● | 32  | 30   | 300 | 22 | ≥40  |   |  |  |                             |                     |                         |                      |   |
| <b>S40U MDUNR/L 15</b>                             | ●                      | ● | 40  | 37.5 | 350 | 27 | ≥50  |   |  |  |                             |                     |                         |                      |   |
| <b>S50V MDUNR/L 15</b>                             | ●                      | ● | 50  | 47   | 400 | 35 | ≥63  |   |  |  |                             |                     |                         |                      |   |

R: Sağ / Right / Rechts L: Sol / Left / Links  
● Stokta / In Stock / Auf Lager ○ Stokta Yok / Non Stock Item / Kein Lagerartikel, Lieferzeit auf Anfrage

Sipariş Örneği/Ordering Example/Bestellbeispiel  
1 ad./pcs./stück S20R MCLNR 12

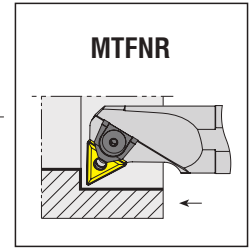
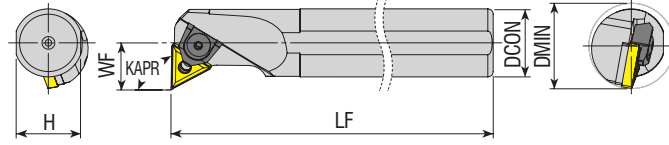

**Takım Kodu**  
**Ordering Code**  
**Bestell-Bezeichnung**

| Stok<br>Stock<br>Lager | Takım Ölçüleri (mm)<br>Dimension (mm)<br>Abmessung (mm) |    |      |     |    |     | Kesici Uç<br>Insert<br>Wendeschneidplatte | Baskı Pabucu<br>Wedge Clamp<br>Spannpratze | Pabuç Vidası<br>Clamp Screw<br>Klemmschraube | Yedek Parçaları / Spare Parts / Ersatzteile |                            |                     |                         |                      |
|------------------------|---|----|------|-----|----|-----|---|--|--|---|----------------------------|---------------------|-------------------------|----------------------|
|                        | R   | L  | DCON | H   | LF | WF  |   |  |  | DMIN  | Altık<br>Shim<br>Unterlage | Pim<br>Pin<br>Штифт | Segman<br>Ring<br>Feder | Pul<br>Stamp<br>Ring |
| ●●                     | ●●  | 20 | 18.3 | 200 | 14 | ≥25 | TNM. 1604..                               | AMK-02                                     | AKV-17-M5x15                                 | -   | APM-03                     | -                   | -                       | AAL-03-3             |
| ●●                     | ●●  | 25 | 23   | 250 | 17 | ≥32 |   |  |  | AATN-2-0002                                 | APM-14                     | AS-01               | ABPL-01                 |                      |
| ●●                     | ●●  | 32 | 30   | 300 | 22 | ≥40 |   |  |  | APM-01                                      | APM-02                     |                     |                         |                      |
| ●●                     | ●●  | 40 | 37.5 | 350 | 27 | ≥50 |   |  |  |   |                            |                     |                         |                      |
| ●●                     | ●●  | 32 | 30   | 300 | 22 | ≥40 | TNM. 2204..                               | AMK-04                                     | AKV-30-M6x22                                 | AATN-3-0015                                 | APM-02                     |                     |                         |                      |
| ●●                     | ●●  | 40 | 37.5 | 350 | 27 | ≥50 |   |  |  |   |                            |                     |                         |                      |
| ●○                     | ○   | 50 | 47   | 400 | 35 | ≥63 |   |  |  |   |                            |                     |                         |                      |

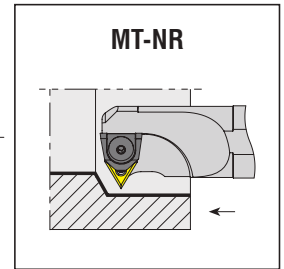
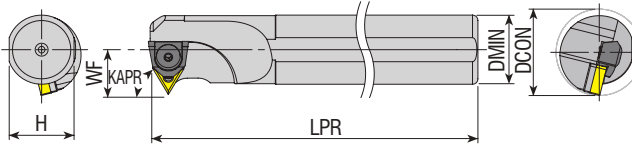

**Takım Kodu**  
**Ordering Code**  
**Bestell-Bezeichnung**

| Stok<br>Stock<br>Lager | Takım Ölçüleri (mm)<br>Dimension (mm)<br>Abmessung (mm) |    |      |     |     |     | Kesici Uç<br>Insert<br>Wendeschneidplatte | Baskı Pabucu<br>Wedge Clamp<br>Spannpratze | Pabuç Vidası<br>Clamp Screw<br>Klemmschraube | Yedek Parçaları / Spare Parts / Ersatzteile |                            |                     |                         |                      |
|------------------------|---|----|------|-----|-----|-----|---|--|--|---|----------------------------|---------------------|-------------------------|----------------------|
|                        | R   | L  | DCON | H   | LPR | WF  |   |  |  | DMIN  | Altık<br>Shim<br>Unterlage | Pim<br>Pin<br>Штифт | Segman<br>Ring<br>Feder | Pul<br>Stamp<br>Ring |
| ●●                     | ●●  | 20 | 18.3 | 200 | 16  | ≥26 | TNM. 1604..                               | AMK-02                                     | AKV-04-M5x17                                 | -   | APM-03                     | -                   | -                       | AAL-03-3             |
| ●●                     | ●●  | 25 | 23   | 250 | 17  | ≥32 |   |  |  | AATN-2-0002                                 | APM-14                     | AS-01               | ABPL-01                 |                      |
| ●●                     | ●●  | 32 | 30   | 300 | 22  | ≥40 |   |  |  | APM-01                                      | APM-02                     |                     |                         |                      |
| ●●                     | ●●  | 40 | 37.5 | 350 | 27  | ≥50 |   |  |  |   |                            |                     |                         |                      |
| ●●                     | ●●  | 32 | 30   | 300 | 24  | ≥40 | TNM. 2204..                               | AMK-04                                     | AKV-30-M6x22                                 | AATN-3-0015                                 | APM-02                     |                     |                         |                      |
| ●●                     | ●●  | 40 | 37.5 | 350 | 27  | ≥50 |   |  |  |   |                            |                     |                         |                      |
| ●●                     | ●●  | 50 | 47   | 350 | 35  | ≥63 |   |  |  |   |                            |                     |                         |                      |

R: Sağ / Right / Rechts L: Sol / Left / Links  
● Stokta / In Stock / Auf Lager ○ Stokta Yok / Non Stock Item / Kein Lagerartikel, Lieferzeit auf Anfrage

Sipariş Örneği/Ordering Example/Bestellbeispiel  
1 ad./pcs./stück S20R MTFNR 16

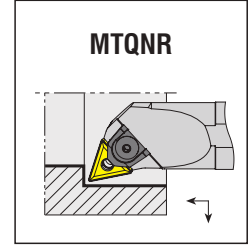
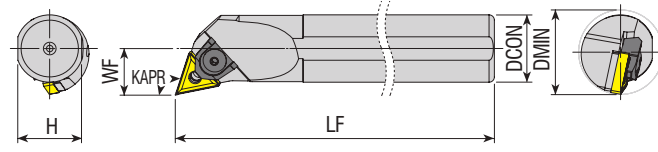

MTQNR

**Takım Kodu**  
**Ordering Code**  
**Bestell-Bezeichnung**

| Stok<br>Stock<br>Lager | Takım Ölçüleri (mm)<br>Dimension (mm)<br>Abmessung (mm) |   |      |   |    |    | Kesici Uç<br>Insert<br>Wendeschneidplatte | Baskı Pabucu<br>Wedge Clamp<br>Spannpratze | Pabuç Vidası<br>Clamp Screw<br>Klemmschraube | Altlık<br>Shim<br>Unterlage | Pim<br>Pin<br>Штифт | Segman<br>Ring<br>Feder | Pul<br>Stamp<br>Ring | Anahtar<br>Allen Key<br>Innensechskantschlüssel |          |
|------------------------|---|---|------|---|----|----|---|--|--|-----------------------------|---------------------|-------------------------|----------------------|---|----------|
|                        | R   | L | DCON | H | LF | WF |   |  |  |                             |                     |                         |                      |   | DMIN     |
|                        |   |   |      |   |    |    |   |  |  |                             |                     |                         |                      |   |          |
|                        |   |   |      |   |    |    | TNM. 1604..                               | AMK-02                                     | AKV-17-M5x15                                 | -                           | APM-11              | -                       | -                    |   |          |
|                        |   |   |      |   |    |    |   |  |  |                             |                     |                         |                      |   |          |
|                        |   |   |      |   |    |    |   |  |  |                             |                     |                         |                      |   |          |
|                        |   |   |      |   |    |    |   |  |  |                             |                     |                         |                      |   |          |
|                        |   |   |      |   |    |    | TNM. 2204..                               | AMK-04                                     | AKV-30-M6x22                                 | AATN-2-0002                 | APM-14              | APM-01                  | AS-01                | ABPL-01   | AAL-03-3 |
|                        |   |   |      |   |    |    |   |  |  |                             |                     |                         |                      |   |          |
|                        |   |   |      |   |    |    |   |  |  |                             |                     |                         |                      |   |          |
|                        |   |   |      |   |    |    |   |  |  |                             |                     |                         |                      |   |          |
|                        |   |   |      |   |    |    |   |  |  |                             |                     |                         |                      |   |          |

Yedek Parçaları / Spare Parts / Ersatzteile

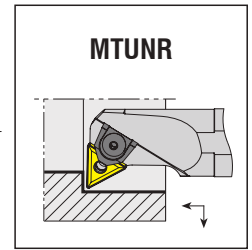
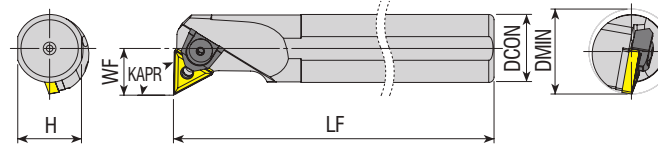

MTUNR

**Takım Kodu**  
**Ordering Code**  
**Bestell-Bezeichnung**

| Stok<br>Stock<br>Lager | Takım Ölçüleri (mm)<br>Dimension (mm)<br>Abmessung (mm) |   |      |   |    |    | Kesici Uç<br>Insert<br>Wendeschneidplatte | Baskı Pabucu<br>Wedge Clamp<br>Spannpratze | Pabuç Vidası<br>Clamp Screw<br>Klemmschraube | Altlık<br>Shim<br>Unterlage | Pim<br>Pin<br>Штифт | Segman<br>Ring<br>Feder | Pul<br>Stamp<br>Ring | Anahtar<br>Allen Key<br>Innensechskantschlüssel |          |
|------------------------|---|---|------|---|----|----|---|--|--|-----------------------------|---------------------|-------------------------|----------------------|---|----------|
|                        | R   | L | DCON | H | LF | WF |   |  |  |                             |                     |                         |                      |   | DMIN     |
|                        |   |   |      |   |    |    |   |  |  |                             |                     |                         |                      |   |          |
|                        |   |   |      |   |    |    | TNM. 1604..                               | AMK-02                                     | AKV-17-M5x15                                 | -                           | APM-03              | -                       | -                    |   |          |
|                        |   |   |      |   |    |    |   |  |  |                             |                     |                         |                      |   |          |
|                        |   |   |      |   |    |    |   |  |  |                             |                     |                         |                      |   |          |
|                        |   |   |      |   |    |    |   |  |  |                             |                     |                         |                      |   |          |
|                        |   |   |      |   |    |    | TNM. 2204..                               | AMK-04                                     | AKV-30-M6x22                                 | AATN-2-0002                 | APM-14              | APM-01                  | AS-01                | ABPL-01   | AAL-03-3 |
|                        |   |   |      |   |    |    |   |  |  |                             |                     |                         |                      |   |          |
|                        |   |   |      |   |    |    |   |  |  |                             |                     |                         |                      |   |          |
|                        |   |   |      |   |    |    |   |  |  |                             |                     |                         |                      |   |          |
|                        |   |   |      |   |    |    |   |  |  |                             |                     |                         |                      |   |          |

Yedek Parçaları / Spare Parts / Ersatzteile

R: Sağ / Right / Rechts L: Sol / Left / Links

● Stokta / In Stock / Auf Lager ○ Stokta Yok / Non Stock Item / Kein Lagerartikel, Lieferzeit auf Anfrage

Sipariş Örneği/Ordering Example/Bestellbeispiel

1 ad./pcs./stück S20R MTQNR 16

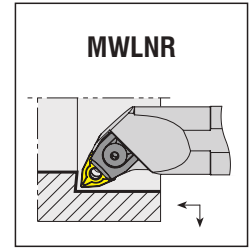
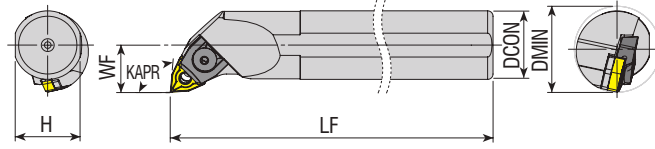

**Takım Kodu**  
**Ordering Code**  
*Bestell-Bezeichnung*

| Stok<br>Stock<br>Lager | Takım Ölçüleri (mm)<br>Dimension (mm)<br>Abmessung (mm) |   |      |      |     |    | Kesici Uç<br>Insert<br>Wendeschneidplatte | Baskı Pabucu<br>Wedge Clamp<br>Spannpratze | Pabuç Vidası<br>Clamp Screw<br>Klemmschraube | Yedek Parçaları / Spare Parts / Ersatzteile |                            |                                      |                         |                      |  |  |
|------------------------|---|---|------|------|-----|----|---|--|--|---|----------------------------|--------------------------------------|-------------------------|----------------------|--|--|
|                        | R   | L | DCON | H    | LF  | WF |   |  |  | DMIN  | Altık<br>Shim<br>Unterlage | Pim<br>Pin<br>Штифт                  | Segman<br>Ring<br>Feder | Pul<br>Stamp<br>Ring | Anahtar<br>Allen Key<br>Innenschlüssel |  |
|                        | ●   | ● | 16   | 14.8 | 170 | 11 | ≥20                                       | WNM. 0604..                                | AMK-01                                       | AKV-17-M5x15<br>AKV-04-M5x17                | -                          | APM-09<br>APM-10<br>APM-08<br>APM-04 | -                       | -                    |  |  |
|                        | ●   | ● | 20   | 18.3 | 200 | 13 | ≥25                                       |  |  |   |                            |                                      |                         |                      |  |  |
|                        | ●   | ● | 25   | 23   | 250 | 17 | ≥32                                       |  |  |   |                            |                                      |                         |                      |  |  |
|                        | ●   | ● | 25   | 23   | 250 | 17 | ≥32                                       | WNM. 0804..                                | AMK-05                                       | AKV-27-M6x20<br>AKV-03-M6x22                | AAWN-3-0001                | APM-02                               | AS-01                   | ABPL-01              | AAL-03-3                               |  |
| <b>new</b>             | ●   | ● | 20   | 18.3 | 200 | 13 | ≥25                                       |  |  |   |                            |                                      |                         |                      |  |  |
|                        | ●   | ● | 32   | 30   | 300 | 22 | ≥40                                       |  |  |   |                            |                                      |                         |                      |  |  |
|                        | ●   | ● | 40   | 37.5 | 350 | 27 | ≥50                                       |  |  |   |                            |                                      |                         |                      |  |  |

R: Sağ / Right / Rechts L: Sol / Left / Links  
● Stokta / In Stock / Auf Lager ○ Stokta Yok / Non Stock Item / Kein Lagerartikel, Lieferzeit auf Anfrage

Sipariş Örneği/Ordering Example/Bestellbeispiel  
1 ad./pcs./stück S16P MWLNR 06





*konusulan  
the spoken kalite...  
quality...*

# P-SİSTEM

**P-SİSTEM DELİK TORNA KATERLERİ**  
*P-SYSTEM BORING BARS*  
*P-SYSTEM BOHRSTANGE*





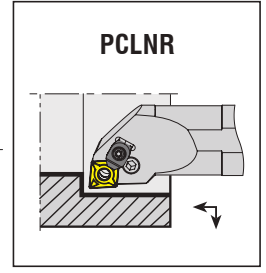
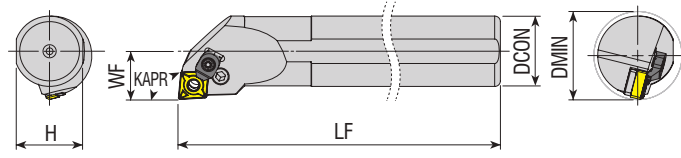

| Takım Kodu<br>Ordering Code<br>Bestell-Bezeichnung | Stok<br>Stock<br>Lager |   | Takım Ölçüleri (mm)<br>Dimension (mm)<br>Abmessung (mm) |      |     |    | Kesici Uç<br>Insert<br>Wendeschneidplatte | Yedek Parçaları / Spare Parts / Ersatzteile |                               |  |                            |   |  |  |   |
|--|------------------------|---|---|------|-----|----|---|---|-------------------------------|--|----------------------------|---|--|--|---|
|  | R                      | L | DCON  | H    | LF  | WF |   | DMIN  | Levyeye<br>Lever<br>Kniehebel | Levyeye Vidası<br>Lever Screw<br>Kniehebelschraube | Altık<br>Shim<br>Unterlage | Altık Yay<br>Shim Spring<br>Feder für Unterlage | Baskı Pabucu<br>Wedge Clamp<br>Spannpratze | Pabuç Vidası<br>Clamp Screw<br>Klemmschraube | Anahtar<br>Allen Key<br>Innensechskantschlüssel |
| S16P PCLNR/L 09                                    | ●                      | ● | 16  | 14.8 | 170 | 11 | ≥20                                       | CNM. 0903..                                 | APL-07                        | ALV-07-M6x13                                       | -                          | AAY-07  | -  | -  | AAL-02-2.5                                      |
| S20R PCLNR/L 09                                    | ●                      | ● | 20  | 18.3 | 200 | 13 | ≥25                                       |   | APL-01                        | ALV-01-M6x14                                       | AACN-2-0002                | AAY-01  | -  | -  | AAL-02-2.5                                      |
| S25S PCLNR/L 09                                    | ●                      | ○ | 25  | 23   | 250 | 17 | ≥32                                       | CNM. 1204..                                 | APL-02                        | ALV-08-M8x16                                       | AACN-3-0001                | AAY-02  | ACK-05                                     | 4015-M4x11                                   | AAL-03-3  |
| S25S PCLNR/L 12C                                   | ●                      | ● | 25  | 23   | 250 | 17 | ≥32                                       |   |                               | ALV-03-M8x19                                       |                            |   |  |  |   |
| S32T PCLNR/L 12C                                   | ●                      | ● | 32  | 30   | 300 | 22 | ≥40                                       | CNM. 1606..                                 | APL-04                        | ALV-04-M8x22                                       | AACN-3-0002                | AAY-03  | ACK-09                                     | AAV-05-M6x15                                 | AAL-05-4  |
| S40U PCLNR/L 12C                                   | ●                      | ● | 40  | 37.5 | 350 | 27 | ≥50                                       |   |                               |  |                            |   |  |  |   |
| S50V PCLNR/L 12C                                   | ●                      | ● | 50  | 47   | 400 | 35 | ≥63                                       | CNM. 1906..                                 | APL-05                        | ALV-05-M10x27                                      | AACN-3-0003                | AAY-04  | ACK-09                                     | AAV-05-M6x15                                 | AAL-05-4  |
| S32T PCLNR/L 16C                                   | ●                      | ● | 32  | 30   | 300 | 22 | ≥40                                       |   |                               |  |                            |   |  |  |   |
| S40U PCLNR/L 16C                                   | ●                      | ● | 40  | 37.5 | 350 | 27 | ≥50                                       | CNM. 0903..                                 | APL-01                        | ALV-01-M6x17                                       | AACN-2-0002                | AAY-01  | -  | -  | AAL-02-2.5                                      |
| S50V PCLNR/L 16C                                   | ●                      | ● | 50  | 47   | 400 | 35 | ≥63                                       |   |                               |  |                            |   |  |  |   |
| S40U PCLNR/L 19C                                   | ●                      | ● | 40  | 37.5 | 350 | 27 | ≥50                                       | CNM. 1204..                                 | APL-02                        | ALV-03-M8x19                                       | AACN-3-0001                | AAY-02  | ACK-05                                     | 4015-M4x11                                   | AAL-03-3  |
| S50V PCLNR/L 19C                                   | ●                      | ● | 50  | 47   | 400 | 35 | ≥63                                       |   |                               |  |                            |   |  |  |   |
| A20P PCLNR/L 09                                    | ●                      | ● | 20  | 18.3 | 170 | 13 | ≥25                                       | CNM. 1606..                                 | APL-04                        | ALV-04-M8x22                                       | AACN-3-0002                | AAY-03  | ACK-09                                     | AAV-05-M6x15                                 | AAL-05-4  |
| A25R PCLNR/L 12C                                   | ●                      | ● | 25  | 23   | 200 | 17 | ≥32                                       |   |                               |  |                            |   |  |  |   |
| new A25S PCLNR/L 12C                               | ●                      | ○ | 25  | 23   | 250 | 17 | ≥32                                       | CNM. 1906..                                 | APL-05                        | ALV-05-M10x27                                      | AACN-3-0003                | AAY-04  | ACK-09                                     | AAV-05-M6x15                                 | AAL-05-4  |
| A32S PCLNR/L 12C                                   | ●                      | ● | 32  | 30   | 250 | 22 | ≥40                                       |   |                               |  |                            |   |  |  |   |
| new A32T PCLNR/L 12C                               | ○                      | ● | 32  | 30   | 300 | 22 | ≥40                                       | CNM. 1606..                                 | APL-04                        | ALV-04-M8x22                                       | AACN-3-0002                | AAY-03  | ACK-09                                     | AAV-05-M6x15                                 | AAL-05-4  |
| A40T PCLNR/L 12C                                   | ●                      | ● | 40  | 37.5 | 300 | 27 | ≥50                                       |   |                               |  |                            |   |  |  |   |
| A50U PCLNR/L 12C                                   | ●                      | ● | 50  | 47   | 350 | 35 | ≥63                                       | CNM. 1204..                                 | APL-02                        | ALV-03-M8x19                                       | AACN-3-0001                | AAY-02  | ACK-05                                     | 4015-M4x11                                   | AAL-03-3  |
| A32S PCLNR/L 16C                                   | ●                      | ● | 32  | 30   | 250 | 22 | ≥40                                       |   |                               |  |                            |   |  |  |   |
| A40T PCLNR/L 16C                                   | ●                      | ● | 40  | 37.5 | 300 | 27 | ≥50                                       | CNM. 0903..                                 | APL-01                        | ALV-01-M6x17                                       | AACN-2-0002                | AAY-01  | -  | -  | AAL-02-2.5                                      |
| A50U PCLNR/L 16C                                   | ●                      | ● | 50  | 47   | 350 | 35 | ≥63                                       |   |                               |  |                            |   |  |  |   |
| A40T PCLNR/L 19C                                   | ●                      | ● | 40  | 37.5 | 300 | 27 | ≥50                                       | CNM. 1606..                                 | APL-04                        | ALV-04-M8x22                                       | AACN-3-0002                | AAY-03  | ACK-09                                     | AAV-05-M6x15                                 | AAL-05-4  |
| A50U PCLNR/L 19C                                   | ●                      | ● | 50  | 47   | 350 | 35 | ≥63                                       |   |                               |  |                            |   |  |  |   |

R: Sağ / Right / Rechts L: Sol / Left / Links

● Stokta / In Stock / Auf Lager ○ Stokta Yok / Non Stock Item / Kein Lagerartikel, Lieferzeit auf Anfrage

Sipariş Örneği/Ordering Example/Bestellbeispiel

1 ad./pcs./stück S16P PCLNR 09

KAPR=107.5°

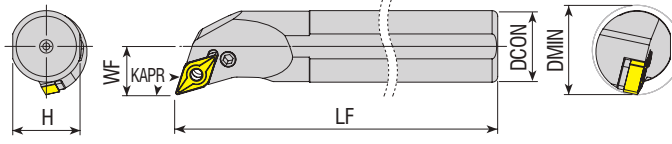

PDQNR

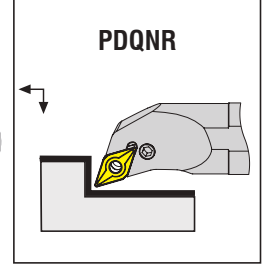

**Takım Kodu**  
**Ordering Code**  
**Bestell-Bezeichnung**

| Stok<br>Stock<br>Lager | Takım Ölçüleri (mm)<br>Dimension (mm)<br>Abmessung (mm) |    |      |     |    |     |             | Kesici Uç<br>Insert<br>Wendeschneidplatte | Levye<br>Lever<br>Kniehebel | Levye Vidası<br>Lever Screw<br>Kniehebelschraube | Yedek Parçaları / Spare Parts / Ersatzteile |   |  |  |            | Anahtar<br>Allen Key<br>Innensechskantschlüssel |
|------------------------|---|----|------|-----|----|-----|-------------|---|-----------------------------|--|---|---|--|--|------------|---|
|                        | R   | L  | DCON | H   | LF | WF  | DMIN        |   |                             |  | Altık<br>Shim<br>Unterlage                  | Altık Yay<br>Shim Spring<br>Feder für Unterlage | Baskı Pabucu<br>Wedge Clamp<br>Spannpratze | Pabuç Vidası<br>Clamp Screw<br>Klemmschraube |            |   |
| ● ○                    |   | 20 | 18.3 | 200 | 13 | ≥25 | DNM. 1104.. |   | APL-01                      | ALV-01-M6x14<br>ALV-02-M6x17                     | AADN-SD317                                  | AAY-01  |  |  | AAL-02-2.5 |   |
| ● ●                    |   | 25 | 23   | 250 | 17 | ≥32 |             |   |                             |  |   |   |  |  |            |   |
| ● ●                    |   | 32 | 30   | 300 | 22 | ≥40 | DNM. 1506.. |   | APL-03                      | ALV-03-M8x19                                     | AADN-3-0001                                 | AAY-02  | -  | -  | AAL-03-3   |   |
| ● ●                    |   | 40 | 37.5 | 350 | 27 | ≥50 |             |   |                             |  |   |   |  |  |            |   |
| ● ●                    |   | 50 | 47   | 400 | 35 | ≥63 | DNM. 1504.. |   | APL-03                      | ALV-03-M8x19                                     | AADN-2-0003                                 | AAY-02  | -  | -  | AAL-03-3   |   |
| ● ●                    |   | 32 | 30   | 300 | 22 | ≥40 |             |   |                             |  |   |   |  |  |            |   |
| ● ●                    |   | 40 | 37.5 | 350 | 27 | ≥50 | DNM. 1504.. |   | APL-03                      | ALV-03-M8x19                                     | AADN-2-0003                                 | AAY-02  | -  | -  | AAL-03-3   |   |
| ● ●                    |   | 50 | 47   | 400 | 35 | ≥63 |             |   |                             |  |   |   |  |  |            |   |
| ● ●                    |   | 20 | 18.3 | 170 | 13 | ≥25 | DNM. 1104.. |   | APL-01                      | ALV-01-M6x14<br>ALV-02-M6x17                     | AADN-SD317                                  | AAY-01  | -  | -  | AAL-02-2.5 |   |
| ● ●                    |   | 25 | 23   | 200 | 17 | ≥32 |             |   |                             |  |   |   |  |  |            |   |
| ● ●                    |   | 32 | 30   | 250 | 22 | ≥40 | DNM. 1506.. |   | APL-03                      | ALV-03-M8x19                                     | AADN-3-0001                                 | AAY-02  | -  | -  | AAL-03-3   |   |
| ● ●                    |   | 40 | 37.5 | 300 | 27 | ≥50 |             |   |                             |  |   |   |  |  |            |   |
| ● ●                    |   | 50 | 47   | 350 | 35 | ≥63 | DNM. 1504.. |   | APL-03                      | ALV-03-M8x19                                     | AADN-2-0003                                 | AAY-02  | -  | -  | AAL-03-3   |   |
| ● ●                    |   | 32 | 30   | 250 | 22 | ≥40 |             |   |                             |  |   |   |  |  |            |   |
| ● ●                    |   | 40 | 37.5 | 300 | 27 | ≥50 |             |   |                             |  |   |   |  |  |            |   |

KAPR=93°

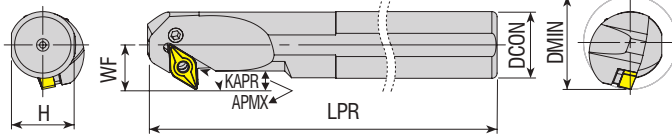

PDXNR

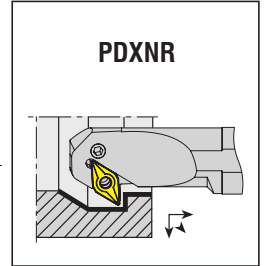

**Takım Kodu**  
**Ordering Code**  
**Bestell-Bezeichnung**

| Stok<br>Stock<br>Lager | Takım Ölçüleri (mm)<br>Dimension (mm)<br>Abmessung (mm) |    |      |     |     |    |      | Kesici Uç<br>Insert<br>Wendeschneidplatte | Levye<br>Lever<br>Kniehebel | Levye Vidası<br>Lever Screw<br>Kniehebelschraube             | Yedek Parçaları / Spare Parts / Ersatzteile |                            |   |  |  | Anahtar<br>Allen Key<br>Innensechskantschlüssel |
|------------------------|---|----|------|-----|-----|----|------|---|-----------------------------|--|---|----------------------------|---|--|--|---|
|                        | R   | L  | DCON | H   | LPR | WF | APMX |   |                             |  | DMIN  | Altık<br>Shim<br>Unterlage | Altık Yay<br>Shim Spring<br>Feder für Unterlage | Baskı Pabucu<br>Wedge Clamp<br>Spannpratze | Pabuç Vidası<br>Clamp Screw<br>Klemmschraube |   |
| ● ●                    |   | 32 | 30   | 300 | 22  | 12 | ≥45  | DNM. 1506..                               | APL-03                      | ALV-08-M8x16<br>ALV-03-M8x19<br>ALV-08-M8x16<br>ALV-03-M8x19 | AADN-3-0001                                 | AAY-02                     | -   | -  | AAL-03-3                                     |   |
| ● ●                    |   | 40 | 37.5 | 350 | 27  | 14 | ≥50  |   |                             |  |   |                            |   |  |  |   |
| ● ●                    |   | 50 | 47   | 400 | 35  | 19 | ≥63  |   |                             |  |   |                            |   |  |  |   |
| ● ●                    |   | 32 | 30   | 250 | 22  | 12 | ≥40  |   |                             |  |   |                            |   |  |  |   |
| ● ●                    |   | 40 | 37.5 | 300 | 27  | 14 | ≥50  |   |                             |  |   |                            |   |  |  |   |
| ● ●                    |   | 50 | 47   | 350 | 35  | 19 | ≥63  |   |                             |  |   |                            |   |  |  |   |

R: Sağ / Right / Rechts L: Sol / Left / Links

● Stokta / In Stock / Auf Lager ○ Stokta Yok / Non Stock Item / Kein Lagerartikel, Lieferzeit auf Anfrage

Not: "APMX" ölçüleri R0.8'e göre verilmiştir. Note: Dimensions of "AMPX" are given according to R.08. Hinweis: Maß "APMX" gilt für Eckenradius 0,8 mm

Sipariş Örneği/Ordering Example/Bestellbeispiel

1 ad./pcs./stück S20R PDQNR 11

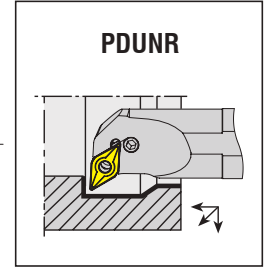
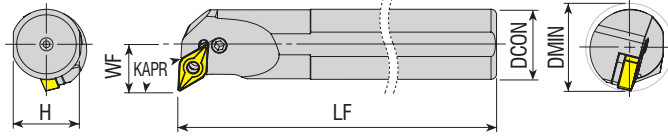

| Takım Kodu<br>Ordering Code<br>Bestell-Bezeichnung | Stok<br>Stock<br>Lager |   | Takım Ölçüleri (mm)<br>Dimension (mm)<br>Abmessung (mm) |      |     |    | Kesici Uç<br>Insert<br>Wendeschneidplatte | Yedek Parçaları / Spare Parts / Ersatzteile |                             |  |                              |  |  |  |   |
|--|------------------------|---|---|------|-----|----|---|---|-----------------------------|--|------------------------------|--|--|--|---|
|  | R                      | L | DCON  | H    | LF  | WF |   | DMIN  | Levyé<br>Lever<br>Kniehebel | Levyé Vidası<br>Lever Screw<br>Kniehebelschraube | Altılık<br>Shim<br>Unterlage | Altılık Yayı<br>Shim Spring<br>Feder für Unterlage | Baskı Pabucu<br>Wedge Clamp<br>Spannpratze | Pabuç Vidası<br>Clamp Screw<br>Klemmschraube | Anahtar<br>Allen Key<br>Innensechskantschlüssel |
| S20R PDUNR/L 11                                    | ●                      | ● | 20  | 18.3 | 200 | 13 | ≥25                                       | DNM. 1104..                                 | APL-01                      | ALV-01-M6x14<br>ALV-02-M6x17<br>ALV-08-M8x16     | AADN-SD317                   | AAY-01   | -  | -  | AAL-02-2.5                                      |
| S25S PDUNR/L 11                                    | ●                      | ● | 25  | 23   | 250 | 17 | ≥32                                       |   |                             |  |                              |  |  |  |   |
| S25S PDUNR/L 15                                    | ●                      | ● | 25  | 23   | 250 | 19 | ≥32                                       |   |                             |  |                              |  |  |  |   |
| S32T PDUNR/L 15                                    | ●                      | ● | 32  | 30   | 300 | 22 | ≥40                                       | DNM. 1506..                                 | APL-03                      | ALV-03-M8x19                                     | AADN-3-0001                  | AAY-02   | -  | -  | AAL-03-3  |
| S40U PDUNR/L 15                                    | ●                      | ● | 40  | 37.5 | 350 | 27 | ≥50                                       |   |                             |  |                              |  |  |  |   |
| S50V PDUNR/L 15                                    | ●                      | ● | 50  | 47   | 400 | 35 | ≥63                                       | DNM. 1104..                                 | APL-01                      | ALV-01-M6x14<br>ALV-02-M6x17                     | AADN-SD317                   | AAY-01   | -  | -  | AAL-02-2.5                                      |
| A20P PDUNR/L 11                                    | ●                      | ● | 20  | 18.3 | 170 | 13 | ≥25                                       |   |                             |  |                              |  |  |  |   |
| A25R PDUNR/L 11                                    | ●                      | ● | 25  | 23   | 200 | 17 | ≥32                                       |   |                             |  |                              |  |  |  |   |
| new A25S PDUNR/L 11                                | ●                      | ○ | 25  | 23   | 250 | 17 | ≥32                                       | DNM. 1506..                                 | APL-03                      | ALV-03-M8x19                                     | AADN-3-0001                  | AAY-02   | -  | -  | AAL-03-3  |
| A32S PDUNR/L 11                                    | ●                      | ● | 32  | 30   | 250 | 22 | ≥40                                       |   |                             |  |                              |  |  |  |   |
| A32S PDUNR/L 15                                    | ●                      | ● | 32  | 30   | 250 | 22 | ≥40                                       | DNM. 1506..                                 | APL-03                      | ALV-03-M8x19                                     | AADN-3-0001                  | AAY-02   | -  | -  | AAL-03-3  |
| A40T PDUNR/L 15                                    | ●                      | ● | 40  | 37.5 | 300 | 27 | ≥50                                       |   |                             |  |                              |  |  |  |   |
| A50U PDUNR/L 15                                    | ●                      | ● | 50  | 47   | 350 | 35 | ≥63                                       |   |                             |  |                              |  |  |  |   |

R: Sağ / Right / Rechts L: Sol / Left / Links

● Stokta / In Stock / Auf Lager ○ Stokta Yok / Non Stock Item / Kein Lagerartikel, Lieferzeit auf Anfrage

Sipariş Örneği/Ordering Example/Bestellbeispiel

1 ad./pcs./stück S20R PDUNR 11



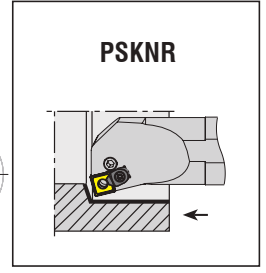
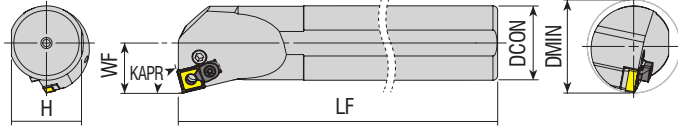

| Takım Kodu<br>Ordering Code<br>Bestell-Bezeichnung | Stok<br>Stock<br>Lager |   | Takım Ölçüleri (mm)<br>Dimension (mm)<br>Abmessung (mm) |      |     |    | Kesici Uç<br>Insert<br>Wendeschneidplatte | Levyeye<br>Lever<br>Kniehebel | Levyeye Vidası<br>Lever Screw<br>Kniehebelschraube | Altılık<br>Shim<br>Unterlage | Altılık Yayını<br>Shim Spring<br>Feder für Unterlage | Baskı Pabuçunu<br>Wedge Clamp<br>Spannpratze | Pabuç Vidasını<br>Clamp Screw<br>Klemmschraube | Anahtar<br>Allen Key<br>Innensechskantschlüssel |          |
|--|------------------------|---|---|------|-----|----|---|-------------------------------|--|------------------------------|--|--|--|---|----------|
|  | R                      | L | DCON  | H    | LF  | WF |   |                               |  |                              |  |  |  |   | DMIN     |
| S25S PSKNR/L 12C                                   | ●                      | ● | 25  | 23   | 250 | 17 | ≥32                                       | SNM. 1204..                   | APL-02   | ALV-08-M8x16                 | AASN-3-0004  | AAY-02                                       | ACK-05   | 4015-M4x11                                      | AAL-03-3 |
| S32T PSKNR/L 12C                                   | ●                      | ● | 32  | 30   | 300 | 22 | ≥40                                       |                               |  |                              |  |  |  |   |          |
| S40U PSKNR/L 12C                                   | ●                      | ● | 40  | 37.5 | 350 | 27 | ≥50                                       |                               |  |                              |  |  |  |   |          |
| S50V PSKNR/L 12C                                   | ●                      | ● | 50  | 47   | 400 | 35 | ≥63                                       |                               |  |                              |  |  |  |   |          |
| S32T PSKNR/L 15C                                   | ○                      | ○ | 32  | 30   | 300 | 22 | ≥40                                       | SNM. 1506..                   | APL-04   | ALV-04-M8x22                 | AASN-3-0023  | AAY-03                                       | ACK-09   | AAV-05-M6x15                                    |          |
| S40U PSKNR/L 15C                                   | ○                      | ○ | 40  | 37.5 | 350 | 27 | ≥50                                       |                               |  |                              |  |  |  |   |          |
| S50V PSKNR/L 15C                                   | ○                      | ○ | 50  | 47   | 400 | 35 | ≥63                                       |                               |  |                              |  |  |  |   |          |
| A25R PSKNR/L 12C                                   | ●                      | ● | 25  | 23   | 200 | 17 | ≥32                                       | SNM. 1204..                   | APL-02   | ALV-08-M8x16                 | AASN-3-0004  | AAY-02                                       | ACK-05   | 4015-M4x11                                      |          |
| A32S PSKNR/L 12C                                   | ●                      | ● | 32  | 30   | 250 | 22 | ≥40                                       |                               |  |                              |  |  |  |   |          |
| A40T PSKNR/L 12C                                   | ●                      | ● | 40  | 37.5 | 300 | 27 | ≥50                                       |                               |  |                              |  |  |  |   |          |
| A50U PSKNR/L 12C                                   | ○                      | ○ | 50  | 47   | 350 | 35 | ≥63                                       |                               |  |                              |  |  |  |   |          |
| A32S PSKNR/L 15C                                   | ●                      | ● | 32  | 30   | 250 | 22 | ≥40                                       | SNM. 1506..                   | APL-04   | ALV-04-M8x22                 | AASN-3-0023  | AAY-03                                       | ACK-09   | AAV-05-M6x15                                    |          |
| A40T PSKNR/L 15C                                   | ●                      | ● | 40  | 37.5 | 300 | 27 | ≥50                                       |                               |  |                              |  |  |  |   |          |
| A50U PSKNR/L 15C                                   | ●                      | ● | 50  | 47   | 350 | 35 | ≥63                                       |                               |  |                              |  |  |  |   |          |

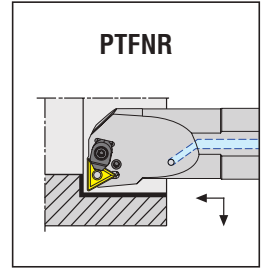
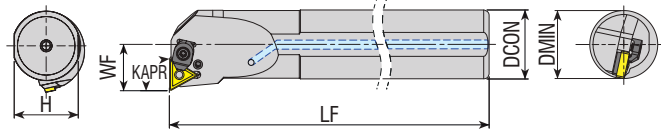

| Takım Kodu<br>Ordering Code<br>Bestell-Bezeichnung | Stok<br>Stock<br>Lager |   | Takım Ölçüleri (mm)<br>Dimension (mm)<br>Abmessung (mm) |    |     |    | Kesici Uç<br>Insert<br>Wendeschneidplatte | Levyeye<br>Lever<br>Kniehebel | Levyeye Vidası<br>Lever Screw<br>Kniehebelschraube | Altılık<br>Shim<br>Unterlage | Altılık Yayını<br>Shim Spring<br>Feder für Unterlage | Baskı Pabuçunu<br>Wedge Clamp<br>Spannpratze | Pabuç Vidasını<br>Clamp Screw<br>Klemmschraube | Anahtar<br>Allen Key<br>Innensechskantschlüssel |          |
|--|------------------------|---|---|----|-----|----|---|-------------------------------|--|------------------------------|--|--|--|---|----------|
|  | R                      | L | DCON  | H  | LF  | WF |   |                               |  |                              |  |  |  |   | DMIN     |
| A25R PTFNR/L 16C                                   | ●                      | ● | 25  | 23 | 200 | 17 | ≥32                                       | TNM. 1604..                   | APL-01   | ALV-02-M6x17                 | AATN-3-0025  | AAY-01                                       | ACK-05   | 4015-M4x11                                      | AAL-03-3 |
| A32S PTFNR/L 16C                                   | ●                      | ● | 32  | 30 | 250 | 22 | ≥40                                       |                               |  |                              |  |  |  |   |          |

R: Sağ / Right / Rechts L: Sol / Left / Links

● Stokta / In Stock / Auf Lager ○ Stokta Yok / Non Stock Item / Kein Lagerartikel, Lieferzeit auf Anfrage

Sipariş Örneği/Ordering Example/Bestellbeispiel

1 ad./pcs./stück S25S PSKNR 12C

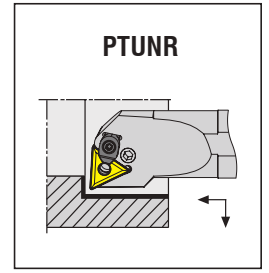
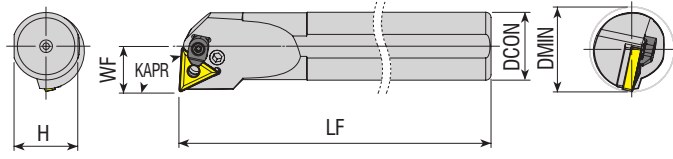

| Takım Kodu<br>Ordering Code<br>Bestell-Bezeichnung | Stok<br>Stock<br>Lager |   | Takım Ölçüleri (mm)<br>Dimension (mm)<br>Abmessung (mm) |      |     |    | Kesici Uç<br>Insert<br>Wendeschneidplatte | Yedek Parçaları / Spare Parts / Ersatzteile |                             |  |                            |  |  |  |   |
|--|------------------------|---|---|------|-----|----|---|---|-----------------------------|--|----------------------------|--|--|--|---|
|  | R                      | L | DCON  | H    | LF  | WF |   | DMIN  | Levyé<br>Lever<br>Kniehebel | Levyé Vidası<br>Lever Screw<br>Kniehebelschraube | Altık<br>Shim<br>Unterlage | Altık Yayı<br>Shim Spring<br>Feder für Unterlage | Baskı Pabucu<br>Wedge Clamp<br>Spannpratze | Pabuç Vidası<br>Clamp Screw<br>Klemmschraube | Anahtar<br>Allen Key<br>Innereckschlüssel |
| <b>S16P PTUNR/L 16</b>                             | ●                      | ● | 16  | 14.8 | 170 | 11 | ≥20                                       | <b>TNM. 1604..</b>                          | APL-08                      | ALV-07-M6x13                                     | -                          | AAY-07   | -  | -  | AAL-02-2.5                                |
| <b>S20R PTUNR/L 16</b>                             | ●                      | ● | 20  | 18.3 | 200 | 13 | ≥25                                       |   | APL-01                      | ALV-01-M6x14                                     | AATN-3-0025                | AAY-01   | ACK-05                                     | 4015-M4x11                                   |   |
| <b>S25S PTUNR/L 16C</b>                            | ●                      | ● | 25  | 23   | 250 | 17 | ≥32                                       |   |                             | ALV-02-M6x17                                     |                            |  |  |  |   |
| <b>S32T PTUNR/L 16C</b>                            | ●                      | ● | 32  | 30   | 300 | 22 | ≥40                                       |   |                             |  |                            |  |  |  |   |
| <b>S40U PTUNR/L 16C</b>                            | ●                      | ● | 40  | 37.5 | 350 | 27 | ≥50                                       |   |                             |  |                            |  |  |  |   |
| <b>S32T PTUNR/L 22C</b>                            | ●                      | ● | 32  | 30   | 300 | 22 | ≥40                                       | <b>TNM. 2204..</b>                          | APL-02                      | ALV-03-M8x19                                     | AATN-3-0015                | AAY-02   | ACK-05                                     | 4015-M4x11                                   | AAL-03-3                                  |
| <b>S40U PTUNR/L 22C</b>                            | ●                      | ● | 40  | 37.5 | 350 | 27 | ≥50                                       |   |                             |  |                            |  |  |  |   |
| <b>S50V PTUNR/L 22C</b>                            | ●                      | ● | 50  | 47   | 400 | 35 | ≥63                                       |   |                             |  |                            |  |  |  |   |
| <b>A16M PTUNR/L 16</b>                             | ●                      | ● | 16  | 14.8 | 150 | 11 | ≥20                                       | <b>TNM. 1604..</b>                          | APL-08                      | ALV-07-M6x13                                     | -                          | AAY-07   | -  | -  | AAL-02-2.5                                |
| <b>A20P PTUNR/L 16</b>                             | ●                      | ● | 20  | 18.3 | 170 | 13 | ≥25                                       |   | APL-01                      | ALV-01-M6x14                                     | AATN-3-0025                | AAY-01   | ACK-05                                     | 4015-M4x11                                   |   |
| <b>A25R PTUNR/L 16C</b>                            | ●                      | ● | 25  | 23   | 200 | 17 | ≥32                                       |   |                             | ALV-02-M6x17                                     |                            |  |  |  |   |
| <b>A32S PTUNR/L 16C</b>                            | ●                      | ● | 32  | 30   | 250 | 22 | ≥40                                       |   |                             |  |                            |  |  |  |   |
| <b>A40T PTUNR/L 16C</b>                            | ●                      | ● | 40  | 37.5 | 300 | 27 | ≥50                                       |   |                             |  |                            |  |  |  |   |
| <b>A32S PTUNR/L 22C</b>                            | ●                      | ● | 32  | 30   | 250 | 22 | ≥40                                       | <b>TNM. 2204..</b>                          | APL-02                      | ALV-03-M8x19                                     | AATN-3-0015                | AAY-02   | ACK-05                                     | 4015-M4x11                                   | AAL-03-3                                  |
| <b>A40T PTUNR/L 22C</b>                            | ●                      | ● | 40  | 37.5 | 300 | 27 | ≥50                                       |   |                             |  |                            |  |  |  |   |

R: Sağ / Right / Rechts L: Sol / Left / Links

● Stokta / In Stock / Auf Lager ○ Stokta Yok / Non Stock Item / Kein Lagerartikel, Lieferzeit auf Anfrage

Sipariş Örneği/Ordering Example/Bestellbeispiel

1 ad./pcs./stück S16P PTUNR 16



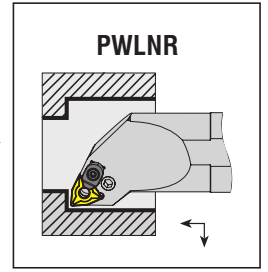
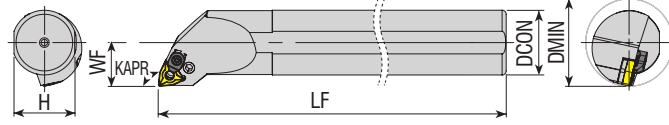

Yedek Parçaları / Spare Parts / Ersatzteile

| Takım Kodu<br>Ordering Code<br>Bestell-Bezeichnung | Stok<br>Stock<br>Lager |   | Takım Ölçüleri (mm)<br>Dimension (mm)<br>Abmessung (mm) |      |     |    | Kesici Uç<br>Insert<br>Wendeschneidplatte | Levye<br>Lever<br>Kniehebel | Levye Vidası<br>Lever Screw<br>Kniehebelschraube | Altık<br>Shim<br>Unterlage | Altık Yay<br>Shim Spring<br>Feder für Unterlage | Baskı Pabucu<br>Wedge Clamp<br>Spannpratze | Pabuç Vidası<br>Clamp Screw<br>Klemmschraube | Anahtar<br>Allen Key<br>Innerschraubschlüssel |            |
|--|------------------------|---|---|------|-----|----|---|-----------------------------|--|----------------------------|---|--|--|---|------------|
|  | R                      | L | DCON  | H    | LF  | WF | DMIN                                      |                             |  |                            |   |  |  |   |            |
| S20R PWLNR/L 06                                    | ●                      | ● | 20  | 18.3 | 200 | 13 | ≥25                                       | WNM. 0604..                 | APL-01   | ALV-01-M6x14               | AAWN-SW317                                      | AAY-01                                     | -  | -   | AAL-02-2.5 |
| S25S PWLNR/L 06                                    | ●                      | ● | 25  | 23   | 250 | 17 | ≥32                                       |                             |  |                            |   |  |  |   |            |
| S32T PWLNR/L 06                                    | ●                      | ● | 32  | 30   | 300 | 22 | ≥40                                       |                             |  |                            |   |  |  |   |            |
| S25S PWLNR/L 08C                                   | ●                      | ● | 25  | 23   | 250 | 17 | ≥32                                       | WNM. 0804..                 | APL-02   | ALV-03-M8x19               | AAWN-3-0001                                     | AAY-02                                     | ACK-05                                       | 4015-M4x11                                    | AAL-03-3   |
| S32T PWLNR/L 08C                                   | ●                      | ● | 32  | 30   | 300 | 22 | ≥40                                       |                             |  |                            |   |  |  |   |            |
| S40U PWLNR/L 08C                                   | ●                      | ● | 40  | 37.5 | 350 | 27 | ≥50                                       |                             |  |                            |   |  |  |   |            |
| S50V PWLNR/L 08C                                   | ●                      | ● | 50  | 47   | 400 | 35 | ≥63                                       | WNM. 0604..                 | APL-08   | ALV-07-M6x13               | -   | AAY-07                                     | -  | -   | AAL-02-2.5 |
| A16M PWLNR/L 06                                    | ●                      | ● | 16  | 14.8 | 150 | 11 | ≥20                                       |                             |  |                            |   |  |  |   |            |
| A20P PWLNR/L 06                                    | ●                      | ● | 20  | 18.3 | 170 | 13 | ≥25                                       |                             |  |                            |   |  |  |   |            |
| A25R PWLNR/L 06                                    | ●                      | ● | 25  | 23   | 200 | 17 | ≥32                                       | WNM. 0604..                 | APL-01   | ALV-02-M6x17               | AAWN-SW317                                      | AAY-01                                     | -  | -   | AAL-02-2.5 |
| A32S PWLNR/L 06                                    | ●                      | ● | 32  | 30   | 250 | 22 | ≥40                                       |                             |  |                            |   |  |  |   |            |
| A40T PWLNR/L 06C                                   | ●                      | ○ | 40  | 37.5 | 300 | 27 | ≥50                                       |                             |  |                            |   |  |  |   |            |
| A25R PWLNR/L 08C                                   | ●                      | ● | 25  | 23   | 200 | 17 | ≥32                                       | WNM. 0804..                 | APL-02   | ALV-03-M8x19               | AAWN-3-0001                                     | AAY-02                                     | ACK-05                                       | 4015-M4x11                                    | AAL-03-3   |
| A32S PWLNR/L 08C                                   | ●                      | ● | 32  | 30   | 250 | 22 | ≥40                                       |                             |  |                            |   |  |  |   |            |
| A40T PWLNR/L 08C                                   | ●                      | ● | 40  | 37.5 | 300 | 27 | ≥50                                       |                             |  |                            |   |  |  |   |            |
| A50U PWLNR/L 08C                                   | ●                      | ● | 50  | 47   | 350 | 35 | ≥63                                       |                             |  |                            |   |  |  |   |            |

R: Sağ / Right / Rechts L: Sol / Left / Links

● Stokta / In Stock / Auf Lager ○ Stokta Yok / Non Stock Item / Kein Lagerartikel, Lieferzeit auf Anfrage

Sipariş Örneği/Ordering Example/Bestellbeispiel

1 ad./pcs./stück S20R PWLNR 06





*konusulan  
the spoken kalite...  
quality...*

# S-SİSTEM

**S-SİSTEM DELİK TORNA KATERLERİ**  
*S-SYSTEM BORING BARS*  
*S-SYSTEM BOHRSTANGE*



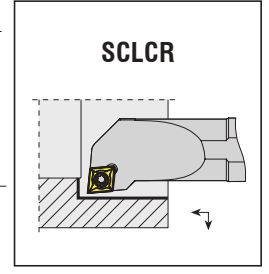
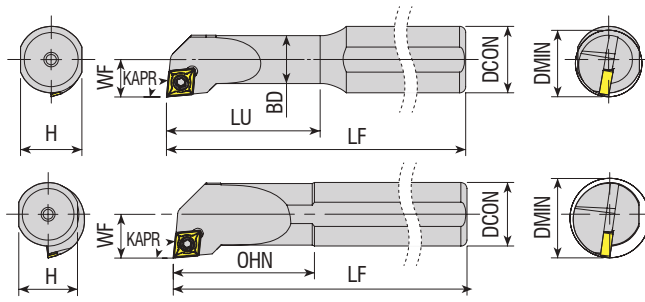

**Takım Kodu**  
**Ordering Code**  
*Bestell-Bezeichnung*

| Stok<br>Stock<br>Lager | Takım Ölçüleri (mm)<br>Dimension (mm)<br>Abmessung (mm) |   |      |      |      |        |     |     | Kesici Uç<br>Insert<br>Wendeschneidplatte | Yedek Parçaları / Spare Parts / Ersatzteile |  |                             |   |   |
|------------------------|---|---|------|------|------|--------|-----|-----|---|---|--|-----------------------------|---|---|
|                        | R   | L | DCON | BD   | H    | LU=OHN | LF  | WF  |   | DMIN  | Sıkma Vidası<br>Screw<br>Klemmschraube | Altlık<br>Shim<br>Unterlage | Altlık Vidası<br>Shim Screw<br>Schraube für Unterlage | Tork Anahtar<br>Torx Key<br>Torx Imensechskantschlüssel |
|                        | ●   | ○ | 08   | 5    | 7.3  | 18     | 100 | 3   | ≥6  | CC.T 030102                                 | 4006-M1.6x3.2                          |                             |   | 82-T06  |
| S0508H SCLCR/L 03      |   |   |      |      |      |        |     |     |   |   | 4008-M2.5x4.5                          |                             |   |   |
| S0608H SCLCR/L 06      | ●   | ● | 08   | 6    | 7.3  | 25     | 100 | 4.5 | ≥8  |   |  |                             |   |   |
| S08H SCLCR/L 06        | ●   | ● | 08   | 8    | 7.3  | 20     | 100 | 06  | ≥11                                       | CC.T 0602..                                 | 4008-M2.5x6                            | -                           | -   | 82-T08  |
| S10K SCLCR/L 06        | ●   | ● | 10   | 10   | 09   | 25     | 125 | 07  | ≥13                                       |   |  |                             |   |   |
| S12K SCLCR/L 06        | ●   | ● | 12   | 12   | 11   | 25     | 125 | 09  | ≥16                                       |   |  |                             |   |   |
| S1216P SCLCR/L 06      | ●   | ● | 16   | 11.5 | 14.8 | 37     | 170 | 09  | ≥16                                       | CC.T 09T3..                                 | 4015-M3.5x8                            |                             |   | 80-T15  |
| S16P SCLCR/L 06        | ●   | ● | 16   | 16   | 14.8 | 35     | 170 | 11  | ≥20                                       |   | 4015-M3.5x9                            | -                           | -   |   |
| S12K SCLCR/L 09        | ●   | ● | 12   | 12   | 11   | 30     | 125 | 09  | ≥16                                       |   |  |                             |   |   |
| S1416P SCLCR/L 09      | ●   | ● | 16   | 14   | 14.8 | 45     | 170 | 9.5 | ≥17                                       | CC.T 1204..                                 | 4015-M3.5x12                           | AACN-2-0001                 | AAV-08-M3.5x8   | 80-T20  |
| S16P SCLCR/L 09        | ●   | ● | 16   | 16   | 14.8 | 35     | 170 | 11  | ≥20                                       |   | 4020-M4.5x12                           | AACN-2-0003                 | AAV-10-M4.5x8   |   |
| S1620R SCLCR/L 09      | ●   | ● | 20   | 16   | 18.3 | 50     | 200 | 11  | ≥20                                       |   | 1020-M4.5x16                           |                             |   |   |
| S20R SCLCR/L 09        | ●   | ● | 20   | 20   | 18.3 | 40     | 200 | 13  | ≥25                                       | CC.T 0602..                                 | 4008-M2.5x6                            | -                           | -   | 82-T08  |
| S25S SCLCR/L 09        | ●   | ● | 25   | 25   | 23   | 50     | 250 | 17  | ≥32                                       |   |  |                             |   |   |
| S32T SCLCR/L 09        | ●   | ● | 32   | 32   | 30   | 60     | 300 | 22  | ≥40                                       |   |  |                             |   |   |
| S25S SCLCR/L 12        | ●   | ● | 25   | 25   | 23   | 50     | 250 | 17  | ≥32                                       | CC.T 09T3..                                 | 4015-M3.5x9                            | -                           | -   | 80-T15  |
| S32T SCLCR/L 12        | ●   | ● | 32   | 32   | 30   | 60     | 300 | 22  | ≥40                                       |   | 4015-M3.5x12                           | AACN-2-0001                 | AAV-08-M3.5x8   |   |
| S40U SCLCR/L 12        | ●   | ● | 40   | 40   | 37.5 | 70     | 350 | 27  | ≥50                                       |   | 4015-M3.5x12                           | AACN-2-0001                 | AAV-08-M3.5x8   |   |
| A08H SCLCR/L 06        | ●   | ● | 08   | 8    | 7.3  | 20     | 100 | 06  | ≥11                                       | CC.T 1204..                                 | 4020-M4.5x12                           | AACN-2-0003                 | AAV-10-M4.5x8   | 80-T20  |
| A10H SCLCR/L 06        | ●   | ● | 10   | 10   | 09   | 25     | 100 | 07  | ≥13                                       |   | 4020-M4.5x12                           | AACN-2-0003                 | AAV-10-M4.5x8   |   |
| A12H SCLCR/L 06        | ●   | ● | 12   | 12   | 11   | 25     | 100 | 09  | ≥16                                       |   |  |                             |   |   |
| A16M SCLCR/L 09        | ●   | ● | 16   | 16   | 14.8 | 35     | 150 | 11  | ≥20                                       | CC.T 09T3..                                 | 4015-M3.5x9                            | -                           | -   | 80-T15  |
| A20P SCLCR/L 09        | ●   | ● | 20   | 20   | 18.3 | 40     | 170 | 13  | ≥25                                       |   | 4015-M3.5x12                           | AACN-2-0001                 | AAV-08-M3.5x8   |   |
| A25R SCLCR/L 09        | ●   | ● | 25   | 25   | 23   | 50     | 200 | 17  | ≥32                                       |   | 4015-M3.5x12                           | AACN-2-0001                 | AAV-08-M3.5x8   |   |
| A32S SCLCR/L 09        | ●   | ● | 32   | 32   | 30   | 60     | 250 | 22  | ≥40                                       | CC.T 1204..                                 | 4020-M4.5x12                           | AACN-2-0003                 | AAV-10-M4.5x8   | 80-T20  |
| A25R SCLCR/L 12        | ●   | ● | 25   | 25   | 23   | 50     | 200 | 17  | ≥32                                       |   | 4020-M4.5x12                           | AACN-2-0003                 | AAV-10-M4.5x8   |   |

R: Sağ / Right / Rechts L: Sol / Left / Links

● Stokta / In Stock / Auf Lager ○ Stokta Yok / Non Stock Item / Kein Lagerartikel, Lieferzeit auf Anfrage

Sipariş Örneği/Ordering Example/Bestellbeispiel

1 ad./pcs./stück S0508H SCLCR 03



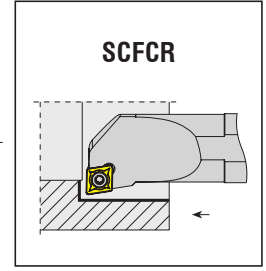
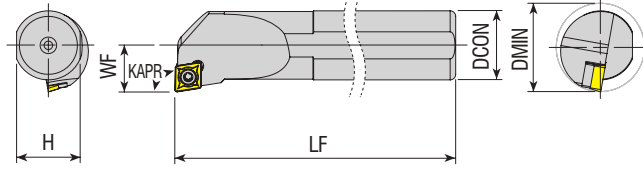

**Takım Kodu**  
**Ordering Code**  
*Bestell-Bezeichnung*

| Stok<br>Stock<br>Lager | Takım Ölçüleri (mm)<br>Dimension (mm)<br>Abmessung (mm) |   |      |      |     |    | Kesici Uç<br>Insert<br>Wendeschneidplatte | Yedek Parçaları / Spare Parts / Ersatzteile |  |                             |   |  |
|------------------------|---|---|------|------|-----|----|---|---|--|-----------------------------|---|--|
|                        | R   | L | DCON | H    | LF  | WF |   | DMIN  | Sıkma Vidası<br>Screw<br>Klemmschraube | Altlık<br>Shim<br>Unterlage | Altlık Vidası<br>Shim Screw<br>Schraube für Unterlage | Tork Anahtar<br>Torx Key<br>Torx Innensechskantschlüssel |
|                        | ●   | ● | 08   | 7.3  | 100 | 06 | ≥11                                       | CC.T 0602..                                 | 4008-M2.5x6                            | -                           | -   | 82-T08   |
| S08H SCFCR/L 06        | ●   | ● | 10   | 09   | 125 | 07 | ≥13                                       |   | 4015-M3.5x8                            |                             |   |  |
| S10K SCFCR/L 06        | ●   | ● | 12   | 11   | 125 | 09 | ≥16                                       |   | 4015-M3.5x9                            | -                           | -   |  |
| S12K SCFCR/L 06        | ●   | ● | 12   | 11   | 125 | 09 | ≥16                                       | CC.T 09T3..                                 | 4015-M3.5x12                           | AACN-2-0001                 | AAV-08-M3.5x8   | 80-T15   |
| S12K SCFCR/L 09        | ●   | ● | 16   | 14.8 | 170 | 11 | ≥20                                       |   | 4015-M3.5x9                            | -                           | -   |  |
| S16P SCFCR/L 09        | ●   | ● | 20   | 18.3 | 200 | 13 | ≥25                                       |   | 4015-M3.5x12                           | AACN-2-0001                 | AAV-08-M3.5x8   |  |
| S20R SCFCR/L 09        | ●   | ● | 25   | 23   | 250 | 17 | ≥32                                       | CC.T 1204..                                 | 4020-M4.5x12                           | AACN-2-0003                 | AAV-10-M4.5x8   | 80-T20   |
| S25S SCFCR/L 09        | ●   | ○ | 25   | 23   | 250 | 17 | ≥32                                       |   | 1020-M4.5x16                           |                             |   |  |
| S25S SCFCR/L 12        | ○   | ○ | 32   | 30   | 300 | 22 | ≥40                                       |   | 4008-M2.5x6                            | -                           | -   |  |
| S32T SCFCR/L 12        | ○   | ○ | 40   | 37.5 | 350 | 27 | ≥50                                       | CC.T 0602..                                 | 4008-M2.5x6                            | -                           | -   | 82-T08   |
| S40U SCFCR/L 12        | ○   | ○ | 08   | 7.3  | 100 | 06 | ≥11                                       |   |  |                             |   |  |
| A08H SCFCR/L 06        | ●   | ○ |      |      |     |    |   |   |  |                             |   |  |

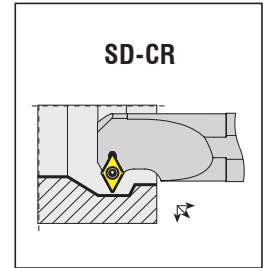
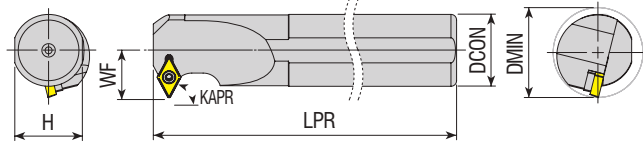

**Takım Kodu**  
**Ordering Code**  
*Bestell-Bezeichnung*

| Stok<br>Stock<br>Lager | Takım Ölçüleri (mm)<br>Dimension (mm)<br>Abmessung (mm) |   |      |      |     |    | Kesici Uç<br>Insert<br>Wendeschneidplatte | Yedek Parçaları / Spare Parts / Ersatzteile |  |                             |   |  |
|------------------------|---|---|------|------|-----|----|---|---|--|-----------------------------|---|--|
|                        | R   | L | DCON | H    | LPR | WF |   | DMIN  | Sıkma Vidası<br>Screw<br>Klemmschraube | Altlık<br>Shim<br>Unterlage | Altlık Vidası<br>Shim Screw<br>Schraube für Unterlage | Tork Anahtar<br>Torx Key<br>Torx Innensechskantschlüssel |
| S10K SD-CR/L 07        | ●   | ● | 10   | 9    | 125 | 07 | ≥14                                       | DC.T 0702..                                 | 4008-M2.5x6                            | -                           | -   | 82-T08   |
| S12K SD-CR/L 07        | ●   | ● | 12   | 11   | 125 | 09 | ≥16                                       |   | 4015-M3.5x11                           | -                           | -   |  |
| S16P SD-CR/L 07        | ●   | ● | 16   | 14.8 | 170 | 11 | ≥20                                       |   | 4015-M3.5x14                           | AADN-2-0001                 | AAV-06-M3.5x11  |  |
| S20R SD-CR/L 07        | ●   | ○ | 20   | 18.3 | 200 | 13 | ≥25                                       | DC.T 11T3..                                 | 4015-M3.5x11                           | -                           | -   | 80-T15   |
| S16P SD-CR/L 11        | ●   | ● | 16   | 14.8 | 170 | 14 | ≥22                                       |   | 4015-M3.5x14                           | AADN-2-0001                 | AAV-06-M3.5x11  |  |
| S20R SD-CR/L 11        | ●   | ● | 20   | 18.3 | 200 | 15 | ≥25                                       |   |  |                             |   |  |
| S25S SD-CR/L 11        | ●   | ● | 25   | 23   | 250 | 18 | ≥32                                       |   |  |                             |   |  |
| S32T SD-CR/L 11        | ●   | ● | 32   | 30   | 300 | 22 | ≥40                                       |   |  |                             |   |  |
| S40U SD-CR/L 11        | ●   | ● | 40   | 37.5 | 350 | 27 | ≥50                                       |   |  |                             |   |  |

R: Sağ / Right / Rechts L: Sol / Left / Links  
● Stokta / In Stock / Auf Lager ○ Stokta Yok / Non Stock Item / Kein Lagerartikel, Lieferzeit auf Anfrage

Sipariş Örneği/Ordering Example/Bestellbeispiel  
1 ad./pcs./stück S08H SCFCR 06

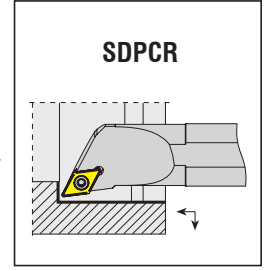
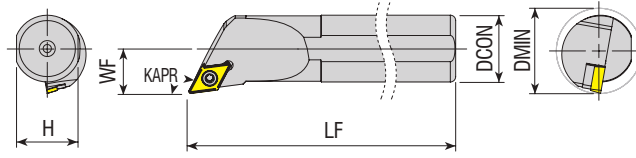

**Takım Kodu**  
**Ordering Code**  
*Bestell-Bezeichnung*

| Stok<br>Stock<br>Lager | Takım Ölçüleri (mm)<br>Dimension (mm)<br>Abmessung (mm) |   |      |      |     |    | Kesici Uç<br>Insert<br>Wendeschneidplatte | Yedek Parçaları / Spare Parts / Ersatzteile |  |                             |   |  |
|------------------------|---|---|------|------|-----|----|---|---|--|-----------------------------|---|--|
|                        | R   | L | DCON | H    | LF  | WF |   | DMIN  | Sıkma Vidası<br>Screw<br>Klemmschraube | Altlık<br>Shim<br>Unterlage | Altlık Vidası<br>Shim Screw<br>Schraube für Unterlage | Tork Anahtar<br>Torx Key<br>Torx Innensechskantschlüssel |
| <b>S10K SDPCR/L 07</b> | ●   | ● | 10   | 09   | 125 | 07 | ≥13                                       | <b>DC.T 0702..</b>                          | 4008-M2.5x6                            | -                           | -   | 82-T08   |
| <b>S12K SDPCR/L 07</b> | ●   | ● | 12   | 11   | 125 | 09 | ≥16                                       |   |  |                             |   |  |
| <b>S16P SDPCR/L 11</b> | ●   | ● | 16   | 14.8 | 170 | 11 | ≥20                                       | <b>DC.T 11T3..</b>                          | 4015-M3.5x9                            | -                           | -   | 80-T15   |
| <b>S20R SDPCR/L 11</b> | ●   | ● | 20   | 18.3 | 200 | 13 | ≥25                                       |   | 4015-M3.5x11                           |                             |   |  |
| <b>S25S SDPCR/L 11</b> | ●   | ● | 25   | 23   | 250 | 17 | ≥32                                       |   | 4015-M3.5x12                           |                             |   |  |

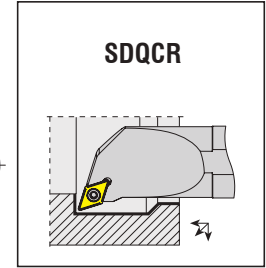
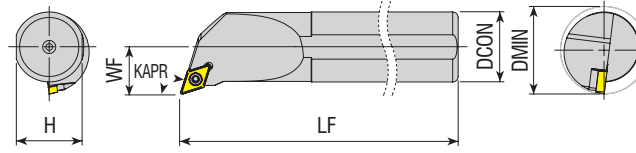

**Takım Kodu**  
**Ordering Code**  
*Bestell-Bezeichnung*

| Stok<br>Stock<br>Lager | Takım Ölçüleri (mm)<br>Dimension (mm)<br>Abmessung (mm) |   |      |      |     |    | Kesici Uç<br>Insert<br>Wendeschneidplatte | Yedek Parçaları / Spare Parts / Ersatzteile |  |                             |   |  |
|------------------------|---|---|------|------|-----|----|---|---|--|-----------------------------|---|--|
|                        | R   | L | DCON | H    | LF  | WF |   | DMIN  | Sıkma Vidası<br>Screw<br>Klemmschraube | Altlık<br>Shim<br>Unterlage | Altlık Vidası<br>Shim Screw<br>Schraube für Unterlage | Tork Anahtar<br>Torx Key<br>Torx Innensechskantschlüssel |
| <b>S10K SDQCR/L 07</b> | ●   | ● | 10   | 09   | 125 | 07 | ≥13                                       | <b>DC.T 0702..</b>                          | 4008-M2.5x6                            | -                           | -   | 82-T08   |
| <b>S12K SDQCR/L 07</b> | ●   | ● | 12   | 11   | 125 | 09 | ≥16                                       |   |  |                             |   |  |
| <b>S16P SDQCR/L 07</b> | ●   | ● | 16   | 14.8 | 170 | 11 | ≥20                                       | <b>DC.T 11T3..</b>                          | 4015-M3.5x9                            | -                           | -   | 80-T15   |
| <b>S20R SDQCR/L 07</b> | ●   | ● | 20   | 18.3 | 200 | 13 | ≥25                                       |   | 4015-M3.5x11                           |                             |   |  |
| <b>S16P SDQCR/L 11</b> | ●   | ● | 16   | 14.8 | 170 | 11 | ≥20                                       |   | 4015-M3.5x12                           |                             |   |  |
| <b>S20R SDQCR/L 11</b> | ●   | ● | 20   | 18.3 | 200 | 13 | ≥25                                       | 4015-M3.5x14                                |  | AAV-06-M3.5x11              |   |  |
| <b>S25S SDQCR/L 11</b> | ●   | ● | 25   | 23   | 250 | 17 | ≥32                                       | <b>DC.T 11T3..</b>                          | 4015-M3.5x9                            | -                           | -   | 80-T15   |
| <b>S32T SDQCR/L 11</b> | ●   | ● | 32   | 30   | 300 | 22 | ≥40                                       |   |  |                             |   |  |
| <b>S40U SDQCR/L 11</b> | ●   | ● | 40   | 37.5 | 350 | 27 | ≥50                                       | <b>DC.T 0702..</b>                          | 4008-M2.5x6                            | -                           | -   | 82-T08   |
| <b>A10H SDQCR/L 07</b> | ●   | ● | 10   | 09   | 100 | 07 | ≥13                                       |   |  |                             |   |  |
| <b>A12H SDQCR/L 07</b> | ●   | ● | 12   | 11   | 100 | 09 | ≥16                                       | <b>DC.T 11T3..</b>                          | 4015-M3.5x9                            | -                           | -   | 80-T15   |
| <b>A16M SDQCR/L 07</b> | ●   | ● | 16   | 14.8 | 150 | 11 | ≥20                                       |   |  |                             |   |  |
| <b>A20P SDQCR/L 07</b> | ●   | ● | 20   | 18.3 | 170 | 13 | ≥25                                       | <b>DC.T 11T3..</b>                          | 4015-M3.5x11                           | -                           | -   | 80-T15   |
| <b>A16M SDQCR/L 11</b> | ●   | ● | 16   | 14.8 | 150 | 11 | ≥20                                       |   |  |                             |   |  |
| <b>A20P SDQCR/L 11</b> | ●   | ● | 20   | 18.3 | 170 | 13 | ≥25                                       | 4015-M3.5x12                                | AADN-2-0001                            | AAV-08-M3.5x8               |   |  |
| <b>A25R SDQCR/L 11</b> | ●   | ● | 25   | 23   | 200 | 17 | ≥32                                       | 4015-M3.5x14                                |  |                             | AAV-06-M3.5x11  |  |
| <b>A32S SDQCR/L 11</b> | ●   | ● | 32   | 30   | 250 | 22 | ≥40                                       |   |  |                             |   |  |

R: Sağ / Right / Rechts L: Sol / Left / Links

● Stokta / In Stock / Auf Lager ○ Stokta Yok / Non Stock Item / Kein Lagerartikel, Lieferzeit auf Anfrage

Sipariş Örneği/Ordering Example/Bestellbeispiel

1 ad./pcs./stück S10K SDPCR 07

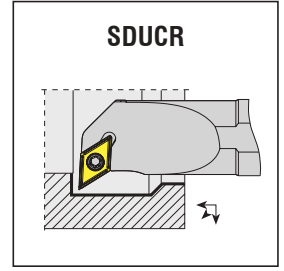
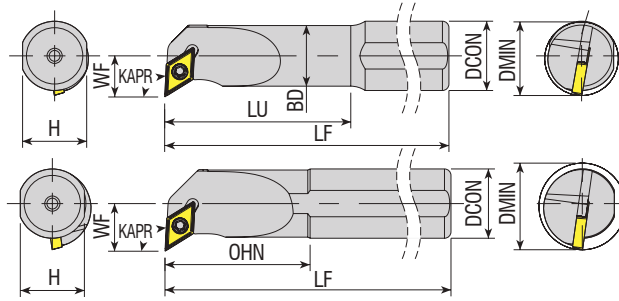

**Takım Kodu**  
**Ordering Code**  
**Bestell-Bezeichnung**

| Takım Kodu<br>Ordering Code<br>Bestell-Bezeichnung | Stok<br>Stock<br>Lager |   | Takım Ölçüleri (mm)<br>Dimension (mm)<br>Abmessung (mm) |      |      |        |     |     |      | Kesici Uç<br>Insert<br>Wendeschneidplatte | Yedek Parçaları / Spare Parts / Ersatzteile |                             |   |  |
|--|------------------------|---|---|------|------|--------|-----|-----|------|---|---|-----------------------------|---|--|
|  | R                      | L | DCON  | BD   | H    | LU=OHN | LF  | WF  | DMIN |   | Sıkma Vidası<br>Screw<br>Klemmschraube      | Altlık<br>Shim<br>Unterlage | Altlık Vidası<br>Shim Screw<br>Schraube für Unterlage | Tork Anahtar<br>Torx Key<br>Torx Innerschraubenschlüssel |
| S0810K SDUCR/L 07                                  | ●                      | ● | 10  | 8    | 09   | 30     | 125 | 08  | ≥13  | DC.T 0702..                               | 4008-M2.5x6                                 | -                           | -   | 82-T08   |
| S10K SDUCR/L 07                                    | ●                      | ● | 10  | 10   | 09   | 25     | 125 | 08  | ≥13  |   |   |                             |   |  |
| S12K SDUCR/L 07                                    | ●                      | ● | 12  | 12   | 11   | 25     | 125 | 09  | ≥16  |   |   |                             |   |  |
| S1216P SDUCR/L 07                                  | ●                      | ● | 16  | 11.5 | 14.8 | 37     | 170 | 09  | ≥16  |   |   |                             |   |  |
| S1416P SDUCR/L 07                                  | ●                      | ● | 16  | 14   | 14.8 | 45     | 170 | 9.5 | ≥17  |   |   |                             |   |  |
| S16P SDUCR/L 07                                    | ●                      | ● | 16  | 16   | 14.8 | 35     | 170 | 11  | ≥20  |   |   |                             |   |  |
| S20R SDUCR/L 07                                    | ●                      | ● | 20  | 20   | 18.3 | 40     | 200 | 13  | ≥25  | DC.T 11T3..                               | 4015-M3.5x9                                 | -                           | -   | 80-T15   |
| S1416P SDUCR/L 11                                  | ●                      | ● | 16  | 14   | 14.8 | 45     | 170 | 11  | ≥18  |   |   |                             |   |  |
| S16P SDUCR/L 11                                    | ●                      | ● | 16  | 16   | 14.8 | 35     | 170 | 11  | ≥20  |   |   |                             |   |  |
| S1620R SDUCR/L 11                                  | ●                      | ● | 20  | 16   | 18.3 | 50     | 200 | 11  | ≥20  |   |   |                             |   |  |
| S20R SDUCR/L 11                                    | ●                      | ● | 20  | 20   | 18.3 | 40     | 200 | 13  | ≥25  |   |   |                             |   |  |
| S25S SDUCR/L 11                                    | ●                      | ● | 25  | 25   | 23   | 50     | 250 | 17  | ≥32  |   |   |                             |   |  |
| <b>new</b> S25T SDUCR/L 11                         | ●                      | ● | 25  | 25   | 23   | 50     | 300 | 17  | ≥32  |   |   |                             |   |  |
| S32T SDUCR/L 11                                    | ●                      | ● | 32  | 32   | 30   | 60     | 300 | 22  | ≥40  |   |   |                             |   |  |
| S40U SDUCR/L 11                                    | ●                      | ● | 40  | 40   | 37.5 | 70     | 350 | 27  | ≥50  |   |   |                             |   |  |
| S50V SDUCR/L 11                                    | ●                      | ● | 50  | 50   | 47   | 80     | 400 | 35  | ≥63  |   |   |                             |   |  |
| A0810H SDUCR/L 07                                  | ●                      | ● | 10  | 8    | 09   | 30     | 100 | 08  | ≥13  | DC.T 0702..                               | 4008-M2.5x6                                 | -                           | -   | 82-T08   |
| A10H SDUCR/L 07                                    | ●                      | ● | 10  | 10   | 09   | 25     | 100 | 08  | ≥13  |   |   |                             |   |  |
| A12H SDUCR/L 07                                    | ●                      | ● | 12  | 12   | 11   | 25     | 100 | 09  | ≥16  |   |   |                             |   |  |
| A16M SDUCR/L 07                                    | ●                      | ● | 16  | 16   | 14.8 | 35     | 150 | 11  | ≥20  |   |   |                             |   |  |
| A20P SDUCR/L 07                                    | ●                      | ● | 20  | 20   | 18.3 | 40     | 170 | 13  | ≥25  |   |   |                             |   |  |
| A16M SDUCR/L 11                                    | ●                      | ● | 16  | 16   | 14.8 | 35     | 150 | 11  | ≥20  |   |   |                             |   |  |
| A20P SDUCR/L 11                                    | ●                      | ● | 20  | 20   | 18.3 | 40     | 170 | 13  | ≥25  | DC.T 11T3..                               | 4015-M3.5x12                                | AADN-2-0001                 | AAV-08-M3.5x8   | 80-T15   |
| A25R SDUCR/L 11                                    | ●                      | ● | 25  | 25   | 23   | 50     | 200 | 17  | ≥32  |   |   |                             |   |  |
| <b>new</b> A25T SDUCR/L 11                         | ●                      | ○ | 25  | 25   | 23   | 50     | 300 | 17  | ≥32  |   |   |                             |   |  |
| A32S SDUCR/L 11                                    | ●                      | ● | 32  | 32   | 30   | 60     | 250 | 22  | ≥40  |   |   |                             |   |  |
| <b>new</b> A50U SDUCR/L 11                         | ●                      | ○ | 50  | 50   | 47   | 80     | 350 | 35  | ≥63  |   |   |                             |   |  |

R: Sağ / Right / Rechts L: Sol / Left / Links

● Stokta / In Stock / Auf Lager ○ Stokta Yok / Non Stock Item / Kein Lagerartikel, Lieferzeit auf Anfrage

Sipariş Örneği/Ordering Example/Bestellbeispiel  
1 ad./pcs./stück S0810K SDUCR 07

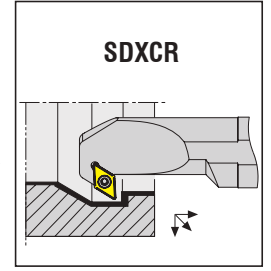
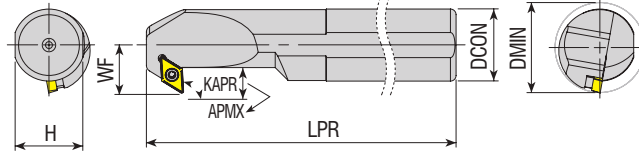

**Takım Kodu**  
**Ordering Code**  
**Bestell-Bezeichnung**

Stok  
Stock  
Lager

Takım Ölçüleri (mm)  
Dimension (mm)  
Abmessung (mm)

Kesici Uç  
Insert  
Wendeschneidplatte

Yedek Parçaları / Spare Parts / Ersatzteile

Sıkma Vidası  
Screw  
Klemmschraube

Altık  
Shim  
Unterlage

Altık Vidası  
Shim Screw  
Schraube für Unterlage

Tork Anahtar  
Torx Key  
Torx (Innensechskantschlüssel)

R L DCON H LPR WF APMX DMIN

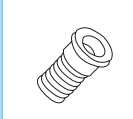
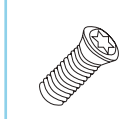

|                 |    |    |      |     |    |      |     |             |              |             |                |        |
|-----------------|----|----|------|-----|----|------|-----|-------------|--------------|-------------|----------------|--------|
| S12K SDXCR/L 07 | ●● | 12 | 11   | 125 | 09 | 4.5  | ≥16 | DC.T 0702.. | 4008-M2.5x6  | -           | -              | 82-T08 |
| S16P SDXCR/L 07 | ●● | 16 | 14.8 | 170 | 11 | 6.5  | ≥20 |             |              |             |                |        |
| S20R SDXCR/L 07 | ●● | 20 | 18.3 | 200 | 13 | 6.5  | ≥25 | DC.T 11T3.. | 4015-M3.5x9  | -           | -              | 80-T15 |
| S16P SDXCR/L 11 | ●● | 16 | 14.8 | 170 | 11 | 6.5  | ≥20 |             |              |             |                |        |
| S20R SDXCR/L 11 | ●● | 20 | 18.3 | 200 | 14 | 7.5  | ≥25 |             |              |             |                |        |
| S25S SDXCR/L 11 | ●● | 25 | 23   | 250 | 17 | 9    | ≥32 |             |              |             |                |        |
| S32T SDXCR/L 11 | ●● | 32 | 30   | 300 | 22 | 12.5 | ≥40 |             |              |             |                |        |
| S40U SDXCR/L 11 | ●● | 40 | 37.5 | 350 | 27 | 14.5 | ≥50 |             |              |             |                |        |
| A12H SDXCR/L 07 | ●● | 12 | 11   | 100 | 09 | 4.5  | ≥16 |             |              |             |                |        |
| A16M SDXCR/L 07 | ●● | 16 | 14.8 | 150 | 11 | 6.5  | ≥20 | DC.T 0702.. | 4008-M2.5x6  | -           | -              | 82-T08 |
| A20P SDXCR/L 07 | ●● | 20 | 18.3 | 170 | 13 | 6.5  | ≥25 | DC.T 11T3.. | 4015-M3.5x11 | -           | -              | 80-T15 |
| A16M SDXCR/L 11 | ●● | 16 | 14.8 | 150 | 11 | 7.5  | ≥20 |             |              |             |                |        |
| A20P SDXCR/L 11 | ●● | 20 | 18.3 | 170 | 14 | 7.5  | ≥25 |             |              |             |                |        |
| A25R SDXCR/L 11 | ●● | 25 | 23   | 200 | 17 | 9    | ≥32 |             |              |             |                |        |
| A32S SDXCR/L 11 | ●● | 32 | 30   | 250 | 22 | 12.5 | ≥40 |             |              |             |                |        |
|                 |    |    |      |     |    |      |     |             |              | AADN-2-0001 | AAV-08-M3.5x8  |        |
|                 |    |    |      |     |    |      |     |             |              |             | AAV-06-M3.5x11 |        |

R: Sağ / Right / Rechts L: Sol / Left / Links

● Stokta / In Stock / Auf Lager ○ Stokta Yok / Non Stock Item / Kein Lagerartikel, Lieferzeit auf Anfrage

Not: "APMX" ölçüleri R0.4'e göre verilmiştir.

Note: Dimensions of "APMX" are given according to R0.4

Hinweis: Das Maß "APMX" bezieht sich auf R0.4

Sipariş Örneği/Ordering Example/Bestellbeispiel

1 ad./pcs./stück S12K SDXCR 07



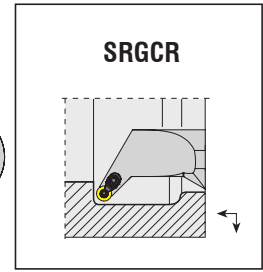
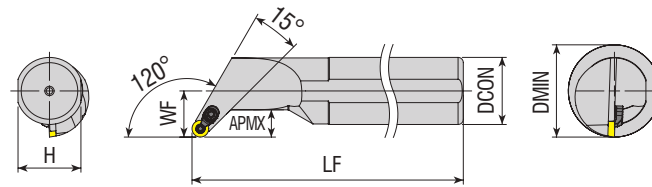

**Takım Kodu**  
**Ordering Code**  
*Bestell-Bezeichnung*

| Stok<br>Stock<br>Lager  | Takım Ölçüleri (mm)<br>Dimension (mm)<br>Abmessung (mm) |   |      |      |     |    |      | Kesici Uç<br>Insert<br>Wendeschneidplatte | Yedek Parçaları / Spare Parts / Ersatzteile |  |                             |   |   |   |   |
|-------------------------|---|---|------|------|-----|----|------|---|---|--|-----------------------------|---|---|---|---|
|                         | R   | L | DCON | H    | LF  | WF | APMX |   | DMIN  | Sıkma Vidası<br>Screw<br>Klemmschraube | Altlık<br>Shim<br>Unterlage | Altlık Vidası<br>Shim Screw<br>Schraube für Unterlage | Baskı Pabucu<br>Shim Screw<br>Spannpratze | Pabuç Vidası<br>Shim Screw<br>Klemmschraube | Anahtar<br>Allen Key<br>Innensechskantschlüssel |
|                         | ●   | ○ | 16   | 14.8 | 170 | 11 | 7    | ≥22                                       | RCM. 0803..                                 | 3008-M3x8                              | -                           | -   | ACK-15                                    | 4015-M3.5x11                                | 82-T08  |
| <b>S16P SRGCR/L 08</b>  | ●   | ○ | 16   | 14.8 | 170 | 11 | 7    | ≥22                                       |   |  |                             |   |   |   |   |
| <b>S20R SRGCR/L 08</b>  | ●   | ● | 20   | 18.3 | 200 | 13 | 7    | ≥26                                       |   |  |                             |   |   |   |   |
| <b>S25S SRGCR/L 08C</b> | ●   | ● | 25   | 23   | 250 | 17 | 9.5  | ≥34                                       |   |  |                             |   |   |   |   |
| <b>S32T SRGCR/L 08C</b> | ●   | ○ | 32   | 30   | 300 | 22 | 13   | ≥44                                       |   |  |                             |   |   |   |   |
| <b>S40U SRGCR/L 08C</b> | ●   | ○ | 40   | 37.5 | 350 | 27 | 15   | ≥54                                       |   |  |                             |   |   |   |   |
| <b>A16M SRGCR/L 08</b>  | ●   | ● | 16   | 14.8 | 150 | 11 | 7    | ≥22                                       |   |  |                             |   |   |   |   |
| <b>A20P SRGCR/L 08</b>  | ●   | ● | 20   | 18.3 | 170 | 13 | 7    | ≥26                                       |   |  |                             |   |   |   |   |
| <b>A25R SRGCR/L 08C</b> | ●   | ● | 25   | 23   | 200 | 17 | 9.5  | ≥34                                       |   |  |                             |   |   |   |   |
| <b>A32S SRGCR/L 08C</b> | ●   | ● | 32   | 30   | 250 | 22 | 13   | ≥44                                       |   |  |                             |   |   |   |   |
| <b>A40T SRGCR/L 08C</b> | ●   | ● | 40   | 37.5 | 300 | 27 | 15   | ≥54                                       |   |  |                             |   |   |   |   |



KAPR=45°

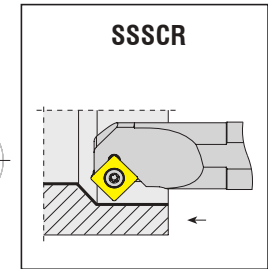
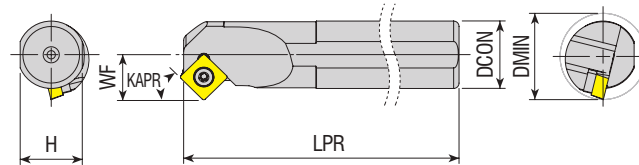

**Takım Kodu**  
**Ordering Code**  
*Bestell-Bezeichnung*

| Stok<br>Stock<br>Lager | Takım Ölçüleri (mm)<br>Dimension (mm)<br>Abmessung (mm) |   |      |      |     |    |      | Kesici Uç<br>Insert<br>Wendeschneidplatte | Yedek Parçaları / Spare Parts / Ersatzteile |                             |   |  |
|------------------------|---|---|------|------|-----|----|------|---|---|-----------------------------|---|--|
|                        | R   | L | DCON | H    | LPR | WF | DMIN |   | Sıkma Vidası<br>Screw<br>Klemmschraube      | Altlık<br>Shim<br>Unterlage | Altlık Vidası<br>Shim Screw<br>Schraube für Unterlage | Tork Anahtar<br>Torx Key<br>Torx Innensechskantschlüssel |
|                        | ●   | ● | 16   | 14.8 | 170 | 11 | ≥20  | SC.T 09T3..                               | 4015-M3.5x9                                 | -                           | -   | 80-T15   |
| <b>S16P SSSCR/L 09</b> | ●   | ● | 16   | 14.8 | 170 | 11 | ≥20  |   |   |                             |   |  |
| <b>S20R SSSCR/L 09</b> | ●   | ● | 20   | 18.3 | 200 | 13 | ≥25  |   |   |                             |   |  |
| <b>S25S SSSCR/L 09</b> | ●   | ● | 25   | 23   | 250 | 17 | ≥32  | SC.T 1204..                               | 4015-M3.5x11                                | AASN-2-0001                 | AAV-08-M3.5x8   | 80-T20   |
| <b>S25S SSSCR/L 12</b> | ●   | ● | 25   | 23   | 250 | 17 | ≥32  |   |   |                             |   |  |
| <b>S32T SSSCR/L 12</b> | ●   | ○ | 32   | 30   | 300 | 22 | ≥40  |   |   |                             |   |  |
| <b>S40U SSSCR/L 12</b> | ●   | ○ | 40   | 37.5 | 350 | 27 | ≥50  |   |   |                             |   |  |

R: Sağ / Right / Rechts L: Sol / Left / Links

● Stokta / In Stock / Auf Lager ○ Stokta Yok / Non Stock Item / Kein Lagerartikel, Lieferzeit auf Anfrage

Sipariş Örneği/Ordering Example/Bestellbeispiel

1 ad./pcs./stück S16P SRGCR 08



KAPR=60°

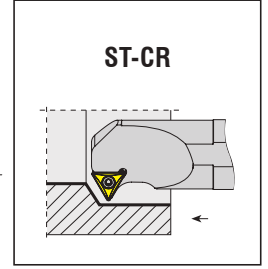
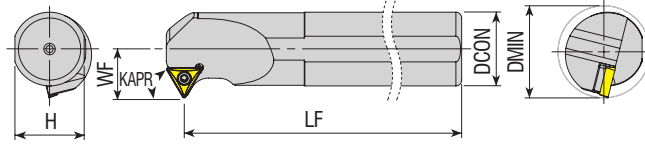

ST-CR

| Takım Kodu<br>Ordering Code<br>Bestell-Bezeichnung | Stok<br>Stock<br>Lager |   | Takım Ölçüleri (mm)<br>Dimension (mm)<br>Abmessung (mm) |      |     |    |      | Kesici Uç<br>Insert<br>Wendeschneidplatte | Yedek Parçaları / Spare Parts / Ersatzteile |                                 |   |  |
|--|------------------------|---|---|------|-----|----|------|---|---|---------------------------------|---|--|
|  | R                      | L | DCON  | H    | LF  | WF | DMIN |   | Sıkma Vidası<br>Screw<br>Klemmschraube      | Altlık<br>Shim<br>Unterlage     | Altlık Vidası<br>Shim Screw<br>Schraube für Unterlage | Tork Anahtar<br>Torx Key<br>Torx Innensechskantschlüssel |
| S12K ST-CR/L 11                                    | ●                      | ● | 12  | 11   | 125 | 09 | ≥17  | TC.T 1102..                               | 4008-M2.5x6                                 | -                               | -   | 82-T08   |
| S16P ST-CR/L 11                                    | ●                      | ○ | 16  | 14.8 | 170 | 11 | ≥20  |   |   |                                 |   |  |
| S20R ST-CR/L 11                                    | ●                      | ○ | 20  | 18.3 | 200 | 13 | ≥25  | TC.T 16T3..                               | 4015-M3.5x9<br>4015-M3.5x11                 | -                               | -   | 80-T15   |
| S16P ST-CR/L 16                                    | ●                      | ● | 16  | 14.8 | 170 | 11 | ≥20  |   |   |                                 |   |  |
| S20R ST-CR/L 16                                    | ●                      | ● | 20  | 18.3 | 200 | 13 | ≥25  | 4015-M3.5x14                              | AATN-2-0001                                 | AAV-08-M3.5x8<br>AAV-06-M3.5x11 | 80-T15  |  |
| S25S ST-CR/L 16                                    | ●                      | ● | 25  | 23   | 250 | 17 | ≥32  |   |   |                                 |   |  |
| S32T ST-CR/L 16                                    | ●                      | ● | 32  | 30   | 300 | 22 | ≥40  | 4015-M3.5x14                              | AATN-2-0001                                 | AAV-06-M3.5x11                  | 80-T15  |  |
| S40U ST-CR/L 16                                    | ●                      | ● | 40  | 37.5 | 350 | 27 | ≥50  |   |   |                                 |   |  |



KAPR=90°

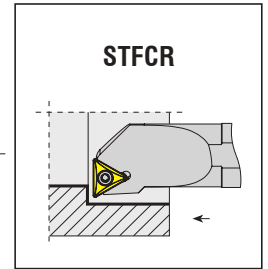
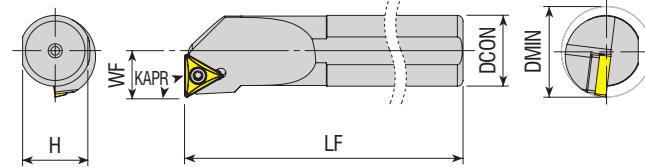

STFCL

| Takım Kodu<br>Ordering Code<br>Bestell-Bezeichnung | Stok<br>Stock<br>Lager |   | Takım Ölçüleri (mm)<br>Dimension (mm)<br>Abmessung (mm) |      |     |     |      | Kesici Uç<br>Insert<br>Wendeschneidplatte | Yedek Parçaları / Spare Parts / Ersatzteile |                                 |   |  |
|--|------------------------|---|---|------|-----|-----|------|---|---|---------------------------------|---|--|
|  | R                      | L | DCON  | H    | LF  | WF  | DMIN |   | Sıkma Vidası<br>Screw<br>Klemmschraube      | Altlık<br>Shim<br>Unterlage     | Altlık Vidası<br>Shim Screw<br>Schraube für Unterlage | Tork Anahtar<br>Torx Key<br>Torx Innensechskantschlüssel |
| S0610F STFCL/L 06                                  | ●                      | ● | 10  | 09   | 80  | 4.5 | ≥08  | TC.T 06T1..                               | 3006-M2x4                                   | -                               | -   | 82-T06   |
| S08H STFCL/L 06                                    | ●                      | ● | 08  | 7.3  | 100 | 06  | ≥11  |   |   |                                 |   |  |
| S10K STFCL/L 09                                    | ●                      | ● | 10  | 09   | 125 | 07  | ≥13  | TC.T 0902..                               | 3007-M2.2x4.6                               | -                               | -   | 82-T07   |
| S12K STFCL/L 09                                    | ●                      | ● | 12  | 11   | 125 | 09  | ≥17  |   |   |                                 |   |  |
| S12K STFCL/L 11                                    | ●                      | ● | 12  | 11   | 125 | 09  | ≥17  | TC.T 1102..                               | 4008-M2.5x6                                 | -                               | -   | 82-T08   |
| S16P STFCL/L 11                                    | ●                      | ● | 16  | 14.8 | 170 | 11  | ≥20  |   |   |                                 |   |  |
| S20R STFCL/L 11                                    | ●                      | ● | 20  | 18.3 | 200 | 13  | ≥25  | 4015-M3.5x9<br>4015-M3.5x11               | -   | -                               | 80-T15  |  |
| S16P STFCL/L 16                                    | ●                      | ● | 16  | 14.8 | 170 | 11  | ≥20  |   |   |                                 |   |  |
| S20R STFCL/L 16                                    | ●                      | ● | 20  | 18.3 | 200 | 13  | ≥25  | 4015-M3.5x14                              | AATN-2-0001                                 | AAV-08-M3.5x8<br>AAV-06-M3.5x11 | 80-T15  |  |
| S25S STFCL/L 16                                    | ●                      | ● | 25  | 23   | 250 | 17  | ≥32  |   |   |                                 |   |  |
| S32T STFCL/L 16                                    | ●                      | ● | 32  | 30   | 300 | 22  | ≥40  | 4015-M3.5x14                              | AATN-2-0001                                 | AAV-06-M3.5x11                  | 80-T15  |  |
| S40U STFCL/L 16                                    | ●                      | ○ | 40  | 37.5 | 350 | 27  | ≥50  |   |   |                                 |   |  |
| A10H STFCL/L 11                                    | ●                      | ● | 10  | 09   | 100 | 07  | ≥13  | TC.T 1102..                               | 4008-M2.5x6                                 | -                               | -   | 82-T08   |
| A12H STFCL/L 11                                    | ●                      | ● | 12  | 11   | 100 | 09  | ≥17  |   |   |                                 |   |  |
| A16M STFCL/L 11                                    | ●                      | ● | 16  | 14.8 | 150 | 11  | ≥20  |   |   |                                 |   |  |

R: Sağ / Right / Rechts L: Sol / Left / Links

● Stokta / In Stock / Auf Lager ○ Stokta Yok / Non Stock Item / Kein Lagerartikel, Lieferzeit auf Anfrage

Sipariş Örneği/Ordering Example/Bestellbeispiel

1 ad./pcs./stück S12K ST-CR 11

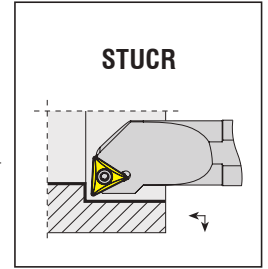
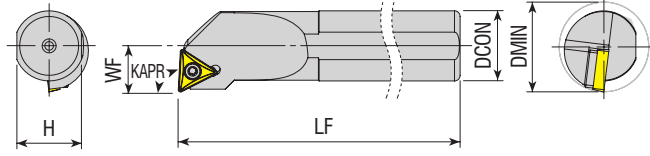

**Takım Kodu**  
**Ordering Code**  
**Bestell-Bezeichnung**

Stok  
Stock  
Lager

Takım Ölçüleri (mm)  
Dimension (mm)  
Abmessung (mm)

Kesici Uç  
Insert  
Wendeschneidplatte

Sıkma Vidası  
Screw  
Klemmschraube

Yedek Parçaları / Spare Parts / Ersatzteile

Altık  
Shim  
Unterlage

Altık Vidası  
Shim Screw  
Schraube für Unterlage

Tork Anahtar  
Torx Key  
Torx Innenschlüssel

R L DCON H LF WF DMIN



S10K STUCR/L 09

●● 10 09 125 07 ≥13

TC.T 0902..

3007-M2.2x4.6

S12K STUCR/L 09

●● 12 11 125 09 ≥16

S12K STUCR/L 11

●● 12 11 125 09 ≥17

S16P STUCR/L 11

●● 16 14.8 170 11 ≥20

TC.T 1102..

4008-M2.5x6

S20R STUCR/L 11

●● 20 18.3 200 13 ≥25

S16P STUCR/L 16

●● 16 14.8 170 11 ≥20

S20R STUCR/L 16

●● 20 18.3 200 13 ≥25

S25S STUCR/L 16

●● 25 23 250 17 ≥32

TC.T 16T3..

4015-M3.5x9

S32T STUCR/L 16

●● 32 30 300 22 ≥40

S40U STUCR/L 16

●● 40 37.5 350 27 ≥50

A10H STUCR/L 09

●● 10 09 100 07 ≥13

TC.T 0902..

3007-M2.2x4.6

A12H STUCR/L 09

●● 12 11 100 09 ≥16

A12H STUCR/L 11

●● 12 11 100 09 ≥16

A16M STUCR/L 11

●● 16 14.8 150 11 ≥20

TC.T 1102..

4008-M2.5x6

A20P STUCR/L 11

●● 20 18.3 170 13 ≥25

A16M STUCR/L 16

●● 16 14.8 150 11 ≥20

A20P STUCR/L 16

●● 20 18.3 170 13 ≥25

A25R STUCR/L 16

●● 25 23 200 17 ≥32

TC.T 16T3..

4015-M3.5x14

A32S STUCR/L 16

●● 32 30 250 22 ≥40

4015-M3.5x11

AATN-2-0001

AAV-08-M3.5x8

AAV-06-M3.5x11

R: Sağ / Right / Rechts L: Sol / Left / Links

● Stokta / In Stock / Auf Lager ○ Stokta Yok / Non Stock Item / Kein Lagerartikel, Lieferzeit auf Anfrage

Sipariş Örneği/Ordering Example/Bestellbeispiel

1 ad./pcs./stück S10K STUCR 09





KAPR=93°

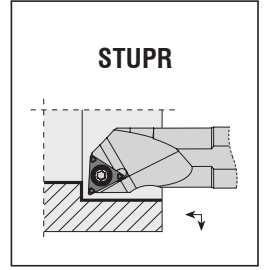
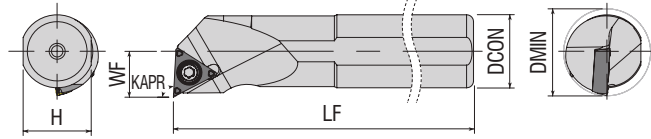

STUPR

| Takım Kodu<br>Ordering Code<br>Bestell-Bezeichnung | Stok<br>Stock<br>Lager |   | Takım Ölçüleri (mm)<br>Dimension (mm)<br>Abmessung (mm) |      |     |    | Kesici Uç<br>Insert<br>Wendeschneidplatte | Yedek Parçaları / Spare Parts / Ersatzteile |  |                             |   |  |
|--|------------------------|---|---|------|-----|----|---|---|--|-----------------------------|---|--|
|  | R                      | L | DCON  | H    | LF  | WF |   | DMIN  | Sıkma Vidası<br>Screw<br>Klemmschraube | Altlık<br>Shim<br>Unterlage | Altlık Vidası<br>Shim Screw<br>Schraube für Unterlage | Tork Anahtar<br>Torx Key<br>Torx Innensechskantschlüssel |
| S08H STUPR/L 0802                                  | ●                      | ○ | 08  | 7.3  | 100 | 05 | ≥10                                       | TP. 0802..                                  | 3006-M2x4                              |                             |   | 82-T06   |
| S10K STUPR/L 1103                                  | ●                      | ○ | 10  | 09   | 125 | 06 | ≥12                                       |   | TP. 1103..                             | 4010-M3x6                   |   |  |
| S12K STUPR/L 1103                                  | ●                      | ○ | 12  | 11   | 125 | 08 | ≥16                                       |   |  |                             |   |  |
| S12M STUPR/L 1103                                  | ●                      | ○ | 12  | 11   | 150 | 08 | ≥16                                       |   |  |                             |   |  |
| S16P STUPR/L 1103                                  | ●                      | ○ | 16  | 14.8 | 170 | 10 | ≥20                                       |   |  |                             |   |  |
| S16R STUPR/L 1103                                  | ●                      | ○ | 16  | 14.8 | 200 | 10 | ≥20                                       |   | 4010-M3x8                              |                             |   |  |
| A20R STUPR/L 1103                                  | ●                      | ○ | 20  | 18.3 | 200 | 13 | ≥25                                       |   |  |                             |   |  |



KAPR=93°

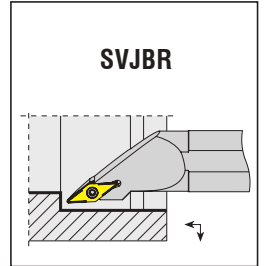
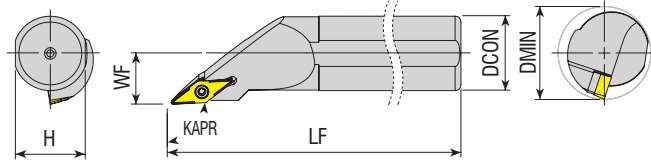

SVJBR

| Takım Kodu<br>Ordering Code<br>Bestell-Bezeichnung | Stok<br>Stock<br>Lager |   | Takım Ölçüleri (mm)<br>Dimension (mm)<br>Abmessung (mm) |      |     |    | Kesici Uç<br>Insert<br>Wendeschneidplatte | Yedek Parçaları / Spare Parts / Ersatzteile |  |                             |   |  |
|--|------------------------|---|---|------|-----|----|---|---|--|-----------------------------|---|--|
|  | R                      | L | DCON  | H    | LF  | WF |   | DMIN  | Sıkma Vidası<br>Screw<br>Klemmschraube | Altlık<br>Shim<br>Unterlage | Altlık Vidası<br>Shim Screw<br>Schraube für Unterlage | Tork Anahtar<br>Torx Key<br>Torx Innensechskantschlüssel |
| S25S SVJBR/L 16                                    | ●                      | ● | 25  | 23   | 250 | 17 | ≥32                                       | VB.T 1604..                                 | 4015-M3.5x12                           | AAVN-2-0002                 | AAV-08-M3.5x8   | 80-T15   |
| S32T SVJBR/L 16                                    | ●                      | ● | 32  | 30   | 300 | 22 | ≥40                                       |   | 4015-M3.5x14                           |                             | AAV-06-M3.5x11  |  |
| S40U SVJBR/L 16                                    | ●                      | ● | 40  | 37.5 | 350 | 27 | ≥50                                       |   |  |                             |   |  |

R: Sağ / Right / Rechts L: Sol / Left / Links  
● Stokta / In Stock / Auf Lager ○ Stokta Yok / Non Stock Item / Kein Lagerartikel, Lieferzeit auf Anfrage

Sipariş Örneği/Ordering Example/Bestellbeispiel  
1 ad./pcs./stück S08H STUPR 0802



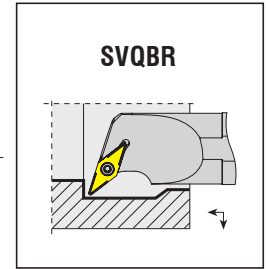
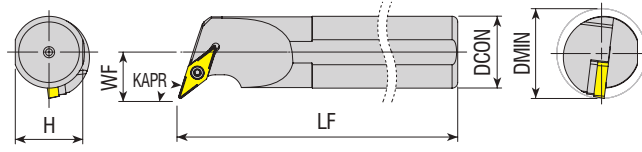

**Takım Kodu**  
**Ordering Code**  
**Bestell-Bezeichnung**

| Stok<br>Stock<br>Lager | Takım Ölçüleri (mm)<br>Dimension (mm)<br>Abmessung (mm) |   |      |      |     |    | Kesici Uç<br>Insert<br>Wendeschneidplatte | Yedek Parçaları / Spare Parts / Ersatzteile |  |                            |  |  |
|------------------------|---|---|------|------|-----|----|---|---|--|----------------------------|--|--|
|                        | R   | L | DCON | H    | LF  | WF |   | DMIN  | Sıkma Vidası<br>Screw<br>Klemmschraube | Altık<br>Shim<br>Unterlage | Altık Vidası<br>Shim Screw<br>Schraube für Unterlage | Tork Anahtar<br>Torx Key<br>Torx Innensechskantschlüssel |
|                        | R   | L | DCON | H    | LF  | WF | DMIN                                      |   |  |                            |  |  |
| S16P SVQBR/L 11        | ●   | ● | 16   | 14.8 | 170 | 11 | ≥20                                       | VB.T 1103..                                 | 4008-M2.5x6                            | -                          | -  | 82-T08   |
| S20R SVQBR/L 11        | ●   | ● | 20   | 18.3 | 200 | 13 | ≥25                                       | VB.T 1103..                                 | 4008-M2.5x6                            | -                          | -  | 82-T08   |
| S25S SVQBR/L 16        | ●   | ● | 25   | 23   | 250 | 17 | ≥32                                       | VB.T 1604..                                 | 4015-M3.5x14                           | AAVN-2-0002                | AAV-08-M3.5x8  | 80-T15   |
| S32T SVQBR/L 16        | ●   | ● | 32   | 30   | 300 | 22 | ≥40                                       | VB.T 1604..                                 | 4015-M3.5x14                           | AAVN-2-0002                | AAV-06-M3.5x11                                       | 80-T15   |
| S40U SVQBR/L 16        | ●   | ● | 40   | 37.5 | 350 | 27 | ≥50                                       | VB.T 1604..                                 | 4015-M3.5x14                           | AAVN-2-0002                | AAV-06-M3.5x11                                       | 80-T15   |
| A20Q SVQBR/L 11        | ●   | ● | 20   | 18.5 | 180 | 13 | ≥25                                       | VB.T 1103..                                 | 4008-M2.5x6                            | -                          | -  | 82-T08   |
| A20Q SVQBR/L 16        | ●   | ● | 20   | 18.5 | 180 | 20 | ≥30                                       | VB.T 1103..                                 | 4015-M3.5x11                           | -                          | -  | 82-T08   |
| A25S SVQBR/L 16        | ●   | ● | 25   | 23   | 250 | 17 | ≥32                                       | VB.T 1604..                                 | 4015-M3.5x14                           | AAVN-2-0002                | AAV-06-M3.5x11                                       | 80-T15   |
| A32S SVQBR/L 16        | ●   | ● | 32   | 30   | 250 | 22 | ≥40                                       | VB.T 1604..                                 | 4015-M3.5x14                           | AAVN-2-0002                | AAV-06-M3.5x11                                       | 80-T15   |

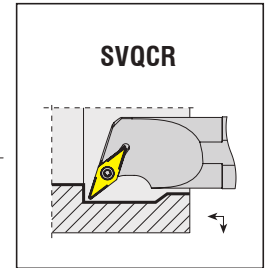
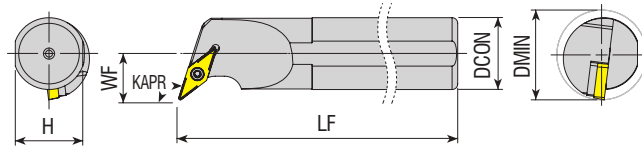

**Takım Kodu**  
**Ordering Code**  
**Bestell-Bezeichnung**

| Stok<br>Stock<br>Lager | Takım Ölçüleri (mm)<br>Dimension (mm)<br>Abmessung (mm) |   |      |      |     |    | Kesici Uç<br>Insert<br>Wendeschneidplatte | Yedek Parçaları / Spare Parts / Ersatzteile |  |                            |  |  |
|------------------------|---|---|------|------|-----|----|---|---|--|----------------------------|--|--|
|                        | R   | L | DCON | H    | LF  | WF |   | DMIN  | Sıkma Vidası<br>Screw<br>Klemmschraube | Altık<br>Shim<br>Unterlage | Altık Vidası<br>Shim Screw<br>Schraube für Unterlage | Tork Anahtar<br>Torx Key<br>Torx Innensechskantschlüssel |
|                        | R   | L | DCON | H    | LF  | WF | DMIN                                      |   |  |                            |  |  |
| S16P SVQCR/L 11        | ●   | ● | 16   | 14.8 | 170 | 11 | ≥20                                       | VC.T 1103..                                 | 4008-M2.5x6                            | -                          | -  | 82-T08   |
| S20R SVQCR/L 11        | ●   | ● | 20   | 18.3 | 200 | 13 | ≥25                                       | VC.T 1103..                                 | 4008-M2.5x6                            | -                          | -  | 82-T08   |
| S25S SVQCR/L 16        | ●   | ● | 25   | 23   | 250 | 17 | ≥32                                       | VC.T 1604..                                 | 4015-M3.5x14                           | AAVN-2-0002                | AAV-08-M3.5x8  | 80-T15   |
| S32T SVQCR/L 16        | ●   | ● | 32   | 30   | 300 | 22 | ≥40                                       | VC.T 1604..                                 | 4015-M3.5x14                           | AAVN-2-0002                | AAV-06-M3.5x11                                       | 80-T15   |
| S40U SVQCR/L 16        | ●   | ● | 40   | 37.5 | 350 | 27 | ≥50                                       | VC.T 1604..                                 | 4015-M3.5x14                           | AAVN-2-0002                | AAV-06-M3.5x11                                       | 80-T15   |
| A16M SVQCR/L 11        | ●   | ● | 16   | 14.8 | 150 | 11 | ≥20                                       | VC.T 1103..                                 | 4008-M2.5x6                            | -                          | -  | 82-T08   |
| A20P SVQCR/L 11        | ●   | ● | 20   | 18.3 | 170 | 13 | ≥25                                       | VC.T 1103..                                 | 4008-M2.5x6                            | -                          | -  | 82-T08   |
| A25R SVQCR/L 16        | ●   | ● | 25   | 23   | 200 | 17 | ≥32                                       | VC.T 1604..                                 | 4015-M3.5x14                           | AAVN-2-0002                | AAV-08-M3.5x8  | 80-T15   |
| A32S SVQCR/L 16        | ●   | ● | 32   | 30   | 250 | 22 | ≥40                                       | VC.T 1604..                                 | 4015-M3.5x14                           | AAVN-2-0002                | AAV-06-M3.5x11                                       | 80-T15   |
| A40T SVQCR/L 16        | ●   | ● | 40   | 37.5 | 300 | 27 | ≥50                                       | VC.T 1604..                                 | 4015-M3.5x14                           | AAVN-2-0002                | AAV-06-M3.5x11                                       | 80-T15   |

R: Sağ / Right / Rechts L: Sol / Left / Links

● Stokta / In Stock / Auf Lager ○ Stokta Yok / Non Stock Item / Kein Lagerartikel, Lieferzeit auf Anfrage

Sipariş Örneği/Ordering Example/Bestellbeispiel  
1 ad./pcs./stück S16P SVQBR 11

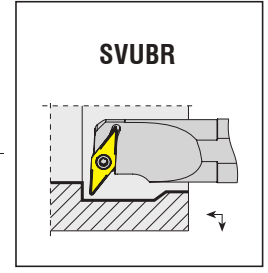
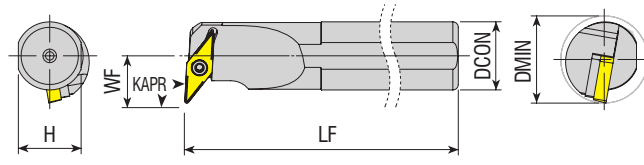

**Takım Kodu**  
**Ordering Code**  
**Bestell-Bezeichnung**

| Stok<br>Stock<br>Lager | Takım Ölçüleri (mm)<br>Dimension (mm)<br>Abmessung (mm) |    |      |     |      |     | Kesici Uç<br>Insert<br>Wendeschneidplatte | Yedek Parçaları / Spare Parts / Ersatzteile |  |                         |  |
|------------------------|---|----|------|-----|------|-----|---|---|--|-------------------------|--|
|                        | R   | L  | DCON | H   | LF   | WF  |   | DMIN  | Sıkma Vidası<br>Screw<br>Klemmschraube | Altık Shim<br>Unterlage | Altık Vidası<br>Shim Screw<br>Schraube für Unterlage |
| ●                      | ●   | 16 | 14.8 | 170 | 12.5 | ≥20 | VB.T 1103..                               | 4008-M2.5x6                                 | -                                      | -                       | 82-T08   |
| ●                      | ●   | 20 | 18.3 | 200 | 13   | ≥25 |   |   |  |                         |  |
| ●                      | ●   | 25 | 23   | 250 | 19   | ≥32 | VB.T 1604..                               | 4015-M3.5x14                                | AAVN-2-0002                            | AAV-06-M3.5x11          | 80-T15   |
| ●                      | ●   | 32 | 30   | 300 | 22   | ≥40 |   |   |  |                         |  |
| ●                      | ○   | 40 | 37.5 | 350 | 27   | ≥50 |   |   |  |                         |  |
| ●                      | ○   | 20 | 18.3 | 180 | 20   | ≥30 |   | 4015-M3.5x11                                | -                                      | -                       |  |
| ●                      | ●   | 32 | 30   | 250 | 22   | ≥40 |   | 4015-M3.5x14                                | AAVN-2-0002                            | AAV-06-M3.5x11          |  |

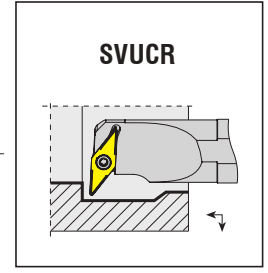
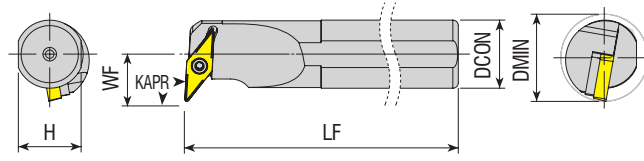

**Takım Kodu**  
**Ordering Code**  
**Bestell-Bezeichnung**

| Stok<br>Stock<br>Lager | Takım Ölçüleri (mm)<br>Dimension (mm)<br>Abmessung (mm) |    |      |     |      |     | Kesici Uç<br>Insert<br>Wendeschneidplatte | Yedek Parçaları / Spare Parts / Ersatzteile |  |                         |  |
|------------------------|---|----|------|-----|------|-----|---|---|--|-------------------------|--|
|                        | R   | L  | DCON | H   | LF   | WF  |   | DMIN  | Sıkma Vidası<br>Screw<br>Klemmschraube | Altık Shim<br>Unterlage | Altık Vidası<br>Shim Screw<br>Schraube für Unterlage |
| ●                      | ●   | 16 | 14.8 | 170 | 12.5 | ≥20 | VC.T 1103..                               | 4008-M2.5x6                                 | -                                      | -                       | 82-T08   |
| ●                      | ●   | 20 | 18.3 | 200 | 13   | ≥25 |   |   |  |                         |  |
| ●                      | ●   | 25 | 23   | 250 | 19   | ≥32 | VC.T 1604..                               | 4015-M3.5x14                                | AAVN-2-0002                            | AAV-06-M3.5x11          | 80-T15   |
| ●                      | ●   | 32 | 30   | 300 | 22   | ≥40 |   |   |  |                         |  |
| ●                      | ●   | 40 | 37.5 | 350 | 27   | ≥50 |   |   |  |                         |  |
| ●                      | ●   | 12 | 11   | 125 | 9    | ≥16 | VC.T 0702..                               | 3006-M2x4                                   | -                                      | -                       | 82-T06   |
| ●                      | ○   | 20 | 18.3 | 170 | 13   | ≥25 | VC.T 1103..                               | 4008-M2.5x6                                 | -                                      | -                       | 82-T08   |
| ●                      | ●   | 20 | 18.3 | 180 | 13   | ≥25 | VC.T 1103..                               | 4008-M2.5x6                                 | -                                      | -                       | 82-T08   |
| ●                      | ●   | 25 | 23   | 200 | 19   | ≥32 | VC.T 1604..                               | 4015-M3.5x14                                | AAVN-2-0002                            | AAV-06-M3.5x11          | 80-T15   |

R: Sağ / Right / Rechts L: Sol / Left / Links  
● Stokta / In Stock / Auf Lager ○ Stokta Yok / Non Stock Item / Kein Lagerartikel, Lieferzeit auf Anfrage

Sipariş Örneği/Ordering Example/Bestellbeispiel  
1 ad./pcs./stück S16P SVUBR 11

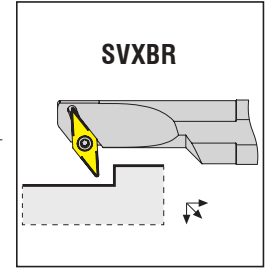
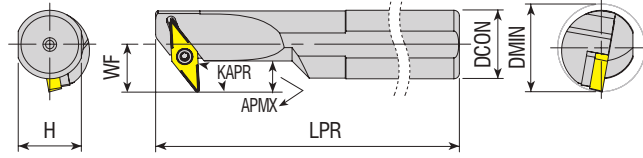

| Takım Kodu<br>Ordering Code<br>Bestell-Bezeichnung | Stok<br>Stock<br>Lager |   | Takım Ölçüleri (mm)<br>Dimension (mm)<br>Abmessung (mm) |      |     |      |      | Kesici Uç<br>Insert<br>Wendeschneidplatte | Yedek Parçaları / Spare Parts / Ersatzteile |  |                             |   |  |
|--|------------------------|---|---|------|-----|------|------|---|---|--|-----------------------------|---|--|
|  | R                      | L | DCON  | H    | LPR | WF   | APMX |   | DMIN  | Sıkma Vidası<br>Screw<br>Klemmschraube | Altlık<br>Shim<br>Unterlage | Altlık Vidası<br>Shim Screw<br>Schraube für Unterlage | Tork Anahtar<br>Torx Key<br>Torx Innensechskantschlüssel |
| <b>S16P SVXBR/L 1102</b>                           | ●                      | ○ | 16  | 14.8 | 170 | 12.5 | 7.2  | ≥20                                       | <b>VBM. 1102..</b>                          | 4008-M2.5x6                            | -                           | -   | 82-T08   |
| <b>S20R SVXBR/L 1102</b>                           | ●                      | ● | 20  | 18.3 | 200 | 13   | 5.7  | ≥25                                       |   |  |                             |   |  |
| <b>S16P SVXBR/L 11</b>                             | ●                      | ● | 16  | 14.8 | 170 | 12.5 | 7.2  | ≥20                                       | <b>VB.T 1103..</b>                          |  |                             |   |  |
| <b>S20R SVXBR/L 11</b>                             | ●                      | ● | 20  | 18.3 | 200 | 13   | 5.7  | ≥25                                       |   |  |                             |   |  |
| <b>S25S SVXBR/L 16</b>                             | ●                      | ● | 25  | 23   | 250 | 19   | 10.2 | ≥32                                       | <b>VB.T 1604..</b>                          | 4015-M3.5x14                           | AAVN-2-0002                 | AAV-06-M3.5x11  | 80-T15   |
| <b>S32T SVXBR/L 16</b>                             | ●                      | ● | 32  | 30   | 300 | 22   | 11.7 | ≥40                                       |   |  |                             |   |  |
| <b>S40U SVXBR/L 16</b>                             | ●                      | ● | 40  | 37.5 | 350 | 27   | 14.3 | ≥50                                       |   |  |                             |   |  |

Not: "APMX" ölçüleri R0.4'e göre verilmiştir.  
Note: Dimensions of "APMX" are given according to R0.4  
Hinweis: Das Maß "APMX" bezieht sich auf R 0,4

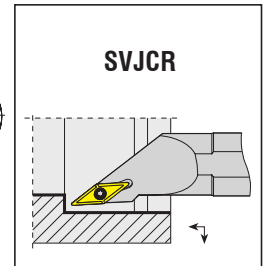
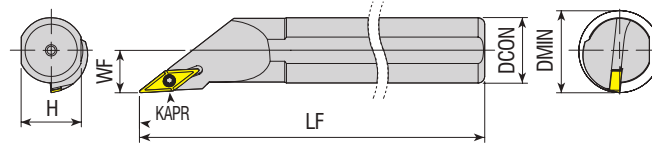

| Takım Kodu<br>Ordering Code<br>Bestell-Bezeichnung | Stok<br>Stock<br>Lager |   | Takım Ölçüleri (mm)<br>Dimension (mm)<br>Abmessung (mm) |      |     |    |      | Kesici Uç<br>Insert<br>Wendeschneidplatte | Yedek Parçaları / Spare Parts / Ersatzteile |                             |   |  |
|--|------------------------|---|---|------|-----|----|------|---|---|-----------------------------|---|--|
|  | R                      | L | DCON  | H    | LF  | WF | DMIN |   | Sıkma Vidası<br>Screw<br>Klemmschraube      | Altlık<br>Shim<br>Unterlage | Altlık Vidası<br>Shim Screw<br>Schraube für Unterlage | Tork Anahtar<br>Torx Key<br>Torx Innensechskantschlüssel |
| <b>S12K SVJCR/L 11</b>                             | ●                      | ● | 12  | 11   | 125 | 7  | ≥13  | <b>VC.T 1103..</b>                        | 4008-M2.5x6                                 | -                           | -   | 82-T08   |
| <b>S16P SVJCR/L 11</b>                             | ●                      | ● | 16  | 14.8 | 170 | 11 | ≥20  |   |   |                             |   |  |
| <b>S20R SVJCR/L 11</b>                             | ●                      | ● | 20  | 18.3 | 200 | 13 | ≥25  |   |   |                             |   |  |
| <b>A12H SVJCR/L 11</b>                             | ●                      | ● | 12  | 11   | 100 | 07 | ≥13  |   |   |                             |   |  |
| <b>A16M SVJCR/L 11</b>                             | ●                      | ● | 16  | 14.8 | 150 | 11 | ≥20  |   |   |                             |   |  |
| <b>A20P SVJCR/L 11</b>                             | ●                      | ● | 20  | 18.3 | 170 | 13 | ≥25  |   |   |                             |   |  |

R: Sağ / Right / Rechts L: Sol / Left / Links  
● Stokta / In Stock / Auf Lager ○ Stokta Yok / Non Stock Item / Kein Lagerartikel, Lieferzeit auf Anfrage

Sipariş Örneği/Ordering Example/Bestellbeispiel  
1 ad./pcs./stück S16P SVXBR 1102

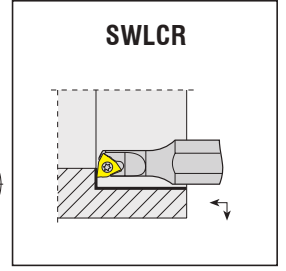
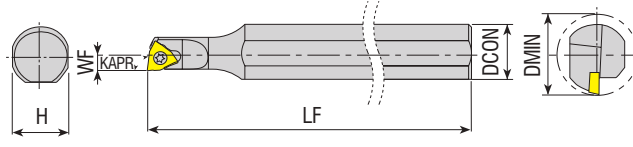

| Takım Kodu<br>Ordering Code<br>Bestell-Bezeichnung | Stok<br>Stock<br>Lager | Takım Ölçüleri (mm)<br>Dimension (mm)<br>Abmessung (mm) |     |     |    |      |  | Kesici Uç<br>Insert<br>Wendeschneidplatte | Yedek Parçaları / Spare Parts / Ersatzteile |  |  |   |        |
|--|------------------------|---|-----|-----|----|------|--|---|---|--|--|---|--------|
|  |                        | DCON  | H   | LF  | WF | DMIN | Sıkma Vidası<br>Screw<br>Klemmschraube |   | Altık Shim<br>Unterlage                     | Altık Vidası<br>Shim Screw<br>Schraube für Unterlage | Tork Anahtar<br>Torx Key<br>Torx Innensechskantschlüssel |   |        |
| S0608H SWLCR/L 03                                  | ●                      | 08  | 7.3 | 100 | 04 | ≥08  | WC.. 0302..                            |   | 4008-M2.5x4                                 |  | -  | - | 82-T08 |
| S0810K SWLCR/L 03                                  | ●                      | 10  | 09  | 125 | 06 | ≥10  |  |   |   |  |  |   |        |

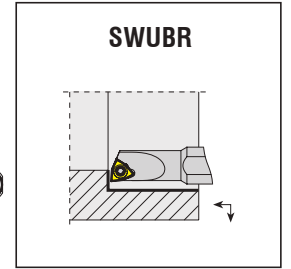
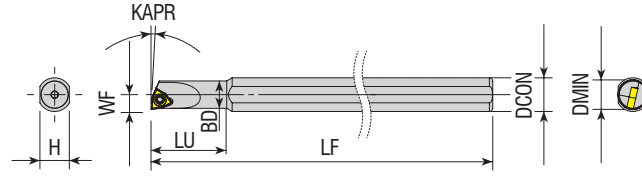

| Takım Kodu<br>Ordering Code<br>Bestell-Bezeichnung | Stok<br>Stock<br>Lager | Takım Ölçüleri (mm)<br>Dimension (mm)<br>Abmessung (mm) |     |     |    |     |      |      |  | Kesici Uç<br>Insert<br>Wendeschneidplatte | Yedek Parçaları / Spare Parts / Ersatzteile |  |  |   |        |
|--|------------------------|---|-----|-----|----|-----|------|------|--|---|---|--|--|---|--------|
|  |                        | DCON  | BD  | H   | LU | LF  | DMIN | WF   | Sıkma Vidası<br>Screw<br>Klemmschraube |   | Altık Shim<br>Unterlage                     | Altık Vidası<br>Shim Screw<br>Schraube für Unterlage | Tork Anahtar<br>Torx Key<br>Torx Innensechskantschlüssel |   |        |
| S0610H SWUBR 06                                    | ●                      | 10  | 5   | 7.3 | 18 | 100 | ≥6   | 3    | WBGT 060102-L                          |   | 3006-M2x3.3                                 |  | -  | - | 82-T06 |
| S08H SWUBR 06-5.5                                  | ●                      | 08  | 5   | 7.3 | 18 | 100 | ≥5.7 | 2.75 |  |   |   |  |  |   |        |
| new S08H SWUBL 06-5.5                              | ●                      | 08  | 5   | 7.3 | 18 | 100 | ≥5.7 | 2.75 |  |   |   |  |  |   |        |
| S08H SWUBR 06-7                                    | ●                      | 08  | 6.5 | 7.3 | 18 | 100 | ≥7   | 3.5  |  |   |   |  |  |   |        |

R: Sağ / Right / Rechts L: Sol / Left / Links

● Stokta / In Stock / Auf Lager ○ Stokta Yok / Non Stock Item / Kein Lagerartikel, Lieferzeit auf Anfrage

KYCR-ISCR Ucuna Uygunudur. / Compatible with KYCR-ISCR Insert. / Kompatibel mit KYCR-ISCR Wendeplatten.

Sipariş Örneği/Ordering Example/Bestellbeispiel

1 ad./pcs./stück S0608H SWLCR 03

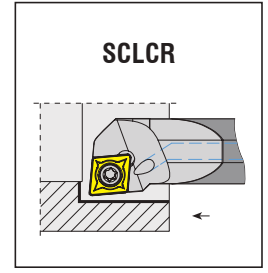
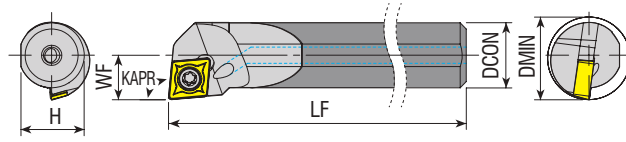

**Takım Kodu**  
**Ordering Code**  
*Bestell-Bezeichnung*

| Stok<br>Stock<br>Lager | Takım Ölçüleri (mm)<br>Dimension (mm)<br>Abmessung (mm) |   |      |     |     |     | Kesici Uç<br>Insert<br>Wendeschneidplatte | Yedek Parçaları / Spare Parts / Ersatzteile |  |                             |   |  |
|------------------------|---|---|------|-----|-----|-----|---|---|--|-----------------------------|---|--|
|                        | R   | L | DCON | H   | LF  | WF  |   | DMIN  | Sıkma Vidası<br>Screw<br>Klemmschraube | Altlık<br>Shim<br>Unterlage | Altlık Vidası<br>Shim Screw<br>Schraube für Unterlage | Tork Anahtar<br>Torx Key<br>Torx Innensechskantschlüssel |
| ● ○                    |   |   | 4    | 3.7 | 90  | 2.5 | ≥5  | CC. 0301..                                  | 4006-M1.6x3.2                          |                             |   | 82-T06   |
| ● ○                    |   |   | 5    | 4.7 | 100 | 3   | ≥6  |   |  |                             |   |  |
| ● ○                    |   |   | 6    | 5.7 | 110 | 3.5 | ≥7  | CC. 0401..                                  | 3006-M2x3.3                            |                             |   | 82-T08   |
| ● ○                    |   |   | 7    | 6.7 | 125 | 4   | ≥8  |   |  |                             |   |  |
| ● ○                    |   |   | 6    | 5.7 | 110 | 4.5 | ≥8  | CC.T 0602..                                 | 4008-M2.5x4.5                          | -                           | -   | 82-T08   |
| ● ●                    |   |   | 8    | 7.5 | 125 | 6   | ≥11                                       |   |  |                             |   |  |
| ● ●                    |   |   | 10   | 9.5 | 150 | 7   | ≥13                                       | CC.T 0602..                                 | 4008-M2.5x6                            |                             |   | 82-T08   |
| ● ●                    |   |   | 12   | 11  | 180 | 9   | ≥16                                       |   |  |                             |   |  |
| ● ●                    |   |   | 16   | 15  | 200 | 11  | ≥20                                       | CC.T 09T3..                                 | 4015-M3.5x9                            |                             |   | 80-T15   |
| ● ●                    |   |   | 20   | 19  | 250 | 13  | ≥24                                       |   |  |                             |   |  |

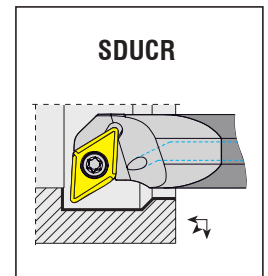
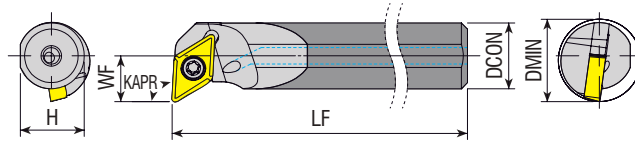

**Takım Kodu**  
**Ordering Code**  
*Bestell-Bezeichnung*





| Stok<br>Stock<br>Lager | Takım Ölçüleri (mm)<br>Dimension (mm)<br>Abmessung (mm) |   |      |      |     |    | Kesici Uç<br>Insert<br>Wendeschneidplatte | Yedek Parçaları / Spare Parts / Ersatzteile |  |                             |   |  |
|------------------------|---|---|------|------|-----|----|---|---|--|-----------------------------|---|--|
|                        | R   | L | DCON | H    | LF  | WF |   | DMIN  | Sıkma Vidası<br>Screw<br>Klemmschraube | Altlık<br>Shim<br>Unterlage | Altlık Vidası<br>Shim Screw<br>Schraube für Unterlage | Tork Anahtar<br>Torx Key<br>Torx Innensechskantschlüssel |
| ● ●                    |   |   | 10   | 9.5  | 150 | 8  | ≥13                                       | DC.T 0702..                                 | 4008-M2.5x6                            | -                           | -   | 82-T08   |
| ● ●                    |   |   | 12   | 11   | 180 | 9  | ≥16                                       |   |  |                             |   |  |
| ● ●                    |   |   | 16   | 15   | 200 | 11 | ≥20                                       | DC.T 11T3..                                 | 4015-M3.5x9                            | -                           | -   | 80-T15   |
| ● ●                    |   |   | 20   | 18.3 | 250 | 12 | ≥23                                       |   |  |                             |   |  |

R: Sağ / Right / Rechts L: Sol / Left / Links

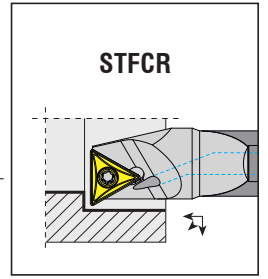
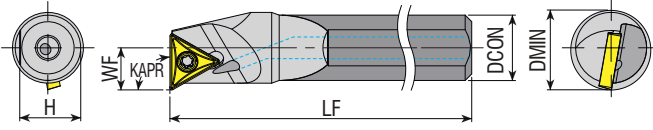

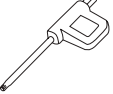

● Stokta / In Stock / Auf Lager ○ Stokta Yok / Non Stock Item / Kein Lagerartikel, Lieferzeit auf Anfrage

Sipariş Örneği/Ordering Example/Bestellbeispiel  
1 ad./pcs./stück C04G SCLCR 03

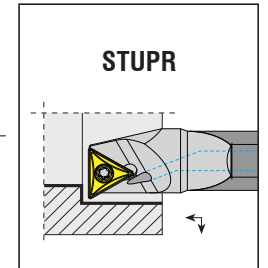
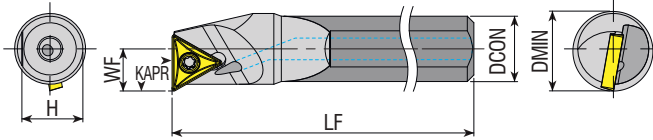

| Takım Kodu<br>Ordering Code<br>Bestell-Bezeichnung | Stok<br>Stock<br>Lager |   | Takım Ölçüleri (mm)<br>Dimension (mm)<br>Abmessung (mm) |     |     |    | Kesici Uç<br>Insert<br>Wendeschneidplatte | Yedek Parçaları / Spare Parts / Ersatzteile                                       |  |   |   |   |   |   |        |
|--|------------------------|---|---|-----|-----|----|---|---|--|---|---|---|---|---|--------|
|  | R                      | L | DCON  | H   | LF  | WF |   | DMIN  | Sıkma Vidası<br>Screw<br>Klemmschraube   | Altık<br>Shim<br>Unterlage  | Altık Vidası<br>Shim Screw<br>Schraube für Unterlage                                | Tork Anahtar<br>Torx Key<br>Torx Innensechskantschlüssel                            |   |   |        |
| E10M STFCR/L 09                                    | ●                      | ● | 10  | 9.5 | 150 | 6  | 12  |  |  |  |  |  |   |   |        |
| E12Q STFCR/L 09                                    | ●                      | ● | 12  | 11  | 180 | 8  | 15  |   |  |   |   |   | - | - | 82-T07 |
| E12Q STFCR/L 11                                    | ●                      | ● | 12  | 11  | 180 | 8  | 15  |   |  |   |   |   |   |   |        |



| Takım Kodu<br>Ordering Code<br>Bestell-Bezeichnung | Stok<br>Stock<br>Lager |   | Takım Ölçüleri (mm)<br>Dimension (mm)<br>Abmessung (mm) |    |     |    | Kesici Uç<br>Insert<br>Wendeschneidplatte | Yedek Parçaları / Spare Parts / Ersatzteile   |  |   |   |   |
|--|------------------------|---|---|----|-----|----|---|---|--|---|---|---|
|  | R                      | L | DCON  | H  | LF  | WF |   | DMIN  | Sıkma Vidası<br>Screw<br>Klemmschraube   | Altık<br>Shim<br>Unterlage  | Altık Vidası<br>Shim Screw<br>Schraube für Unterlage                                  | Tork Anahtar<br>Torx Key<br>Torx Innensechskantschlüssel                              |
| E12Q STUPR/L 1103                                  | ●                      | ○ | 12  | 11 | 180 | 8  | 15  |  |  |  |  |  |
| E16R STUPR/L 1103                                  | ●                      | ○ | 16  | 15 | 200 | 11 | 20  |   |  |   |   |   |

R: Sağ / Right / Rechts L: Sol / Left / Links

● Stokta / In Stock / Auf Lager ○ Stokta Yok / Non Stock Item / Kein Lagerartikel, Lieferzeit auf Anfrage

Sipariş Örneği/Ordering Example/Bestellbeispiel

1 ad./pcs./stück E10M STFCR 09

SET-A/SCLCR/L

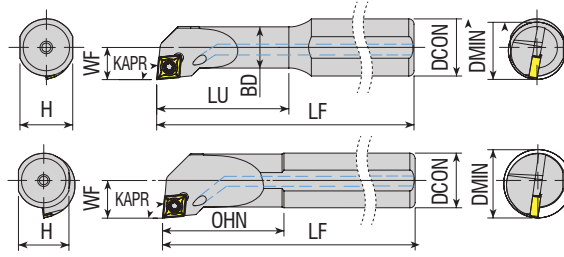

SCLCR

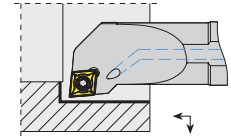

Takım Kodu  
Ordering Code  
Bestell-Bezeichnung

A08H SCLCR/L 06  
A10H SCLCR/L 06  
A12H SCLCR/L 06  
A16M SCLCR/L 09

| Stok<br>Stock<br>Lager | Takım Ölçüleri (mm)<br>Dimension (mm)<br>Abmessung (mm) |    |      |      |    |        |    |     |             | Kesici Uç<br>Insert<br>Wendeschneidplatte | Yedek Parçaları / Spare Parts / Ersatzteile |                             |   |  |
|------------------------|---|----|------|------|----|--------|----|-----|-------------|---|---|-----------------------------|---|--|
|                        | R   | L  | DCON | BD   | H  | LU=OHN | LF | WF  | DMIN        |   | Sıkma Vidası<br>Screw<br>Klemmschraube      | Altlık<br>Shim<br>Unterlage | Altlık Vidası<br>Shim Screw<br>Schraube für Unterlage | Tork Anahtar<br>Torx Key<br>Torx Innensechskantschlüssel |
| ●●                     |   | 8  | 8    | 7.3  | 20 | 100    | 6  | ≥11 | CC.T 0602.. | 4008-M2.5x6                               | -   | -                           | 82-T08  |  |
| ●●                     |   | 10 | 10   | 9    | 25 | 100    | 7  | ≥13 |             |   |   |                             |   |  |
| ●●                     |   | 12 | 12   | 11   | 25 | 100    | 9  | ≥16 |             |   |   |                             |   |  |
| ●●                     |   | 16 | 16   | 14.8 | 35 | 150    | 11 | ≥20 |             |   |   |                             |   | CC.T 09T3..  |

SET-E/SCLCR/L

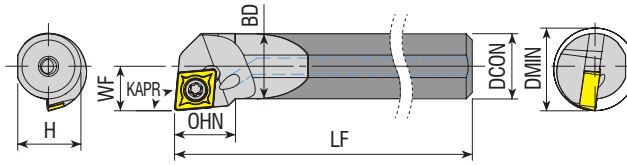

SCLCR

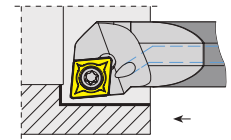

Takım Kodu  
Ordering Code  
Bestell-Bezeichnung

E08K SCLCR/L 06  
E10M SCLCR/L 06  
E12Q SCLCR/L 06  
E16R SCLCR/L 09

| Stok<br>Stock<br>Lager | Takım Ölçüleri (mm)<br>Dimension (mm)<br>Abmessung (mm) |    |      |     |    |     |    |     |             | Kesici Uç<br>Insert<br>Wendeschneidplatte | Yedek Parçaları / Spare Parts / Ersatzteile |                             |   |  |
|------------------------|---|----|------|-----|----|-----|----|-----|-------------|---|---|-----------------------------|---|--|
|                        | R   | L  | DCON | BD  | H  | OHN | LF | WF  | DMIN        |   | Sıkma Vidası<br>Screw<br>Klemmschraube      | Altlık<br>Shim<br>Unterlage | Altlık Vidası<br>Shim Screw<br>Schraube für Unterlage | Tork Anahtar<br>Torx Key<br>Torx Innensechskantschlüssel |
| ●○                     |   | 8  | 8    | 7.5 | 10 | 125 | 6  | ≥11 | CC.T 0602.. | 4008-M2.5x6                               | -   | -                           | 82-T08  |  |
| ●○                     |   | 10 | 10   | 9.5 | 10 | 150 | 7  | ≥13 |             |   |   |                             |   |  |
| ●○                     |   | 12 | 12   | 11  | 12 | 180 | 9  | ≥16 |             |   |   |                             |   |  |
| ●○                     |   | 16 | 16   | 15  | 15 | 200 | 11 | ≥20 |             |   |   |                             |   | CC.T 09T3..  |

SET-S/SCLCR/L

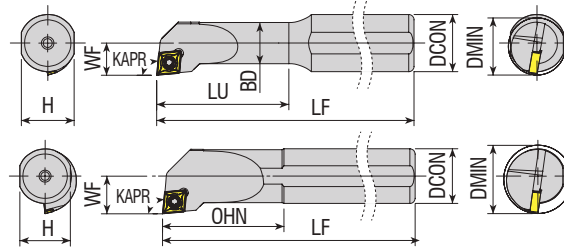

SCLCR

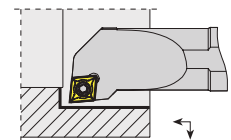

Takım Kodu  
Ordering Code  
Bestell-Bezeichnung

S08H SCLCR/L 06  
S10K SCLCR/L 06  
S12K SCLCR/L 06  
S16P SCLCR/L 09

| Stok<br>Stock<br>Lager | Takım Ölçüleri (mm)<br>Dimension (mm)<br>Abmessung (mm) |    |      |      |    |        |    |     |             | Kesici Uç<br>Insert<br>Wendeschneidplatte | Yedek Parçaları / Spare Parts / Ersatzteile |                             |   |  |
|------------------------|---|----|------|------|----|--------|----|-----|-------------|---|---|-----------------------------|---|--|
|                        | R   | L  | DCON | BD   | H  | LU=OHN | LF | WF  | DMIN        |   | Sıkma Vidası<br>Screw<br>Klemmschraube      | Altlık<br>Shim<br>Unterlage | Altlık Vidası<br>Shim Screw<br>Schraube für Unterlage | Tork Anahtar<br>Torx Key<br>Torx Innensechskantschlüssel |
| ●●                     |   | 8  | 8    | 7.3  | 20 | 100    | 6  | ≥11 | CC.T 0602.. | 4008-M2.5x6                               | -   | -                           | 82-T08  |  |
| ●●                     |   | 10 | 10   | 9    | 25 | 125    | 7  | ≥13 |             |   |   |                             |   |  |
| ●●                     |   | 12 | 12   | 11   | 25 | 125    | 9  | ≥16 |             |   |   |                             |   |  |
| ●●                     |   | 16 | 16   | 14.8 | 35 | 170    | 11 | ≥20 |             |   |   |                             |   | CC.T 09T3..  |

R: Sağ / Right / Rechts L: Sol / Left / Links

● Stokta / In Stock / Auf Lager ○ Stokta Yok / Non Stock Item / Kein Lagerartikel, Lieferzeit auf Anfrage

Sipariş Örneği/Ordering Example/Bestellbeispiel

1 ad./pcs./stück SET-A/SCLCR

SET-A/SDUCR/L

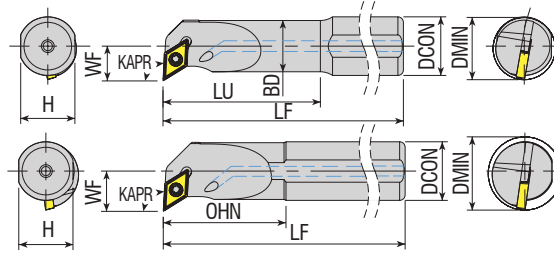

SDUCR

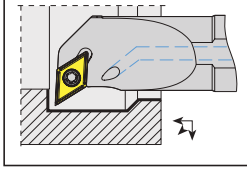

**Takım Kodu**  
**Ordering Code**  
*Bestell-Bezeichnung*

Stok  
Stock  
Lager

Takım Ölçüleri (mm)  
Dimension (mm)  
Abmessung (mm)

Kesici Uç  
Insert  
Wendeschneidplatte

Sıkma Vidası  
Screw  
Klemmschraube

Yedek Parçaları / Spare Parts / Ersatzteile

Altlık  
Shim  
Unterlage

Altlık Vidası  
Shim Screw  
Schraube für Unterlage

Tork Anahtar  
Torx Key  
Torx-Innensechskantschlüssel

R L DCON BD H LU=OHN LF WF DMIN



**A10H SDUCR/L 07**  
**A12H SDUCR/L 07**  
**A16M SDUCR/L 11**

● ● 10 10 09 25 100 08 ≥13  
● ● 12 12 11 25 100 09 ≥16  
● ● 16 16 14.8 35 150 11 ≥20

**DC.T 0702..**  
**DC.T 11T3..**

4008-M2.5x6  
4015-M3.5x9

-  
-

-  
-

82-T08  
80-T15

SET-E/SDUCR/L

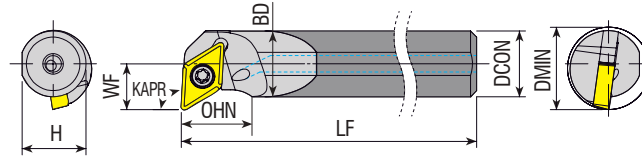

SDUCR

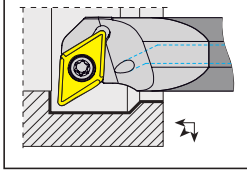

**Takım Kodu**  
**Ordering Code**  
*Bestell-Bezeichnung*

Stok  
Stock  
Lager

Takım Ölçüleri (mm)  
Dimension (mm)  
Abmessung (mm)

Kesici Uç  
Insert  
Wendeschneidplatte

Sıkma Vidası  
Screw  
Klemmschraube

Yedek Parçaları / Spare Parts / Ersatzteile

Altlık  
Shim  
Unterlage

Altlık Vidası  
Shim Screw  
Schraube für Unterlage

Tork Anahtar  
Torx Key  
Torx-Innensechskantschlüssel

R L DCON BD H OHN LF WF DMIN

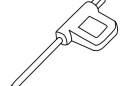

**E10M SDUCR/L 07**  
**E12Q SDUCR/L 07**  
**E16R SDUCR/L 11**

● ○ 10 10 9.5 09 150 8 ≥13  
● ○ 12 12 11 10 180 9 ≥16  
● ○ 16 16 15 12 200 11 ≥20

**DC.T 0702..**  
**DC.T 11T3..**

4008-M2.5x6  
4015-M3.5x9

-  
-

-  
-

82-T08  
80-T15

SET-S/SDUCR/L

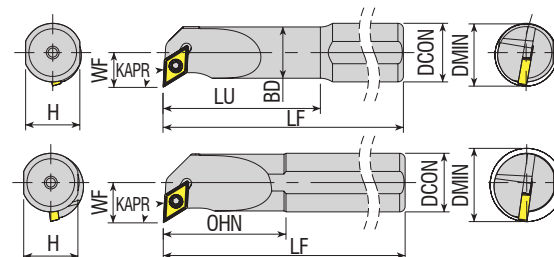

SDUCR

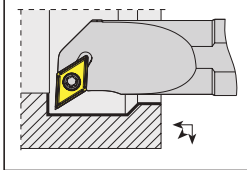

**Takım Kodu**  
**Ordering Code**  
*Bestell-Bezeichnung*

Stok  
Stock  
Lager

Takım Ölçüleri (mm)  
Dimension (mm)  
Abmessung (mm)

Kesici Uç  
Insert  
Wendeschneidplatte

Sıkma Vidası  
Screw  
Klemmschraube

Yedek Parçaları / Spare Parts / Ersatzteile

Altlık  
Shim  
Unterlage

Altlık Vidası  
Shim Screw  
Schraube für Unterlage

Tork Anahtar  
Torx Key  
Torx-Innensechskantschlüssel

R L DCON BD H LU=OHN LF WF DMIN

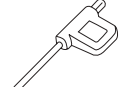

**S10K SDUCR/L 07**  
**S12K SDUCR/L 07**  
**S16P SDUCR/L 11**

● ● 10 10 9 25 125 8 ≥13  
● ● 12 12 11 25 125 9 ≥16  
● ● 16 16 14.8 35 170 11 ≥20

**DC.T 0702..**  
**DC.T 11T3..**

4008-M2.5x6  
4015-M3.5x9

-  
-

-  
-

82-T08  
80-T15





*konusulan*  
*the spoken kalite...*  
*quality...*

# TIRLAMAZ

**TIRLAMAZ TAKIMLAR**  
**ANTIVIBRATION TOOLS**  
**SCHWINGUNGSGEDÄMPFTE BOHRSTANGEN**

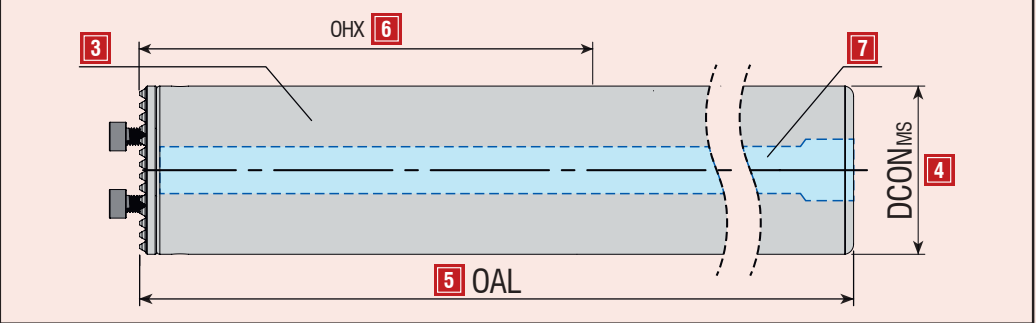

**AKKO** **A** **TT** **B** **D16** **204** **10D** **H** **E**

|  |  |   |  |  |   |
|--|--|---|--|--|---|
| <b>2</b> Takım Tipi<br>Tool Type<br>Werkzeugtyp                          | <b>3</b> Gövde<br>Body<br>Schaft   | <b>4</b> Bağlantı Çapı<br>Connection Diameter<br>Anschlussdurchmesser | <b>5</b> Takım Boyu<br>Overall length<br>Gesamtlänge | <b>6</b> Bağlama Boyu<br>Overhang maximum<br>Maximale Auskrugung | <b>7</b> İçten Soğutmalı<br>With Coolant Hole<br>Mit Innenkühlung |
| Tırlamaz Takım<br>Anti Vibration Tool<br>Schwingungsgedämpfte Bohrstanqe |  |   |  |  |   |
| <b>8</b> Takım Malzemesi<br>Type of Boring Bar<br>Art der Bohrstanqe     | Karbür Takviyeli<br>Carbide reinforced<br>Hartmetall verstärkt                     |   |  |  |   |

**AKKO** **A** **TT** **C** **A** **16** **SDUCR11**

|  |   |   |  |
|--|---|---|--|
| <b>2</b> Takım Tipi<br>Tool Type<br>Werkzeugtyp  | <b>3</b> Kartuş Kodu<br>Cartridge Code<br>Bezeichnung für Wechselkopf | <b>4</b> İçten Soğutmalı<br>With Coolant Hole<br>Mit Innenkühlung | <b>5</b> Bağlama Çapı<br>Connection Diameter<br>Anschlussdurchmesser |
| Tırlamaz Takım Kartuşu<br>Anti Vibration Tool Cartridge<br>Wechselkopf für Schwingungsgedämpfte Bohrstanqe | Kartuş<br>Cartridge<br>Wechselkopf                                    |   | Ø16 - Ø20 - Ø25<br>Ø32 - Ø40   |
| <b>2</b> Kartuş Tipi<br>Cartridge Type<br>Wechselkopftyp   | SDUCR/L, SCLCR/L, SVUCR/L, TCLNR/L, TDUNR/L                           |   |  |
|                       |   |   |  |

**AKKO** **A** **TT** **C** **16-25**

|   |  |  |
|---|--|--|
| <b>2</b> Takım Tipi<br>Tool Type<br>Werkzeugtyp   | <b>3</b> Kartuş<br>Cartridge<br>Wechselkopf  | <b>4</b> Kullanılan Gövde Çap Aralığı<br>Usable diameter range for body<br>Nutzbarer Durchmesserbereich für Werkzeugschaft |
| Tırlamaz Takım Kartuşu<br>Anti Vibration Tool Cartridge<br>Wechselkopf für Schwingungsgedämpfte Bohrstanqen | Merkezeleme Kartuş Kodu<br>Centering Cartridge Code<br>Bezeichnung für zentriertes Wechselkopf | ATTB-D16/D20/D25<br>ATTB-D32/D40/D50/D60   |
|                         |  |  |

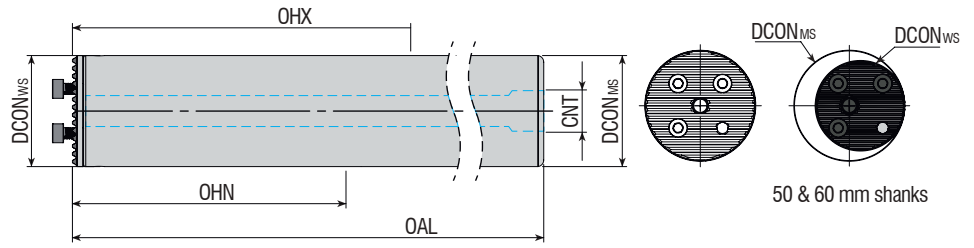
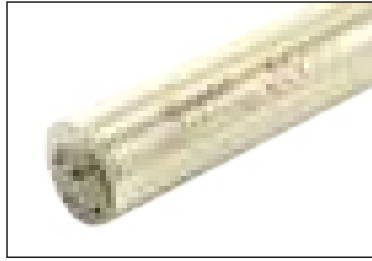

| Takım Kodu<br>Ordering Code<br>Bestell-Bezeichnung | Stok<br>Stock<br>Lager | Takım Ölçüleri (mm)<br>Dimension (mm)<br>Abmessung (mm) |        |     |     |     |      |   | Yedek Parçaları / Spare Parts / Ersatzteile |   |            |
|--|------------------------|---|--------|-----|-----|-----|------|---|---|---|------------|
|  |                        | DCONMS  | DCONWS | OAL | OHN | OHX | CNT  | Montaj Vidası<br>Shim Screw<br>Schraube für Unterlage |   | Montaj Vida Anahtar<br>Mounting Screw Key<br>Монтажный винт столовой под шестигранник |            |
|  |                        |   |        |     |     |     |      | DCON  | DMIN  |   |            |
| ATTB-D16-156-7D-H                                  | ○                      | 16  | 16     | 156 | 55  | 92  | G1/8 | 16  | 20  | 2525-M3X10  | AAL-02-2.5 |
| ATTB-D16-204-10D-H-E                               | ○                      | 16  | 16     | 204 | 96  | 140 | G1/8 | 16  | 20  |   |            |
| ATTB-D20-200-7D-H                                  | ○                      | 20  | 20     | 200 | 70  | 120 | G1/4 | 20  | 25  |   |            |
| ATTB-D20-260-10D-H-E                               | ○                      | 20  | 20     | 260 | 120 | 180 | G1/4 | 20  | 25  | 2525-M3.5X10  | AAL-03-3   |
| ATTB-D25-255-7D-H                                  | ●                      | 25  | 25     | 255 | 88  | 158 | G1/4 | 25  | 32  |   |            |
| ATTB-D25-330-10D-H                                 | ○                      | 25  | 25     | 330 | 155 | 230 | G1/4 | 25  | 32  | 2503-M4X12  | AAL-05-4   |
| ATTB-D32-320-7D-H                                  | ●                      | 32  | 32     | 320 | 100 | 192 | G3/8 | 32  | 40  |   |            |
| ATTB-D32-416-10D-H                                 | ○                      | 32  | 32     | 416 | 192 | 288 | G3/8 | 32  | 40  | 2504-M5X16  | AAL-07-5   |
| ATTB-D40-408-7D-H                                  | ●                      | 40  | 40     | 408 | 128 | 248 | G1/2 | 40  | 50  |   |            |
| ATTB-D40-528-10D-H                                 | ○                      | 40  | 40     | 528 | 248 | 368 | G1/2 | 40  | 50  | 2505-M6X16  | AAL-07-5   |
| ATTB-D50-519-7D-H                                  | ●                      | 50  | 40     | 519 | 168 | 318 | G1/2 | 40  | 63  |   |            |
| ATTB-D50-669-10D-H                                 | ○                      | 50  | 40     | 669 | 318 | 468 | G1/2 | 40  | 63  | 2505-M6X16  | AAL-07-5   |
| ATTB-D60-628-7D-H                                  | ●                      | 60  | 40     | 628 | 208 | 388 | G3/4 | 40  | 80  |   |            |
| ATTB-D60-808-10D-H                                 | ○                      | 60  | 40     | 808 | 388 | 568 | G3/4 | 40  | 80  |   |            |

R: Sağ / Right / Rechts L: Sol / Left / Links

● Stokta / In Stock / Auf Lager ○ Stokta Yok / Non Stock Item / Kein Lagerartikel, Lieferzeit auf Anfrage

Sipariş Örneği/Ordering Example/Bestellbeispiel

1 ad./pcs./stück ATTB-D16-156-7D-H



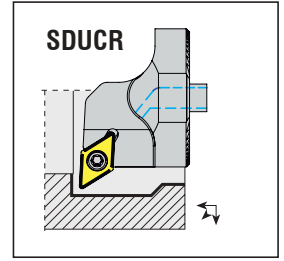
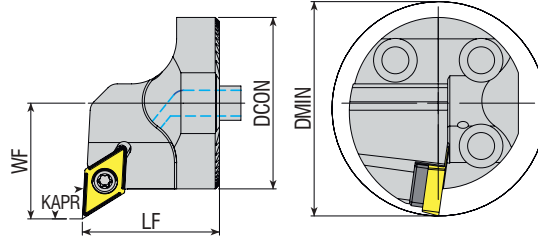

| Takım Kodu<br>Ordering Code<br>Bestell-Bezeichnung | Stok<br>Stock<br>Lager |   | Takım Ölçüleri (mm)<br>Dimension (mm)<br>Abmessung (mm) |    |    |      | Kesici Uç<br>Insert<br>Wendeschneidplatte | Yedek Parçaları / Spare Parts / Ersatzteile |                             |   |  |
|--|------------------------|---|---|----|----|------|---|---|-----------------------------|---|--|
|  | R                      | L | DCON  | LF | WF | DMIN |   | Sıkma Vidası<br>Screw<br>Klemmschraube      | Altlık<br>Shim<br>Unterlage | Altlık Vidası<br>Shim Screw<br>Schraube für Unterlage | Tork Anahtar<br>Torx Key<br>Torx Innensechskantschlüssel |
| ATTC-A16 SDUCR/L 07                                | ●                      | ● | 16  | 20 | 11 | 20   | DC.T 0702..                               | 4008-M2.5x6                                 | -                           | -   | 82-T08   |
| ATTC-A20 SDUCR/L 11                                | ●                      | ● | 20  | 20 | 13 | 25   |   | 4015-M3.5x11                                | -                           | -   |  |
| ATTC-A25 SDUCR/L 11                                | ●                      | ● | 25  | 23 | 17 | 32   | DC.T 11T3..                               | 4015-M3.5x12                                | -                           | AAV-08-M3.5x8   | 80-T15   |
| ATTC-A32 SDUCR/L 11                                | ●                      | ● | 32  | 32 | 22 | 40   |   | 4015-M3.5x14                                | AADN-2-0001                 | AAV-06-M3.5x11  |  |
| ATTC-A40 SDUCR/L 11                                | ●                      | ● | 40  | 32 | 27 | 50   |   |   |                             |   |  |

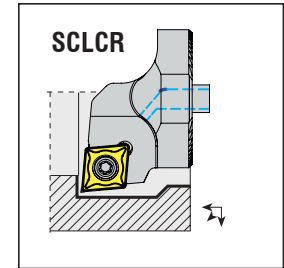
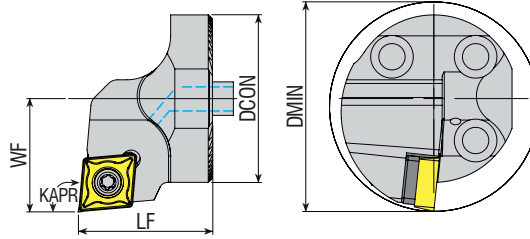

| Takım Kodu<br>Ordering Code<br>Bestell-Bezeichnung | Stok<br>Stock<br>Lager |   | Takım Ölçüleri (mm)<br>Dimension (mm)<br>Abmessung (mm) |    |    |      | Kesici Uç<br>Insert<br>Wendeschneidplatte | Yedek Parçaları / Spare Parts / Ersatzteile |                             |   |  |
|--|------------------------|---|---|----|----|------|---|---|-----------------------------|---|--|
|  | R                      | L | DCON  | LF | WF | DMIN |   | Sıkma Vidası<br>Screw<br>Klemmschraube      | Altlık<br>Shim<br>Unterlage | Altlık Vidası<br>Shim Screw<br>Schraube für Unterlage | Tork Anahtar<br>Torx Key<br>Torx Innensechskantschlüssel |
| ATTC-A16 SCLCR/L 06                                | ●                      | ● | 16  | 20 | 11 | 20   | CC.T 0602..                               | 4008-M2.5x6                                 | -                           | -   | 82-T08   |
| ATTC-A20 SCLCR/L 09                                | ●                      | ● | 20  | 20 | 13 | 25   |   | 4015-M3.5x9                                 | -                           | -   |  |
| ATTC-A25 SCLCR/L 09                                | ●                      | ● | 25  | 23 | 17 | 32   | CC.T 09T3..                               | 4015-M3.5x12                                | AACN-2-0001                 | AAV-08-M3.5x8   | 80-T15   |
| ATTC-A32 SCLCR/L 09                                | ●                      | ● | 32  | 32 | 22 | 40   |   |   |                             |   |  |
| ATTC-A40 SCLCR/L 12                                | ●                      | ● | 40  | 32 | 27 | 50   | CC.T 1204..                               | 1020-M4.5x16                                | AACN-2-0003                 | AAV-07-M4.5x13  | 80-T20   |

R: Sağ / Right / Rechts L: Sol / Left / Links  
● Stokta / In Stock / Auf Lager ○ Stokta Yok / Non Stock Item / Kein Lagerartikel, Lieferzeit auf Anfrage

Sipariş Örneği/Ordering Example/Bestellbeispiel  
1 ad./pcs./stück ATTC-A16-SDUCR 07

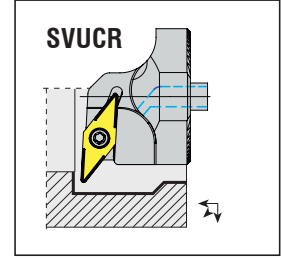
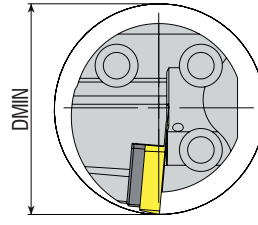
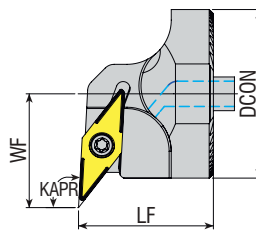

**Takım Kodu**  
**Ordering Code**  
**Bestell-Bezeichnung**

| Stok<br>Stock<br>Lager | TAKIM ÖLÇÜLERİ (MM)<br>DIMENSION (MM)<br>ABMESSUNG (MM) |   |      |    |    | Kesici Uç<br>Insert<br>Wendeschneidplatte | Yedek Parçaları / Spare Parts / Ersatzteile |  |                             |   |   |
|------------------------|---|---|------|----|----|---|---|--|-----------------------------|---|---|
|                        | R   | L | DCON | LF | WF |   | DMIN  | Sıkma Vidası<br>Screw<br>Klemmschraube | Altlık<br>Shim<br>Unterlage | Altlık Vidası<br>Shim Screw<br>Schraube für Unterlage | Tork Anahtar<br>Torx Key<br>Innensechskantschlüssel |
| ATTC-A20 SVUCR/L 11    | ●   | ● | 20   | 20 | 15 | 27  |   |  | -                           | -   |   |
| ATTC-A25 SVUCR/L 11    | ●   | ● | 25   | 23 | 17 | 32  | <b>VC.T 1103..</b>                          | 4008-M2.5x6                            | -                           | -   | 82-T08  |
| ATTC-A32 SVUCR/L 16    | ●   | ● | 32   | 32 | 22 | 40  | <b>VC.T 1604..</b>                          | 4015-M3.5x14                           | AAVN-2-0002                 | AAV-06-M3.5x11  | 80-T15  |
| ATTC-A40 SVUCR/L 16    | ●   | ● | 40   | 32 | 27 | 50  |   |  |                             |   |   |

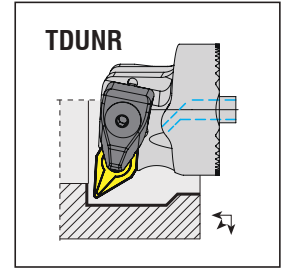
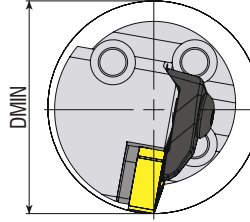
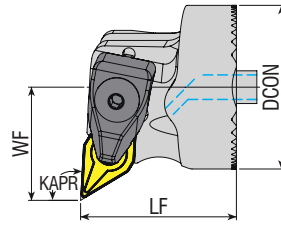

**Takım Kodu**  
**Ordering Code**  
**Bestell-Bezeichnung**

| Stok<br>Stock<br>Lager | Takım Ölçüleri (mm)<br>Dimension (mm)<br>Abmessung (mm) |   |      |    |    | Kesici Uç<br>Insert<br>Wendeschneidplatte | Yedek Parçaları / Spare Parts / Ersatzteile |  |  |                             |   |                         |                      |   |
|------------------------|---|---|------|----|----|---|---|--|--|-----------------------------|---|-------------------------|----------------------|---|
|                        | R   | L | DCON | LF | WF |   | DMIN  | Baskı Pabuçu<br>Wedge Clamp<br>Spannpratze | Pabuç Vidası<br>Clamp Screw<br>Klemmschraube | Altlık<br>Shim<br>Unterlage | Altlık Vidası<br>Shim Screw<br>Schraube für Unterlage | Segman<br>Ring<br>Feder | Pul<br>Stamp<br>Ring | Anahtar<br>Allen Key<br>Innensechskantschlüssel |
| ATTC-A32 TDUNR/L 11    | ●   | ● | 32   | 32 | 22 | 40  |   |  |  |                             |   |                         |                      |   |
| ATTC-A40 TDUNR/L 15    | ●   | ● | 40   | 38 | 27 | 50  | <b>DNM. 1104..</b>                          | ATK-01                                     | AKV-01-M5x22                                 | AADN -2-0001                | AAV-04-M5x12  | AS-01                   | ABPL-01              | AAL-03-3  |
|                        |   |   |      |    |    |   | <b>DNM. 1506..</b>                          | ATK-02                                     | AKV-30-M6x22                                 | AADN -3-0001                | AAV-02-M5x12  |                         |                      |   |

R: Sağ / Right / Rechts L: Sol / Left / Links

● Stokta / In Stock / Auf Lager ○ Stokta Yok / Non Stock Item / Kein Lagerartikel, Lieferzeit auf Anfrage

Sipariş Örneği/Ordering Example/Bestellbeispiel

1 AD./PCS./STÜCK ATTC-A20 SVUCR 11

**TIRLAMAZ TAKIMLARIN KARTUŞLARI**  
**ANTI VIBRATION TOOLS CARTRIDGES**  
 WECHSELKOPF FÜR SCHWINGUNGSGEDÄMPFTE BORSTANGE

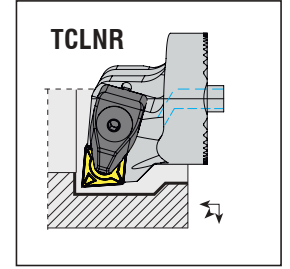
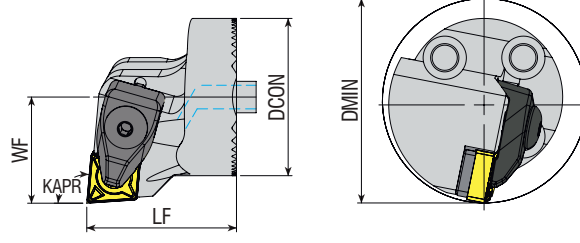

| Takım Kodu<br>Ordering Code<br>Bestell-Bezeichnung | Stok<br>Stock<br>Lager |   | Takım Ölçüleri (mm)<br>Dimension (mm)<br>Abmessung (mm) |    |    |      | Kesici Uç<br>Insert<br>Wendeschneidplatte | Baskı Pabucu<br>Wedge Clamp<br>Spannpratze | Pabuç Vidası<br>Clamp Screw<br>Klemmschraube | Altlık<br>Shim<br>Unterlage | Altlık Vidası<br>Shim Screw<br>Schraube für Unterlage | Segman<br>Ring<br>Feder | Pul<br>Stamp<br>Ring | Anahtar<br>Allen Key<br>Innensechskantschlüssel |
|--|------------------------|---|---|----|----|------|---|--|--|-----------------------------|---|-------------------------|----------------------|---|
|  | R                      | L | DCON  | LF | WF | DMIN |   |  |  |                             |   |                         |                      |   |
| ATTC-A32 TCLNR/L 12                                | ●                      | ● | 32  | 32 | 22 | 40   |   |  |  |                             |   |                         |                      |   |
| ATTC-A40 TCLNR/L 12                                | ●                      | ● | 40  | 38 | 27 | 50   | <b>CNM. 1204..</b>                        | ATK-02                                     | AKV-30-M6x22                                 | AACN -3-0001                | AAV-02-M5x12  | AS-01                   | ABPL-01              | AAL-03-3  |

**TIRLAMAZ TAKIMLARIN MERKEZLEME APARATI**  
**ANTI VIBRATION TOOLS CENTERING INSTRUMENT**  
 ZENTRIERWERKZEUG FÜR SCHWINGUNGSGEDÄMPFTE BORSTANGE

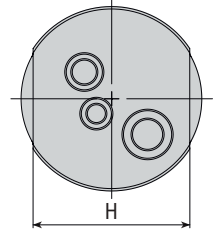
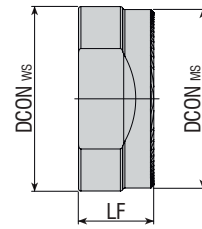
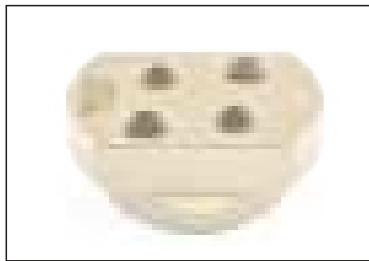

| Takım Kodu<br>Ordering Code<br>Bestell-Bezeichnung | Stok<br>Stock<br>Lager | Takım Ölçüleri (mm)<br>Dimension (mm)<br>Abmessung (mm) |        |    |    | Gövde Tipi<br>Booring Bars<br>Борштанги |
|--|------------------------|---|--------|----|----|---|
|  |                        | DCONWS  | DCONMS | LF | H  |   |
| ATTC-16-25   | ●                      | 28  | 25     | 15 | 22 | ATTB-D16/D20/D25                        |
| ATTC-32-60   | ●                      | 53  | 40     | 20 | 35 | ATTB-D32/D40/D50/D60                    |

R: Sağ / Right / Rechts L: Sol / Left / Links  
 ● Stokta / In Stock / Auf Lager ○ Stokta Yok / Non Stock Item / Kein Lagerartikel, Lieferzeit auf Anfrage

Sipariş Örneği/Ordering Example/Bestellbeispiel  
 1 ad./pcs./stück ATTC-A32 TCLNR 12

## 1 Montaj ve Ayarlama | Assembly and Adjusting | Montage und Einstellung

Kartuş ve gövdenin montaj edilecek yüzeyleri, tutucunun iç kısmı temizlenmelidir. Aşağıdaki görselde A ve B konumlarına bakın.

The surface of the cartridge and the shank to be mounted, as well as the inner part of the toolholder should be cleaned. Check A and B in the image below.

Die Oberflächen des Wechselkopfes und des zu montierenden Schafts sowie der innere Teil des Werkzeughalters sollten gereinigt werden. Siehe A und B unten auf der Abbildung

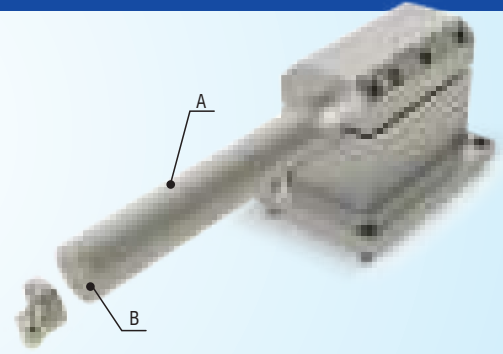

## 2 Gövde Montajı | Assembly for the Shank | Schaftmontage

Bağlama uzunluğu 4 L / D oranından az olmamalıdır. Tutucunun üst kısmını çıkartma yöntemiyle veya diğer tutma sıkma yöntemleriyle kullanmanızı öneririz (C tipi). Vidalı bağlama yöntemi kullanmayın. Uzun süre çalışırken lütfen içten soğutmayı kullanın.

The clamping length should not be less than 4 L/D ratio. Suggest using the clamping cover with opening method and other holding clamping methods. (Type C). Do not use screw clamping method. Use inner cooling please when working a long time.

Die Einspannlänge sollte nicht weniger als 4 L / D ratio betragen. Vorgeschlagen ist die Oberseite des Halters zu öffnen und andere Halte-Klemmethoden zu verwenden. (Typ C). Bitte nicht die Schraubklemmethode verwenden. Bei langer Nutzung, bitte die Innenkühlung verwenden.

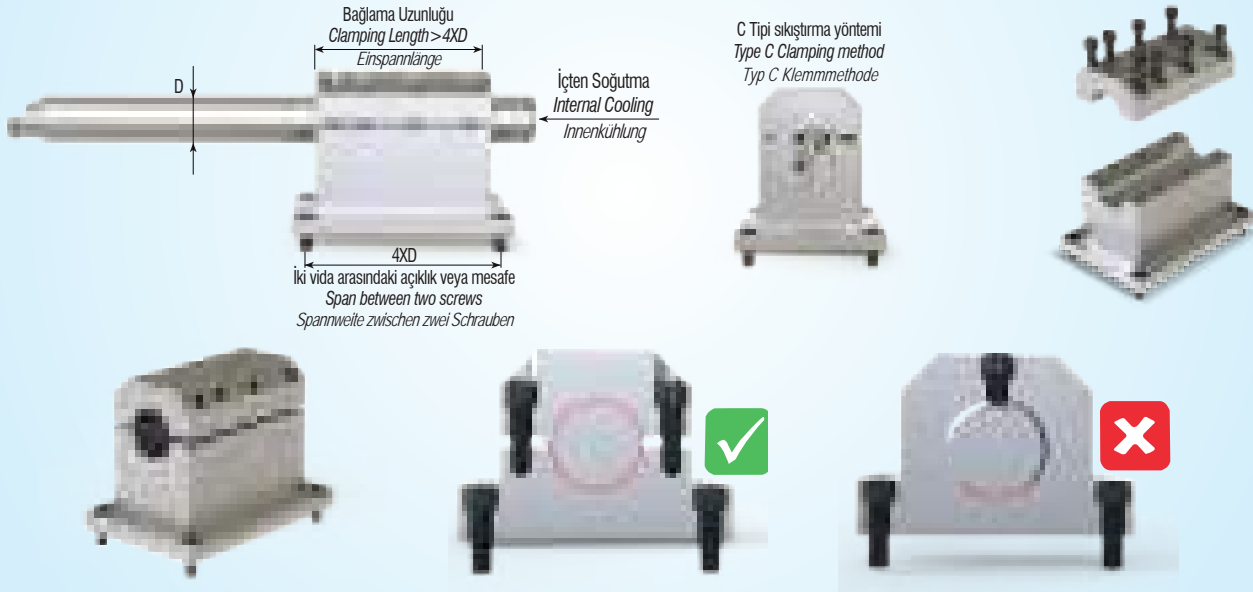

## 3 Merkez Yüksekliğinin Ayarlanması | Adjusting the Height of Centre Assembly | Einstellung der Zentrumhöhe

Gövdeyi ilk kez montaj ederken merkez yüksekliği için özel kalibrasyon aparatı kullanılmalıdır. Önce gövdeyi tutucuya monte edin, ardından X ekseninde 0,01 tolerans içinde kalibre edin. Lütfen komparatör saati ile ayarlamayı yapın.

When mounting the body for the first time, a special calibration tool should be used for the center height. First mount the shank on the holder, then calibrate it within 0.01 tolerance on the X axis direction. Please make the adjustment with the dial indicator device.

Bei der erstmaligen Montage des Schaftes sollte ein spezielles Kalibrierwerkzeug für die Zentrumhöhe verwendet werden. Montieren Sie zuerst den Schaft am Halter und kalibrieren Sie es dann innerhalb einer Toleranz von 0,01 in Richtung der X-Achse. Bitte benutzen Sie bei der Einstellung eine Messuhr

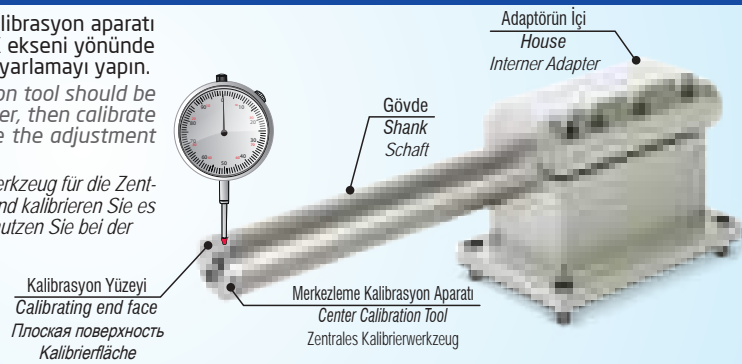

## 4 Doğru Kartuş Montajı | Assembly the Right Cartridge | Richtige Wechselkopfmontage

Yandaki şekle bakın:

See the figure on the side:

Siehe die Abbildung auf der Seite:

Sol Yön Takım  
Left Hand  
Linke Richtung



Sağ Yön Takım  
Right Hand  
Rechte Richtung

**Doğru Uç Seçimi / Choosing the Correct Insert / Auswahl der richtigen Wendeschneidplatte**

Doğru kesici ucun seçilmesi, titreşim sönümlenmenin genel başarısı üzerinde büyük bir etkiye sahiptir. Kesici ucun işleme stabilitesini artırabilmesinin ana yolu kesme kuvvetlerini en aza indirmektir. Titreşimleri ortadan kaldırmak için aşağıdaki adımlara uymanız gerekir: Mümkünse, her zaman kısa takımları kullanın. Aksi takdirde, titreşimi en aza indirmek için hızlarınızı azaltın.

*Choosing the correct insert can have a big influence on the overall success of vibration damping. The main way the insert can improve the machining stability is by minimizing the cutting forces. Following the guidelines below should be your first step to eliminate vibrations: If possible, use it always short drilling tools. Otherwise, reduce your speeds to minimize vibration.*

*Die Auswahl des richtigen Einsatzes kann einen großen Einfluss auf den Gesamterfolg der Schwingungsdämpfung haben. Die Wendeschneidplatte kann die Bearbeitungsstabilität hauptsächlich durch Minimierung der Schneidkräfte verbessern. Das Befolgen der folgenden Richtlinien sollte Ihr erster Schritt sein, um Vibrationen zu beseitigen: Verwenden Sie nach Möglichkeit immer kurze Werkzeuge. Reduzieren Sie andernfalls die Geschwindigkeit, um Vibrationen zu minimieren.*

**A** Radyal kuvvetleri minimuma indirmek için mümkün olduğunca 90° 'ye yakın bir giriş açılı takımı seçin.

*Choose an entry angle that is as close as possible to 90° to reduce the radial forces to a minimum.*

*Wählen Sie einen Eintrittswinkel, der so nah wie möglich an 90° liegt, um die Radialkräfte auf ein Minimum zu reduzieren.*

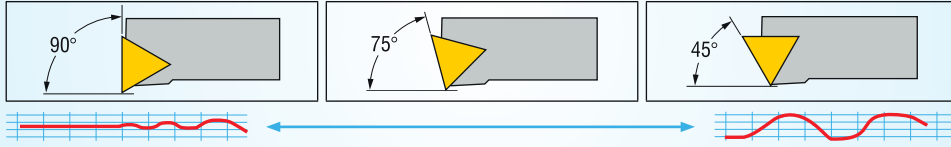

**B** Mümkün olan en küçük kesici uç açısını seçin. Böylece kesme kuvvetleri azalacak ve yüzey kalitesi artacak.

*Choose the smallest insert head angle possible. This will reduce overall cutting forces and increase the clearance.*

*Wählen Sie den kleinstmöglichen Wendeschneidplattenwinkel. Damit wird sich die Gesamtschneidkraft verringern und die Klarheit verbessern.*

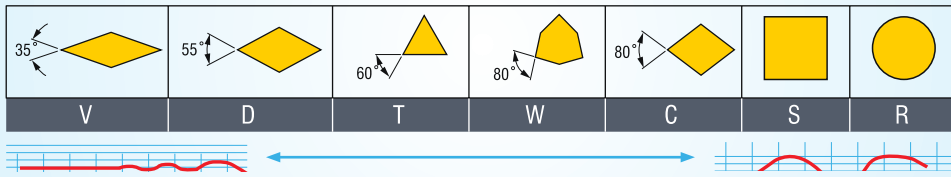

**C** Titreşimi azaltmak için olabildiğince en küçük radyüslü ucu seçmelisiniz.

*Choose a small nose radius to reduce the cutting forces and to enable machining in a lower depth of cut.*

*Wählen Sie einen Eintrittswinkel, der so nah wie möglich an 90° liegt, um die Radialkräfte auf ein Minimum zu reduzieren.*

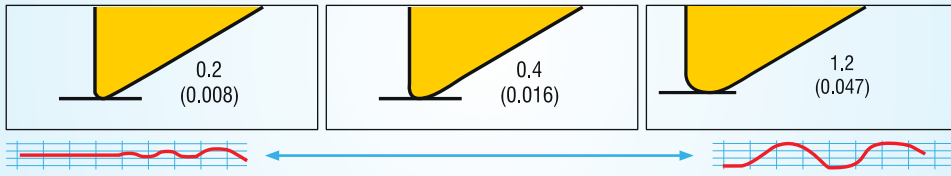

**D** İşleme derinliği (ap) radyüsten daha büyük olmalıdır.

*Machining depth (ap) should be larger than the nose radius.*

*Die Bearbeitungstiefe (ap) sollte größer als der Schneideckenradius sein.*

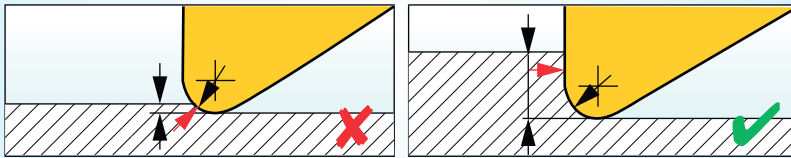

**E** Kesme kuvvetlerini azaltmak için daha pozitif geometriye sahip bir kesici uç kullanın:

*Use an insert with an overall positive geometry to reduce the cutting forces:*

*Verwenden Sie eine Wendeschneidplatte mit insgesamt positiver Geometrie, um die Schneidkräfte zu reduzieren:*

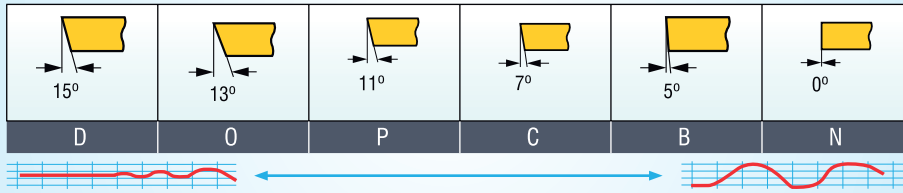

**F** Pozitif bir üst eğim geometrisi seçin:

*Choose a positive top rake geometry:*

*Benutzen Sie einen positiven, oberen Spanwinkel:*

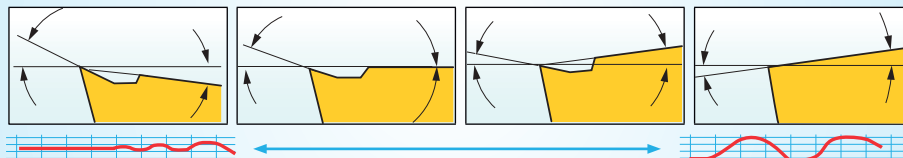

**G** For-dampened-straight-adaptor:



*L, kesildikten sonra min uzunluk*  
*L, min length after cut off*  
*L, min Länge nach dem Abschneiden*

| Ø  | Kısa Tasarım<br>Short Design<br>Kurzes Design<br>4-7x Ø (mm) | Uzun Tasarım<br>Long Design<br>Langes Design<br>7-10x Ø (mm) |
|----|--|--|
| 16 | 100  | 155  |
| 20 | 125  | 200  |
| 25 | 155  | 255  |
| 32 | 190  | 320  |
| 40 | 240  | 410  |
| 50 | 305  | 520  |
| 60 | 380  | 630  |





*konusulan  
the spoken kalite...  
quality...*

# KARTUŞLAR

KARTUŞLAR  
CARTRIDGE  
KURZDREHHALTER



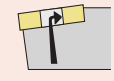
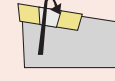

**S T F C R 12 C A 16**

**1** Sıkma Tipi / Method of Mounting of Insert / Klemmsystem

|   |   |   |
|---|---|---|
|  |  |  |
| Deliksiz Üstten Sıkma<br>Top Clamping Without Hole<br>Pratzenklemmsystem          | Delikten Levye ile Sıkma<br>Hole Clamping (Lever Lock)<br>Kniehebel-Spannsystem   | Vida ile Sıkma<br>Screw on<br>Schrauben-Spannsystem                               |
| <b>C</b>  | <b>P</b>  | <b>S</b>  |



**2** Uç Tipi / Type of Insert / Plattenform

|   |   |   |
|---|---|---|
|  |  |  |
| <b>C</b>  | <b>S</b>  | <b>T</b>  |

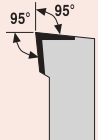
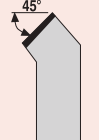
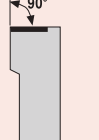
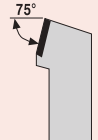
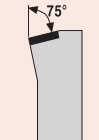
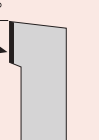
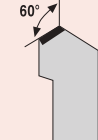
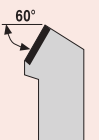
**3** Yanaşma Açısı / Tool Holder Shape Bar Geometry / Anstellwinkel

|   |   |   |
|---|---|---|
|  |  |  |
| <b>L</b>  | <b>S</b>  | <b>F</b>  |
|  |  |  |
| <b>R</b>  | <b>K</b>  | <b>G</b>  |
|  |  |   |
| <b>W</b>  | <b>T</b>  |   |

**4** Serbest Uç Açısı / Insert Clearance Angle / Freiwinkel

|   |   |   |
|---|---|---|
|  |  |  |
| <b>C</b>  | <b>P</b>  | <b>N</b>  |

**5** Kesme Yönü / Cutting Direction / Halterausführung

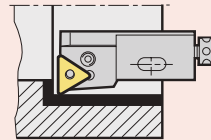
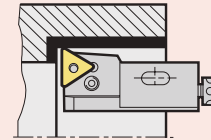
|  |   |
|--|---|
|  |  |
| <b>R</b>   | <b>L</b>  |

**6** Kesme Kenar Yüksekliği / Cutting Edge Height / Drehhalterhöhe

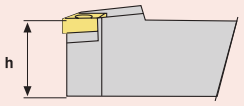



**7** Kartuş Kodu / Cartridge Code / Wechselkopfbezeichnung

**C**  
(Kartuş / Cartridge Code / Kurzdrehhalter Bezeichnung)

**8** Kartuş Tipi / Cartridge Type / Wechselkopftyp

**A**  
(ISO 5611)

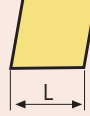
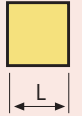
**9** Kesme Kenar Uzunluğu / Cutting Edge Length / Halterausführung

|  |   |   |
|--|---|---|
|  |  |  |
| <b>L</b>   | <b>L</b>  | <b>L</b>  |

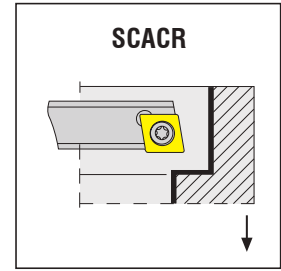
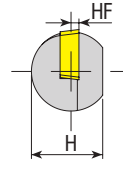
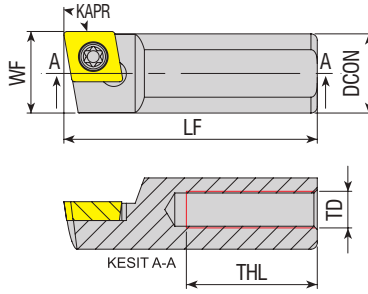

Takım Kodu  
Ordering Code  
Bestell-Bezeichnung

Stok  
Stock  
Lager

Takım Ölçüleri (mm)  
Dimension (mm)  
Abmessung (mm)

Kesici Uç  
Insert  
Wendeschneidplatte

Yedek Parçaları / Spare Parts / Ersatzteile

Sıkma Vidası  
Screw  
Klemmschraube

Tork Anahtar  
Torx Key  
Torx Innensechskantschlüssel

R L

DCON

H

LF

THL

HF

WF

TD



| Takım Kodu<br>Ordering Code<br>Bestell-Bezeichnung | R | L | DCON | H    | LF  | THL | HF | WF   | TD      |
|--|---|---|------|------|-----|-----|----|------|---------|
| S10X SCACR/L 06                                    | ● | ● | 10   | 9    | 25  | 10  | 1  | 10.3 | M5x0.8  |
| S10A SCACR/L 06                                    | ● | ● | 10   | 9    | 32  | 15  | 1  | 10.3 | M5x0.8  |
| S1018 SCACR/L 06                                   | ○ | ● | 10   | 9    | 18  | 8   | 1  | 9.8  | M5x0.8  |
| S1065 SCACR/L 06                                   | ○ | ● | 10   | 9    | 65  | 25  | 1  | 10.3 | M5x0.8  |
| S10C SCACR/L 06                                    | ● | ● | 10   | 9    | 50  | 25  | 1  | 10.3 | M5x0.8  |
| S12B SCACR/L 06                                    | ● | ● | 12   | 11   | 40  | 25  | 1  | 12.3 | M5x0.8  |
| S12D SCACR/L 06                                    | ● | ● | 12   | 11   | 60  | 25  | 1  | 12.3 | M5x0.8  |
| S12D SCACR/L 09                                    | ● | ● | 12   | 11   | 60  | 25  | 2  | 12.2 | M5x0.8  |
| S1265 SCACR/L 09                                   | ○ | ● | 12   | 11   | 65  | 25  | 2  | 12.3 | M5x0.8  |
| S12H SCACR/L 09                                    | ● | ● | 12   | 11   | 100 | 25  | 2  | 12.2 | M5x0.8  |
| S15C SCACR/L 09                                    | ● | ● | 15   | 14   | 50  | 25  | 2  | 15.3 | M8x1.25 |
| S1554 SCACR/L 09                                   | ○ | ● | 15   | 14   | 54  | 25  | 2  | 15.3 | M8x1.25 |
| S15E SCACR/L 09                                    | ○ | ● | 15   | 14   | 70  | 45  | 2  | 15.3 | M8x1.25 |
| S15D SCACR/L 09                                    | ○ | ● | 15   | 14   | 60  | 30  | 2  | 15.3 | M8x1.25 |
| S16A SCACR/L 09                                    | ● | ● | 16   | 15   | 32  | 15  | 2  | 16.5 | M6x1    |
| S16B SCACR/L 09                                    | ● | ● | 16   | 15   | 40  | 20  | 2  | 16.5 | M6x1    |
| S16C SCACR/L 09                                    | ○ | ● | 16   | 15   | 50  | 25  | 2  | 16.5 | M6x1    |
| S16D SCACR/L 09                                    | ● | ● | 16   | 15   | 60  | 30  | 2  | 16.5 | M6x1    |
| S16E SCACR/L 09                                    | ○ | ● | 16   | 15   | 70  | 30  | 2  | 16.5 | M6x1    |
| S16G SCACR/L 09                                    | ● | ● | 16   | 15   | 90  | 30  | 2  | 16.5 | M6x1    |
| S16H SCACR/L 09                                    | ○ | ● | 16   | 15   | 100 | 35  | 4  | 16.5 | M6x1    |
| S1868 SCACR/L 09                                   | ○ | ● | 18   | 17   | 68  | 30  | 2  | 18.5 | M8x1.25 |
| S18E SCACR/L 09                                    | ● | ● | 18   | 17   | 70  | 30  | 2  | 18.5 | M8x1.25 |
| S1888 SCACR/L 09                                   | ○ | ● | 18   | 17   | 88  | 30  | 2  | 18.5 | M8x1.25 |
| S18105 SCACR/L 09                                  | ○ | ● | 18   | 17   | 105 | 30  | 2  | 18.5 | M8x1.25 |
| S18175 SCACR/L 09                                  | ○ | ● | 18   | 17   | 175 | 30  | 2  | 18.5 | M8x1.25 |
| S20E SCACR/L 09                                    | ● | ● | 20   | 18.3 | 70  | 30  | 2  | 20.5 | M6x1    |
| S20E SCACR/L 12                                    | ● | ● | 20   | 18.3 | 70  | 30  | 2  | 20.5 | M6x1    |
| S20H SCACR/L 12                                    | ● | ● | 20   | 18.3 | 100 | 30  | 2  | 20.5 | M6x1    |

CC.T 0602..

4008-M2.5x6

82-T08

CC.T 09T3..

4015-M3.5x8

80-T15

CC.T 1204..

1020-M5x11

80-T20

R: Sağ / Right / Rechts L: Sol / Left / Links

● Stokta / In Stock / Auf Lager ○ Stokta Yok / Non Stock Item / Kein Lagerartikel, Lieferzeit auf Anfrage

Sipariş Örneği/Ordering Example/Bestellbeispiel

1 ad./pcs./stück S10X SCACR 06

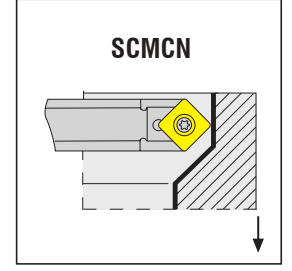
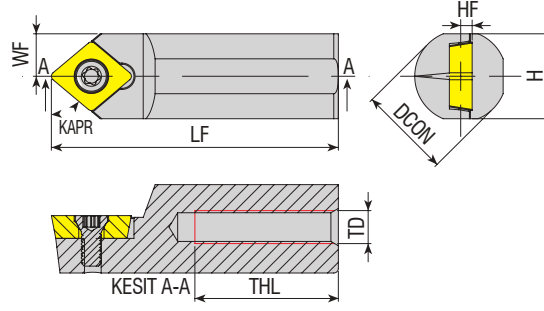

| Takım Kodu<br>Ordering Code<br>Bestell-Bezeichnung | Stok<br>Stock<br>Lager | Takım Ölçüleri (mm)<br>Dimension (mm)<br>Abmessung (mm) |    |    |     |    |    |        | Kesici Uç<br>Insert<br>Wendeschneidplatte | Yedek Parçaları / Spare Parts / Ersatzteile |  |  |
|--|------------------------|---|----|----|-----|----|----|--------|---|---|--|--|
|  |                        | DCON  | H  | LF | THL | HF | WF | TD     |   | Sıkma Vidası<br>Screw<br>Klemmschraube      | Tork Anahtar<br>Torx Key<br>Torx Innensechskantschlüssel |  |
| S10X SCMCN 06                                      | ●                      | 10  | 9  | 25 | 10  | 1  | 5  | M5x0.8 |   | 4008-M2.5x6                                 | 82-T08   |  |
| <b>new</b> S10A SCMCN 06                           | ●                      | 10  | 9  | 32 | 15  | 1  | 5  |        |   |   |  |  |
| <b>new</b> S10B SCMCN 06                           | ●                      | 10  | 9  | 40 | 20  | 1  | 5  |        |   |   |  |  |
| <b>new</b> S10C SCMCN 06                           | ●                      | 10  | 9  | 50 | 25  | 1  | 5  |        |   |   |  |  |
| <b>new</b> S10D SCMCN 06                           | ●                      | 10  | 9  | 60 | 25  | 1  | 5  |        |   |   |  |  |
| S12D SCMCN 06                                      | ●                      | 12  | 11 | 60 | 25  | 1  | 6  | M6x1   | CC.T 09T3..                               | 4015-M3.5x11                                | 80-T15   |  |
| S16C SCMCN 09                                      | ●                      | 16  | 15 | 50 | 25  | 2  | 8  |        |   |   |  |  |
| S16D SCMCN 09                                      | ●                      | 16  | 15 | 60 | 25  | 4  | 8  |        |   |   |  |  |

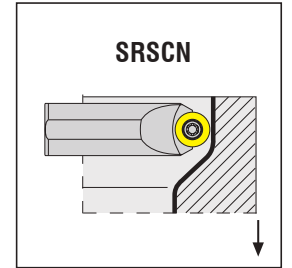
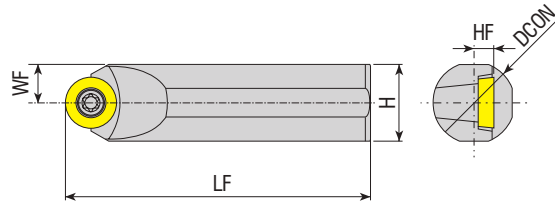

| Takım Kodu<br>Ordering Code<br>Bestell-Bezeichnung | Stok<br>Stock<br>Lager | Takım Ölçüleri (mm)<br>Dimension (mm)<br>Abmessung (mm) |    |    |     |    | Kesici Uç<br>Insert<br>Wendeschneidplatte | Yedek Parçaları / Spare Parts / Ersatzteile |  |  |
|--|------------------------|---|----|----|-----|----|---|---|--|--|
|  |                        | DCON  | H  | WF | HF  | LF |   | Sıkma Vidası<br>Screw<br>Klemmschraube      | Tork Anahtar<br>Torx Key<br>Torx Innensechskantschlüssel |  |
| S12D SRSCN 10                                      | ●                      | 12  | 11 | 6  | 3.9 | 60 | RC.. 10T3..                               | 4015-M3.5x9                                 | 80-T15   |  |
| S14D SRSCN 10                                      | ●                      | 14  | 13 | 7  | 3.9 | 60 |   | 4015-M3.5x11                                |  |  |
| S16D SRSCN 10                                      | ●                      | 16  | 15 | 8  | 3.9 | 60 |   |   |  |  |

R: Sağ / Right / Rechts L: Sol / Left / Links

● Stokta / In Stock / Auf Lager ○ Stokta Yok / Non Stock Item / Kein Lagerartikel, Lieferzeit auf Anfrage

Sipariş Örneği/Ordering Example/Bestellbeispiel

1 ad./pcs./stück S10X SCMCN 06

KAPR=35°

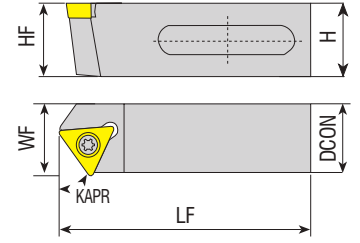

| Takım Kodu<br>Ordering Code<br>Bestell-Bezeichnung | Stok<br>Stock<br>Lager |   | Takım Ölçüleri (mm)<br>Dimension (mm)<br>Abmessung (mm) |    |    |     |    | Kesici Uç<br>Insert<br>Wendeschneidplatte | Yedek Parçaları / Spare Parts / Ersatzteile |  |  |
|--|------------------------|---|---|----|----|-----|----|---|---|--|--|
|  | R                      | L | DCON  | H  | HF | LF  | WF |   | Sıkma Vidası<br>Screw<br>Klemmschraube      | Tork Anahtar<br>Torx Key<br>Torx Innensechskantschlüssel |  |
|  |                        |   |   |    |    |     |    |   |   |  |  |
| STXCR/L 2020 B16                                   | ○                      | ● | 20  | 20 | 20 | 45  | 20 | TC.. 16T3..                               |   |  |  |
| STXCR/L 2020 E16                                   | ○                      | ● | 20  | 20 | 20 | 70  | 20 |   |   |  |  |
| STXCR/L 2020 B16-SA                                | ○                      | ● | 20  | 10 | 20 | 45  | 20 |   |   |  |  |
| STXCR/L 2020 E16-SA                                | ○                      | ● | 20  | 10 | 20 | 70  | 20 |   |   |  |  |
| STXCR/L 2020 B16-PL                                | ○                      | ● | 20  | 10 | 20 | 45  | 20 |   |   |  |  |
| STXCR/L 2020 E16-PL                                | ○                      | ● | 20  | 10 | 20 | 70  | 20 |   |   |  |  |
| STXCR/L 2020 H16-PL                                | ○                      | ● | 20  | 10 | 20 | 100 | 20 |   |   |  |  |

KAPR=90°

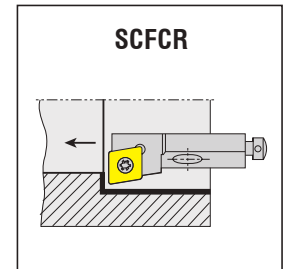
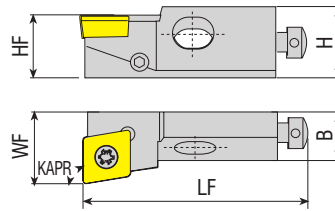
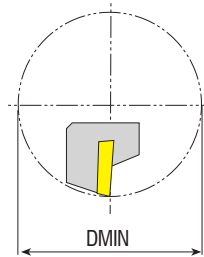

| Takım Kodu<br>Ordering Code<br>Bestell-Bezeichnung | Stok<br>Stock<br>Lager |   | Takım Ölçüleri (mm)<br>Dimension (mm)<br>Abmessung (mm) |     |    |    |    |      | Kesici Uç<br>Insert<br>Wendeschneidplatte | Yedek Parçaları / Spare Parts / Ersatzteile |  |  |  |
|--|------------------------|---|---|-----|----|----|----|------|---|---|--|--|--|
|  | R                      | L | HF  | H   | B  | LF | WF | DMIN |   | Altık<br>Shim<br>Unterlage                  | Altık Vidası<br>Shim Screw<br>Schraube für Unterlage | Sıkma Vidası<br>Screw<br>Klemmschraube | Tork Anahtar<br>Torx Key<br>Torx Innensechskantschlüssel |
|  |                        |   |   |     |    |    |    |      |   |   |  |  |  |
| SCFCR/L 06CA 06                                    | ●                      | ● | 6   | 8.5 | 6  | 25 | 8  | ≥20  | CC.T 060204                               | -   | -  | 4008-M2.5x6                            | 82-T08   |
| SCFCR/L 08CA 06                                    | ●                      | ● | 8   | 11  | 8  | 32 | 10 | ≥25  |   |   |  |  |  |
| SCFCR/L 10CA 09                                    | ●                      | ● | 10  | 15  | 11 | 50 | 14 | ≥40  |   |   |  |  |  |
| SCFCR/L 12CA 12                                    | ●                      | ○ | 12  | 20  | 15 | 55 | 20 | ≥50  |   |   |  |  |  |
| SCFCR/L 16CA 12                                    | ●                      | ● | 16  | 21  | 20 | 63 | 25 | ≥60  | CC.T 120408                               | AACN-2-0003                                 | AAV-10-M4.5x8  | 4020-M4.5x12                           | 80-T20   |

R: Sağ / Right / Rechts L: Sol / Left / Links

● Stokta / In Stock / Auf Lager ○ Stokta Yok / Non Stock Item / Kein Lagerartikel, Lieferzeit auf Anfrage

Sipariş Örneği/Ordering Example/Bestellbeispiel

1 ad./pcs./stück STXCR 2020 B16

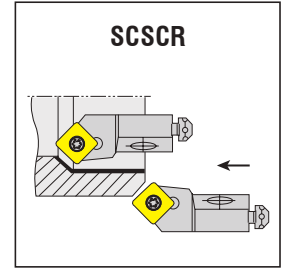
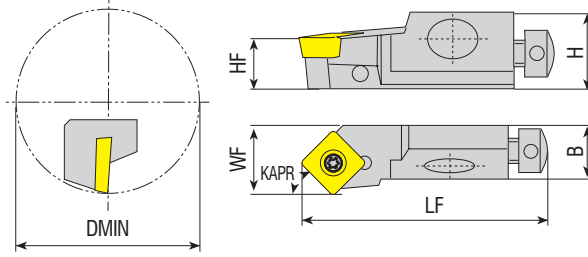

| Takım Kodu<br>Ordering Code<br>Bestell-Bezeichnung | Stok<br>Stock<br>Lager |   | Takım Ölçüleri (mm)<br>Dimension (mm)<br>Abmessung (mm) |    |    |    |    |      | Kesici Uç<br>Insert<br>Wendeschneidplatte | Yedek Parçaları / Spare Parts / Ersatzteile |   |  |  |
|--|------------------------|---|---|----|----|----|----|------|---|---|---|--|--|
|  | R                      | L | HF  | H  | B  | LF | WF | DMIN |   | Altlık<br>Shim<br>Unterlage                 | Altlık Vidası<br>Shim Screw<br>Schraube für Unterlage | Sıkma Vidası<br>Screw<br>Klemmschraube | Tork Anahtar<br>Torx Key<br>Torx Innensechskantschlüssel |
| SCSCR/L 06CA 06                                    | ●                      | ○ | 6   | 8  | 6  | 30 | 8  | ≥20  |   |   |   |  |  |
| SCSCR/L 10CA 09                                    | ●                      | ○ | 10  | 15 | 11 | 50 | 14 | ≥40  |   |   |   |  |  |
| SCSCR/L 12CA 12                                    | ○                      | ○ | 12  | 20 | 15 | 55 | 20 | ≥50  |   |   |   |  |  |

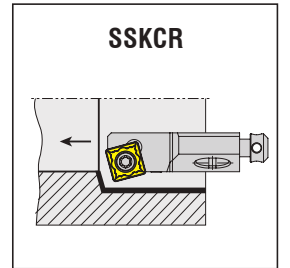
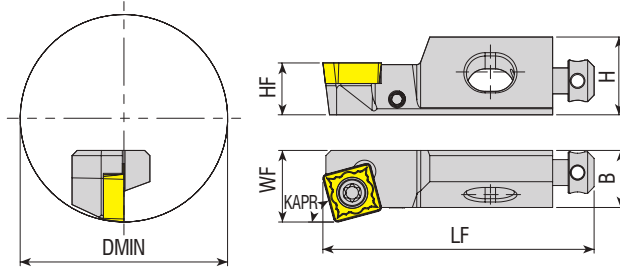

| Takım Kodu<br>Ordering Code<br>Bestell-Bezeichnung | Stok<br>Stock<br>Lager |   | Takım Ölçüleri (mm)<br>Dimension (mm)<br>Abmessung (mm) |    |    |    |    |      | Kesici Uç<br>Insert<br>Wendeschneidplatte | Yedek Parçaları / Spare Parts / Ersatzteile |   |  |  |
|--|------------------------|---|---|----|----|----|----|------|---|---|---|--|--|
|  | R                      | L | HF  | H  | B  | LF | WF | DMIN |   | Altlık<br>Shim<br>Unterlage                 | Altlık Vidası<br>Shim Screw<br>Schraube für Unterlage | Sıkma Vidası<br>Screw<br>Klemmschraube | Tork Anahtar<br>Torx Key<br>Torx Innensechskantschlüssel |
| SSKCR/L 10CA 09                                    | ●                      | ○ | 10  | 15 | 11 | 50 | 14 | ≥40  |   |   |   |  |  |
| SSKCR/L 12CA 12                                    | ●                      | ○ | 12  | 20 | 15 | 55 | 20 | ≥50  |   |   |   |  |  |

R: Sağ / Right / Rechts L: Sol / Left / Links

● Stokta / In Stock / Auf Lager ○ Stokta Yok / Non Stock Item / Kein Lagerartikel, Lieferzeit auf Anfrage

Sipariş Örneği/Ordering Example/Bestellbeispiel

1 ad./pcs./stück SCSCR 06CA 06

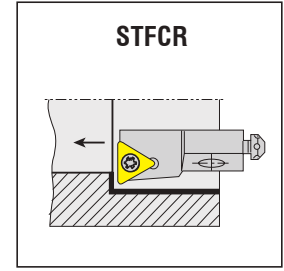
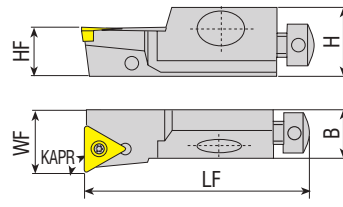
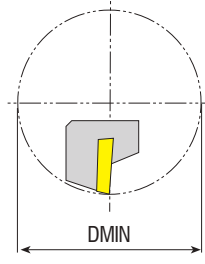

**Takım Kodu**  
**Ordering Code**  
**Bestell-Bezeichnung**

| R | L | HF | H  | B  | LF | WF | DMIN | Kesici Uç<br>Insert<br>Wendeschneidplatte | Yedek Parçaları / Spare Parts / Ersatzteile |  |  |  |
|---|---|----|----|----|----|----|------|---|---|--|--|--|
|   |   |    |    |    |    |    |      |   | Altık<br>Shim<br>Unterlage                  | Altık Vidası<br>Shim Screw<br>Schraube für Unterlage | Sıkma Vidası<br>Screw<br>Klemmschraube | Tork Anahtar<br>Torx Key<br>Torx Innensechskantschlüssel |
| ● | ● | 8  | 11 | 8  | 32 | 10 | ≥25  | TC.T 090204<br>TC.T 110204<br>TC.T 16T308 | -   | -  | 3007-M2.2x4.6                          | 82-T07   |
| ● | ● | 10 | 15 | 11 | 50 | 14 | ≥40  |   | -   | -  | 4008-M2.5x6                            | 82-T08   |
| ● | ○ | 12 | 20 | 15 | 55 | 20 | ≥50  |   | -   | -  | 4015-M3.5x11                           | 80-T15   |
| ● | ● | 16 | 21 | 20 | 63 | 25 | ≥60  |   | AATN-2-0001                                 | AAV-06-M3.5x11                                       | 4015-M3.5x14                           |  |

| R | L | HF | H  | B  | LF | WF | DMIN | Kesici Uç<br>Insert<br>Wendeschneidplatte | Yedek Parçaları / Spare Parts / Ersatzteile |  |  |  |
|---|---|----|----|----|----|----|------|---|---|--|--|--|
|   |   |    |    |    |    |    |      |   | Altık<br>Shim<br>Unterlage                  | Altık Vidası<br>Shim Screw<br>Schraube für Unterlage | Sıkma Vidası<br>Screw<br>Klemmschraube | Tork Anahtar<br>Torx Key<br>Torx Innensechskantschlüssel |
| ● | ● | 8  | 11 | 8  | 32 | 10 | ≥25  | TC.T 090204<br>TC.T 110204<br>TC.T 16T308 | -   | -  | 3007-M2.2x4.6                          | 82-T07   |
| ● | ● | 10 | 15 | 11 | 50 | 14 | ≥40  |   | -   | -  | 4008-M2.5x6                            | 82-T08   |
| ● | ○ | 12 | 20 | 15 | 55 | 20 | ≥50  |   | -   | -  | 4015-M3.5x11                           | 80-T15   |
| ● | ● | 16 | 21 | 20 | 63 | 25 | ≥60  |   | AATN-2-0001                                 | AAV-06-M3.5x11                                       | 4015-M3.5x14                           |  |

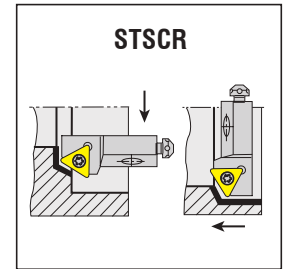
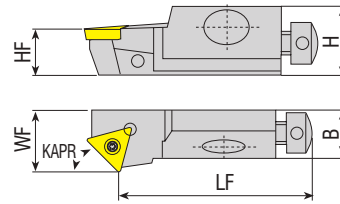
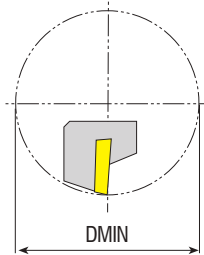

**Takım Kodu**  
**Ordering Code**  
**Bestell-Bezeichnung**

| R | L | HF | H  | B  | LF | WF | DMIN | Kesici Uç<br>Insert<br>Wendeschneidplatte | Yedek Parçaları / Spare Parts / Ersatzteile |  |  |  |
|---|---|----|----|----|----|----|------|---|---|--|--|--|
|   |   |    |    |    |    |    |      |   | Altık<br>Shim<br>Unterlage                  | Altık Vidası<br>Shim Screw<br>Schraube für Unterlage | Sıkma Vidası<br>Screw<br>Klemmschraube | Tork Anahtar<br>Torx Key<br>Torx Innensechskantschlüssel |
| ● | ○ | 8  | 11 | 8  | 28 | 10 | ≥25  | TC.T 090204<br>TC.T 110204<br>TC.T 16T308 | -   | -  | 3007-M2.2x4.6                          | 82-T07   |
| ● | ● | 10 | 15 | 11 | 44 | 14 | ≥40  |   | -   | -  | 4008-M2.5x6                            | 82-T08   |
| ● | ○ | 12 | 20 | 15 | 47 | 20 | ≥50  |   | -   | -  | 4015-M3.5x11                           | 80-T15   |

| R | L | HF | H  | B  | LF | WF | DMIN | Kesici Uç<br>Insert<br>Wendeschneidplatte | Yedek Parçaları / Spare Parts / Ersatzteile |  |  |  |
|---|---|----|----|----|----|----|------|---|---|--|--|--|
|   |   |    |    |    |    |    |      |   | Altık<br>Shim<br>Unterlage                  | Altık Vidası<br>Shim Screw<br>Schraube für Unterlage | Sıkma Vidası<br>Screw<br>Klemmschraube | Tork Anahtar<br>Torx Key<br>Torx Innensechskantschlüssel |
| ● | ○ | 8  | 11 | 8  | 28 | 10 | ≥25  | TC.T 090204<br>TC.T 110204<br>TC.T 16T308 | -   | -  | 3007-M2.2x4.6                          | 82-T07   |
| ● | ● | 10 | 15 | 11 | 44 | 14 | ≥40  |   | -   | -  | 4008-M2.5x6                            | 82-T08   |
| ● | ○ | 12 | 20 | 15 | 47 | 20 | ≥50  |   | -   | -  | 4015-M3.5x11                           | 80-T15   |

R: Sağ / Right / Rechts L: Sol / Left / Links  
● Stokta / In Stock / Auf Lager ○ Stokta Yok / Non Stock Item / Kein Lagerartikel, Lieferzeit auf Anfrage

Sipariş Örneği/Ordering Example/Bestellbeispiel  
1 ad./pcs./stück STFPCR 08CA 09

> S-SİSTEM KARTUŞLAR  
S-SYSTEM CARTRIDGE  
S-SYSTEM KURZDREHHALTER

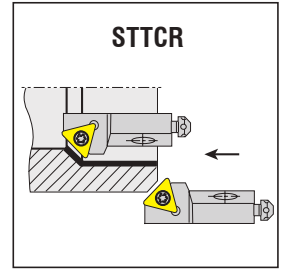
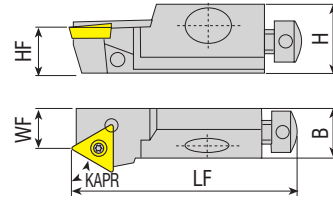
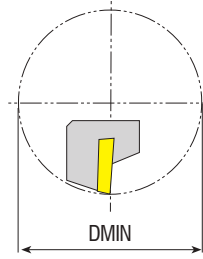

| Takım Kodu<br>Ordering Code<br>Bestell-Bezeichnung | Stok<br>Stock<br>Lager |   | Takım Ölçüleri (mm)<br>Dimension (mm)<br>Abmessung (mm) |    |      |    |    | Kesici Uç<br>Insert<br>Wendeschneidplatte | Yedek Parçaları / Spare Parts / Ersatzteile |                             |   |  |  |
|--|------------------------|---|---|----|------|----|----|---|---|-----------------------------|---|--|--|
|  | R                      | L | HF  | H  | B    | LF | WF |   | DMIN  | Altlık<br>Shim<br>Unterlage | Altlık Vidası<br>Shim Screw<br>Schraube für Unterlage | Sıkma Vidası<br>Screw<br>Klemmschraube | Tork Anahtar<br>Torx Key<br>Torx Innensechskantschlüssel |
| STTCR/L 08CA 09                                    | ●                      | ● | 8   | 11 | 8    | 32 | 6  | ≥25                                       |   | -                           | -   | 3007-M2.2x4.6                          | 82-T07   |
| STTCR/L 10CA 11                                    | ●                      | ● | 10  | 15 | 11   | 50 | 9  | ≥40                                       |   | -                           | -   | 4008-M2.5x6                            | 82-T08   |
| <b>new</b> STTCR/L 12CA 16                         | ●                      | ○ | 12  | 20 | 14.8 | 55 | 20 | ≥50                                       |   | -                           | -   | 4015-M3.5x9                            | 80-T15   |

> P-SİSTEM KARTUŞLAR  
P-SYSTEM CARTRIDGE  
P-SYSTEM KURZDREHHALTER

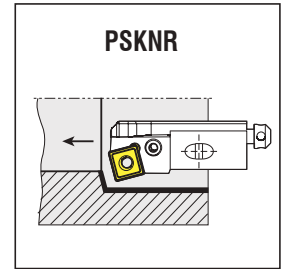
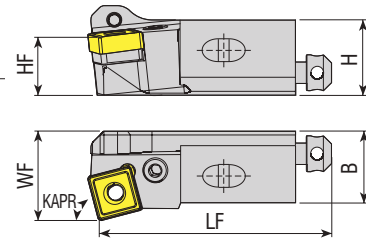
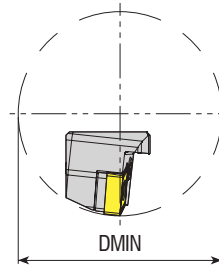

| Takım Kodu<br>Ordering Code<br>Bestell-Bezeichnung | Stok<br>Stock<br>Lager |   | Takım Ölçüleri (mm)<br>Dimension (mm)<br>Abmessung (mm) |    |    |    |    | Kesici Uç<br>Insert<br>Wendeschneidplatte | Yedek Parçaları / Spare Parts / Ersatzteile |                             |  |                             |   |   |
|--|------------------------|---|---|----|----|----|----|---|---|-----------------------------|--|-----------------------------|---|---|
|  | R                      | L | HF  | H  | B  | LF | WF |   | DMIN  | Levye<br>Lever<br>Kniehebel | Levye Vidası<br>Lever Screw<br>Kniehebelschraube | Altlık<br>Shim<br>Unterlage | Altlık Yayı<br>Shim Spring<br>Feder für Unterlage | Anahtar<br>Allen Key<br>Innensechskantschlüssel |
| PSKNR/L 16CA 12                                    | ●                      | ● | 16  | 21 | 20 | 63 | 25 | ≥60                                       |   | APL-02                      | ALV-08-M8x16                                     | AASN-3-0004                 | AAY-02  | AAL-02-2.5                                      |

R: Sağ / Right / Rechts L: Sol / Left / Links  
● Stokta / In Stock / Auf Lager ○ Stokta Yok / Non Stock Item / Kein Lagerartikel, Lieferzeit auf Anfrage

Sipariş Örneği/Ordering Example/Bestellbeispiel  
1 ad./pcs./stück STTCR 08CA 09



KAPR=75°

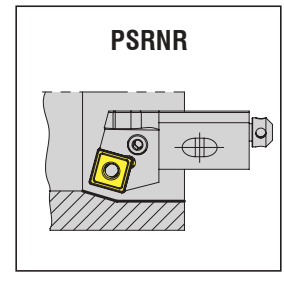
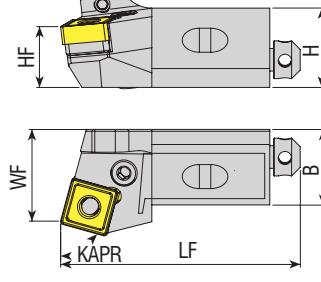
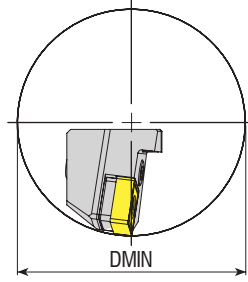

Takım Kodu  
Ordering Code  
Bestell-Bezeichnung

| Stok<br>Stock<br>Lager | Takım Ölçüleri (mm)<br>Dimension (mm)<br>Abmessung (mm) |   |    |    |    |    |    |      | Kesici Uç<br>Insert<br>Wendeschneidplatte | Yedek Parçaları / Spare Parts / Ersatzteile |  |                              |  |   |
|------------------------|---|---|----|----|----|----|----|------|---|---|--|------------------------------|--|---|
|                        | R   | L | HF | H  | B  | LF | WF | DMIN |   | Levyeye<br>Lever<br>Kniehebel               | Levyeye Vidası<br>Lever Screw<br>Kniehebelschraube | Altılık<br>Shim<br>Unterlage | Altılık Yayı<br>Shim Spring<br>Feder für Unterlage | Anahtar<br>Allen Key<br>Innensechskantschlüssel |
| PSNR/L 16CA 12         | ○   | ● | 16 | 21 | 20 | 63 | 25 | ≥60  |   | APL-02                                      | ALV-03-M8x19                                       | AASN-3-0004                  | AAV-02   | AAL-03-3  |

KAPR=90°

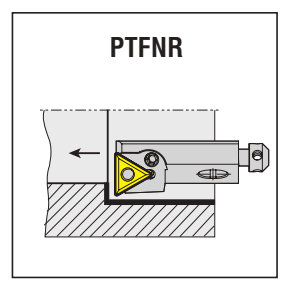
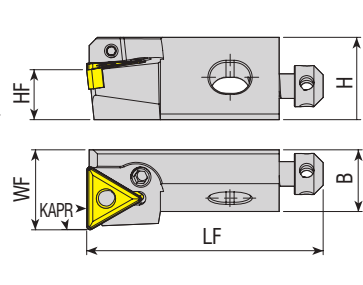
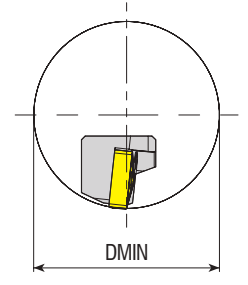

Takım Kodu  
Ordering Code  
Bestell-Bezeichnung

| Stok<br>Stock<br>Lager     | Takım Ölçüleri (mm)<br>Dimension (mm)<br>Abmessung (mm) |   |    |    |    |    |    |      | Kesici Uç<br>Insert<br>Wendeschneidplatte | Yedek Parçaları / Spare Parts / Ersatzteile |  |                              |  |   |
|----------------------------|---|---|----|----|----|----|----|------|---|---|--|------------------------------|--|---|
|                            | R   | L | HF | H  | B  | LF | WF | DMIN |   | Levyeye<br>Lever<br>Kniehebel               | Levyeye Vidası<br>Lever Screw<br>Kniehebelschraube | Altılık<br>Shim<br>Unterlage | Altılık Yayı<br>Shim Spring<br>Feder für Unterlage | Anahtar<br>Allen Key<br>Innensechskantschlüssel |
| PTFNR/L 12CA 16            | ●   | ● | 12 | 20 | 15 | 47 | 20 | ≥50  |   | APL-08                                      | ALV-07-M6x13                                       | -                            | AAV-07   | AAL-02-2.5                                      |
| PTFNR/L 16CA 16            | ●   | ○ | 16 | 21 | 20 | 63 | 25 | ≥60  | <b>TNM.160408</b>                         | APL-01                                      | ALV-01-M6x14                                       | AATN-3-0025                  | AAV-01   | AAL-02-2.5                                      |
| <b>new</b> PTFNR/L 16CA 22 | ○   | ● | 16 | 21 | 20 | 63 | 25 | ≥60  | <b>TNMG 2204.</b>                         | APL-02                                      | ALV-03-M8x19                                       | AATN-3-0015                  | AAV-02   | AAL-03-3  |
| <b>new</b> PTFNR/L 20CA 22 | ●   | ○ | 20 | 30 | 20 | 63 | 25 | ≥70  |   |   |  |                              |  |   |

**new**

KAPR=90°

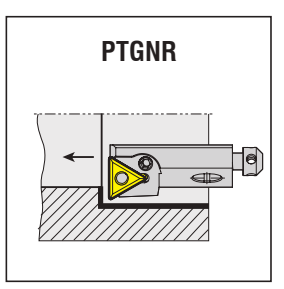
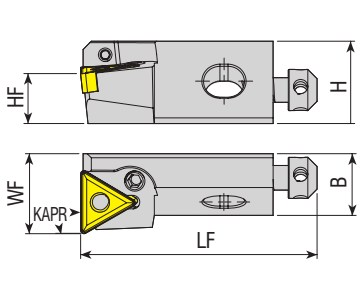
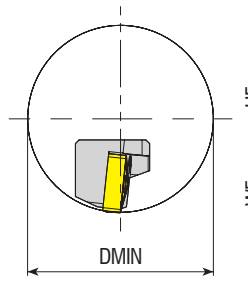

Takım Kodu  
Ordering Code  
Bestell-Bezeichnung

| Stok<br>Stock<br>Lager | Takım Ölçüleri (mm)<br>Dimension (mm)<br>Abmessung (mm) |   |    |    |    |    |    |      | Kesici Uç<br>Insert<br>Wendeschneidplatte | Yedek Parçaları / Spare Parts / Ersatzteile |  |                              |  |   |
|------------------------|---|---|----|----|----|----|----|------|---|---|--|------------------------------|--|---|
|                        | R   | L | HF | H  | B  | LF | WF | DMIN |   | Levyeye<br>Lever<br>Kniehebel               | Levyeye Vidası<br>Lever Screw<br>Kniehebelschraube | Altılık<br>Shim<br>Unterlage | Altılık Yayı<br>Shim Spring<br>Feder für Unterlage | Anahtar<br>Allen Key<br>Innensechskantschlüssel |
| PTGNR/L 16CA 22        | ●   | ● | 16 | 21 | 20 | 63 | 25 | 60   | <b>TNMG 2204..</b>                        | APL-02                                      | ALV-03-M8x19                                       | AATN-3-0015                  | AAV-02   | AAL-03-3  |

R: Sağ / Right / Rechts L: Sol / Left / Links  
● Stokta / In Stock / Auf Lager ○ Stokta Yok / Non Stock Item / Kein Lagerartikel, Lieferzeit auf Anfrage

Sipariş Örneği/Ordering Example/Bestellbeispiel  
1 ad./pcs./stück PSNR 16CA 12

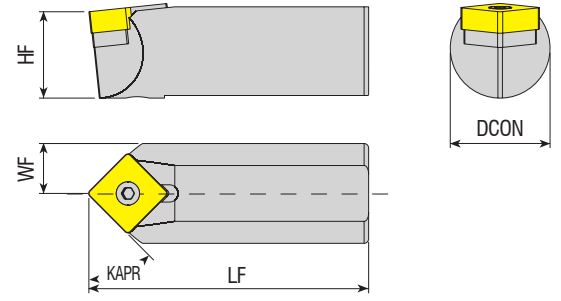

| Takım Kodu<br>Ordering Code<br>Bestell-Bezeichnung | Stok<br>Stock<br>Lager | Takım Ölçüleri (mm)<br>Dimension (mm)<br>Abmessung (mm) |      |    |    | Kesici Uç<br>Insert<br>Wendeschneidplatte | Yedek Parçaları / Spare Parts / Ersatzteile |  |   |  |  |
|--|------------------------|---|------|----|----|---|---|--|---|--|--|
|  |                        | DCON  | HF   | LF | WF |   | Aitlik<br>Shim<br>Unterlage                 | Sıkma Vidası<br>Screw<br>Klemmschraube | Baskı Parçası<br>Wedge Clamp<br>Spannpratze | Baskı Vidası<br>Clamp Screw<br>Klemmschraube | Tork Anahtar<br>Torx Key<br>Torx Innensechskantschlüssel |
| <b>S22D PSDNN 12C</b>                              | ●                      | 22  | 17.5 | 65 | 11 |   |   |  |   |  |  |
|  |                        |   |      |    |    | <b>SNM. 1204..</b>                        | AASN-20020                                  | AEV-01-M6x16                           | ACK-05                                      | 4015-M4x11                                   | AAL-02-2.5   |

R: Sağ / Right / Rechts L: Sol / Left / Links

● Stokta / In Stock / Auf Lager ○ Stokta Yok / Non Stock Item / Kein Lagerartikel, Lieferzeit auf Anfrage

Sipariş Örneği/Ordering Example/Bestellbeispiel

1 ad./pcs./stück S22D PSDNN 12C

KARTUŞLARIN YEDEK PARÇALARI  
SPARE PARTS OF CARTRIDGE  
ERSATZTEILE FÜR KURZDREHHALTER

| Takım Kodu<br>Ordering Code<br>Bestell-Bezeichnung | Yedek Parçaları / Spare Parts / Ersatzteile                     |  |  |   |   |          |
|--|---|--|--|---|---|----------|
|  | Eksenel Ayar Vida<br>Axial Adj. Screw<br>Axial-Einstellschraube | Radyal Ayar Vida<br>Radial Adj. Screw<br>Radial-Einstellschraube | Radyal Ayar Vida Anahtar<br>Radial Adj. Screw Allen Key<br>Innensechskantschlüssel für Radial-Einstellschraube | Montaj Vida<br>Mounting Screw<br>Befestigungsschraube | Montaj Vida Anahtar<br>Mounting Screw Allen Key<br>Innensechskantschlüssel für Befestigungsschraube |          |
| <b>SCFCR/L</b>                                     | 06CA 06   | 2600-M4x9.5  | 2715-M3x5  | AAL-09-1.5  | AKV-23-M4x10  | AAL-03-3 |
| <b>SCSCR/L</b>                                     | 08CA 06   | 2600-M4x9.5  | 2715-M3x5  | AAL-09-1.5  | AKV-23-M4x10  | AAL-03-3 |
| <b>SSKCR/L</b>                                     | 10CA 09   | 2600-M5x13   | 2702-M4x10   | AAL-01-2  | 2505-M6x16  | AAL-03-3 |
|  | 12CA 12   | 2600-M5x13   | 2702-M4x10   | AAL-01-2  | 2505-M6x16  | AAL-03-3 |
|  | 16CA 12   | 2600-M6x18   | 2725-M5x12   | AAL-02-2.5  | 2005-M8x25  | AAL-07-5 |
| <b>STSCR/L</b>                                     | 08CA 09   | 2600-M4x9.5  | 2715-M3x5  | AAL-09-1.5  | AKV-23-M4x10  | AAL-03-3 |
| <b>STTCR/L</b>                                     | 10CA 11   | 2600-M5x13   | 2702-M4x10   | AAL-01-2  | 2505-M6x16  | AAL-03-3 |
| <b>STFCR/L</b>                                     | 12CA 16   | 2600-M5x13   | 2702-M4x10   | AAL-01-2  | 2505-M6x16  | AAL-03-3 |
|  | 16CA 16   | 2600-M6x18   | 2725-M5x12   | AAL-02-2.5  | 2005-M8x25  | AAL-07-5 |
| <b>PTFNR/L</b>                                     | 12CA 16   | 2600-M5x13   | 2702-M4x4  | AAL-01-2  | 2505-M6x16  | AAL-03-3 |
| <b>PSKNR/L</b>                                     | 16CA 16   | 2600-M6x18   | 2725-M5x6  | AAL-02-2.5  | 2005-M8x25  | AAL-07-5 |
| <b>PSRNR/L</b>                                     | 16CA 12   | 2600-M6x18   | 2725-M5x6  | AAL-02-2.5  | 2005-M8x25  | AAL-07-5 |



| Takım Kodu<br>Ordering Code<br>Bestell-Bezeichnung | Stok<br>Stock<br>Lager | Ölçü Aralığı (mm)<br>Boring Range (mm)<br>Bohrbereich (mm) |                |              |                |                                     | Kartuşlar<br>Cartridge<br>Kurzdrehhalter | Gövde Takım Kodu<br>Body Tool Code<br>Grundkörper-Bezeichnung | Teknik Çizim<br>Technical Draw<br>Technische Zeichnung |
|--|------------------------|--|----------------|--------------|----------------|-------------------------------------|--|---|--|
|  |                        | D max  |                | D min        |                | Max<br>(D dış-D iç)<br>(D out-D in) |  |   |  |
|  |                        | D iç<br>D in   | D dış<br>D out | D iç<br>D in | D dış<br>D out |                                     |  |   |  |
| ACPBT-1  | ●                      | 27-52  | 52             | 18-36        | 36             | 27                                  | ÖTG-K-120-20                             |   |  |
| ACPBT-2  | ●                      | 27-49  | 52             | 25-36        | 36             | 27                                  |  |   |  |
| ACPBT-3  | ●                      | 48-75  | 75             | 41           | 42             | 27                                  |  |   |  |
| ACPBT-4  | ●                      | 51-75  | 75             | 51           | 52             | 27                                  |  |   |  |
| ACPBT-5  | ●                      | 22-35  | 35             | 22           | 23             | 27                                  |  |   |  |
| ACPBT-6  | ●                      | 15-35  | 35             | 15           | 16             | 27                                  |  |   |  |
| ACPBT-7  | ●                      | 49-53  | 75             | 32-36        | 36             | 27                                  |  |   |  |
| ACPBT-8  | ●                      | 49   | 75             | 33-37        | 37             | 27                                  |  |   |  |

| Takım Kodu<br>Ordering Code<br>Bestell-Bezeichnung | Stok<br>Stock<br>Lager | Ölçü Aralığı (mm)<br>Boring Range (mm)<br>Bohrbereich (mm) |       |       |       |                                     | Kartuşlar<br>Cartridge<br>Kurzdrehhalter | Gövde Takım Kodu<br>Body Tool Code<br>Grundkörper-Bezeichnung | Teknik Çizim<br>Technical Draw<br>Technische Zeichnung |
|--|------------------------|--|-------|-------|-------|-------------------------------------|--|---|--|
|  |                        | D1   |       | D2    |       | Max<br>(D dış-D iç)<br>(D out-D in) |  |   |  |
|  |                        | D max  | D min | D max | D min |                                     |  |   |  |
| ACPBT-9  | ●                      | 38   | 24    | 15    | 1     | -                                   | ÖTG-K-120-20                             |   |  |
| ACPBT-10   | ●                      | 78   | 64    | 43    | 29    | -                                   |  |   |  |

R: Sağ / Right / Rechts L: Sol / Left / Links

● Stokta / In Stock / Auf Lager ○ Stokta Yok / Non Stock Item / Kein Lagerartikel, Lieferzeit auf Anfrage

Sipariş Örneği / Ordering Example / Bestellbeispiel  
1 ad./pcs./stück ACPBT-1



*konusulan  
the spoken kalite...  
quality...*

# DİŞ AÇMA

DİŞ AÇMA TAKIMLARI  
THREADING TOOLHOLDERS  
GEWINDE DREHHALTER





**S** **E** **R** **25 25** **M** **16** **C**

**1** Sıkma Tipi / Method of Mounting of Insert  
Klemmsystem

S: Vida Sıkmalı  
S: Screw Clamping / S Schrauben-Spannsystem  
T: Vida Sıkmalı Helis Açılı  
T: Screw Clamping with Helix Angle  
T: Schraubenklemmung für unterschiedliche Einstellwinkel

**2** İşlem Tipi / Application  
Anwendung

E: Dış / External  
Außen  
I: İç / Internal /  
Innen

**3** Kesme Yönü  
Cutting Direction  
Halterausführung

R: Sağ Yan  
Right-Hand  
R: Rechts  
L: Sol Yan  
Left-Hand  
L: Links

**4** Takım Malzemesi / Type of Boring / Art der Bohrstange

"A" Yekpare çelik gövde soğutma suyu kanallı / "A" Solid steel with coolant hole  
 A" Stahlschaft mit Kühlbohrung SEITE 123  
 "E" Çelik başlıkla sert metal gövde ve soğutma suyu kanallı / "E" Carbide bar with fixed steel head and coolant hole  
 "E" Hartmetallstange mit festem Stahlkopf und Kühlmittelbohrung  
 "C" Karbür Şaft / "C" Carbide shank / "C" Hartmetallschaft  
 "S" Çelik Şaft / "S" Steel shank / "S" Stahlschaft

**4-5** Dış Çap Şaft Ölçüleri / External Shank Size  
Äußere Schaftgröße

Şaft / Shank / Schaftausführung: hxb  
2525 - 25 x 25 mm

**5** Şaft Çapı / Shank Diameter  
Schaft-Durchmesser

**6** Şaft Boyu / Shank Length / Schaftlänge

|        |         |         |           |
|--------|---------|---------|-----------|
| A - 32 | H - 100 | Q - 180 | x-special |
| B - 40 | J - 110 | R - 200 |           |
| C - 50 | K - 125 | S - 250 |           |
| D - 60 | L - 140 | T - 300 |           |
| E - 70 | M - 150 | U - 350 |           |
| F - 80 | N - 160 | V - 400 |           |
| G - 90 | P - 170 | W - 450 |           |

**7** Elmas Ölçüsü / Insert Size  
Wendeplattengröße

| l (mm) | d     |
|--------|-------|
| 06     | 5/32" |
| 08     | 3/16" |
| 11     | 1/4"  |
| 16     | 3/8"  |
| 22     | 1/2"  |
| 27     | 5/8"  |

**8** Baskı Pabucu  
Wedge Clamp  
Spannpratze

**S** **I** **R** **S** **25** **R** **16** **C**

DIŞ ÇAP DIŞ AÇMA KATERLERİ  
EXTERNAL THREADING TOOLHOLDERS  
INNEN-GEWINDEDREHHALTER

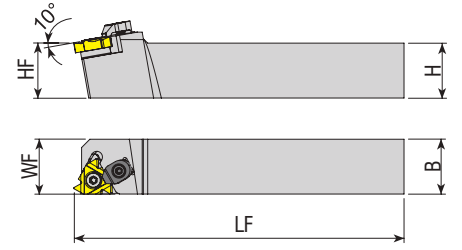
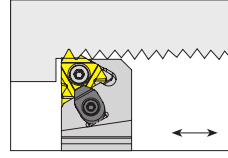

**Takım Kodu**  
**Ordering Code**  
*Bestell-Bezeichnung*

| Stok<br>Stock<br>Lager | Takım Ölçüleri (mm)<br>Dimension (mm)<br>Abmessung (mm) |   |      |    |     |      | Kesici Uç<br>Insert<br>Wendeschneidplatte | Sıkma Vidası<br>Screw<br>Klemmschraube | Altlık<br>Shim<br>Unterlage | Altlık Vidası<br>Shim Screw<br>Schraube für Unterlage | Baskı Parçası<br>Wedge Clamp<br>Spannpratze | Baskı Vidası<br>Clamp Screw<br>Klemmschraube | Tork Anahtar<br>Torx<br>Immersionschlüssel |
|------------------------|---|---|------|----|-----|------|---|--|-----------------------------|---|---|--|--|
|                        | R   | L | HF=H | B  | LF  | WF   |   |  |                             |   |   |  |  |
|                        |   |   |      |    |     |      |   |  |                             |   |   |  |  |
| SER/L 0808 E11         | ●   | ● | 08   | 08 | 70  | 11   | 11 ER/EL                                  | 4008-M2.5x6                            | -                           | -   | -   | -  | 82-T08                                     |
| SER/L 1010 E11         | ●   | ● | 10   | 10 | 70  | 11   |   |  |                             |   |   |  |  |
| SER/L 1212 F11         | ●   | ● | 12   | 12 | 80  | 12   |   |  |                             |   |   |  |  |
| SER/L 1616 H11         | ●   | ● | 16   | 16 | 100 | 16   |   |  |                             |   |   |  |  |
| SER/L 2020 H11         | ●   | ● | 20   | 20 | 100 | 20   | 16 ER/EL<br>(0.35 - 3)<br>ISO METRIC      | 4015-M3.5x14                           | AATN-2-0020                 | AAV-06-M3.5x11  | -   | -  | 80-T15                                     |
| SER/L 1616 H16C        | ●   | ● | 16   | 16 | 100 | 16   |   |  |                             |   |   |  |  |
| SER/L 2020 K16C        | ●   | ● | 20   | 20 | 125 | 20   |   |  |                             |   |   |  |  |
| SER/L 2525 M16C        | ●   | ● | 25   | 25 | 150 | 25   |   |  |                             |   |   |  |  |
| SER/L 3232 P16C        | ●   | ● | 32   | 32 | 170 | 32   | 22 ER/EL<br>(3.5 - 4.5)<br>ISO METRIC     | 1020-M4.5x16                           | AATN-2-0004                 | AAV-07-M4.5x13  | ACK-05                                      | 4015 M4x11                                   | 80-T20                                     |
| SER/L 2525 M22C        | ●   | ● | 25   | 25 | 150 | 25   |   |  |                             |   |   |  |  |
| SER/L 3232 P22C        | ●   | ● | 32   | 32 | 170 | 32   |   |  |                             |   |   |  |  |
| SER/L 4040 S22C        | ●   | ● | 40   | 40 | 250 | 40   |   |  |                             |   |   |  |  |
| SER/L 2525 M16C-T      | ●   | ● | 25   | 25 | 150 | 25   | 16 ER/L (1.5-3 TR)                        | 4015-M3.5x14                           | -                           | -   | -   | -  | 80-T15                                     |
| SER/L 2525 M22C-T      | ●   | ● | 25   | 25 | 150 | 25   | 22 ER/L (4-6 TR)                          | 1020-M4.5x16                           | -                           | -   | -   | -  | 80-T20                                     |
| SER/L 2020 K16C-S      | ●   | ● | 20   | 20 | 125 | 25   | SNDVK 166 ER/L16                          | 4015-M3.5x14                           | AATN-2-0020                 | AAV-06-M3.5x11  | -   | -  | 80-T15                                     |
| SER/L 2525 M16C-S      | ●   | ● | 25   | 25 | 150 | 31   |   |  |                             |   |   |  |  |
| SER/L 3232 P16C-S      | ●   | ● | 32   | 32 | 170 | 38.5 |   |  |                             |   |   |  |  |

DIŞ ÇAP DIŞ AÇMA İSVİÇRE TİPİ KAYAR OTOMAT MAKİNA KATERLERİ  
EXTERNAL THREADING TOOLHOLDERS FOR SWISS TYPE SLIDING AUTOMATIC LATHES  
AUSSEN-GEWINDEDREHHALTER FÜR LANGDREHAUTOMATEN

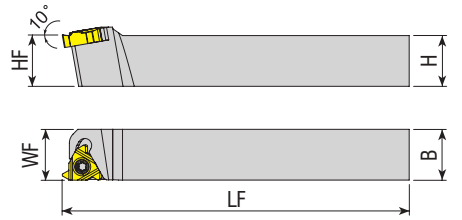
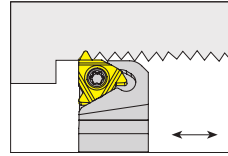

**Takım Kodu**  
**Ordering Code**  
*Bestell-Bezeichnung*

| Stok<br>Stock<br>Lager      | Takım Ölçüleri (mm)<br>Dimension (mm)<br>Abmessung (mm) |   |      |    |     |    | Kesici Uç<br>Insert<br>Wendeschneidplatte | Sıkma Vidası<br>Screw<br>Klemmschraube | Altlık<br>Shim<br>Unterlage | Altlık Vidası<br>Shim Screw<br>Schraube für Unterlage | Baskı Parçası<br>Wedge Clamp<br>Spannpratze | Baskı Vidası<br>Clamp Screw<br>Klemmschraube | Tork Anahtar<br>Torx<br>Immersionschlüssel |
|-----------------------------|---|---|------|----|-----|----|---|--|-----------------------------|---|---|--|--|
|                             | R   | L | HF=H | B  | LF  | WF |   |  |                             |   |   |  |  |
|                             |   |   |      |    |     |    |   |  |                             |   |   |  |  |
| SER/L 1010 K11-S            | ●   | ● | 10   | 10 | 125 | 10 | 11 ER/EL                                  | 4008-M2.5x6                            | -                           | -   | -   | -  | 82-T08                                     |
| SER/L 1212 K11-S            | ●   | ● | 12   | 12 | 125 | 12 |   |  |                             |   |   |  |  |
| <b>new</b> SER/L 1212 K16-S | ●   | ● | 12   | 12 | 125 | 12 | 16 ER 3.5                                 | 4015-M3.5x14                           | AATN-2-0020                 | AAV-08-M3.5x8   | -   | -  | 80-T15                                     |

R: Sağ / Right / Rechts L: Sol / Left / Links ● Stokta / In Stock / Auf Lager ○ Stokta Yok / Non Stock Item / Kein Lagerartikel, Lieferzeit auf Anfrage  
Takımlar standart 1.5° helis açılı olarak üretilir. / The tools have a built in 1.5° helix angle. / GEWINDE-DREHHALTER werden mit Einstellwinkel 1.5° hergestellt  
UYARI / WARNING / ПРЕДУПРЕЖДЕНИЕ: Sayfa 114'deki B ve D figürleri uygulanamaz. / The operation for B and D on page 114 can not be applied. / 130: für Abbildung B und D, nicht verwenden

Sipariş Örneği/Ordering Example/Bestellbeispiel  
1 ad./pcs./stück SER 0808 E11



www.akko.com.tr

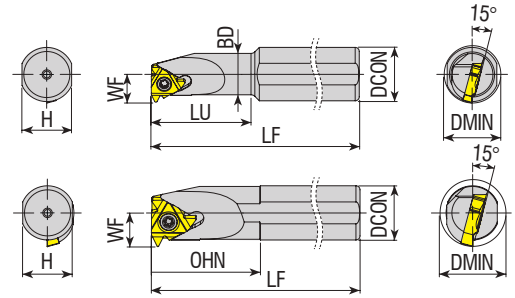
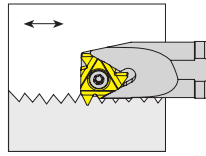

**Takım Kodu**  
**Ordering Code**  
**Bestell-Bezeichnung**

| Takım Kodu<br>Ordering Code<br>Bestell-Bezeichnung | Stok<br>Stock<br>Lager |   | Takım Ölçüleri (mm)<br>Dimension (mm)<br>Abmessung (mm) |      |     |        |      | Kesici Uç<br>Insert<br>Wendeschneidplatte | Yedek Parçaları / Spare Parts / Ersatzteile |  |                             |   |   |  |   |
|--|------------------------|---|---|------|-----|--------|------|---|---|--|-----------------------------|---|---|--|---|
|  | R                      | L | DCON  | BD   | LF  | LU=OHN | WF   |   | DMIN  | Sıkma Vidası<br>Screw<br>Klemmschraube | Ahtlık<br>Shim<br>Unterlage | Ahtlık Vidası<br>Shim Screw<br>Schraube für Unterlage | Baskı Parçası<br>Wedge Clamp<br>Spannpratze | Baskı Vidası<br>Clamp Screw<br>Klemmschraube | Tork Anahtar<br>Torx Key<br>Torx Innenschlüssel |
| SIR/L S12X05H 06                                   | ●                      | ○ | 12  | 05   | 100 | 15     | 4.3  | 6.4                                       | 06 IR/L                                     | 3006-M2X3.6                            | -                           | -   | -   | -  | 82-T06  |
| SIR/L S16X05H 06                                   | ○                      | ● | 16  | 05   | 100 | 15     | 4.3  | 6.4                                       |   |  |                             |   |   |  |   |
| SIR/L S16X07M 08                                   | ●                      | ● | 16  | 07   | 150 | 18     | 5.3  | 7.8                                       |   |  |                             |   |   |  |   |
| SIR/L S10H 11                                      | ●                      | ● | 10  | 10   | 100 | -      | 7.4  | 12  | 11 IR/L                                     | 4008-M2.5x6                            | -                           | -   | -   | -  | 82-T08  |
| SIR/L S12K 11                                      | ●                      | ● | 12  | 12   | 125 | -      | 8.4  | 15  |   |  |                             |   |   |  |   |
| SIR/L S16X10M 11                                   | ●                      | ● | 16  | 10   | 150 | 25     | 7.4  | 12  |   |  |                             |   |   |  |   |
| SIR/L S16X13M 11                                   | ●                      | ● | 16  | 13   | 150 | 32     | 8.9  | 15  |   |  |                             |   |   |  |   |
| SIR/L S16M 11                                      | ●                      | ● | 16  | 16   | 150 | -      | 11.7 | 19  |   |  |                             |   |   |  |   |
| new SIR/L A16X13M 16                               | ●                      | ● | 16  | 12.8 | 150 | 32     | 9.05 | 18.1                                      | 16 IR/L<br>(0.35 - 3)<br>ISO METRIC         | 4015-M3.5x9                            | -                           | -   | -   | -  | 80-T15  |
| SIR/L S16X13M 16                                   | ●                      | ● | 16  | 13   | 150 | 32     | 10.2 | 16  |   |  |                             |   |   |  |   |
| SIR/L S16M 16                                      | ●                      | ● | 16  | 16   | 150 | -      | 11.7 | 19  |   |  |                             |   |   |  |   |
| SIR/L S20X16P 16                                   | ●                      | ● | 20  | 16   | 170 | 40     | 11.7 | 19  |   |  |                             |   |   |  |   |
| new SIR/L A20X16P 16                               | ●                      | ● | 20  | 31   | 170 | 40     | 11.7 | 19  |   |  |                             |   |   |  |   |
| SIR/L S20P 16                                      | ●                      | ● | 20  | 20   | 170 | -      | 13.7 | 24  |   |  |                             |   |   |  |   |
| SIR/L S25R 16C                                     | ●                      | ● | 25  | 25   | 200 | -      | 16.2 | 29  |   |  |                             |   |   |  |   |
| SIR/L S32S 16C                                     | ●                      | ● | 32  | 32   | 250 | -      | 19.7 | 36  |   |  |                             |   |   |  |   |
| SIR/L S40T 16C                                     | ●                      | ● | 40  | 40   | 300 | -      | 23.7 | 44  |   |  |                             |   |   |  |   |
| SIR/L S50U 16C                                     | ●                      | ● | 50  | 50   | 350 | -      | 28.7 | 54  |   |  |                             |   |   |  |   |
| SIR/L S20P 22                                      | ●                      | ● | 20  | 20   | 170 | -      | 15.7 | 24  | 22 IR/L<br>(3.5 - 4.5)<br>ISO METRIC        | 4020-M4.5x12                           | -                           | -   | -   | -  | 80-T20  |
| SIR/L S25R 22C                                     | ●                      | ● | 25  | 25   | 200 | -      | 18.1 | 29  |   |  |                             |   |   |  |   |
| SIR/L S32S 22C                                     | ●                      | ● | 32  | 32   | 250 | -      | 21.6 | 38  |   |  |                             |   |   |  |   |
| SIR/L S40T 22C                                     | ●                      | ● | 40  | 40   | 300 | -      | 25.6 | 46  |   |  |                             |   |   |  |   |
| SIR/L S50U 22C                                     | ●                      | ● | 50  | 50   | 350 | -      | 30.6 | 58  |   |  |                             |   |   |  |   |
| SIR/L S25R 16C-T                                   | ●                      | ● | 25  | 25   | 200 | -      | 16.2 | 29  |   |  |                             |   |   |  |   |
| SIR/L S32S 16C-T                                   | ●                      | ● | 32  | 32   | 250 | -      | 19.7 | 36  | 22 IR/L (4-6 TR)                            | 1020-M4.5x16                           | -                           | -   | -   | -  | 80-T20  |
| SIR/L S25R 22C-T                                   | ●                      | ● | 25  | 25   | 200 | -      | 18.1 | 29  |   |  |                             |   |   |  |   |
| SIR/L S32S 22C-T                                   | ●                      | ● | 32  | 32   | 250 | -      | 21.6 | 38  |   |  |                             |   |   |  |   |
| new SIR/L S40T 27V T08                             | ●                      | ● | 40  | 39.5 | 300 | 70     | 29   | 50  | 27VNR10TR NNT                               | 1620-M5X18                             | -                           | -   | -   | -  | -   |

R: Sağ / Right / Rechts L: Sol / Left / Links ● Stokta / In Stock / Auf Lager ○ Stokta Yok / Non Stock Item / Нет в наличии  
Takımlar standart 1.5° helis açılı olarak üretilir. / The tools have a built in 1.5° helix angle. / GEWINDE-DREHHALTER werden mit Einstellwinkel 1.5° hergestellt  
UYARI / WARNING / ПРЕДУПРЕЖДЕНИЕ: Sayfa 115'deki B ve D figürleri uygulanamaz. / The operation for B and D on page 115 can not be applied. / 130. für Abbildung B und D: nicht verwenden

Sipariş Örneği/Ordering Example/Bestellbeispiel  
1 ad./pcs./stück SIR S12X05H 06

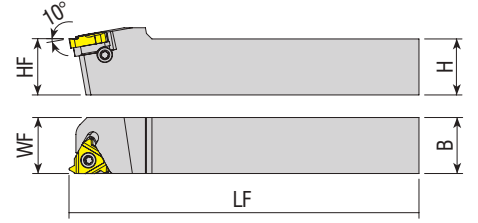
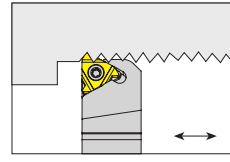

| Takım Kodu<br>Ordering Code<br>Bestell-Bezeichnung | Stok<br>Stock<br>Lager |   | Takım Ölçüleri (mm)<br>Dimension (mm)<br>Abmessung (mm) |    |     |    | Kesici Uç<br>Insert<br>Wendeschneidplatte | Yedek Parçaları / Spare Parts / Ersatzteile |   |   |   |   |  |
|--|------------------------|---|---|----|-----|----|---|---|---|---|---|---|--|
|  | R                      | L | HF=H  | B  | LF  | WF |   | Sıkma Vidası<br>Screw<br>Klemmschraube      | Sağ Altlık<br>Right Shim<br>U-Platte für WSP rechts | Sol Altlık<br>Left Shim<br>U-Platte für WSP links | Altlık Vidası<br>Shim Screw<br>Schraube für Unterlage | Altlık Vidası Pulu<br>Shim Screw Ring<br>Schraube für Unterlagering | Tork Anahtar<br>Torx Key<br>Torx / Innenschlankschlüssel |
| TER/L 1616 H16                                     | ●                      | ● | 16  | 16 | 100 | 16 | 16 ER/EL                                  |   |   |   |   |   |  |
| TER/L 2020 K16                                     | ●                      | ● | 20  | 20 | 125 | 20 |   |   |   |   |   |   |  |
| TER/L 2525 M16                                     | ●                      | ● | 25  | 25 | 150 | 25 |   |   |   |   |   |   |  |
| TER/L 3232 P16                                     | ●                      | ● | 32  | 32 | 170 | 32 | 22 ER/EL                                  |   |   |   |   |   |  |
| TER/L 2525 M22                                     | ●                      | ● | 25  | 25 | 150 | 25 |   |   |   |   |   |   |  |
| TER/L 3232 P22                                     | ●                      | ● | 32  | 32 | 170 | 32 |   |   |   |   |   |   |  |
| TER/L 4040 S22                                     | ●                      | ● | 40  | 40 | 250 | 40 | 27 ER/EL                                  |   |   |   |   |   |  |
| TER/L 2525 M27                                     | ●                      | ● | 25  | 25 | 150 | 25 |   |   |   |   |   |   |  |
| TER/L 3232 P27                                     | ●                      | ● | 32  | 32 | 170 | 32 |   |   |   |   |   |   |  |
| TER/L 4040 S27                                     | ●                      | ● | 40  | 40 | 250 | 40 |   |   |   |   |   |   |  |

R: Sağ / Right / Rechts L: Sol / Left / Links ● Stokta / In Stock / Auf Lager ○ Stokta Yok / Non Stock Item / Kein Lagerartikel, Lieferzeit auf Anfrage  
Takımlar standart 1.5° helis açılı olarak üretilir. / The tools have a built in 1.5° helix angle. / GEWINDE-DREHHALTER werden mit Einstellwinkel 1.5° hergestellt

Sipariş Örneği/Ordering Example/Bestellbeispiel  
1 ad./pcs./stück TER 1616 H16

DIŞ ÇAP SAĞ YÖNDE VİDA AÇMA  
EXTERNAL RIGHT HAND THREADING OPERATION  
HERSTELLUNG VON AUßEN-RECHTSGEWINDE

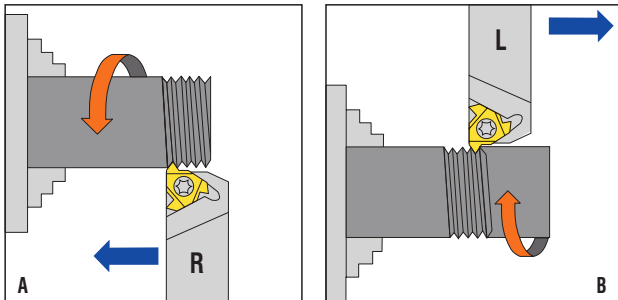

DIŞ ÇAP SOL YÖNDE VİDA AÇMA  
EXTERNAL LEFT HAND THREADING OPERATION  
HERSTELLUNG VON AUßEN-LINKSGEWINDE

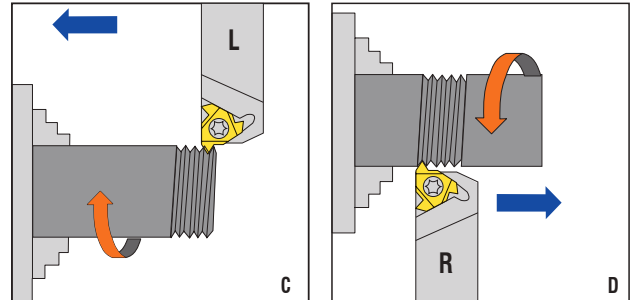

UYARI / WARNING / ACHTUNG

Figür B ve D için; negatif açılı altlık kullanılmalıdır. / For figure B and D; negative shim must be used. / Für Abbildung B und D; negative Unterlage verwenden.

Altiksız katederlerde B ve D figürü uygulanamaz. / B and D figures can not be applied on tools without shim. / Für Abbildung B und D; kann nicht mit Werkzeugen ohne Unterlegplatte erfolgen.



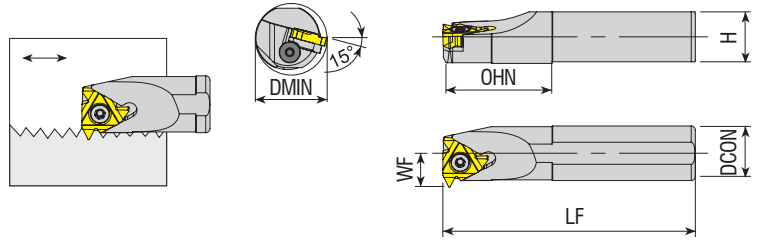

| Takım Kodu<br>Ordering Code<br>Bestell-Bezeichnung | Stok<br>Stock<br>Lager |   | Takım Ölçüleri (mm)<br>Dimension (mm)<br>Abmessung (mm) |      |     |     |      | Kesici Uç<br>Insert<br>Wendeschneidplatte | Yedek Parçaları / Spare Parts / Ersatzteile |  |   |   |   |   |  |
|--|------------------------|---|---|------|-----|-----|------|---|---|--|---|---|---|---|--|
|  | R                      | L | DCON  | H    | LF  | OHN | WF   |   | DMIN  | Sıkma Vidası<br>Screw<br>Klemmschraube | Sol Aittik<br>Left Shim<br>U-Platte für WSP links | Sağ Aittik<br>Right Shim<br>U-Platte für WSP rechts | Aittik Vidası<br>Shim Screw<br>Schraube für Unterlage | Aittik Vidası Pulu<br>Shim Screw Ring<br>Schraube für Unterlagerung | Tork Anahtar<br>Torx Key<br>Torx Innensechskantschlüssel |
| TIR/L S25R 16                                      | ●                      | ● | 25  | 23   | 200 | -   | 16.2 | 29  | 16 IR/L                                     | 1710-U5-40x12.2                        | ATS-16E   | ATS-16I   | AAV-11-U5-40x4.5                                      | ABPL-03   | 82-T10   |
| TIR/L S32S 16                                      | ●                      | ● | 32  | 30   | 250 | -   | 19.7 | 36  |   |  |   |   |   |   |  |
| TIR/L S40T 16                                      | ●                      | ● | 40  | 37.5 | 300 | -   | 23.7 | 44  |   |  |   |   |   |   |  |
| TIR/L S50U 16                                      | ●                      | ● | 50  | 47   | 350 | -   | 28.7 | 54  |   |  |   |   |   |   |  |
| TIR/L S25R 22                                      | ●                      | ● | 25  | 23   | 200 | -   | 18.1 | 29  | 22 IR/L                                     | 1720-U8-32x15                          | ATS-22E   | ATS-22I   | AAV-12-U8-32x5.5                                      | ABPL-04   | 80-T20   |
| TIR/L S32S 22                                      | ●                      | ● | 32  | 30   | 250 | -   | 21.6 | 38  |   |  |   |   |   |   |  |
| TIR/L S40T 22                                      | ●                      | ● | 40  | 37.5 | 300 | -   | 25.6 | 46  |   |  |   |   |   |   |  |
| TIR/L S50U 22                                      | ●                      | ● | 50  | 47   | 350 | -   | 30.6 | 58  |   |  |   |   |   |   |  |
| TIR/L S32S 27                                      | ●                      | ● | 32  | 30   | 250 | -   | 22.6 | 40  | 27 IR/L                                     | 1620-M5x18                             | ATS-27E   | ATS-27I   | AAV-15-M5x5.7   | ABPL-05   | 80-T20   |
| TIR/L S40T 27                                      | ●                      | ● | 40  | 37.5 | 300 | -   | 26.6 | 48  |   | 1620-M5x22                             |   |   |   |   |  |
| TIR/L S50U 27                                      | ●                      | ● | 50  | 47   | 350 | -   | 31.6 | 58  |   |  |   |   |   |   |  |
| new TIR/L A20P 16                                  | ●                      | ○ | 20  | 13.7 | 170 | 40  | 18   | 24  | 16 IR/L                                     | 1710-U5-40x12.2                        | ATS-16E   | ATS-16I   | AAV-11-U5-40x4.5                                      | ABPL-03   | 82-T10   |
| TIR/L A25R 16                                      | ○                      | ● | 25  | 23   | 200 | 50  | 16.2 | 29  |   |  |   |   |   |   |  |
| TIR/L A32S 16                                      | ○                      | ● | 32  | 30   | 250 | 60  | 19.7 | 36  |   |  |   |   |   |   |  |
| TIR/L A40T 16                                      | ○                      | ● | 40  | 37.5 | 300 | 65  | 23.9 | 44  |   |  |   |   |   |   |  |

R: Sağ / Right / Rechts L: Sol / Left / Links ● Stokta / In Stock / Auf Lager ○ Stokta Yok / Non Stock Item / Kein Lagerartikel, Lieferzeit auf Anfrage  
Takımlar standart 1.5° helis açılı olarak üretilir. / The tools have a built in 1.5° helix angle. / GEWINDE-DREHHALTER werden mit Einstellwinkel 1.5° hergestellt

Sipariş Örneği/Ordering Example/Bestellbeispiel  
1 ad./pcs./stück TIR S25R 16

DELİK İÇİ SAĞ YÖNDE VİDA AÇMA  
INTERNAL RIGHT HAND THREADING OPERATION  
HERSTELLUNG VON INNEN-RECHTSGEWINDE

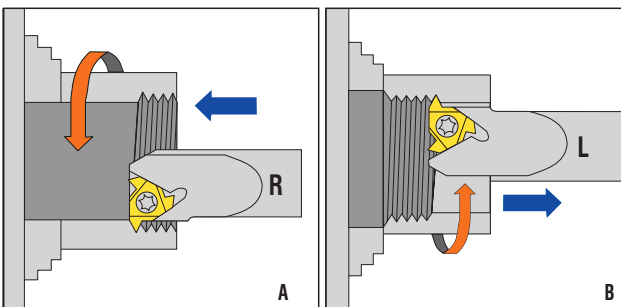

DELİK İÇİ SOL YÖNDE VİDA AÇMA  
INTERNAL LEFT HAND THREADING OPERATION  
HERSTELLUNG VON INNEN-LINKSGEWINDE

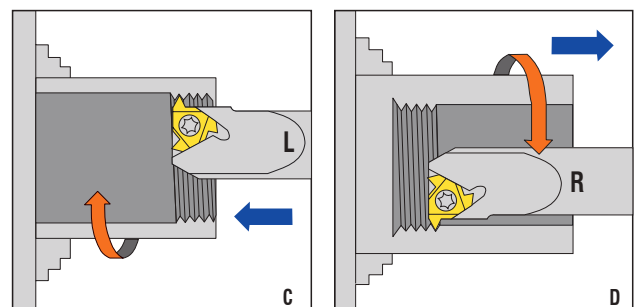

UYARI / WARNING / ACHTUNG

Figür B ve D için; negatif açılı aittik kullanılmalıdır. / For figure B and D; negative shim must be used. / Für Abbildung B und D; negative Unterlage verwenden.  
Aittiksiz katerlerde B ve D figürü uygulanamaz. / B and D figures can not be applied on tools without shim. / Für Abbildung B und D; kann nicht mit Werkzeugen ohne Unterlegplatte erfolgen.

## Diş Helis Açısı Thread Helix Angle Steigungswinkel

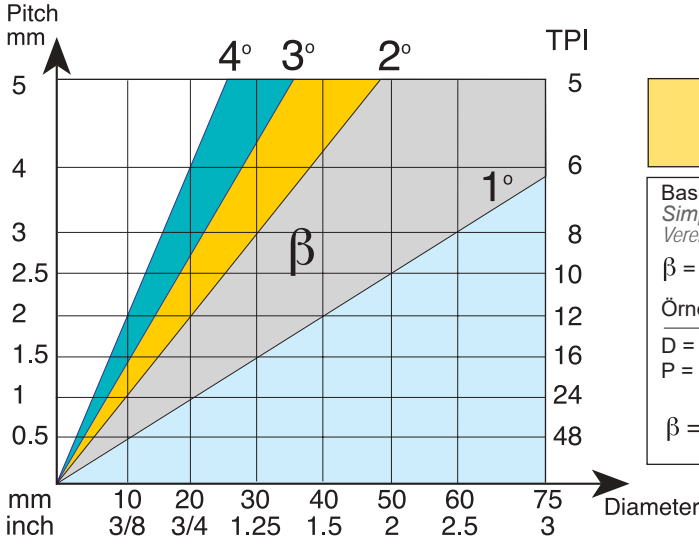

$$\tan \beta = \frac{P}{\pi \times D}$$

Basitleştirilmiş formül  
 Simplified formula  
 Vereinfachte Formel

$$\beta = 20 P/D$$

Örnek / Example / Beispiel :

D = 25 mm (0.98")  
 P = 1.5 mm (16 TPI)

$$\beta = \frac{20 \times 1.5}{25} = 1.2^\circ$$

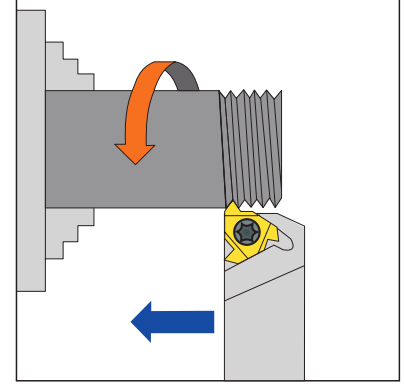

## Standart ve Eğik Altlıklar Standard and Slanted Shim Standard und Schräge Unterlegplatte

Akko diş açma takımlarının, uç yuvaları 1.5° helis açılı olarak üretilir. Farklı helis açılı diş açmak isteyenler altlığı değiştirerek istedikleri dereceyi elde edebilirler. Negatif helis genellikle sol katerde sağ diş çekmek için kullanılır ya da sağ katerde sol diş çekmek için kullanılır.

Akko Toolholders Pockets have a built in 1.5° helix angle. This angle may be adjusted to better match the thread helix angle by simply changing the shim. Negative helix is usually used when threading RH thread with LH Holder or LH thread with RH Holder.

Die Akko-Gewindedrehhalter werden mit 1,5°-Steigungswinkel produziert. Durch Wechseln der Unterlage kann dieser Winkel dem optimalen Steigungswinkel angepasst werden. Die Unterlagen mit negativem Winkel werden eingesetzt, wenn ein Rechtsgewinde mit einem linken Halter oder ein Linksgewinde mit einem rechten Halter gefertigt werden soll.

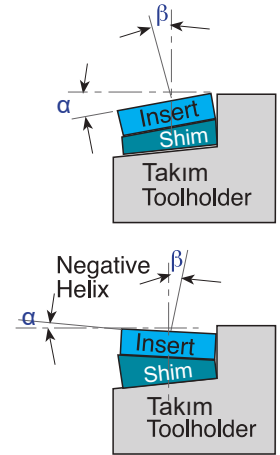

| L  | IC  | Takım Tipi<br>Tool Type<br>Werkzeugtyp | Uç Yuvasının Açısı (α) / Pocket's Angle (α) / Winkel Wendeplattensitz (α) |             |             |         |             |             |             |
|----|-----|--|---|-------------|-------------|---------|-------------|-------------|-------------|
|    |     |  | 4.5°  | 3.5°        | 2.5°        | 1.5°    | 0.5°        | -0.5°       | -1.5°       |
| 16 | 3/8 | EX-RH or IN-LH                         | ATS-16E+4.5   | ATS-16E+3.5 | ATS-16E+2.5 | ATS-16E | ATS-16E+0.5 | ATS-16E-0.5 | ATS-16E-1.5 |
| 16 | 3/8 | EX-LH or IN-RH                         | ATS-16I+4.5   | ATS-16I+3.5 | ATS-16I+2.5 | ATS-16I | ATS-16I+0.5 | ATS-16I-0.5 | ATS-16I-1.5 |
| 22 | 1/2 | EX-RH or IN-LH                         | ATS-22E+4.5   | ATS-22E+3.5 | ATS-22E+2.5 | ATS-22E | ATS-22E+0.5 | ATS-22E-0.5 | ATS-22E-1.5 |
| 22 | 1/2 | EX-LH or IN-RH                         | ATS-22I+4.5   | ATS-22I+3.5 | ATS-22I+2.5 | ATS-22I | ATS-22I+0.5 | ATS-22I-0.5 | ATS-22I-1.5 |
| 27 | 5/8 | EX-RH or IN-LH                         | ATS-27E+4.5   | ATS-27E+3.5 | ATS-27E+2.5 | ATS-27E | ATS-27E+0.5 | ATS-27E-0.5 | ATS-27E-1.5 |
| 27 | 5/8 | EX-LH or IN-RH                         | ATS-27I+4.5   | ATS-27I+3.5 | ATS-27I+2.5 | ATS-27I | ATS-27I+0.5 | ATS-27I-0.5 | ATS-27I-1.5 |

## Altlık Değişirme Öneri Tablosu / Shim Change Recommendation Empfehlungen zum Wechseln der Unterlage

Tabloda da görüldüğü gibi bazı diş hatvelerinin çaplara göre kombinasyonları altlık değişimini gerektirir. Eğer değişim gerekli ise EX-RH ve IN-LH katerleri için ATS-E altlıklarını, IN-RH ve EX-LH katerleri için ATS-I altlıklarını kullanın.  
 As can be seen from the chart, some Pitch to Diameter combinations require a shim change. If change is required, use ATS-E shim for EX-RH and IN-LH toolholders and ATS-I shims for IN-RH and EX-LH toolholders.

Wie aus der Tabelle ersichtlich, erfordern einige Steigung-Durchmesser-Kombinationen einen Wechsel der Unterlage. In diesem Fall wird eine ATS-E-Unterlage auf einem rechten Außenhalter bzw. einem linken Innenhalter eingesetzt. Die ATS-I-Unterlage kommt bei einem rechten Innenhalter bzw. einem linken Außenhalter zum Einsatz.

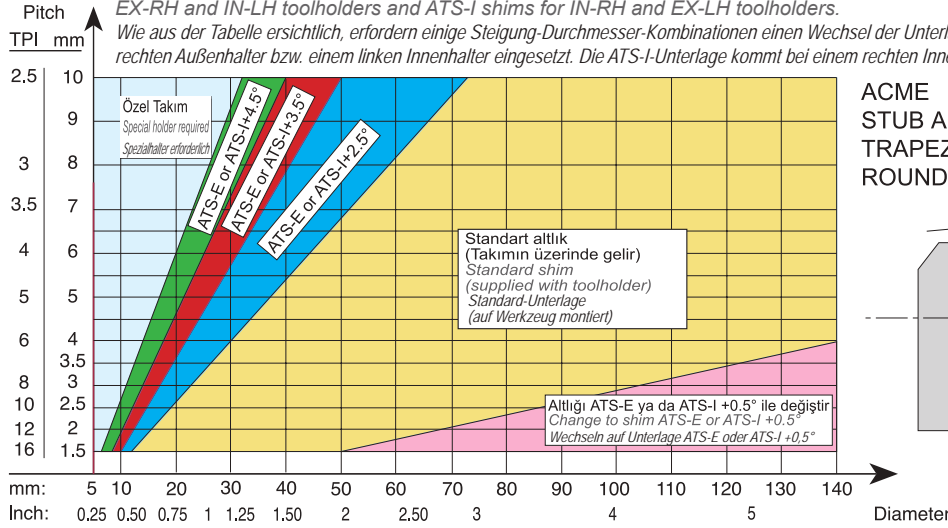

ACME  
 STUB ACME  
 TRAPEZ (DIN 103)  
 ROUND (DIN 405)

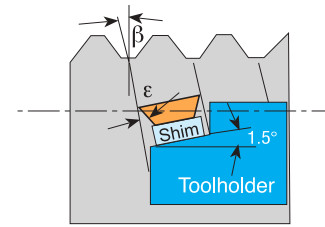

Tabloda da görüldüğü gibi çoğu uygulamalar altlık değişimine ihtiyaç duymaz. Eğer değişime ihtiyaç duyulursa EX-RH ve IN-LH katerleri için ATS-E altlıklarını, IN-RH ve EX-RH katerleri için ATS-I altlıklarını kullanın.

As can be seen from the chart, most applications do not require a shim change. If change is required, use ATS-E shims for EX-RH and IN-LH toolholders and ATS-I shims for IN-RH and EX-LH toolholders.

Wie aus der Tabelle ersichtlich, erfordern einige Steigung-Durchmesser-Kombinationen einen Wechsel der Unterlage. In diesem Fall wird eine ATS-E-Unterlage auf einem rechten Außenhalter bzw. einem linken Innenhalter eingesetzt. Die ATS-I-Unterlage kommt bei einem rechten Innenhalter bzw. einem linken Außenhalter zum Einsatz.

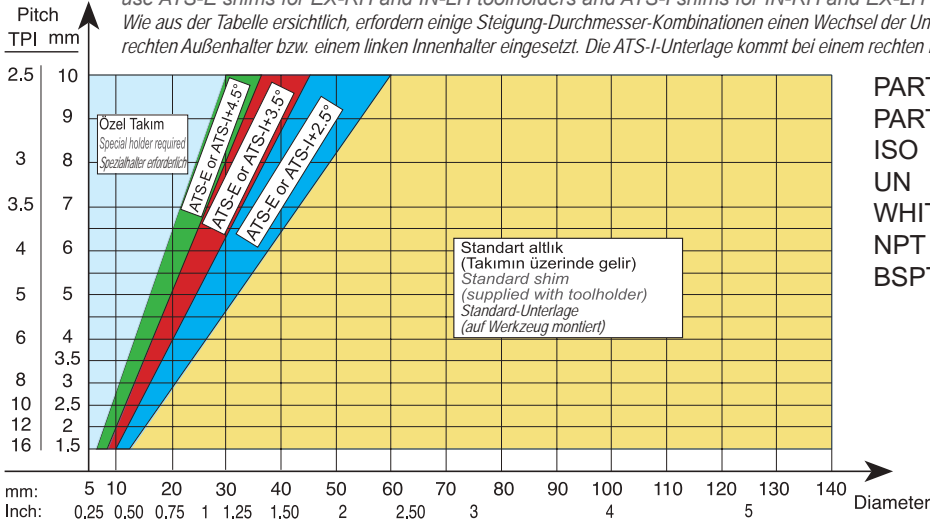

PARTIAL PROFILES 60°  
 PARTIAL PROFILES 55°  
 ISO  
 UN  
 WHIT.  
 NPT  
 BSPT

Tabloda da görüldüğü gibi çoğu uygulamalar altlık değişimine ihtiyaç duyar. Çoğu durumda negatif bir altlığı ihtiyaç duyulur. EX-RH ve IN-LH takımlar için ATS-E altlıklarını kullanın. IN-RH ve EX-LH takımlar için ATS-I altlıklarını kullanın.

As can be seen from the chart, most applications require a shim change. In most cases a negative shim is required, use ATS-E shims for EX-RH and IN-LH toolholders. ATS-I shims for IN-RH and EX-LH toolholders.

Wie aus der Tabelle ersichtlich, erfordern einige Steigung-Durchmesser-Kombinationen einen Wechsel der Unterlage. In diesem Fall wird eine ATS-E-Unterlage auf einem rechten Außenhalter bzw. einem linken Innenhalter eingesetzt. Die ATS-I-Unterlage kommt bei einem rechten Innenhalter bzw. einem linken Außenhalter zum Einsatz.

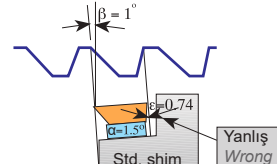
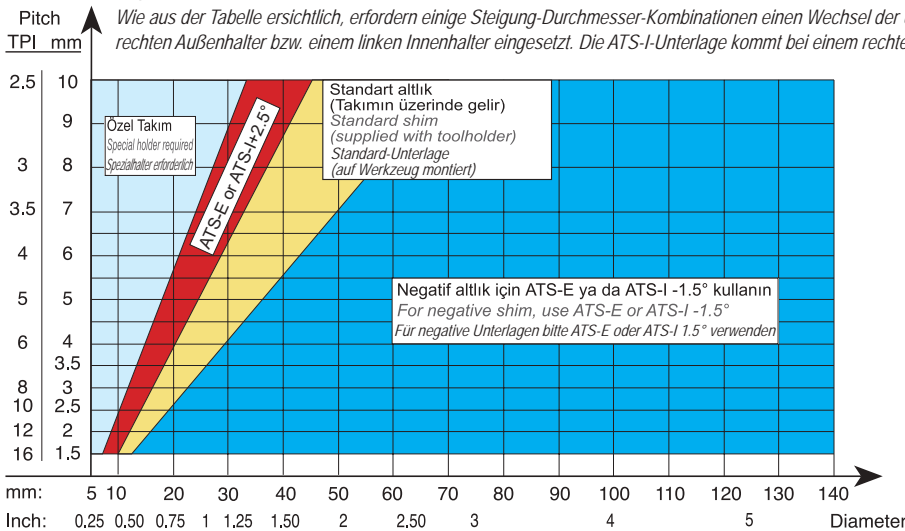

Before Shim Change  
 Altlığı Değiştirmeden Önce  
 До смены опорной пластины

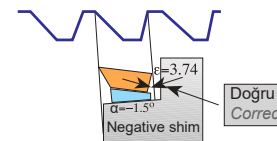

After Shim Change  
 Altlığı Değiştirdikten Sonra  
 Nach dem Wechsel der Unterlegplatte

AMERICAN  
 BUTTRESS  
 SAGENGEWINDE  
 (DIN 513)

Standart altlığın negatif bir altlıkla değiştirilmesi, kenar sürtmesini engelleyecektir.

Replacing the standard shim with a shim has negative angle, will eliminate side rubbing

Das Ersetzen der Standard-Unterlegplatte durch eine Unterlegplatte mit negativem Winkel verhindert seitliche Reibung.



*konusulan  
the spoken kalite...  
quality...*

# KANAL AÇMA

KANAL AÇMA TAKIMLARI  
GROOVING TOOLHOLDERS  
STECHHALTER



AKKO **A** **AKT** - **K** - **R** - **2525**

**100 - 150** - **4** - **T22**

**2** Kesici Stili / Cutter Style / Cutter-Stil

DKT: Dış Çap Kanal Açma Takımı / External Grooving Toolholders  
Außen-Steckhalter  
IKT: Delik İçi Kanal Açma Takımı / Internal Grooving Toolholders  
Innen-Steckhalter  
AKT: Dış Çap Alın Kanal Takımları / Face Grooving Toolholders  
Axial-Steckhalter  
LKT: L Tip Alın Kanal Açma Takımı / L Type Face Grooving Toolholders  
Axial-Steckhalter L-Type

**3** Uç Tipi / Insert Type / Plattenform

KRLY / MGM.  
HRN / S312, S229, S224, S223  
ISCR / DGN, GI, GTN  
SNDVK / 123, 151, 154.91  
ZCC  
KM / A4.  
ARN / LOMR.

TGTC / TD.

**4** Kesme Yönü / Cutting Direction  
Halteausführung

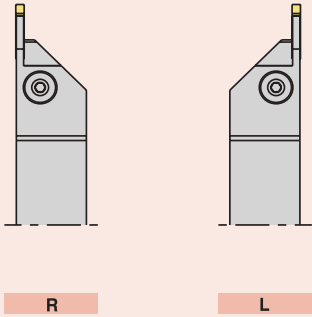

**5** Kesme Kenar Yüksekliği ve Şaft Geniřlięi  
Cutting Edge Height and Shank Width  
Schafthöhe und Schafbreite

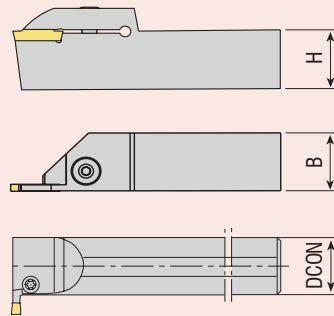

**6** Kesme Aralıęı  
Cutting Diameter  
Durchmesser für Axialeinstechen

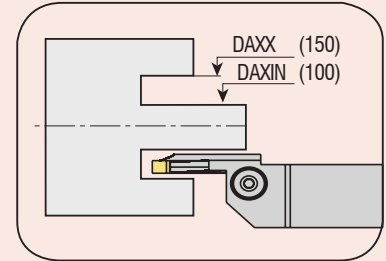

**7** Kesme Kenar Geniřlięi / Cutting Width Edge  
Plattenbreite

ÖR/E.G. :  
2 = 2.0 mm  
3 = 3.0 mm  
4 = 4.0 mm  
5 = 5.0 mm  
6 = 6.0 mm  
8 = 8.0 mm

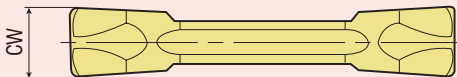

**8** Kesme Derinlięi / Cutting Depth / Maximale Schnitttiefe

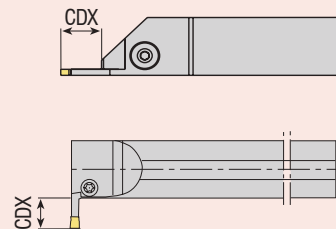

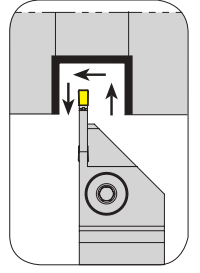
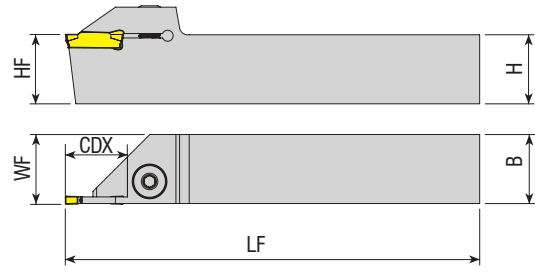

| Takım Kodu<br>Ordering Code<br>Bestell-Bezeichnung | Stok<br>Stock<br>Lager |   | Takım Ölçüleri (mm)<br>Dimension (mm)<br>Abmessung (mm) |    |     |      | Kesici Uç<br>Insert<br>Wendeschneidplatte | Yedek Parçaları / Spare Parts / Ersatzteile |  |                      |   |
|--|------------------------|---|---|----|-----|------|---|---|--|----------------------|---|
|  | R                      | L | HF=H  | B  | LF  | WF   |   | CDX   | Sıkma Vidası<br>Screw<br>Klemmschraube | Pul<br>Stamp<br>Ring | Anahtar<br>Allen Key<br>Innensechskantschlüssel |
| ADKT-K-R/L-1212-1.5-T15                            | ●                      | ● | 12  | 12 | 100 | 12.2 | 15  | MGM. - 1.5                                  | AKV-02-M6x22                           | ABPL-01              | AAL-03-3  |
| ADKT-K-R/L-2020-1.5-T15                            | ●                      | ● | 20  | 20 | 125 | 20.2 | 15  |   |  |                      |   |
| ADKT-K-R/L-1212-2-T15                              | ●                      | ● | 12  | 12 | 100 | 16.3 | 15  | MGM. - 2                                    | AKV-02-M6x22                           | ABPL-01              | AAL-03-3  |
| ADKT-K-R/L-1616-2-T10                              | ●                      | ● | 16  | 16 | 125 | 16.3 | 10  |   |  |                      |   |
| ADKT-K-R/L-1616-2-T15                              | ●                      | ● | 16  | 16 | 125 | 16.3 | 15  |   |  |                      |   |
| ADKT-K-R/L-2020-2-T15                              | ●                      | ● | 20  | 20 | 150 | 20.3 | 15  |   |  |                      |   |
| ADKT-K-R/L-2525-2-T15                              | ●                      | ● | 25  | 25 | 150 | 25.3 | 15  |   |  |                      |   |
| ADKT-K-R/L-3232-2-T15                              | ●                      | ● | 32  | 32 | 170 | 32.3 | 15  |   |  |                      |   |
| ADKT-K-R/L-1212-3-T15                              | ●                      | ● | 12  | 12 | 100 | 12.3 | 15  | MGM. - 3                                    | AKV-02-M6x22                           | ABPL-01              | AAL-03-3  |
| ADKT-K-R/L-1616-3-T15                              | ●                      | ● | 16  | 16 | 125 | 16.3 | 15  |   |  |                      |   |
| ADKT-K-R/L-2020-3-T10                              | ●                      | ● | 20  | 20 | 125 | 20.3 | 10  |   |  |                      |   |
| ADKT-K-R/L-2020-3-T20                              | ●                      | ● | 20  | 20 | 125 | 20.3 | 20  |   |  |                      |   |
| ADKT-K-R/L-2020-3-R28                              | ●                      | ● | 20  | 20 | 125 | 20.3 | 28  |   |  |                      |   |
| ADKT-K-R/L-2525-3-T10                              | ●                      | ● | 25  | 25 | 150 | 25.3 | 10  |   |  |                      |   |
| ADKT-K-R/L-2525-3-R15                              | ●                      | ● | 25  | 25 | 150 | 25.3 | 15  |   |  |                      |   |
| ADKT-K-R/L-2525-3-T22                              | ●                      | ● | 25  | 25 | 150 | 25.3 | 22  |   |  |                      |   |
| ADKT-K-R/L-3232-3-T10                              | ●                      | ● | 32  | 32 | 170 | 32.3 | 10  |   |  |                      |   |
| ADKT-K-R/L-3232-3-T22                              | ●                      | ● | 32  | 32 | 170 | 32.3 | 22  |   |  |                      |   |
| ADKT-K-R/L-2020-4-T10                              | ●                      | ● | 20  | 20 | 125 | 20.4 | 10  | MGM. - 4                                    | 2004-M8x1x20                           | -                    | AAL-05-4  |
| ADKT-K-R/L-2020-4-T20                              | ●                      | ● | 20  | 20 | 125 | 20.4 | 20  |   |  |                      |   |
| ADKT-K-R/L-2020-4-R25                              | ●                      | ○ | 20  | 20 | 125 | 20.4 | 25  |   |  |                      |   |
| ADKT-K-R/L-2525-4-T10                              | ●                      | ● | 25  | 25 | 150 | 25.4 | 10  |   |  |                      |   |
| ADKT-K-R/L-2525-4-T18                              | ●                      | ● | 25  | 25 | 150 | 25.4 | 18  |   |  |                      |   |
| ADKT-K-R/L-2525-4-T22                              | ●                      | ● | 25  | 25 | 150 | 25.4 | 22  |   |  |                      |   |
| ADKT-K-R/L-3232-4-T10                              | ●                      | ● | 32  | 32 | 170 | 32.4 | 10  |   |  |                      |   |
| ADKT-K-R/L-3232-4-T22                              | ●                      | ● | 32  | 32 | 170 | 32.4 | 22  |   |  |                      |   |
| ADKT-K-R/L-2020-5-T20                              | ●                      | ● | 20  | 20 | 125 | 20.5 | 20  | MGM. - 5                                    | 2004-M8x1x20                           | -                    | AAL-05-4  |
| ADKT-K-R/L-2525-5-T15                              | ●                      | ● | 25  | 25 | 150 | 25.5 | 15  |   |  |                      |   |
| ADKT-K-R/L-2525-5-T18                              | ●                      | ● | 25  | 25 | 150 | 25.5 | 18  |   |  |                      |   |
| ADKT-K-R/L-2525-5-T25                              | ●                      | ● | 25  | 25 | 150 | 25.5 | 25  |   |  |                      |   |
| ADKT-K-R/L-3232-5-T15                              | ●                      | ● | 32  | 32 | 170 | 32.5 | 15  |   |  |                      |   |
| ADKT-K-R/L-3232-5-T25                              | ●                      | ● | 32  | 32 | 170 | 32.5 | 25  | MGM. - 6                                    | 2004-M8x1x20                           | -                    | AAL-05-4  |
| ADKT-K-R/L-2525-6-T15                              | ●                      | ● | 25  | 25 | 150 | 25.6 | 15  |   |  |                      |   |
| ADKT-K-R/L-2525-6-T25                              | ●                      | ● | 25  | 25 | 150 | 25.6 | 25  |   |  |                      |   |
| ADKT-K-R/L-3232-6-T25                              | ●                      | ● | 32  | 32 | 170 | 32.6 | 25  | MGM. - 8                                    | 2004-M8x1x20                           | -                    | AAL-05-4  |
| ADKT-K-R/L-3232-8-T32                              | ●                      | ● | 32  | 32 | 170 | 32.8 | 32  |   |  |                      |   |

R: Sağ / Right / Rechts L: Sol / Left / Links

● Stokta / In Stock / Auf Lager ○ Stokta Yok / Non Stock Item / Kein Lagerartikel, Lieferzeit auf Anfrage

KRLY - JD Ucuca Uygunudur. / Compatible with KRLY - JD Insert. / Kompatibel mit KRLY - JD Wendeplatten.

Sipariş Örneği/Ordering Example/Bestellbeispiel

1 ad./pcs./stück ADKT-K-R-1212-1.5-T15

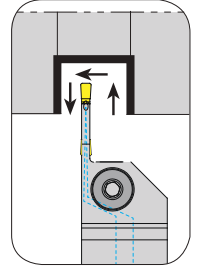
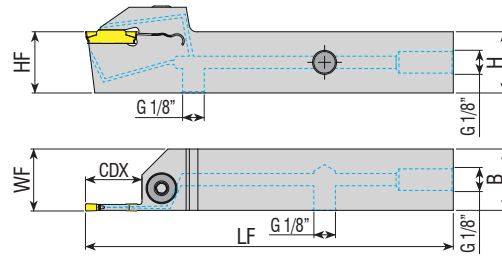

**Takım Kodu**  
**Ordering Code**  
**Bestell-Bezeichnung**

| Stok<br>Stock<br>Lager  | Takım Ölçüleri (mm)<br>Dimension (mm)<br>Abmessung (mm) |   |      |    |     |      | Kesici Uç<br>Insert<br>Wendeschneidplatte | Yedek Parçaları / Spare Parts / Ersatzteile |  |                      |   |
|-------------------------|---|---|------|----|-----|------|---|---|--|----------------------|---|
|                         | R   | L | HF=H | B  | LF  | WF   |   | CDX   | Sıkma Vidası<br>Screw<br>Klemmschraube | Pul<br>Stamp<br>Ring | Anahtar<br>Allen Key<br>Innensechskantschlüssel |
| ADKT-K-R/L-2020-3-T20-H | ●   | ● | 20   | 20 | 125 | 20.4 | 20  | MGM. - 3                                    | 2004-M8x1x20                           | -                    | AAL-05-4  |
| ADKT-K-R/L-2525-3-T22-H | ●   | ● | 25   | 25 | 150 | 25.4 | 22  |   |  |                      |   |
| ADKT-K-R/L-2020-4-T20-H | ●   | ● | 20   | 20 | 125 | 20.4 | 20  | MGM. - 4                                    |  |                      |   |
| ADKT-K-R/L-2525-4-T22-H | ●   | ● | 25   | 25 | 150 | 25.4 | 22  |   |  |                      |   |
| ADKT-K-R/L-2525-5-T25-H | ●   | ● | 25   | 25 | 150 | 25.5 | 25  | MGM. - 5                                    |  |                      |   |

KRRLY Ucuna Uygunur. / Compatible with KRRLY Insert. / Kompatibel mit KRRLY Wendeplatten.

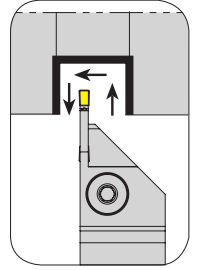
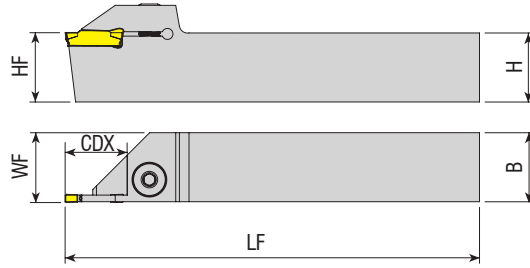
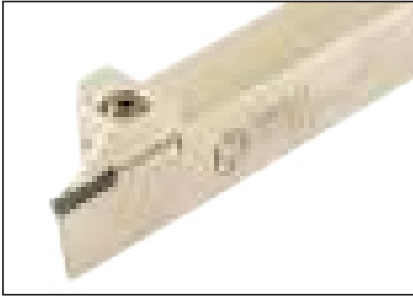

**Takım Kodu**  
**Ordering Code**  
**Bestell-Bezeichnung**

| Stok<br>Stock<br>Lager | Takım Ölçüleri (mm)<br>Dimension (mm)<br>Abmessung (mm) |   |      |    |     |      | Kesici Uç<br>Insert<br>Wendeschneidplatte | Yedek Parçaları / Spare Parts / Ersatzteile |  |                      |   |
|------------------------|---|---|------|----|-----|------|---|---|--|----------------------|---|
|                        | R   | L | HF=H | B  | LF  | WF   |   | CDX   | Sıkma Vidası<br>Screw<br>Klemmschraube | Pul<br>Stamp<br>Ring | Anahtar<br>Allen Key<br>Innensechskantschlüssel |
| ADKT-KG-R/L-2020-2-T15 | ●   | ● | 20   | 20 | 125 | 20.2 | 15  | KG.. - 2                                    | AKV-02-M6x22                           | ABPL-01              | AAL-03-3  |
| ADKT-KG-R/L-2525-2-T8  | ●   | ● | 25   | 25 | 150 | 25.2 | 8   |   |  |                      |   |
| ADKT-KG-R/L-2525-2-T15 | ●   | ○ | 25   | 25 | 150 | 25.2 | 15  |   |  |                      |   |
| ADKT-KG-R/L-2525-2-T17 | ●   | ○ | 25   | 25 | 150 | 25.2 | 17  |   |  |                      |   |
| ADKT-KG-R/L-1616-3-T20 | ●   | ● | 16   | 16 | 125 | 16.3 | 20  | KG.. - 3                                    |  |                      |   |
| ADKT-KG-R/L-2020-3-T20 | ●   | ● | 20   | 20 | 125 | 20.3 | 20  |   |  |                      |   |
| ADKT-KG-R/L-2525-3-T10 | ●   | ● | 25   | 25 | 150 | 25.3 | 10  |   |  |                      |   |
| ADKT-KG-R/L-2525-3-T13 | ●   | ● | 25   | 25 | 150 | 25.3 | 13  | KG.. - 4                                    |  |                      |   |
| ADKT-KG-R/L-2525-3-T22 | ●   | ● | 25   | 25 | 150 | 25.3 | 22  |   |  |                      |   |
| ADKT-KG-R/L-2020-4-T20 | ●   | ● | 20   | 20 | 125 | 20.4 | 20  |   |  |                      |   |
| ADKT-KG-R/L-2525-4-T10 | ●   | ● | 25   | 25 | 150 | 25.4 | 10  | KG.. - 5                                    | 2004-M8x1x20                           | -                    | AAL-05-4  |
| ADKT-KG-R/L-2525-4-T16 | ●   | ○ | 25   | 25 | 150 | 25.4 | 16  |   |  |                      |   |
| ADKT-KG-R/L-2525-4-T22 | ●   | ○ | 25   | 25 | 150 | 25.4 | 22  |   |  |                      |   |
| ADKT-KG-R/L-2525-5-T12 | ●   | ● | 25   | 25 | 150 | 25.5 | 12  | KG.. - 6                                    |  |                      |   |
| ADKT-KG-R/L-2525-5-T15 | ●   | ● | 25   | 25 | 150 | 25.5 | 15  |   |  |                      |   |
| ADKT-KG-R/L-2525-5-T25 | ●   | ○ | 25   | 25 | 150 | 25.5 | 25  |   |  |                      |   |
| ADKT-KG-R/L-2525-6-T25 | ○   | ○ | 25   | 25 | 150 | 25.6 | 25  |   |  |                      |   |

R: Sağ / Right / Rechts L: Sol / Left / Links

● Stokta / In Stock / Auf Lager ○ Stokta Yok / Non Stock Item / Kein Lagerartikel, Lieferzeit auf Anfrage  
KRRLY Ucuna Uygunur. / Compatible with KRRLY Insert. / Kompatibel mit KRRLY Wendeplatten.

Sipariş Örneği/Ordering Example/Bestellbeispiel

1 ad./pcs./stück ADKT-K-R-2020-3-T20-H

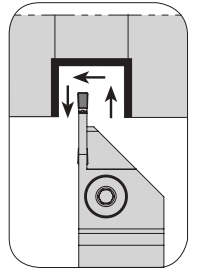
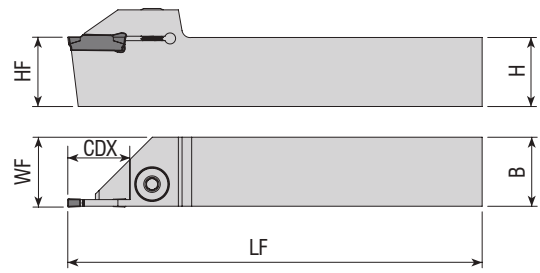
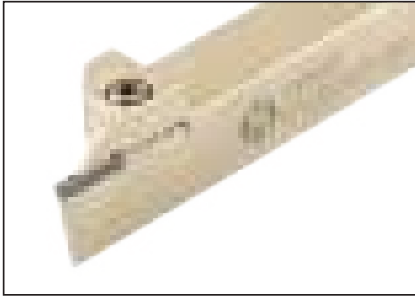

| Takım Kodu<br>Ordering Code<br>Bestell-Bezeichnung | Stok<br>Stock<br>Lager |   | Takım Ölçüleri (mm)<br>Dimension (mm)<br>Abmessung (mm) |    |     |      |     | Kesici Uç<br>Insert<br>Wendeschneidplatte | Yedek Parçaları / Spare Parts / Ersatzteile |                      |   |  |
|--|------------------------|---|---|----|-----|------|-----|---|---|----------------------|---|--|
|  | R                      | L | HF=H  | B  | LF  | WF   | CDX |   | Sıkma Vidası<br>Screw<br>Klemmschraube      | Pul<br>Stamp<br>Ring | Anahtar<br>Allen Key<br>Innensechskantschlüssel |  |
| ADKT-SGC-R/L-1212-2-R15                            | ●                      | ● | 12  | 12 | 100 | 16.2 | 15  | GCM N20                                   | AKV-02-M6x22                                | ABPL-01              | AAL-03-3  |  |
| ADKT-SGC-R/L-1616-2-R15                            | ●                      | ● | 16  | 16 | 125 | 16.2 | 15  |   |   |                      |   |  |
| ADKT-SGC-R/L-2020-2-R20                            | ●                      | ● | 20  | 20 | 125 | 20.2 | 20  |   |   |                      |   |  |
| ADKT-SGC-R/L-2525-2-R20                            | ●                      | ● | 25  | 25 | 150 | 25.2 | 20  | GCM N30                                   | 2004-M8x1x20                                | -                    | AAL-05-4  |  |
| ADKT-SGC-R/L-1212-3-R15                            | ●                      | ● | 12  | 12 | 100 | 16.3 | 15  |   |   |                      |   |  |
| ADKT-SGC-R/L-1616-3-T12                            | ●                      | ○ | 16  | 16 | 125 | 16.3 | 12  |   |   |                      |   |  |
| ADKT-SGC-R/L-1616-3-R15                            | ●                      | ● | 16  | 16 | 125 | 16.3 | 15  | GCM N40                                   | 2004-M8x1x20                                | -                    | AAL-05-4  |  |
| ADKT-SGC-R/L-2020-3-R22                            | ●                      | ● | 20  | 20 | 125 | 20.3 | 22  |   |   |                      |   |  |
| ADKT-SGC-R/L-2525-3-R15                            | ●                      | ○ | 25  | 25 | 150 | 25.3 | 15  |   |   |                      |   |  |
| ADKT-SGC-R/L-2525-3-R22                            | ●                      | ● | 25  | 25 | 150 | 25.3 | 22  | GCM N40                                   | 2004-M8x1x20                                | -                    | AAL-05-4  |  |
| ADKT-SGC-R/L-2525-4-R25                            | ●                      | ○ | 25  | 25 | 150 | 25.4 | 25  |   |   |                      |   |  |

SMTM Ucuna Uygun. / Compatible with SMTM Insert. / Kompatibel mit SMTM

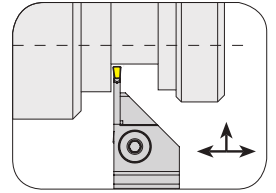
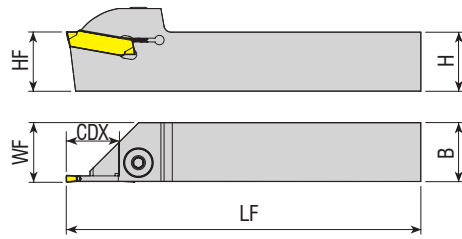
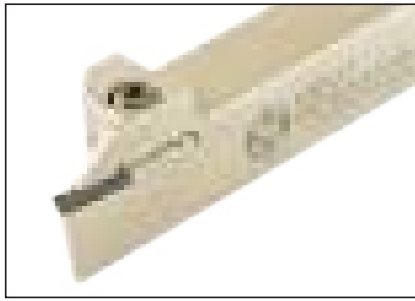

| Takım Kodu<br>Ordering Code<br>Bestell-Bezeichnung | Stok<br>Stock<br>Lager |   | Takım Ölçüleri (mm)<br>Dimension (mm)<br>Abmessung (mm) |    |     |      |     | Kesici Uç<br>Insert<br>Wendeschneidplatte | Yedek Parçaları / Spare Parts / Ersatzteile |                      |   |  |
|--|------------------------|---|---|----|-----|------|-----|---|---|----------------------|---|--|
|  | R                      | L | HF=H  | B  | LF  | WF   | CDX |   | Sıkma Vidası<br>Screw<br>Klemmschraube      | Pul<br>Stamp<br>Ring | Anahtar<br>Allen Key<br>Innensechskantschlüssel |  |
| ADKT-H-R/L-2020-3-T20                              | ●                      | ● | 20  | 20 | 125 | 20.5 | 20  | S229 - 3                                  | 2004-M8x1x20                                | -                    | AAL-05-4  |  |
| ADKT-H-R/L-2525-3-T22                              | ●                      | ● | 25  | 25 | 150 | 25.5 | 22  |   |   |                      |   |  |
| ADKT-H-R/L-2525-3-T26                              | ●                      | ● | 25  | 25 | 150 | 25.5 | 26  |   |   |                      |   |  |
| ADKT-H-R/L-2020-4-T20                              | ●                      | ● | 20  | 20 | 125 | 20.5 | 20  | S229 - 4                                  | 2004-M8x1x20                                | -                    | AAL-05-4  |  |
| ADKT-H-R/L-2525-4-T22                              | ●                      | ● | 25  | 25 | 150 | 25.5 | 22  |   |   |                      |   |  |
| ADKT-H-R/L-3232-4-T22                              | ●                      | ● | 32  | 32 | 170 | 32.5 | 22  |   |   |                      |   |  |
| ADKT-H-R/L-2020-5-T20                              | ●                      | ● | 20  | 20 | 125 | 20.5 | 20  | S229 - 5                                  | 2004-M8x1x20                                | -                    | AAL-05-4  |  |
| ADKT-H-R/L-2525-5-T25                              | ●                      | ● | 25  | 25 | 150 | 25.5 | 25  |   |   |                      |   |  |
| ADKT-H-R/L-2525-6-T25                              | ●                      | ● | 25  | 25 | 150 | 25.6 | 25  | S229 - 6                                  | 2004-M8x1x20                                | -                    | AAL-05-4  |  |

R: Sağ / Right / Rechts L: Sol / Left / Links

● Stokta / In Stock / Auf Lager ○ Stokta Yok / Non Stock Item / Kein Lagerartikel, Lieferzeit auf Anfrage  
HRN Ucuna Uygun. / Compatible with HRN Insert. / Kompatibel mit HRN Wendeplatten.

Sipariş Örneği/Ordering Example/Bestellbeispiel  
1 ad./pcs./stück ADKT-SGC-R-1212-2-R15



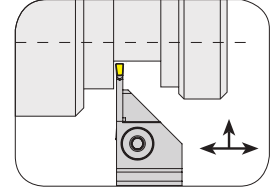
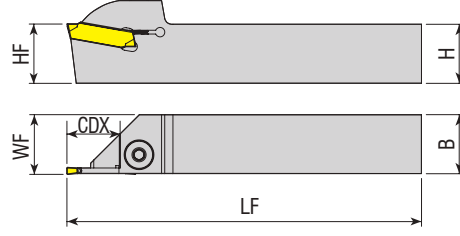
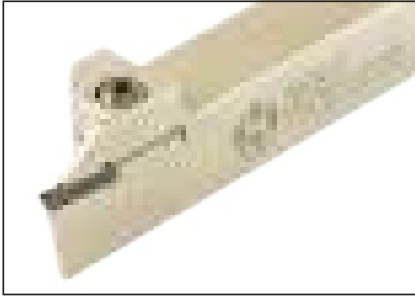

**Takım Kodu**  
**Ordering Code**  
**Bestell-Bezeichnung**

| Takım Kodu<br>Ordering Code<br>Bestell-Bezeichnung | Stok<br>Stock<br>Lager |   | Takım Ölçüleri (mm)<br>Dimension (mm)<br>Abmessung (mm) |    |     |      | Kesici Uç<br>Insert<br>Wendeschneidplatte | Yedek Parçaları / Spare Parts / Ersatzteile |  |                      |   |
|--|------------------------|---|---|----|-----|------|---|---|--|----------------------|---|
|  | R                      | L | HF=H  | B  | LF  | WF   |   | CDX   | Sıkma Vidası<br>Screw<br>Klemmschraube | Pul<br>Stamp<br>Ring | Anahtar<br>Allen Key<br>Innensechskantschlüssel |
| ADKT-HK-R/L-1616-2-T15                             | ●                      | ● | 16  | 16 | 125 | 16.3 | 15  | S224 - 2                                    | AKV-02-M6x22                           | ABPL-01              | AAL-03-3  |
| ADKT-HK-R/L-2020-2-T15                             | ●                      | ● | 20  | 20 | 125 | 20.3 | 15  |   |  |                      |   |
| ADKT-HK-R/L-2525-2-T15                             | ●                      | ● | 25  | 25 | 150 | 25.3 | 15  |   |  |                      |   |
| ADKT-HK-R/L-1616-3-T15                             | ○                      | ○ | 16  | 16 | 125 | 16.3 | 15  | S224 - 3                                    | 2004-M8x1x20                           | -                    | AAL-05-4  |
| ADKT-HK-R/L-2020-3-T20                             | ●                      | ● | 20  | 20 | 125 | 20.4 | 20  |   |  |                      |   |
| ADKT-HK-R/L-2525-3-T22                             | ●                      | ● | 25  | 25 | 150 | 25.4 | 22  |   |  |                      |   |
| ADKT-HK-R/L-2020-4-T20                             | ●                      | ● | 20  | 20 | 125 | 20.4 | 20  |   |  |                      |   |
| ADKT-HK-R/L-2525-4-T22                             | ●                      | ● | 25  | 25 | 150 | 25.4 | 22  | S223 - 2                                    | AKV-02-M6x22                           | ABPL-01              | AAL-03-3  |
| ADKT-HS223-R/L-2020-2-T15                          | ●                      | ○ | 20  | 20 | 125 | 20.4 | 15  |   |  |                      |   |
| ADKT-HS223-R/L-2020-3-T17                          | ●                      | ○ | 20  | 20 | 125 | 20.3 | 17  | S223 - 3                                    | 2004-M8x1x20                           | -                    | AAL-05-4  |

HRN Ucuna Uygundur. / Compatible with HRN Insert. / Kompatibel mit HRN Wendeplatten.

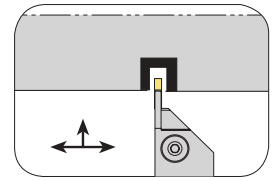
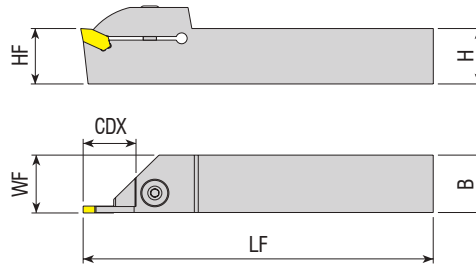
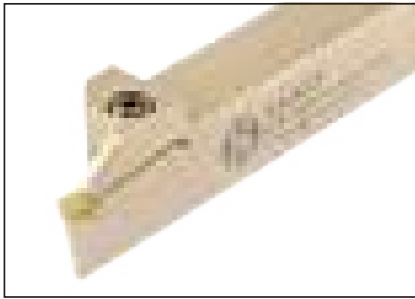

**Takım Kodu**  
**Ordering Code**  
**Bestell-Bezeichnung**

| Takım Kodu<br>Ordering Code<br>Bestell-Bezeichnung | Stok<br>Stock<br>Lager |   | Takım Ölçüleri (mm)<br>Dimension (mm)<br>Abmessung (mm) |    |     |      | Kesici Uç<br>Insert<br>Wendeschneidplatte | Yedek Parçaları / Spare Parts / Ersatzteile |  |                      |   |
|--|------------------------|---|---|----|-----|------|---|---|--|----------------------|---|
|  | R                      | L | HF=H  | B  | LF  | WF   |   | CDX   | Sıkma Vidası<br>Screw<br>Klemmschraube | Pul<br>Stamp<br>Ring | Anahtar<br>Allen Key<br>Innensechskantschlüssel |
| ADKT-ZCC1-R/L-2020-3-T20                           | ●                      | ○ | 20  | 20 | 125 | 20.3 | 20  | ZQMX - 3                                    | 2004-M8x1x20                           | -                    | AAL-05-4  |
| ADKT-ZCC1-R/L-2525-3-T22                           | ●                      | ○ | 25  | 25 | 150 | 25.3 | 22  |   |  |                      |   |
| ADKT-ZCC1-R/L-2020-4-T20                           | ●                      | ○ | 20  | 20 | 125 | 20.4 | 20  | ZQMX - 4                                    | 2004-M8x1x20                           | -                    | AAL-05-4  |
| ADKT-ZCC1-R/L-2525-4-T22                           | ●                      | ○ | 25  | 25 | 150 | 25.4 | 22  |   |  |                      |   |

R: Sağ / Right / Rechts L: Sol / Left / Links  
● Stokta / In Stock / Auf Lager ○ Stokta Yok / Non Stock Item / Kein Lagerartikel, Lieferzeit auf Anfrage  
ZCC Ucuna Uygundur. / Compatible with ZCC Insert. / Kompatibel mit ZCC Wendeplatten.

Sipariş Örneği/Ordering Example/Bestellbeispiel  
1 ad./pcs./stück ADKT-HK-R-1616-2-T15

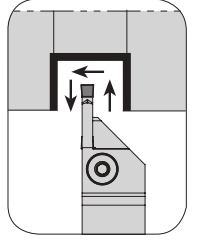
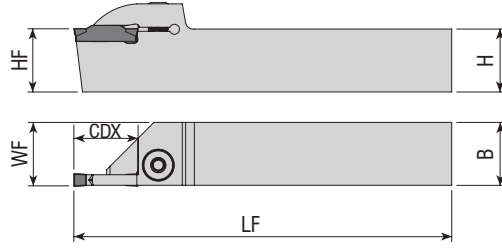

| Takım Kodu<br>Ordering Code<br>Bestell-Bezeichnung | Stok<br>Stock<br>Lager |   | Takım Ölçüleri (mm)<br>Dimension (mm)<br>Abmessung (mm) |    |     |      |     | Kesici Uç<br>Insert<br>Wendeschneidplatte | Yedek Parçaları / Spare Parts / Ersatzteile |                      |   |
|--|------------------------|---|---|----|-----|------|-----|---|---|----------------------|---|
|  | R                      | L | HF=H  | B  | LF  | WF   | CDX |   | Sıkma Vidası<br>Screw<br>Klemmschraube      | Pul<br>Stamp<br>Ring | Anahtar<br>Allen Key<br>Innensechskantschlüssel |
| ADKT-ZCC2-R/L-1616-2-T15                           | ●                      | ● | 16  | 16 | 125 | 16.2 | 15  | Z.BD - 2                                  | AKV-02-M6x22                                | ABPL-01              | AAL-03-3  |
| ADKT-ZCC2-R/L-2020-2-T7                            | ●                      | ● | 20  | 20 | 125 | 20.2 | 7   |   |   |                      |   |
| ADKT-ZCC2-R/L-2020-2-T15                           | ●                      | ● | 20  | 20 | 125 | 20.2 | 15  |   |   |                      |   |
| ADKT-ZCC2-R/L-2525-2-T15                           | ●                      | ● | 25  | 25 | 150 | 25.2 | 15  | Z.ED - 2.5                                | 2004-M8x1x20                                | -                    | AAL-05-4  |
| ADKT-ZCC2-R/L-1616-2.5-T15                         | ●                      | ● | 16  | 16 | 125 | 16.3 | 15  |   |   |                      |   |
| ADKT-ZCC2-R/L-2020-2.5-T17                         | ●                      | ● | 20  | 20 | 125 | 20.3 | 17  |   |   |                      |   |
| ADKT-ZCC2-R/L-2525-2.5-T15                         | ●                      | ● | 25  | 25 | 150 | 25.3 | 15  | Z.FD - 3                                  | 2004-M8x1x20                                | -                    | AAL-05-4  |
| ADKT-ZCC2-R/L-1616-3-T15                           | ●                      | ● | 16  | 16 | 125 | 16.3 | 15  |   |   |                      |   |
| ADKT-ZCC2-R/L-1616-3-T17                           | ●                      | ○ | 16  | 16 | 125 | 16.3 | 17  |   |   |                      |   |
| ADKT-ZCC2-R/L-1616-3-T20                           | ●                      | ○ | 16  | 16 | 125 | 16.3 | 20  | Z.GD - 4                                  | 2004-M8x1x20                                | -                    | AAL-05-4  |
| ADKT-ZCC2-R/L-2020-3-T12                           | ●                      | ● | 20  | 20 | 125 | 20.3 | 12  |   |   |                      |   |
| ADKT-ZCC2-R/L-2020-3-T20                           | ●                      | ● | 20  | 20 | 125 | 20.3 | 20  |   |   |                      |   |
| ADKT-ZCC2-R/L-2020-3-R21                           | ●                      | ○ | 20  | 20 | 125 | 20.3 | 21  | Z.HD - 5                                  | 2004-M8x1x20                                | -                    | AAL-05-4  |
| ADKT-ZCC2-R/L-2020-3-R25                           | ●                      | ● | 20  | 20 | 125 | 20.3 | 25  |   |   |                      |   |
| ADKT-ZCC2-R/L-2525-3-T12                           | ●                      | ○ | 25  | 25 | 150 | 25.3 | 12  |   |   |                      |   |
| ADKT-ZCC2-R/L-2525-3-T22                           | ●                      | ● | 25  | 25 | 150 | 25.3 | 22  | Z.KD - 6                                  | 2004-M8x1x20                                | -                    | AAL-05-4  |
| ADKT-ZCC2-R/L-2525-3-R30                           | ●                      | ● | 25  | 25 | 150 | 25.3 | 30  |   |   |                      |   |
| ADKT-ZCC2-R/L-2020-4-T12                           | ●                      | ○ | 20  | 20 | 125 | 20.5 | 12  |   |   |                      |   |
| ADKT-ZCC2-R/L-2020-4-T20                           | ●                      | ● | 20  | 20 | 125 | 20.5 | 20  | Z.HD - 5                                  | 2004-M8x1x20                                | -                    | AAL-05-4  |
| ADKT-ZCC2-R/L-2525-4-T12                           | ●                      | ● | 25  | 25 | 150 | 25.5 | 12  |   |   |                      |   |
| ADKT-ZCC2-R/L-2525-4-T22                           | ●                      | ● | 25  | 25 | 150 | 25.5 | 22  |   |   |                      |   |
| ADKT-ZCC2-R/L-2020-5-T12                           | ●                      | ○ | 20  | 20 | 125 | 20.5 | 12  | Z.KD - 6                                  | 2004-M8x1x20                                | -                    | AAL-05-4  |
| ADKT-ZCC2-R/L-2020-5-T20                           | ●                      | ● | 20  | 20 | 125 | 20.5 | 20  |   |   |                      |   |
| ADKT-ZCC2-R/L-2525-5-T12                           | ●                      | ○ | 25  | 25 | 150 | 25.5 | 12  |   |   |                      |   |
| ADKT-ZCC2-R/L-2525-5-T25                           | ●                      | ● | 25  | 25 | 150 | 25.5 | 25  | Z.KD - 6                                  | 2004-M8x1x20                                | -                    | AAL-05-4  |
| ADKT-ZCC2-R/L-3232-5-T25                           | ●                      | ● | 32  | 32 | 170 | 32.5 | 25  |   |   |                      |   |
| ADKT-ZCC2-R/L-2020-6-T20                           | ●                      | ● | 20  | 20 | 125 | 20.6 | 20  |   |   |                      |   |
| ADKT-ZCC2-R/L-2525-6-T25                           | ●                      | ● | 25  | 25 | 150 | 25.6 | 25  | Z.KD - 6                                  | 2004-M8x1x20                                | -                    | AAL-05-4  |
| ADKT-ZCC2-R/L-3232-6-T25                           | ●                      | ● | 32  | 32 | 170 | 32.6 | 25  |   |   |                      |   |
| ADKT-ZCC2-R/L-3232-6-T30                           | ●                      | ● | 32  | 32 | 170 | 32.6 | 30  |   |   |                      |   |

R: Sağ / Right / Rechts L: Sol / Left / Links

● Stokta / In Stock / Auf Lager ○ Stokta Yok / Non Stock Item / Kein Lagerartikel, Lieferzeit auf Anfrage  
ZCC Ucuna Uygundur. / Compatible with ZCC Insert. / Kompatibel mit ZCC Wendeplatten.

Sipariş Örneği/Ordering Example/Bestellbeispiel  
1 ad./pcs./stück ADKT-ZCC2-R-1616-2-T15

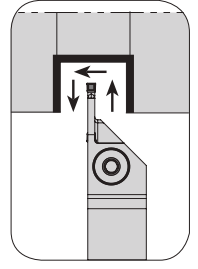
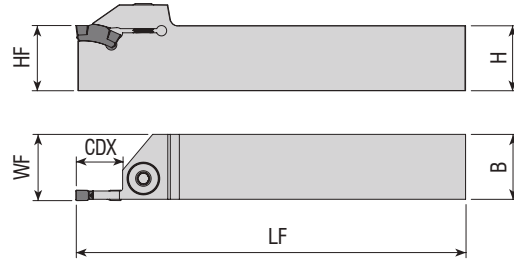

| Takım Kodu<br>Ordering Code<br>Bestell-Bezeichnung | Stok<br>Stock<br>Lager |   | Takım Ölçüleri (mm)<br>Dimension (mm)<br>Abmessung (mm) |    |     |      | Kesici Uç<br>Insert<br>Wendeschneidplatte | Yedek Parçaları / Spare Parts / Ersatzteile |  |                      |   |
|--|------------------------|---|---|----|-----|------|---|---|--|----------------------|---|
|  | R                      | L | HF=H  | B  | LF  | WF   |   | CDX   | Sıkma Vidası<br>Screw<br>Klemmschraube | Pul<br>Stamp<br>Ring | Anahtar<br>Allen Key<br>Innensechskantschlüssel |
| ADKT-ITG-R/L-2020-3-T8                             | ●                      | ● | 20  | 20 | 125 | 20.3 | 8   | TGM. - 3                                    | 2004-M8x1x20                           | -                    | AAL-05-4  |
| ADKT-ITG-R/L-2525-3-T8                             | ●                      | ● | 25  | 25 | 150 | 25.3 | 8   |   |  |                      |   |
| ADKT-ITG-R/L-3232-3-T8                             | ●                      | ○ | 32  | 32 | 170 | 32.3 | 8   |   |  |                      |   |
| ADKT-ITG-R/L-2020-4-T9                             | ●                      | ● | 20  | 20 | 125 | 20.4 | 9   | TGM. - 4                                    | 2004-M8x1x20                           | -                    | AAL-05-4  |
| ADKT-ITG-R/L-2525-4-T17                            | ●                      | ● | 25  | 25 | 150 | 25.4 | 17  |   |  |                      |   |
| ADKT-ITG-R/L-3232-4-T17                            | ●                      | ● | 32  | 32 | 170 | 32.4 | 17  |   |  |                      |   |
| ADKT-ITG-R/L-3232-5-T25                            | ●                      | ○ | 32  | 32 | 170 | 32.5 | 25  | TGM. - 5                                    |  |                      |   |

ISCR Ucuna Uygundur. / Compatible with ISCR Insert. / Kompatibel mit ISCR.

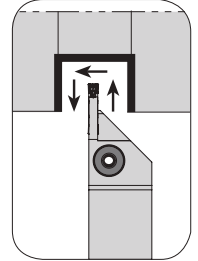
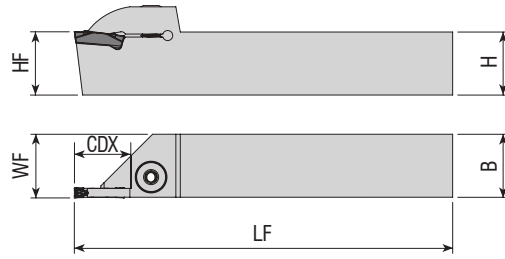
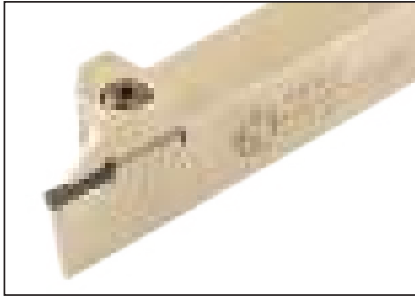

| Takım Kodu<br>Ordering Code<br>Bestell-Bezeichnung | Stok<br>Stock<br>Lager |   | Takım Ölçüleri (mm)<br>Dimension (mm)<br>Abmessung (mm) |    |     |      | Kesici Uç<br>Insert<br>Wendeschneidplatte | Yedek Parçaları / Spare Parts / Ersatzteile |  |                      |   |
|--|------------------------|---|---|----|-----|------|---|---|--|----------------------|---|
|  | R                      | L | HF=H  | B  | LF  | WF   |   | CDX   | Sıkma Vidası<br>Screw<br>Klemmschraube | Pul<br>Stamp<br>Ring | Anahtar<br>Allen Key<br>Innensechskantschlüssel |
| ADKT-KM-R/L-2020-2-T15                             | ●                      | ● | 20  | 20 | 125 | 20.3 | 15  | A4. - 2                                     | AKV-02-M6x22                           | ABPL-01              | AAL-03-3  |
| ADKT-KM-R/L-2525-2-T15                             | ●                      | ● | 25  | 25 | 150 | 25.3 | 15  |   |  |                      |   |
| ADKT-KM-R/L-2020-3-T20                             | ●                      | ● | 20  | 20 | 125 | 20.4 | 20  | A4. - 3                                     | 2004-M8x1x20                           | -                    | AAL-05-4  |
| ADKT-KM-R/L-2525-3-T22                             | ●                      | ● | 25  | 25 | 150 | 25.4 | 22  |   |  |                      |   |
| ADKT-KM-R/L-2525-4-T22                             | ●                      | ● | 25  | 25 | 150 | 25.5 | 22  | A4. - 4                                     |  |                      |   |

R: Sağ / Right / Rechts L: Sol / Left / Links

● Stokta / In Stock / Auf Lager ○ Stokta Yok / Non Stock Item / Kein Lagerartikel, Lieferzeit auf Anfrage

KNMTL Ucuna Uygundur. / Compatible with KNMTL Insert. / Kompatibel mit KNMTL Wendeplatten.

Sipariş Örneği/Ordering Example/Bestellbeispiel

1 ad./pcs./stück ADKT-ITG-R-2020-3-T8

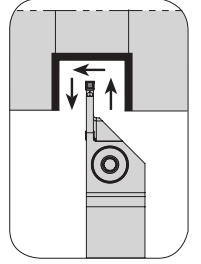
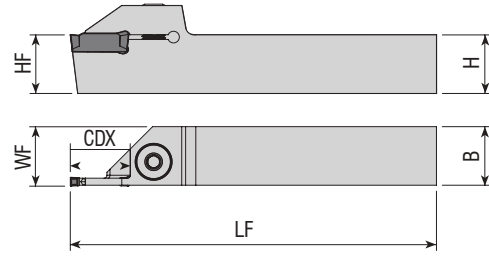

| Takım Kodu<br>Ordering Code<br>Bestell-Bezeichnung | Stok<br>Stock<br>Lager |   | Takım Ölçüleri (mm)<br>Dimension (mm)<br>Abmessung (mm) |    |     |      | Kesici Uç<br>Insert<br>Wendeschneidplatte | Yedek Parçaları / Spare Parts / Ersatzteile |  |                      |   |
|--|------------------------|---|---|----|-----|------|---|---|--|----------------------|---|
|  | R                      | L | HF=H  | B  | LF  | WF   |   | CDX   | Sıkma Vidası<br>Screw<br>Klemmschraube | Pul<br>Stamp<br>Ring | Anahtar<br>Allen Key<br>Innensechskantschlüssel |
| ADKT-I-R/L-1212-2-T15                              | ●                      | ● | 12  | 12 | 125 | 16.3 | 15  | DGN - 2                                     | AKV-02-M6x22                           | ABPL-01              | AAL-03-3  |
| ADKT-I-R/L-1616-2-T15                              | ●                      | ● | 16  | 16 | 100 | 16.3 | 15  |   |  |                      |   |
| ADKT-I-R/L-2020-2-T15                              | ●                      | ● | 20  | 20 | 125 | 20.3 | 15  |   |  |                      |   |
| ADKT-I-R/L-2525-2-T15                              | ●                      | ● | 25  | 25 | 150 | 25.3 | 15  |   |  |                      |   |
| ADKT-I-R/L-3232-2-T15                              | ●                      | ● | 32  | 32 | 170 | 32.3 | 15  | DGN - 3                                     | 2004-M8x1x20                           | -                    | AAL-05-4  |
| ADKT-I-R/L-1212-3-T15                              | ●                      | ● | 12  | 12 | 100 | 16.3 | 15  |   |  |                      |   |
| ADKT-I-R/L-1616-3-T15                              | ●                      | ● | 16  | 16 | 125 | 16.3 | 15  |   |  |                      |   |
| ADKT-I-R/L-2020-3-T12                              | ●                      | ● | 20  | 20 | 125 | 20.3 | 12  |   |  |                      |   |
| ADKT-I-R/L-2020-3-T20                              | ●                      | ● | 20  | 20 | 125 | 20.3 | 20  |   |  |                      |   |
| ADKT-I-R/L-2525-3-T12                              | ●                      | ● | 25  | 25 | 150 | 25.3 | 12  |   |  |                      |   |
| ADKT-I-R/L-2525-3-T22                              | ●                      | ● | 25  | 25 | 150 | 25.3 | 22  |   |  |                      |   |
| ADKT-I-R/L-3232-3-T22                              | ●                      | ● | 32  | 32 | 170 | 32.3 | 22  |   |  |                      |   |
| ADKT-I-R/L-2020-4-T20                              | ●                      | ● | 20  | 20 | 125 | 20.4 | 20  |   |  |                      |   |
| ADKT-I-R/L-2525-4-T12                              | ●                      | ● | 25  | 25 | 150 | 25.4 | 12  |   |  |                      |   |
| ADKT-I-R/L-2525-4-T22                              | ●                      | ● | 25  | 25 | 150 | 25.4 | 22  |   |  |                      |   |
| ADKT-I-R/L-3232-4-T25                              | ●                      | ● | 32  | 32 | 170 | 32.4 | 25  |   |  |                      |   |
| ADKT-I-R/L-2020-5-T20                              | ●                      | ● | 20  | 20 | 125 | 20.5 | 20  | DGN / GRP - 4                               | 2004-M8x1x20                           | -                    | AAL-05-4  |
| ADKT-I-R/L-2525-5-T12                              | ●                      | ● | 25  | 25 | 150 | 25.5 | 12  |   |  |                      |   |
| ADKT-I-R/L-2525-5-T25                              | ●                      | ● | 25  | 25 | 150 | 25.5 | 25  |   |  |                      |   |
| ADKT-I-R/L-2020-5-T25                              | ●                      | ● | 20  | 20 | 125 | 20.5 | 20  |   |  |                      |   |
| ADKT-IG-R/L-1616-3-T18                             | ●                      | ○ | 16  | 16 | 125 | 16.3 | 18  | GRP - 3                                     | AKV-02-M6x22                           | ABPL-01              | AAL-03-3  |
| ADKT-IG-R/L-2020-3-T12                             | ●                      | ● | 20  | 20 | 125 | 20.3 | 12  |   |  |                      |   |
| ADKT-IG-R/L-2020-3-R20                             | ●                      | ● | 20  | 20 | 125 | 20.3 | 20  |   |  |                      |   |
| ADKT-IG-R/L-2525-3-T12                             | ●                      | ● | 25  | 25 | 150 | 25.3 | 12  |   |  |                      |   |
| ADKT-IG-R/L-2525-3-T22                             | ●                      | ● | 25  | 25 | 150 | 25.3 | 22  | GIM / GIP - 2                               | AKV-02-M6x22                           | ABPL-01              | AAL-03-3  |
| ADKT-IGI-R/L-2020-2-T15                            | ●                      | ● | 20  | 20 | 125 | 20.3 | 15  |   |  |                      |   |
| ADKT-IGI-R/L-2525-2-T15                            | ●                      | ● | 25  | 25 | 150 | 25.3 | 15  |   |  |                      |   |
| ADKT-IGI-R/L-1616-3-T15                            | ●                      | ● | 16  | 16 | 125 | 16.3 | 15  |   |  |                      |   |
| ADKT-IGI-R/L-2020-3-T20                            | ●                      | ● | 20  | 20 | 125 | 20.3 | 20  |   |  |                      |   |
| ADKT-IGI-R/L-2525-3-T9                             | ●                      | ● | 25  | 25 | 150 | 25.3 | 9   |   |  |                      |   |
| ADKT-IGI-R/L-2525-3-T22                            | ●                      | ● | 25  | 25 | 150 | 25.3 | 22  |   |  |                      |   |
| ADKT-IGI-R/L-2525-4-T22                            | ●                      | ● | 25  | 25 | 150 | 25.4 | 22  |   |  |                      |   |
| ADKT-IGI-R/L-2525-5-T25                            | ●                      | ● | 25  | 25 | 150 | 25.5 | 25  |   |  |                      |   |
| new ADKT-IGI-R/L-2525-8-T25                        | ●                      | ○ | 25  | 25 | 150 | 25.8 | 25  |   |  |                      |   |
| ADKT-IGI-R/L-2525-8-T30                            | ●                      | ○ | 25  | 25 | 150 | 25.8 | 30  |   |  |                      |   |
| ADKT-IGTN-R/L-2525-5-T25                           | ●                      | ● | 25  | 25 | 150 | 25.6 | 25  |   |  |                      |   |
| new ADKT-IDC-R/L-1616-2-D35                        | ○                      | ● | 16  | 16 | 140 | 16.2 | 35  | DCE - 2                                     | AKV-02-M6x22                           | ABPL-01              | AAL-03-3  |
| new ADKT-IDC-R/L-2020-2-R23                        | ●                      | ○ | 20  | 20 | 125 | 20.2 | 23  |   |  |                      |   |
| new ADKT-IDC-R/L-2525-2-R23                        | ●                      | ○ | 25  | 25 | 150 | 25.2 | 23  | DCE - 3                                     | 2503-M4x19                             | -                    | AAL-05-4  |
| new ADKT-IDC-R/L-1616-3-D35                        | ●                      | ○ | 16  | 16 | 140 | 16.3 | 35  |   |  |                      |   |
| ADKT-IDC-R/L-2525-3-T21                            | ●                      | ○ | 25  | 25 | 150 | 25.4 | 21  | DCE - 3                                     | 2504-M5x18                             | -                    | AAL-05-4  |
|  |                        |   |   |    |     |      |   |   |  |                      |   |

R: Sağ / Right / Rechts L: Sol / Left / Links

● Stokta / In Stock / Auf Lager ○ Stokta Yok / Non Stock Item / Kein Lagerartikel, Lieferzeit auf Anfrage  
ISCR Ucuna Uygundur. / Compatible with ISCR Insert. / Kompatibel mit ISCR Wendeleplatten.

Sipariş Örneği/Ordering Example/Bestellbeispiel

1 ad./pcs./stück ADKT-I-R-1212-2-T15

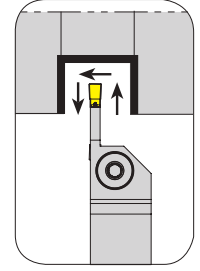
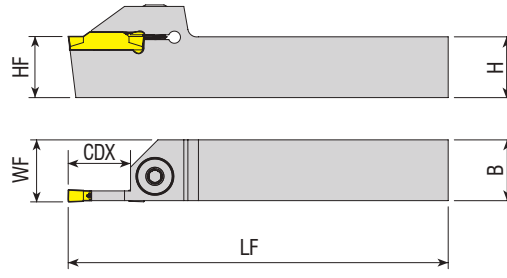
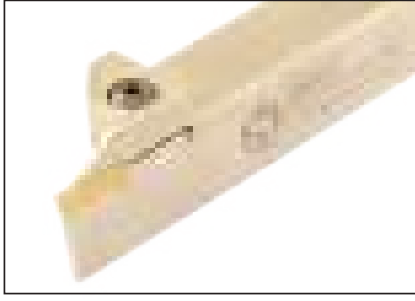

| Takım Kodu<br>Ordering Code<br>Bestell-Bezeichnung | Stok<br>Stock<br>Lager |   | Takım Ölçüleri (mm)<br>Dimension (mm)<br>Abmessung (mm) |    |     |      |     | Kesici Uç<br>Insert<br>Wendescheidplatte | Yedek Parçaları / Spare Parts / Ersatzteile |                      |   |
|--|------------------------|---|---|----|-----|------|-----|--|---|----------------------|---|
|  | R                      | L | HF=H  | B  | LF  | WF   | CDX |  | Sıkma Vidası<br>Screw<br>Klemmschraube      | Pul<br>Stamp<br>Ring | Anahtar<br>Allen Key<br>Innensechskantschlüssel |
| ADKT-123-R/L-1212-1.5-R15                          | ●                      | ● | 12  | 12 | 100 | 12.2 | 15  | 123 - 1.5                                | AKV-02-M6x22                                | ABPL-01              | AAL-03-3  |
| ADKT-123-R/L-1616-1.5-R15                          | ●                      | ● | 16  | 16 | 125 | 16.2 | 15  |  |   |                      |   |
| <b>new</b> ADKT-123-R/L-2012-1.5-R15               | ○                      | ● | 20  | 12 | 125 | 12.5 | 15  |  |   |                      |   |
| ADKT-123-R/L-1616-2-T15                            | ●                      | ○ | 16  | 16 | 125 | 16.2 | 15  | 123 - 2                                  | AKV-02-M6x22                                | ABPL-01              | AAL-03-3  |
| ADKT-123-R/L-2020-2-T8                             | ●                      | ● | 20  | 20 | 125 | 20.2 | 8   |  |   |                      |   |
| ADKT-123-R/L-2020-2-T15                            | ●                      | ● | 20  | 20 | 125 | 20.2 | 15  |  |   |                      |   |
| ADKT-123-R/L-2525-2-T8                             | ●                      | ● | 25  | 25 | 150 | 25.2 | 8   |  |   |                      |   |
| ADKT-123-R/L-2525-2-T15                            | ●                      | ● | 25  | 25 | 150 | 25.2 | 15  |  |   |                      |   |
| ADKT-123-R/L-3232-2-T15                            | ●                      | ● | 32  | 32 | 170 | 32.2 | 15  |  |   |                      |   |
| ADKT-123-R/L-1616-3-T10                            | ●                      | ● | 16  | 16 | 125 | 16.3 | 10  |  |   |                      |   |
| ADKT-123-R/L-1616-3-T15                            | ●                      | ● | 16  | 16 | 125 | 16.3 | 15  |  |   |                      |   |
| ADKT-123-R/L-2020-3-T10                            | ●                      | ● | 20  | 20 | 125 | 20.3 | 10  |  |   |                      |   |
| ADKT-123-R/L-2020-3-T15                            | ●                      | ● | 20  | 20 | 125 | 20.3 | 15  |  |   |                      |   |
| ADKT-123-R/L-2020-3-T20                            | ●                      | ● | 20  | 20 | 125 | 20.3 | 20  |  |   |                      |   |
| ADKT-123-R/L-2525-3-T10                            | ●                      | ● | 25  | 25 | 150 | 25.3 | 10  |  |   |                      |   |
| ADKT-123-R/L-2525-3-T15                            | ●                      | ● | 25  | 25 | 150 | 25.3 | 15  |  |   |                      |   |
| ADKT-123-R/L-2525-3-T22                            | ●                      | ● | 25  | 25 | 150 | 25.3 | 22  | 123 - 4                                  | 2004-M8x1x20                                | -                    | AAL-05-4  |
| ADKT-123-R/L-2020-4-T20                            | ●                      | ● | 20  | 20 | 125 | 20.4 | 20  |  |   |                      |   |
| ADKT-123-R/L-2525-4-T13                            | ●                      | ● | 25  | 25 | 150 | 25.4 | 13  |  |   |                      |   |
| ADKT-123-R/L-2525-4-T22                            | ●                      | ● | 25  | 25 | 150 | 25.4 | 22  |  |   |                      |   |
| ADKT-123-R/L-3232-4-T25                            | ●                      | ● | 32  | 32 | 170 | 32.4 | 25  | 123 - 5                                  | 2004-M8x1x20                                | -                    | AAL-05-4  |
| ADKT-123-R/L-2020-5-T20                            | ●                      | ● | 20  | 20 | 125 | 20.5 | 20  |  |   |                      |   |
| ADKT-123-R/L-2525-5-T25                            | ●                      | ● | 25  | 25 | 150 | 25.5 | 25  |  |   |                      |   |
| ADKT-123-R/L-3232-6-T15                            | ●                      | ● | 32  | 32 | 170 | 32.5 | 15  | 123 - 6                                  | 2004-M8x1x20                                | -                    | AAL-05-4  |

R: Sağ / Right / Rechts L: Sol / Left / Links  
 ● Stokta / In Stock / Auf Lager ○ Stokta Yok / Non Stock Item / Kein Lagerartikel, Lieferzeit auf Anfrage  
 SNDVK Ucuna Uygun. / Compatible with SNDVK Insert. / Kompatibel mit SNDVK Wendeplatten.

Sipariş Örneği/Ordering Example/Bestellbeispiel  
 1 ad./pcs./stück ADKT-123-R-1212-1.5-R15

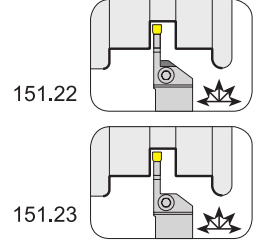
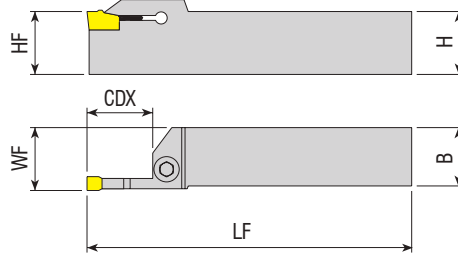
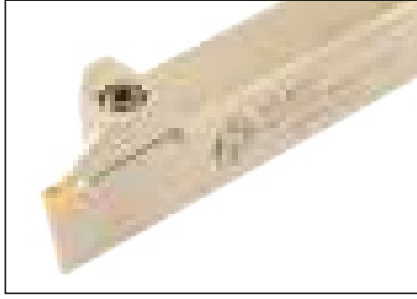

| Takım Kodu<br>Ordering Code<br>Bestell-Bezeichnung | Stok<br>Stock<br>Lager |   | Takım Ölçüleri (mm)<br>Dimension (mm)<br>Abmessung (mm) |    |     |      | Kesici Uç<br>Insert<br>Wendeschneidplatte | Yedek Parçaları / Spare Parts / Ersatzteile |  |                      |   |
|--|------------------------|---|---|----|-----|------|---|---|--|----------------------|---|
|  | R                      | L | HF=H  | B  | LF  | WF   |   | CDX   | Sıkma Vidası<br>Screw<br>Klemmschraube | Pul<br>Stamp<br>Ring | Anahtar<br>Allen Key<br>Innensechskantschlüssel |
| ADKT-151.22-R/L-1616-2-T15                         | ●                      | ● | 16  | 16 | 125 | 16.3 | 15  | 151.2 - 2                                   | AKV-02-M6x22                           | ABPL-01              | AAL-03-3  |
| ADKT-151.22-R/L-2020-2-T15                         | ●                      | ● | 20  | 20 | 125 | 20.3 | 15  |   |  |                      |   |
| ADKT-151.22-R/L-2525-2-T15                         | ●                      | ● | 25  | 25 | 150 | 25.3 | 15  | 151.2 - 3                                   |  |                      |   |
| ADKT-151.22-R/L-1616-3-T15                         | ●                      | ● | 16  | 16 | 125 | 16.4 | 15  |   |  |                      |   |
| ADKT-151.22-R/L-2020-3-T20                         | ●                      | ● | 20  | 20 | 125 | 20.4 | 20  | 151.2 - 4                                   | 2004-M8x1x20                           | -                    | AAL-05-4  |
| ADKT-151.22-R/L-2525-3-T22                         | ●                      | ● | 25  | 25 | 150 | 25.4 | 22  |   |  |                      |   |
| ADKT-151.22-R/L-1616-4-T15                         | ●                      | ● | 16  | 16 | 125 | 16.4 | 15  | 151.2 - 5                                   |  |                      |   |
| ADKT-151.22-R/L-2020-4-T20                         | ●                      | ● | 20  | 20 | 125 | 20.4 | 20  |   |  |                      |   |
| ADKT-151.22-R/L-2525-4-T22                         | ●                      | ● | 25  | 25 | 150 | 25.4 | 22  | 151.2 - 2                                   | AKV-02-M6x22                           | ABPL-01              | AAL-03-3  |
| ADKT-151.22-R/L-2020-5-T20                         | ●                      | ● | 20  | 20 | 125 | 20.5 | 20  |   |  |                      |   |
| ADKT-151.22-R/L-2525-5-T25                         | ●                      | ● | 25  | 25 | 150 | 25.5 | 25  | 151.2 - 2.5                                 |  |                      |   |
| ADKT-151.23-R/L-1616-2-T15                         | ●                      | ● | 16  | 16 | 125 | 16.3 | 15  |   |  |                      |   |
| ADKT-151.23-R/L-2020-2-T15                         | ●                      | ● | 20  | 20 | 125 | 20.3 | 15  | 151.2 - 3                                   | 2004-M8x1x20                           | -                    | AAL-05-4  |
| ADKT-151.23-R/L-2525-2-T15                         | ●                      | ● | 25  | 25 | 150 | 25.3 | 15  |   |  |                      |   |
| ADKT-151.23-R/L-1616-2.5-T15                       | ●                      | ● | 16  | 16 | 125 | 16.3 | 15  | 151.2 - 4                                   |  |                      |   |
| ADKT-151.23-R/L-2020-2.5-T15                       | ●                      | ● | 20  | 20 | 125 | 20.3 | 15  |   |  |                      |   |
| ADKT-151.23-R/L-2525-2.5-T15                       | ●                      | ● | 25  | 25 | 150 | 25.3 | 15  | 151.2 - 5                                   |  |                      |   |
| ADKT-151.23-R/L-1212-3-T15                         | ●                      | ● | 12  | 12 | 100 | 16.4 | 15  |   |  |                      |   |
| ADKT-151.23-R/L-1616-3-T15                         | ●                      | ● | 16  | 16 | 125 | 16.4 | 15  | 151.2 - 3                                   | 2004-M8x1x20                           | -                    | AAL-05-4  |
| ADKT-151.23-R/L-2020-3-T20                         | ●                      | ● | 20  | 20 | 125 | 20.4 | 20  |   |  |                      |   |
| ADKT-151.23-R/L-2525-3-T20                         | ●                      | ● | 25  | 25 | 150 | 25.4 | 20  | 151.2 - 4                                   |  |                      |   |
| ADKT-151.23-R/L-2525-3-T22                         | ●                      | ● | 25  | 25 | 150 | 25.4 | 22  |   |  |                      |   |
| ADKT-151.23-R/L-1616-4-T15                         | ●                      | ● | 16  | 16 | 125 | 16.4 | 15  | 151.2 - 5                                   |  |                      |   |
| ADKT-151.23-R/L-2020-4-T20                         | ●                      | ● | 20  | 20 | 125 | 20.4 | 20  |   |  |                      |   |
| ADKT-151.23-R/L-2525-4-T22                         | ●                      | ● | 25  | 25 | 150 | 25.4 | 22  | 151.2 - 5                                   |  |                      |   |
| ADKT-151.23-R/L-2020-5-T20                         | ●                      | ● | 20  | 20 | 125 | 20.5 | 20  |   |  |                      |   |
| ADKT-151.23-R/L-2525-5-T25                         | ●                      | ● | 25  | 25 | 150 | 25.5 | 25  |   |  |                      |   |

R: Sağ / Right / Rechts L: Sol / Left / Links

● Stokta / In Stock / Auf Lager ○ Stokta Yok / Non Stock Item / Kein Lagerartikel, Lieferzeit auf Anfrage  
SNDVK Ucuna Uygunundur. / Compatible with SNDVK Insert. / Kompatibel mit SNDVK Wendeplatten.

Sipariş Örneği/Ordering Example/Bestellbeispiel  
1 ad./pcs./stück ADKT-151.22-R-1616-2-T15

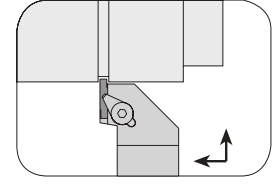
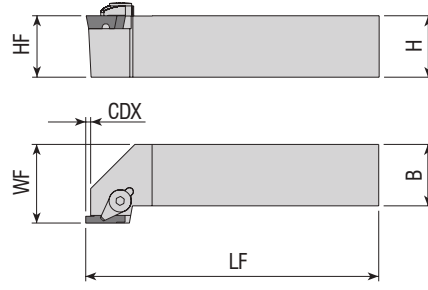

| Takım Kodu<br>Ordering Code<br>Bestell-Bezeichnung | Stok<br>Stock<br>Lager |   | Takım Ölçüleri (mm)<br>Dimension (mm)<br>Abmessung (mm) |    |     |      |     | Kesici Uç<br>Insert<br>Wendeschneidplatte | Yedek Parçaları / Spare Parts / Ersatzteile  |  |                      |   |  |
|--|------------------------|---|---|----|-----|------|-----|---|--|--|----------------------|---|--|
|  | R                      | L | HF=H  | B  | LF  | WF   | CDX |   | Baskı Parçası<br>Wedge Clamp<br>Spannspratze | Sıkma Vidası<br>Screw<br>Klemmschraube | Pul<br>Stamp<br>Ring | Anahtar<br>Allen Key<br>Innensechskantschlüssel |  |
| ADKT-154.91-R/L-2020-3-T4                          | ●                      | ● | 20  | 20 | 125 | 25   | 4   | 154.91 - 3                                | ACK-03                                       | AKV-07-M6x22                           | APM-06               | AAL-03-3  |  |
| ADKT-154.91-R/L-2525-3-T4                          | ●                      | ● | 25  | 25 | 150 | 30.5 | 4   |   |  |  |                      |   |  |
| ADKT-154.91-R/L-2020-5-T5                          | ●                      | ● | 20  | 20 | 125 | 25   | 5   | 154.91 - 5                                | ACK-03                                       | AKV-07-M6x22                           | APM-06               | AAL-03-3  |  |
| ADKT-154.91-R/L-2525-5-T5                          | ●                      | ● | 25  | 25 | 150 | 30.5 | 5   |   |  |  |                      |   |  |

SNDVK Ucuna Uygunur. / Compatible with SNDVK Insert. / Kompatibel mit SNDVK Wendepfatten.

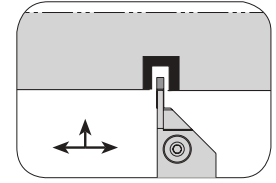
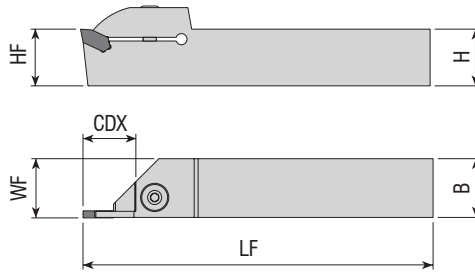

| Takım Kodu<br>Ordering Code<br>Bestell-Bezeichnung | Stok<br>Stock<br>Lager |   | Takım Ölçüleri (mm)<br>Dimension (mm)<br>Abmessung (mm) |    |     |      |     | Kesici Uç<br>Insert<br>Wendeschneidplatte | Yedek Parçaları / Spare Parts / Ersatzteile |                      |   |  |
|--|------------------------|---|---|----|-----|------|-----|---|---|----------------------|---|--|
|  | R                      | L | HF=H  | B  | LF  | WF   | CDX |   | Sıkma Vidası<br>Screw<br>Klemmschraube      | Pul<br>Stamp<br>Ring | Anahtar<br>Allen Key<br>Innensechskantschlüssel |  |
| ADKT-ARN-R/L-2020-2-T15                            | ●                      | ● | 20  | 20 | 125 | 20.3 | 15  | LOMR. - 2                                 | AKV-02-M6x22                                | ABPL-01              | AAL-03-3  |  |
| ADKT-ARN-R/L-2525-2-T15                            | ●                      | ● | 25  | 25 | 150 | 25.3 | 15  |   |   |                      |   |  |
| ADKT-ARN-R/L-2020-3-T20                            | ●                      | ● | 20  | 20 | 125 | 20.4 | 20  | LOMR. - 3                                 | 2004-M8x1x20                                | -                    | AAL-05-4  |  |
| ADKT-ARN-R/L-2525-3-T22                            | ●                      | ● | 25  | 25 | 150 | 25.4 | 22  |   |   |                      |   |  |

R: Sağ / Right / Rechts L: Sol / Left / Links  
● Stokta / In Stock / Auf Lager ○ Stokta Yok / Non Stock Item / Kein Lagerartikel, Lieferzeit auf Anfrage  
ARN Ucuna Uygunur. / Compatible with ARN Insert. / Kompatibel mit ARN Wendepfatten.

Sipariş Örneği/Ordering Example/Bestellbeispiel  
1 ad./pcs./stück ADKT-154.91-R-2020-3-T4

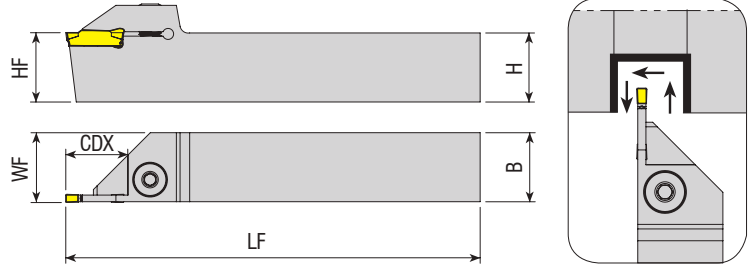

| Takım Kodu<br>Ordering Code<br>Bestell-Bezeichnung | Stok<br>Stock<br>Lager |   | Takım Ölçüleri (mm)<br>Dimension (mm)<br>Abmessung (mm) |    |     |      | Kesici Uç<br>Insert<br>Wendeschneidplatte | Yedek Parçaları / Spare Parts / Ersatzteile |  |                      |   |
|--|------------------------|---|---|----|-----|------|---|---|--|----------------------|---|
|  | R                      | L | HF=H  | B  | LF  | WF   |   | CDX   | Sıkma Vidası<br>Screw<br>Klemmschraube | Pul<br>Stamp<br>Ring | Anahtar<br>Allen Key<br>Innensechskantschlüssel |
| ADKT-TD-R/L-1212-2-T15                             | ●                      | ● | 12  | 12 | 100 | 12.2 | 15  | TD. - 2                                     | AKV-02-M6x22                           | ABPL-01              | AAL-03-3  |
| ADKT-TD-R/L-1616-2-T8                              | ●                      | ● | 16  | 16 | 125 | 16.2 | 8   |   |  |                      |   |
| ADKT-TD-R/L-1616-2-T15                             | ●                      | ● | 16  | 16 | 125 | 16.2 | 15  |   |  |                      |   |
| ADKT-TD-R/L-2020-2-T9                              | ●                      | ○ | 20  | 20 | 125 | 20.2 | 9   |   |  |                      |   |
| ADKT-TD-R/L-2020-2-T15                             | ●                      | ● | 20  | 20 | 125 | 20.2 | 15  |   |  |                      |   |
| ADKT-TD-R/L-2020-2-T17                             | ●                      | ○ | 20  | 20 | 125 | 20.2 | 17  |   |  |                      |   |
| ADKT-TD-R/L-2020-2-T20                             | ●                      | ○ | 20  | 20 | 125 | 20.2 | 20  |   |  |                      |   |
| ADKT-TD-R/L-2525-2-T8                              | ●                      | ● | 25  | 25 | 150 | 25.2 | 8   |   |  |                      |   |
| ADKT-TD-R/L-2525-2-T17                             | ●                      | ● | 25  | 25 | 150 | 25.2 | 17  |   |  |                      |   |
| ADKT-TD-R/L-1212-3-T15                             | ●                      | ● | 12  | 12 | 100 | 12.4 | 15  |   |  |                      |   |
| ADKT-TD-R/L-1616-3-T15                             | ●                      | ● | 16  | 16 | 125 | 16.4 | 15  |   |  |                      |   |
| ADKT-TD-R/L-2020-3-T12                             | ●                      | ● | 20  | 20 | 125 | 20.4 | 12  |   |  |                      |   |
| ADKT-TD-R/L-2020-3-T20                             | ●                      | ● | 20  | 20 | 125 | 20.4 | 20  |   |  |                      |   |
| ADKT-TD-R/L-2020-3-T25                             | ●                      | ○ | 20  | 20 | 125 | 20.4 | 25  |   |  |                      |   |
| ADKT-TD-R/L-2020-3-T30                             | ●                      | ● | 20  | 20 | 125 | 20.4 | 30  |   |  |                      |   |
| ADKT-TD-R/L-2525-3-T9                              | ●                      | ● | 25  | 25 | 150 | 25.4 | 9   |   |  |                      |   |
| ADKT-TD-R/L-2525-3-T12                             | ●                      | ● | 25  | 25 | 150 | 25.4 | 12  |   |  |                      |   |
| ADKT-TD-R/L-2525-3-T22                             | ●                      | ● | 25  | 25 | 150 | 25.4 | 22  |   |  |                      |   |
| ADKT-TD-R/L-2525-3-T25                             | ●                      | ● | 25  | 25 | 150 | 25.4 | 25  |   |  |                      |   |
| ADKT-TD-R/L-2525-3-T30                             | ●                      | ● | 25  | 25 | 150 | 25.4 | 30  | TD. - 4                                     |  |                      |   |
| ADKT-TD-R/L-3232-3-T25                             | ●                      | ○ | 32  | 32 | 170 | 32.4 | 25  |   |  |                      |   |
| ADKT-TD-R/L-2525-4-T10                             | ●                      | ● | 25  | 25 | 150 | 25.5 | 10  |   |  |                      |   |
| ADKT-TD-R/L-2525-4-T15                             | ●                      | ● | 25  | 25 | 150 | 25.5 | 15  |   |  |                      |   |
| ADKT-TD-R/L-2525-4-T22                             | ●                      | ● | 25  | 25 | 150 | 25.5 | 22  |   |  |                      |   |
| ADKT-TD-R/L-2525-4-T25                             | ●                      | ○ | 25  | 25 | 150 | 25.4 | 25  | TD. - 5                                     |  |                      |   |
| ADKT-TD-R/L-2525-4-T30                             | ●                      | ○ | 25  | 25 | 150 | 25.5 | 30  |   |  |                      |   |
| ADKT-TD-R/L-2525-5-T25                             | ●                      | ● | 25  | 25 | 150 | 25.5 | 25  |   |  |                      |   |

TGTC Ucuna Uygun. / Compatible with TGTC Insert. / Kompatibel mit TGTC Wendepfatten.

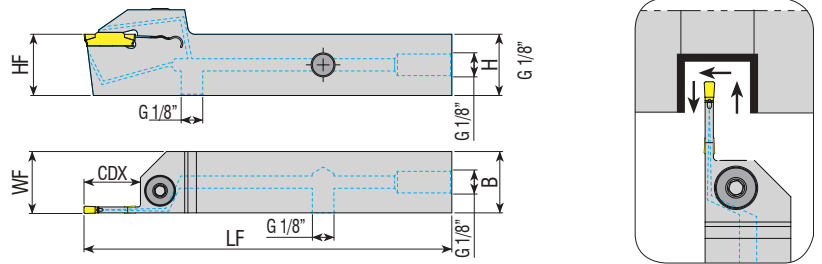

| Takım Kodu<br>Ordering Code<br>Bestell-Bezeichnung | Stok<br>Stock<br>Lager |   | Takım Ölçüleri (mm)<br>Dimension (mm)<br>Abmessung (mm) |    |     |      | Kesici Uç<br>Insert<br>Wendeschneidplatte | Yedek Parçaları / Spare Parts / Ersatzteile |  |                      |   |
|--|------------------------|---|---|----|-----|------|---|---|--|----------------------|---|
|  | R                      | L | HF=H  | B  | LF  | WF   |   | CDX   | Sıkma Vidası<br>Screw<br>Klemmschraube | Pul<br>Stamp<br>Ring | Anahtar<br>Allen Key<br>Innensechskantschlüssel |
| ADKT-TD-R/L-2020-3-T30-H                           | ●                      | ● | 20  | 20 | 125 | 20.5 | 30  | TD. - 3                                     | 2004-M8x1x20                           | -                    | AAL-05-4  |

R: Sağ / Right / Rechts L: Sol / Left / Links  
● Stokta / In Stock / Auf Lager ○ Stokta Yok / Non Stock Item / Kein Lagerartikel, Lieferzeit auf Anfrage  
TGTC Ucuna Uygun. / Compatible with TGTC Insert. / Kompatibel mit TGTC Wendepfatten.

Sipariş Örneği/Ordering Example/Bestellbeispiel  
1 ad./pcs./stück ADKT-TD-R-1212-2-T15



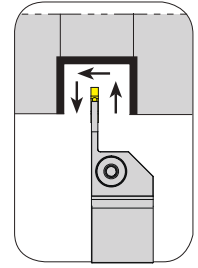
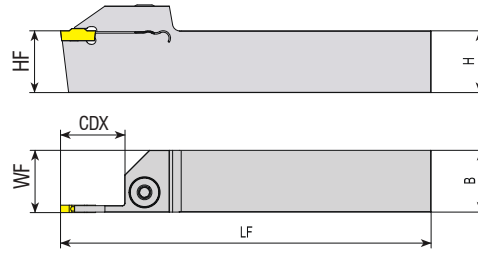
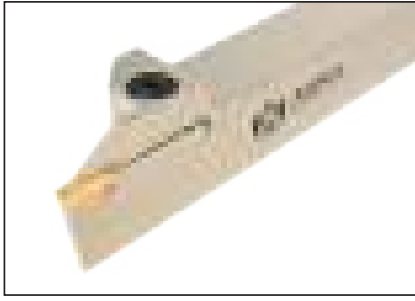

**Takım Kodu**  
**Ordering Code**  
**Bestell-Bezeichnung**

| Stok<br>Stock<br>Lager | Takım Ölçüleri (mm)<br>Dimension (mm)<br>Abmessung (mm) |    |      |     |      |    | Kesici Uç<br>Insert<br>Wendeschneidplatte | Yedek Parçaları / Spare Parts / Ersatzteile |  |                      |   |
|------------------------|---|----|------|-----|------|----|---|---|--|----------------------|---|
|                        | R   | L  | HF=H | B   | LF   | WF |   | CDX   | Sıkma Vidası<br>Screw<br>Klemmschraube | Pul<br>Stamp<br>Ring | Anahtar<br>Allen Key<br>Innensechskantschlüssel |
| ● ○                    | ○   | 16 | 16   | 125 | 16.2 | 17 | RD. - 2                                   | AKV-02-M6x22                                | ABPL-01                                | AAL-03-3             |   |
| ● ○                    | ○   | 20 | 20   | 125 | 20.2 | 17 |   |   |  |                      |   |
| ● ○                    | ○   | 25 | 25   | 150 | 25.2 | 17 |   |   |  |                      |   |
| ● ●                    | ●   | 16 | 16   | 125 | 16.3 | 20 | RD. - 3                                   | 2004-M8x1x20                                | -                                      | AAL-05-4             | -   |
| ● ○                    | ○   | 20 | 20   | 125 | 20.3 | 25 |   |   |  |                      |   |
| ● ○                    | ○   | 25 | 25   | 150 | 25.3 | 25 |   |   |  |                      |   |
| ● ●                    | ●   | 20 | 20   | 125 | 20.4 | 30 | RD. - 4                                   |   |  |                      |   |
| ● ○                    | ○   | 25 | 25   | 150 | 25.5 | 30 |   |   |  |                      |   |

TGTC Ucuna Uygun. / Compatible with TGTC Insert. / Kompatibel mit TGTC Wendepatten.

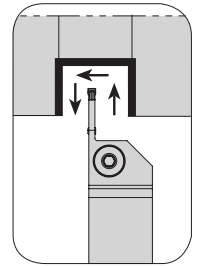
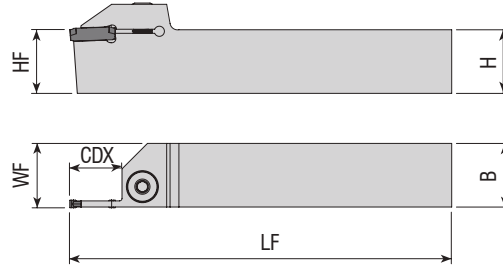

**Takım Kodu**  
**Ordering Code**  
**Bestell-Bezeichnung**

| Stok<br>Stock<br>Lager | Takım Ölçüleri (mm)<br>Dimension (mm)<br>Abmessung (mm) |    |      |     |      |    | Kesici Uç<br>Insert<br>Wendeschneidplatte | Yedek Parçaları / Spare Parts / Ersatzteile |  |                      |
|------------------------|---|----|------|-----|------|----|---|---|--|----------------------|
|                        | R   | L  | HF=H | B   | LF   | WF |   | CDX   | Sıkma Vidası<br>Screw<br>Klemmschraube | Pul<br>Stamp<br>Ring |
| ● ●                    | ●   | 16 | 16   | 125 | 16.2 | 20 | GCTX - 2                                  | AKV-02-M6x22                                | ABPL-01                                | AAL-03-3             |
| ● ●                    | ●   | 20 | 20   | 125 | 20.2 | 20 |   |   |  |                      |
| ● ●                    | ●   | 25 | 25   | 150 | 25.2 | 20 |   |   |  |                      |
| ● ●                    | ●   | 16 | 16   | 125 | 16.3 | 20 | GCTX - 3                                  | 2004-M8x1x20                                | -                                      | AAL-05-4             |
| ● ●                    | ●   | 20 | 20   | 125 | 20.3 | 20 |   |   |  |                      |
| ● ●                    | ●   | 25 | 25   | 150 | 25.3 | 20 |   |   |  |                      |

R: Sağ / Right / Rechts L: Sol / Left / Links

● Stokta / In Stock / Auf Lager ○ Stokta Yok / Non Stock Item / Kein Lagerartikel, Lieferzeit auf Anfrage

LMN Ucuna Uygun. / Compatible with LMN Insert. / Kompatibel mit LMN Wendepatten.

Sipariş Örneği/Ordering Example/Bestellbeispiel

1 ad./pcs./stück ADKT-RD-R-1616-2-T17

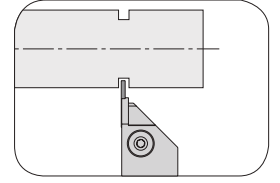
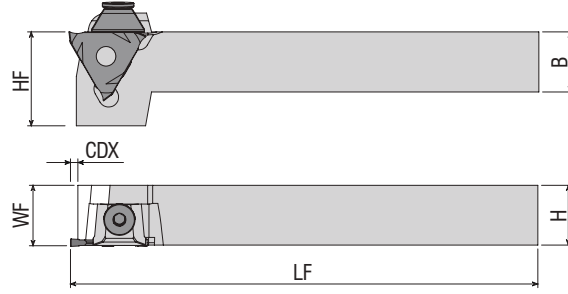

| Takım Kodu<br>Ordering Code<br>Bestell-Bezeichnung | Stok<br>Stock<br>Lager |   | Takım Ölçüleri (mm)<br>Dimension (mm)<br>Abmessung (mm) |    |     |       | Kesici Uç<br>Insert<br>Wendeschneidplatte | Yedek Parçaları / Spare Parts / Ersatzteile |  |  |                         |   |
|--|------------------------|---|---|----|-----|-------|---|---|--|--|-------------------------|---|
|  | R                      | L | HF=H  | B  | LF  | WF    |   | CDX   | Sıkma Vidası<br>Screw<br>Klemmschraube | Baskı Pabucu<br>Wedge Clamp<br>Spannpratze | Segman<br>Ring<br>Feder | Anahtar<br>Allen Key<br>Innensechskantschlüssel |
| ADKT-H22-R/L-1616-(0.5-2)-T4                       | ●                      | ● | 16  | 16 | 125 | 16.35 | 4   | S312 - (0.5-2)                              | AKV-29-M6x29                           | AKK-04                                     | AS-01                   | AAL-03-3  |
| ADKT-H22-R/L-2020-(0.5-2)-T4                       | ●                      | ● | 20  | 20 | 125 | 20.35 | 4   |   |  |  |                         |   |
| <b>new</b> ADKT-H22-R/L-2020-(0.5-2)-T6x20         | ●                      | ○ | 20  | 20 | 125 | 20.2  | 20  |   |  |  |                         |   |
| ADKT-H22-R/L-2525-(0.5-2)-T4                       | ●                      | ● | 25  | 25 | 150 | 25.35 | 4   |   |  |  |                         |   |
| <b>new</b> ADKT-H22-R/L-2525-(0.5-2)-T6x20         | ●                      | ○ | 25  | 25 | 150 | 20.2  | 2   |   |  |  |                         |   |

HRN Ucuna Uygun. / Compatible with HRN Insert. / Kompatibel mit HRN Wendepplatten.

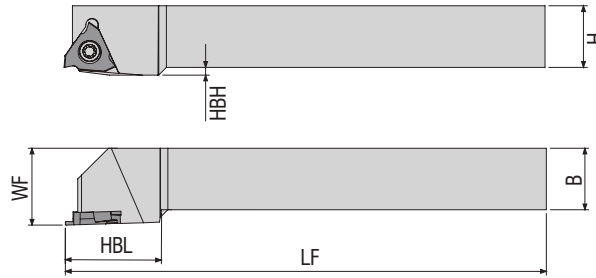

| Takım Kodu<br>Ordering Code<br>Bestell-Bezeichnung | Stok<br>Stock<br>Lager |   | Takım Ölçüleri (mm)<br>Dimension (mm)<br>Abmessung (mm) |    |     | Kesici Uç<br>Insert<br>Wendeschneidplatte | Yedek Parçaları / Spare Parts / Ersatzteile |  |                      |  |
|--|------------------------|---|---|----|-----|---|---|--|----------------------|--|
|  | R                      | L | HF=H  | B  | LF  |   | WF  | Sıkma Vidası<br>Screw<br>Klemmschraube | Pul<br>Stamp<br>Ring | Tork Anahtar<br>Torx Key<br>Torx Innensechskantschlüssel |
| ADKT-GB-R/L-1212-3                                 | ●                      | ○ | 12  | 12 | 100 | 16  | GB3100                                      | 4015-M3.5x10                           | -                    | 80-T15   |
| ADKT-GB-R/L-1616-3                                 | ●                      | ○ | 16  | 16 | 125 | 20  |   |  |                      |  |
| ADKT-GB-R/L-2020-3                                 | ●                      | ○ | 20  | 20 | 125 | 25  |   |  |                      |  |

R: Sağ / Right / Rechts L: Sol / Left / Links

● Stokta / In Stock / Auf Lager ○ Stokta Yok / Non Stock Item / Kein Lagerartikel, Lieferzeit auf Anfrage

XTC-GSC Ucuna Uygun. / Compatible with XTC-GSC Insert. / Kompatibel mit XTC-GSC Wendepplatten.

Sipariş Örneği/Ordering Example/Bestellbeispiel

1 ad./pcs./stück ADKT-H22-R-1616-(0.5-2)-T4

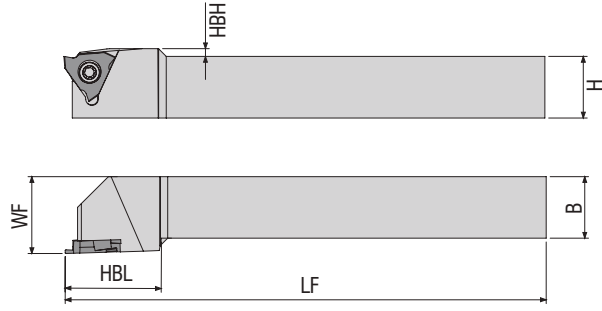

| Takım Kodu<br>Ordering Code<br>Bestell-Bezeichnung | Stok<br>Stock<br>Lager |   | Takım Ölçüleri (mm)<br>Dimension (mm)<br>Abmessung (mm) |    |     |    | Kesici Uç<br>Insert<br>Wendeschneidplatte | Yedek Parçaları / Spare Parts / Ersatzteile |                      |  |          |              |   |        |
|--|------------------------|---|---|----|-----|----|---|---|----------------------|--|----------|--------------|---|--------|
|  | R                      | L | HF=H  | B  | LF  | WF |   | Sıkma Vidası<br>Screw<br>Klemmschraube      | Pul<br>Stamp<br>Ring | Tork Anahtar<br>Torx Key<br>Torx Innensechskantschlüssel |          |              |   |        |
| ADKT-TGF-R/L-1616-3                                | ●                      | ○ | 16  | 16 | 125 | 20 |   |   |                      |  |          |              |   |        |
| ADKT-TGF-R/L-2020-3                                | ●                      | ○ | 20  | 20 | 125 | 25 |   |   |                      |  | QC16L150 | 4015-M3.5X10 | - | 80-T15 |
| ADKT-TGF-R/L-2525-3                                | ●                      | ○ | 25  | 25 | 150 | 32 |   |   |                      |  |          |              |   |        |

NTK Ucuna Uygun. / Compatible with NTK Insert. / Kompatibel mit NTK Wendeplatten.

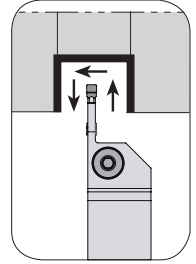
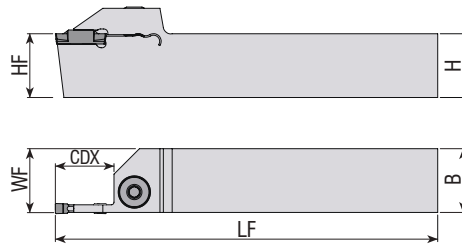

| Takım Kodu<br>Ordering Code<br>Bestell-Bezeichnung | Stok<br>Stock<br>Lager |   | Takım Ölçüleri (mm)<br>Dimension (mm)<br>Abmessung (mm) |    |     |      |     | Kesici Uç<br>Insert<br>Wendeschneidplatte | Yedek Parçaları / Spare Parts / Ersatzteile |                      |   |
|--|------------------------|---|---|----|-----|------|-----|---|---|----------------------|---|
|  | R                      | L | HF=H  | B  | LF  | WF   | CDX |   | Sıkma Vidası<br>Screw<br>Klemmschraube      | Pul<br>Stamp<br>Ring | Anahtar<br>Allen Key<br>Innensechskantschlüssel |
| ADKT-TG-R/L-1616-2-R17                             | ●                      | ○ | 16  | 16 | 125 | 16.2 | 17  |   |   |                      |   |
| ADKT-TG-R/L-2020-2-R8                              | ●                      | ○ | 20  | 20 | 125 | 20.2 | 8   |   |   |                      |   |
| ADKT-TG-R/L-2020-2-T8                              | ●                      | ○ | 20  | 20 | 125 | 20.2 | 8   |   |   |                      |   |
| ADKT-TG-R/L-2020-2-R12                             | ●                      | ○ | 20  | 20 | 125 | 20.2 | 12  |   |   |                      |   |
| ADKT-TG-R/L-2525-2-R12                             | ●                      | ○ | 25  | 25 | 150 | 25.2 | 12  |   |   |                      |   |
| ADKT-TG-R/L-2525-2-R17                             | ●                      | ○ | 25  | 25 | 150 | 25.2 | 17  |   |   |                      |   |
| ADKT-TG-R/L-1616-3-T20                             | ●                      | ○ | 16  | 16 | 125 | 16.3 | 20  |   |   |                      |   |
| ADKT-TG-R/L-2020-3-T12                             | ●                      | ○ | 20  | 20 | 125 | 20.3 | 12  |   |   |                      |   |
| ADKT-TG-R/L-2020-3-T20                             | ●                      | ○ | 20  | 20 | 125 | 20.3 | 20  |   |   |                      |   |
| ADKT-TG-R/L-2525-3-T9                              | ●                      | ○ | 25  | 25 | 150 | 25.3 | 9   |   |   |                      |   |
| ADKT-TG-R/L-2525-3-T20                             | ●                      | ○ | 25  | 25 | 150 | 25.3 | 20  |   |   |                      |   |
| ADKT-TG-R/L-2525-3-R25                             | ●                      | ○ | 25  | 25 | 150 | 25.3 | 25  |   |   |                      |   |
| ADKT-TG-R/L-2525-4-T15                             | ●                      | ○ | 25  | 25 | 150 | 25.5 | 15  |   |   |                      |   |
| ADKT-TG-R/L-2525-4-T20                             | ●                      | ○ | 25  | 25 | 150 | 25.5 | 20  |   |   |                      |   |
| ADKT-TG-R/L-2525-4-T25                             | ●                      | ○ | 25  | 25 | 150 | 25.5 | 25  |   |   |                      |   |
| ADKT-TG-R/L-2525-5-T12                             | ●                      | ○ | 25  | 25 | 150 | 25.5 | 12  |   |   |                      |   |
| ADKT-TG-R/L-2525-5-T25                             | ●                      | ○ | 25  | 25 | 150 | 25.5 | 25  |   |   |                      |   |
| ADKT-TG-R/L-2525-5-T32                             | ●                      | ○ | 25  | 25 | 150 | 25.5 | 32  |   |   |                      |   |

R: Sağ / Right / Rechts L: Sol / Left / Links

● Stokta / In Stock / Auf Lager ○ Stokta Yok / Non Stock Item / Kein Lagerartikel, Lieferzeit auf Anfrage  
TNGLY Ucuna Uygun. / Compatible with TNGLY Insert. / Kompatibel mit TNGLY Wendeplatten.

Sipariş Örneği/Ordering Example/Bestellbeispiel  
1 ad./pcs./stück ADKT-TGF-R-1616-3

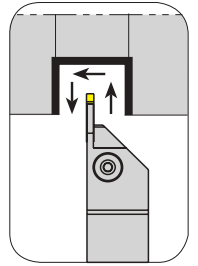
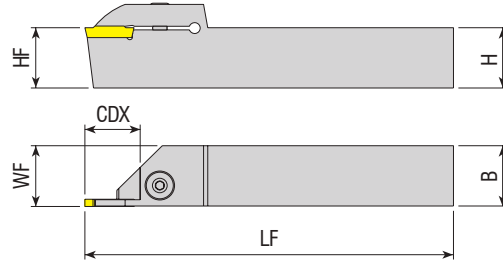

| Takım Kodu<br>Ordering Code<br>Bestell-Bezeichnung | Stok<br>Stock<br>Lager |   | Takım Ölçüleri (mm)<br>Dimension (mm)<br>Abmessung (mm) |    |     |      |     | Kesici Uç<br>Insert<br>Wendeschneidplatte | Yedek Parçaları / Spare Parts / Ersatzteile |                      |   |  |
|--|------------------------|---|---|----|-----|------|-----|---|---|----------------------|---|--|
|  | R                      | L | HF=H  | B  | LF  | WF   | CDX |   | Sıkma Vidası<br>Screw<br>Klemmschraube      | Pul<br>Stamp<br>Ring | Anahtar<br>Allen Key<br>Innensechskantschlüssel |  |
| ADKT-WGX16-R/L-2020-2-R16                          | ●                      | ○ | 20  | 20 | 125 | 20.2 | 16  | GX16. - 2                                 | AKV-02-M6x22                                | ABPL-01              | AAL-03-3  |  |
| ADKT-WGX16-R/L-2525-2-R16                          | ●                      | ○ | 25  | 25 | 150 | 25.2 | 16  |   |   |                      |   |  |
| ADKT-WGX24-R/L-2020-3-T20                          | ●                      | ● | 20  | 20 | 125 | 20.4 | 20  | GX24. - 3                                 | 2004-M8x1x20                                | -                    | AAL-05-4  |  |
| ADKT-WGX24-R/L-2525-3-T12                          | ●                      | ● | 25  | 25 | 150 | 25.4 | 12  |   |   |                      |   |  |
| ADKT-WGX24-R/L-2525-3-T22                          | ●                      | ● | 25  | 25 | 150 | 25.4 | 22  | GX24. - 4                                 | -   | -                    | -   |  |
| ADKT-WGX24-R/L-3232-3-T22                          | ●                      | ○ | 32  | 32 | 170 | 32.4 | 22  |   |   |                      |   |  |
| ADKT-WGX24-R/L-2525-4-T22                          | ●                      | ● | 25  | 25 | 150 | 25.5 | 22  | GX24. - 5                                 | -   | -                    | -   |  |
| ADKT-WGX24-R/L-2525-5-T25                          | ●                      | ● | 25  | 25 | 150 | 25.5 | 25  |   |   |                      |   |  |
| ADKT-WGX24-R/L-3232-5-T25                          | ●                      | ● | 32  | 32 | 170 | 32.5 | 25  |   |   |                      |   |  |

WLTR Ucuna Uygun. / Compatible with WLTR Insert. / Kompatibel mit WLTR Wendepfatten.

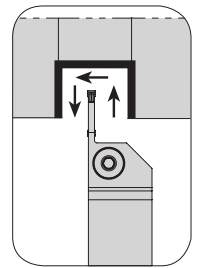
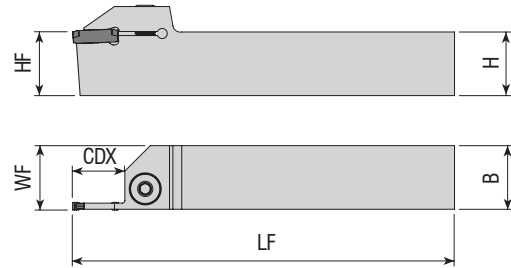

| Takım Kodu<br>Ordering Code<br>Bestell-Bezeichnung | Stok<br>Stock<br>Lager |   | Takım Ölçüleri (mm)<br>Dimension (mm)<br>Abmessung (mm) |    |     |      |     | Kesici Uç<br>Insert<br>Wendeschneidplatte | Yedek Parçaları / Spare Parts / Ersatzteile |                      |   |  |
|--|------------------------|---|---|----|-----|------|-----|---|---|----------------------|---|--|
|  | R                      | L | HF=H  | B  | LF  | WF   | CDX |   | Sıkma Vidası<br>Screw<br>Klemmschraube      | Pul<br>Stamp<br>Ring | Anahtar<br>Allen Key<br>Innensechskantschlüssel |  |
| ADKT-GP-R/L-2020-2-T15                             | ●                      | ● | 20  | 20 | 125 | 20.2 | 15  | GP - 2                                    | AKV-02-M6x22                                | ABPL-01              | AAL-03-3  |  |
| ADKT-GP-R/L-2525-2-T15                             | ●                      | ● | 25  | 25 | 150 | 25.2 | 15  |   |   |                      |   |  |
| ADKT-GP-R/L-2020-3-T20                             | ●                      | ● | 20  | 20 | 125 | 20.3 | 20  | GP - 3                                    | 2004-M8x1x20                                | -                    | AAL-05-4  |  |
| ADKT-GP-R/L-2525-3-T22                             | ●                      | ● | 25  | 25 | 150 | 25.3 | 22  |   |   |                      |   |  |
| ADKT-GP-R/L-2525-4-T22                             | ●                      | ● | 25  | 25 | 150 | 25.4 | 22  | GP - 4                                    | -   | -                    | -   |  |
| ADKT-GP-R/L-2525-5-T25                             | ●                      | ● | 25  | 25 | 150 | 25.5 | 25  |   |   |                      |   |  |
| ADKT-GP-R/L-2525-5-T25                             | ●                      | ● | 25  | 25 | 150 | 25.5 | 25  | GP - 5                                    |   |                      |   |  |

R: Sağ / Right / Rechts L: Sol / Left / Links

● Stokta / In Stock / Auf Lager ○ Stokta Yok / Non Stock Item / Kein Lagerartikel, Lieferzeit auf Anfrage  
PLBT Ucuna Uygun. / Compatible with PLBT Insert. / Kompatibel mit PLBT Wendepfatten.

Sipariş Örneği/Ordering Example/Bestellbeispiel  
1 ad./pcs./stück ADKT-WGX16-R-2020-2-R16

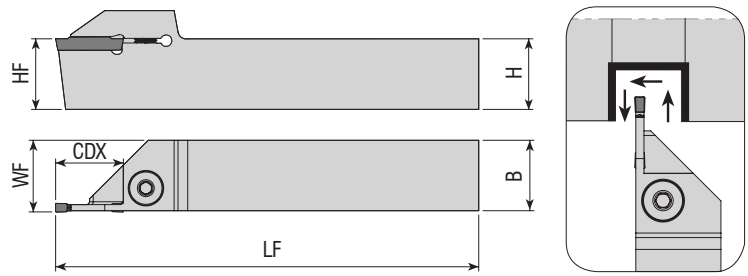
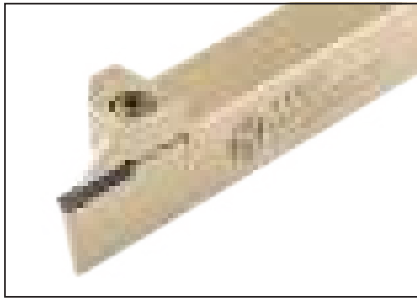

**Takım Kodu**  
**Ordering Code**  
**Bestell-Bezeichnung**

| Stok<br>Stock<br>Lager |     | Takım Ölçüleri (mm)<br>Dimension (mm)<br>Abmessung (mm) |    |     |      |     | Kesici Uç<br>Insert<br>Wendeschneidplatte | Yedek Parçaları / Spare Parts / Ersatzteile |   |          |
|------------------------|-----|---|----|-----|------|-----|---|---|---|----------|
| R                      | L   | HF=H  | B  | LF  | WF   | CDX | Sıkma Vidası<br>Screw<br>Klemmschraube    | Pul<br>Stamp<br>Ring                        | Anahtar<br>Allen Key<br>Innensechskantschlüssel |          |
| ADKT-CD-R/L-2020-3-R20 | ● ○ | 20  | 20 | 125 | 20.3 | 20  |   |   |   |          |
| ADKT-CD-R/L-2525-3-R23 | ● ○ | 25  | 25 | 150 | 25.3 | 23  | <b>GX24 0300</b>                          | 2004-M8x1x20                                | -   | AAL-05-4 |

CRTZT Ucuna Uygundur. / Compatible with CRTZT Insert. / Kompatibel mit CRTZT Wendeplatten.

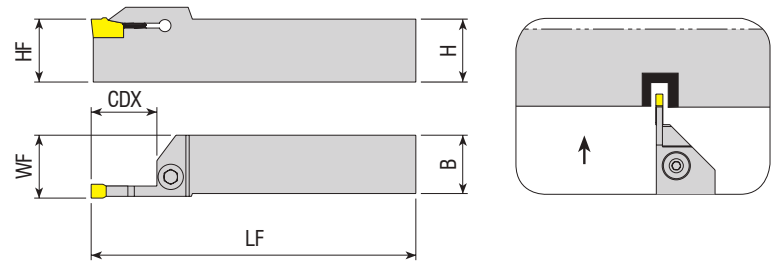

**Takım Kodu**  
**Ordering Code**  
**Bestell-Bezeichnung**

| Stok<br>Stock<br>Lager  |     | Takım Ölçüleri (mm)<br>Dimension (mm)<br>Abmessung (mm) |    |     |      |     | Kesici Uç<br>Insert<br>Wendeschneidplatte | Yedek Parçaları / Spare Parts / Ersatzteile |   |          |
|-------------------------|-----|---|----|-----|------|-----|---|---|---|----------|
| R                       | L   | HF=H  | B  | LF  | WF   | CDX | Sıkma Vidası<br>Screw<br>Klemmschraube    | Pul<br>Stamp<br>Ring                        | Anahtar<br>Allen Key<br>Innensechskantschlüssel |          |
| ADKT-SWC-R/L-2020-2-T25 | ● ○ | 20  | 20 | 125 | 20.3 | 25  |   |   |   |          |
| ADKT-SWC-R/L-2020-3-T25 | ● ○ | 20  | 20 | 125 | 20.4 | 25  | <b>WCF - 3</b>                            | 2004-M8x1x20                                | -   | AAL-05-4 |

SMTM Ucuna Uygundur. / Compatible with SMTM Insert. / Kompatibel mit SMTM Wendeplatten.

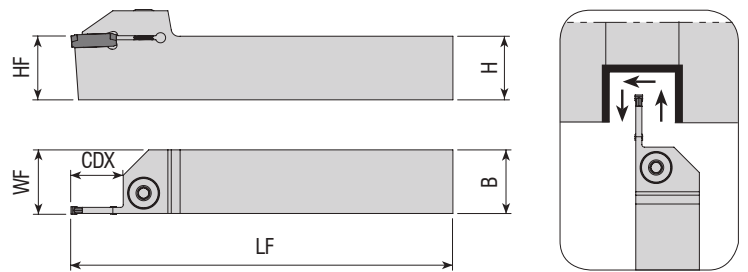

**Takım Kodu**  
**Ordering Code**  
**Bestell-Bezeichnung**

| Stok<br>Stock<br>Lager  |     | Takım Ölçüleri (mm)<br>Dimension (mm)<br>Abmessung (mm) |    |     |      |     | Kesici Uç<br>Insert<br>Wendeschneidplatte | Yedek Parçaları / Spare Parts / Ersatzteile |   |          |
|-------------------------|-----|---|----|-----|------|-----|---|---|---|----------|
| R                       | L   | HF=H  | B  | LF  | WF   | CDX | Sıkma Vidası<br>Screw<br>Klemmschraube    | Pul<br>Stamp<br>Ring                        | Anahtar<br>Allen Key<br>Innensechskantschlüssel |          |
| ADKT-GY2-R/L-2525-2-R20 | ● ○ | 25  | 25 | 150 | 25.2 | 20  |   |   |   |          |
| ADKT-GY2-R/L-2525-3-R20 | ● ○ | 25  | 25 | 150 | 25.3 | 20  | <b>GY2M-0300</b>                          | 2004-M8x1x20                                |   |          |
| ADKT-GY2-R/L-2525-4-T25 | ● ○ | 25  | 25 | 150 | 25.4 | 25  | <b>GY2M-0400</b>                          | 2004-M8x1x20                                |   |          |
| ADKT-GY2-R/L-2525-5-T25 | ● ○ | 25  | 25 | 150 | 25.5 | 25  | <b>GY2M-0500</b>                          | 2004-M8x1x20                                | -   | AAL-05-4 |

R: Sağ / Right / Rechts L: Sol / Left / Links

● Stokta / In Stock / Auf Lager ○ Stokta Yok / Non Stock Item / Kein Lagerartikel, Lieferzeit auf Anfrage

MTSBH Ucuna Uygundur. / Compatible with MTSBH Insert. / Kompatibel mit MTSBH Wendeplatten.

Sipariş Örneği/Ordering Example/Bestellbeispiel

1 ad./pcs./stück ADKT-CD-R-2020-3-R20

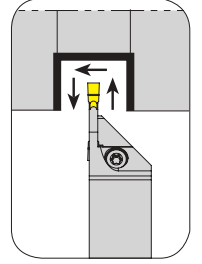
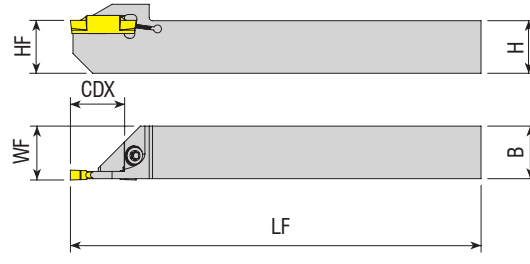

| Takım Kodu<br>Ordering Code<br>Bestell-Bezeichnung | Stok<br>Stock<br>Lager |   | Takım Ölçüleri (mm)<br>Dimension (mm)<br>Abmessung (mm) |    |     |      | Kesici Uç<br>Insert<br>Wendeschneidplatte | Yedek Parçaları / Spare Parts / Ersatzteile |  |                      |  |
|--|------------------------|---|---|----|-----|------|---|---|--|----------------------|--|
|  | R                      | L | HF=H  | B  | LF  | WF   |   | CDX   | Sıkma Vidası<br>Screw<br>Klemmschraube | Pul<br>Stamp<br>Ring | Tork Anahtar<br>Torx Key<br>Torx Innensechskantschlüssel |
| <b>new</b> ADKT-TD-R/L-1010-2-R10-K-S              | ●                      | ● | 10  | 10 | 125 | 10.2 | 10  | TD. - 2                                     | 4015-M4x11                             | -                    | 80-T15   |
| ADKT-TD-R/L-1212-2-T12-K-S                         | ●                      | ● | 12  | 12 | 125 | 12.2 | 12  |   |  |                      |  |
| ADKT-TD-R/L-1616-2-T16-K-S                         | ●                      | ● | 16  | 16 | 125 | 16.2 | 16  | TD. - 3                                     | 4015-M4x11                             | -                    | 80-T15   |
| ADKT-TD-R/L-1212-3-T12-K-S                         | ●                      | ● | 12  | 12 | 125 | 12.3 | 12  |   |  |                      |  |
| ADKT-TD-R/L-1616-3-T16-K-S                         | ●                      | ● | 16  | 16 | 125 | 16.3 | 16  |   |  |                      |  |

TGTC Ucuna Uygundur. / Compatible with TGTC Insert. / Kompatibel mit TGTC Wendeplatten.

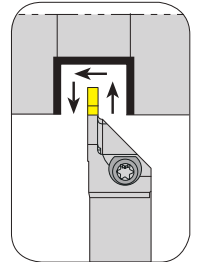
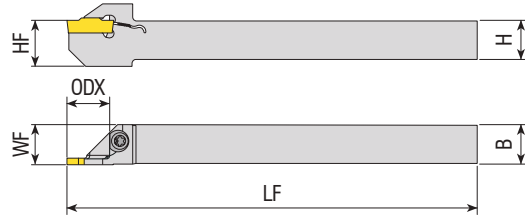

| Takım Kodu<br>Ordering Code<br>Bestell-Bezeichnung | Stok<br>Stock<br>Lager |   | Takım Ölçüleri (mm)<br>Dimension (mm)<br>Abmessung (mm) |    |     |      | Kesici Uç<br>Insert<br>Wendeschneidplatte | Yedek Parçaları / Spare Parts / Ersatzteile |  |                      |  |
|--|------------------------|---|---|----|-----|------|---|---|--|----------------------|--|
|  | R                      | L | HF=H  | B  | LF  | WF   |   | CDX   | Sıkma Vidası<br>Screw<br>Klemmschraube | Pul<br>Stamp<br>Ring | Tork Anahtar<br>Torx Key<br>Torx Innensechskantschlüssel |
| ADKT-RD-R/L-1212-2-T12-K-S                         | ●                      | ● | 12  | 12 | 125 | 12.2 | 12  | RD. - 2                                     | 4015-M4x11                             | -                    | 80-T15   |
| ADKT-RD-R/L-1616-2-T17-K-S                         | ●                      | ● | 16  | 16 | 125 | 16.2 | 17  |   |  |                      |  |
| ADKT-RD-R/L-1212-3-T12-K-S                         | ●                      | ● | 12  | 12 | 125 | 12.2 | 12  | RD. - 3                                     | 4015-M4x11                             | -                    | 80-T15   |

R: Sağ / Right / Rechts L: Sol / Left / Links

● Stokta / In Stock / Auf Lager ○ Stokta Yok / Non Stock Item / Kein Lagerartikel, Lieferzeit auf Anfrage

TGTC Ucuna Uygundur. / Compatible with TGTC Insert. / Kompatibel mit TGTC Wendeplatten.

Sipariş Örneği/Ordering Example/Bestellbeispiel

1 ad./pcs./stück ADKT-TD-R-1010-2-R10-K-S

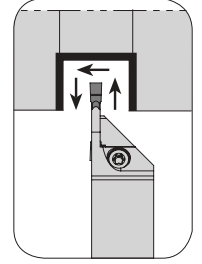
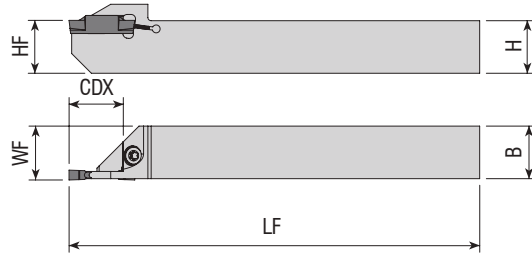

| Takım Kodu<br>Ordering Code<br>Bestell-Bezeichnung | Stok<br>Stock<br>Lager |   | Takım Ölçüleri (mm)<br>Dimension (mm)<br>Abmessung (mm) |    |     |      |     | Kesici Uç<br>Insert<br>Wendeschneidplatte | Yedek Parçaları / Spare Parts / Ersatzteile |                      |  |
|--|------------------------|---|---|----|-----|------|-----|---|---|----------------------|--|
|  | R                      | L | HF=H  | B  | LF  | WF   | CDX |   | Sıkma Vidası<br>Screw<br>Klemmschraube      | Pul<br>Stamp<br>Ring | Tork Anahtar<br>Torx Key<br>Torx Innensechskantschlüssel |
| ADKT-ZCC2-R/L-1010-2-T12-K-S                       | ●                      | ● | 10  | 10 | 125 | 10.2 | 12  | Z.BD - 2                                  | 4015-M4x11                                  | -                    | 80-T15   |
| ADKT-ZCC2-R/L-1212-2-T12-K-S                       | ●                      | ● | 12  | 12 | 125 | 12.2 | 12  |   |   |                      |  |
| ADKT-ZCC2-R/L-1616-2-R16-K-S                       | ●                      | ● | 16  | 16 | 125 | 16.2 | 16  | Z.FD - 3                                  |   |                      |  |
| ADKT-ZCC2-R/L-1212-3-T12-K-S                       | ●                      | ● | 12  | 12 | 125 | 12.3 | 12  |   |   |                      |  |

ZCC Ucuna Uygundur. / Compatible with ZCC Insert. / Kompatibel mit ZCC Wendeplatten.

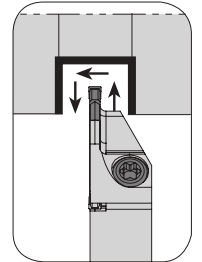
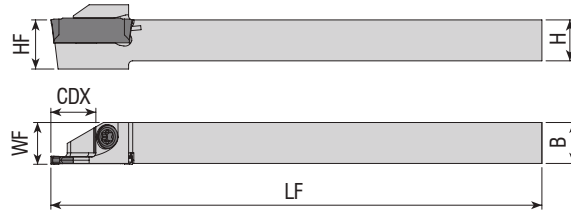

| Takım Kodu<br>Ordering Code<br>Bestell-Bezeichnung | Stok<br>Stock<br>Lager |   | Takım Ölçüleri (mm)<br>Dimension (mm)<br>Abmessung (mm) |    |     |      |     | Kesici Uç<br>Insert<br>Wendeschneidplatte | Yedek Parçaları / Spare Parts / Ersatzteile |                      |  |
|--|------------------------|---|---|----|-----|------|-----|---|---|----------------------|--|
|  | R                      | L | HF=H  | B  | LF  | WF   | CDX |   | Sıkma Vidası<br>Screw<br>Klemmschraube      | Pul<br>Stamp<br>Ring | Tork Anahtar<br>Torx Key<br>Torx Innensechskantschlüssel |
| ADKT-I-R/L-0808-2-R10-S                            | ●                      | ● | 08  | 08 | 100 | 8.2  | 10  | DGN - 2                                   | 4015-M4x11                                  | -                    | 80-T15   |
| ADKT-I-R/L-1010-2-R10-K-S                          | ●                      | ● | 10  | 10 | 125 | 10.2 | 10  |   |   |                      |  |
| ADKT-I-R/L-1212-2-R12-K-S                          | ●                      | ● | 12  | 12 | 125 | 12.2 | 12  | DGN - 3                                   |   |                      |  |
| ADKT-I-R/L-1616-2-R16-K-S                          | ●                      | ○ | 16  | 16 | 125 | 16.2 | 16  |   |   |                      |  |
| ADKT-I-R/L-1616-3-R16-K-S                          | ●                      | ● | 16  | 16 | 125 | 16.3 | 16  |   |   |                      |  |

R: Sağ / Right / Rechts L: Sol / Left / Links  
● Stokta / In Stock / Auf Lager ○ Stokta Yok / Non Stock Item / Kein Lagerartikel, Lieferzeit auf Anfrage  
ISCR Ucuna Uygundur. / Compatible with ISCR Insert. / Kompatibel mit ISCR Wendeplatten.

Sipariş Örneği/Ordering Example/Bestellbeispiel  
1 ad./pcs./stück ADKT-ZCC2-R-1010-2-T12-K-S

DIŞ ÇAP KANAL AÇMA İSVİÇRE TİPİ KAYAR OTOMAT MAKİNA TAKIMLARI  
EXTERNAL GROOVING TOOLHOLDERS FOR SWISS TYPE SLIDING AUTOMATIC LATHES  
WERKZEUGE ZUR STECHBEARBEITUNG AUF LANGDREHAUTOMATEN

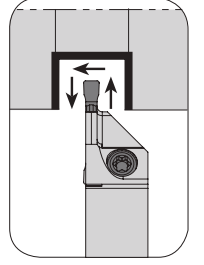
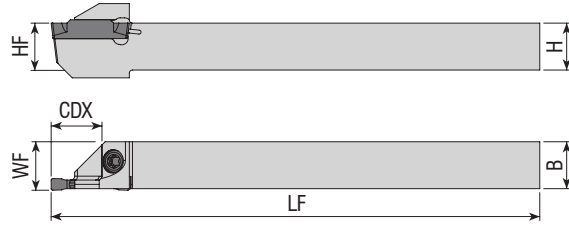

| Takım Kodu<br>Ordering Code<br>Bestell-Bezeichnung | Stok<br>Stock<br>Lager |   | Takım Ölçüleri (mm)<br>Dimension (mm)<br>Abmessung (mm) |    |     |      | Kesici Uç<br>Insert<br>Wendeschneidplatte | Yedek Parçaları / Spare Parts / Ersatzteile |  |                      |  |
|--|------------------------|---|---|----|-----|------|---|---|--|----------------------|--|
|  | R                      | L | HF=H  | B  | LF  | WF   |   | CDX   | Sıkma Vidası<br>Screw<br>Klemmschraube | Pul<br>Stamp<br>Ring | Tork Anahtar<br>Torx Key<br>Torx Innensechskantschlüssel |
| ADKT-KG-R/L-1212-2-R12-K-S                         | ●                      | ● | 12  | 12 | 125 | 12.2 | 12  | KG. - 2                                     | 4015-M4x11                             | -                    | 80-T15   |
| ADKT-KG-R/L-1616-2-R16-K-S                         | ●                      | ● | 16  | 16 | 125 | 16.2 | 16  |   |  |                      |  |
| ADKT-KG-R/L-1212-3-R12-K-S                         | ●                      | ● | 12  | 12 | 125 | 12.3 | 12  | KG. - 3                                     | -                                      | -                    | -  |
| ADKT-KG-R/L-1616-3-R16-K-S                         | ●                      | ● | 16  | 16 | 125 | 16.3 | 16  |   |  |                      |  |

KRLY Ucuna Uygunur. / Compatible with KRLY Insert. / Kompatibel mit KRLY Wendeplatten.

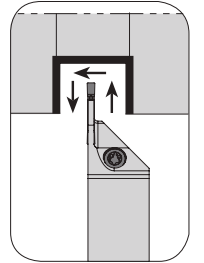
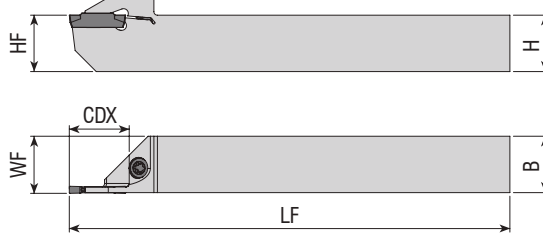

| Takım Kodu<br>Ordering Code<br>Bestell-Bezeichnung | Stok<br>Stock<br>Lager |   | Takım Ölçüleri (mm)<br>Dimension (mm)<br>Abmessung (mm) |    |     |       | Kesici Uç<br>Insert<br>Wendeschneidplatte | Yedek Parçaları / Spare Parts / Ersatzteile |  |                      |  |
|--|------------------------|---|---|----|-----|-------|---|---|--|----------------------|--|
|  | R                      | L | HF=H  | B  | LF  | WF    |   | CDX   | Sıkma Vidası<br>Screw<br>Klemmschraube | Pul<br>Stamp<br>Ring | Tork Anahtar<br>Torx Key<br>Torx Innensechskantschlüssel |
| ADKT-K-R/L-1212-2-R12-K-S                          | ●                      | ● | 12  | 12 | 125 | 12.20 | 12  | MGM. - 2                                    | 4015-M4x11                             | -                    | 80-T15   |
| ADKT-K-R/L-1616-2-R16-K-S                          | ●                      | ● | 16  | 16 | 125 | 16.20 | 16  |   |  |                      |  |
| ADKT-K-R/L-1212-3-R12-K-S                          | ●                      | ● | 12  | 12 | 125 | 12.30 | 12  | MGM. - 3                                    | -                                      | -                    | -  |
| ADKT-K-R/L-1616-3-R16-K-S                          | ●                      | ● | 16  | 16 | 125 | 16.30 | 16  |   |  |                      |  |

R: Sağ / Right / Rechts L: Sol / Left / Links

● Stokta / In Stock / Auf Lager ○ Stokta Yok / Non Stock Item / Kein Lagerartikel, Lieferzeit auf Anfrage

KRLY Ucuna Uygunur. / Compatible with KRLY Insert. / Kompatibel mit KRLY Wendeplatten.

Sipariş Örneği/Ordering Example/Bestellbeispiel

1 ad./pcs./stück ADKT-KG-R-1212-2-R12-K-S



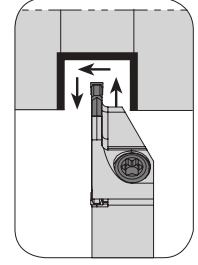
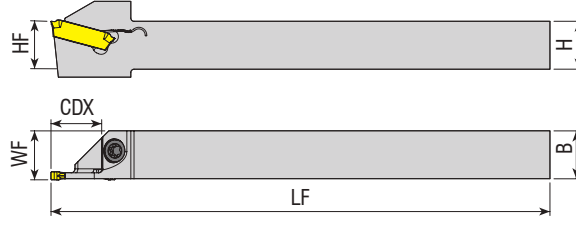

| Takım Kodu<br>Ordering Code<br>Bestell-Bezeichnung | Stok<br>Stock<br>Lager |   | Takım Ölçüleri (mm)<br>Dimension (mm)<br>Abmessung (mm) |    |     |      |     | Kesici Uç<br>Insert<br>Wendeschneidplatte | Yedek Parçaları / Spare Parts / Ersatzteile |                      |  |           |
|--|------------------------|---|---|----|-----|------|-----|---|---|----------------------|--|-----------|
|  | R                      | L | HF=H  | B  | LF  | WF   | CDX |   | Sıkma Vidası<br>Screw<br>Klemmschraube      | Pul<br>Stamp<br>Ring | Tork Anahtar<br>Torx Key<br>Torx Innensechskantschlüssel |           |
| ADKT-WGX16-R/L-1212-2-R12-K-S                      | ●                      | ● | 12  | 12 | 125 | 12.2 | 12  | GX16. - 2                                 | 4015-M4x11                                  | -                    | 80-T15   |           |
| ADKT-WGX16-R/L-1616-2-R16-K-S                      | ●                      | ○ | 16  | 16 | 125 | 16.2 | 16  |   |   |                      |  |           |
| ADKT-WGX24-R/L-1616-3-R16-K-S                      | ●                      | ○ | 16  | 16 | 125 | 16.3 | 16  |   |   |                      |  | GX24. - 3 |

WLTR Ucuna Uygunur. / Compatible with WLTR Insert. / Kompatibel mit WLTR Wendepatten.

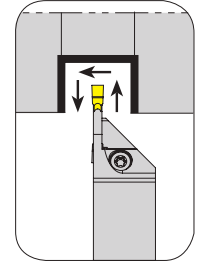
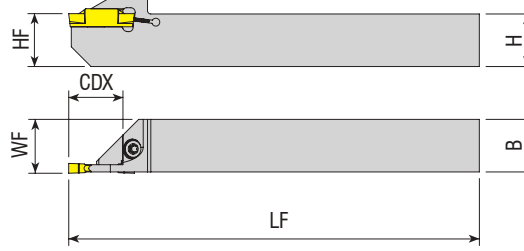

| Takım Kodu<br>Ordering Code<br>Bestell-Bezeichnung | Stok<br>Stock<br>Lager |   | Takım Ölçüleri (mm)<br>Dimension (mm)<br>Abmessung (mm) |    |     |      |     | Kesici Uç<br>Insert<br>Wendeschneidplatte | Yedek Parçaları / Spare Parts / Ersatzteile |                      |  |          |
|--|------------------------|---|---|----|-----|------|-----|---|---|----------------------|--|----------|
|  | R                      | L | HF=H  | B  | LF  | WF   | CDX |   | Sıkma Vidası<br>Screw<br>Klemmschraube      | Pul<br>Stamp<br>Ring | Tork Anahtar<br>Torx Key<br>Torx Innensechskantschlüssel |          |
| ADKT-TG-R/L-1212-2-R12-K-S                         | ●                      | ○ | 12  | 12 | 125 | 12.2 | 12  | DGM2-020                                  | 4015-M4x11                                  | -                    | 80-T15   |          |
| ADKT-TG-R/L-1212-3-R12-K-S                         | ●                      | ○ | 12  | 12 | 125 | 12.3 | 12  |   |   |                      |  | DGM3-020 |

TNGLY Ucuna Uygunur. / Compatible with TNGLY Insert. / Kompatibel mit TNGLY Wendepatten.

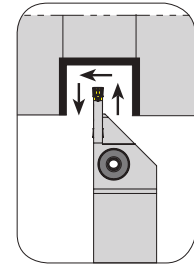
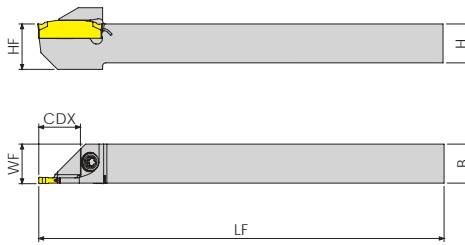
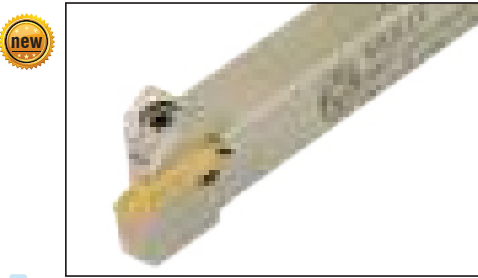

| Takım Kodu<br>Ordering Code<br>Bestell-Bezeichnung | Stok<br>Stock<br>Lager |   | Takım Ölçüleri (mm)<br>Dimension (mm)<br>Abmessung (mm) |    |     |      |     | Kesici Uç<br>Insert<br>Wendeschneidplatte | Yedek Parçaları / Spare Parts / Ersatzteile |                      |  |         |
|--|------------------------|---|---|----|-----|------|-----|---|---|----------------------|--|---------|
|  | R                      | L | HF=H  | B  | LF  | WF   | CDX |   | Sıkma Vidası<br>Screw<br>Klemmschraube      | Pul<br>Stamp<br>Ring | Tork Anahtar<br>Torx Key<br>Torx Innensechskantschlüssel |         |
| ADKT-123-R/L-1212-2-T12-K-S                        | ●                      | ○ | 12  | 12 | 125 | 12.2 | 12  | 123 - 2                                   | 4015-M4x11                                  | -                    | 80-T15   |         |
| ADKT-123-R/L-1212-3-T12-K-S                        | ○                      | ○ | 12  | 12 | 125 | 12.3 | 12  |   |   |                      |  | 123 - 3 |

R: Sağ / Right / Rechts L: Sol / Left / Links  
● Stokta / In Stock / Auf Lager ○ Stokta Yok / Non Stock Item / Kein Lagerartikel, Lieferzeit auf Anfrage  
SNDVK Ucuna Uygunur. / Compatible with SNDVK Insert. / Kompatibel mit SNDVK Wendepatten.

Sipariş Örneği/Ordering Example/Bestellbeispiel  
1 ad./pcs./stück ADKT-WGX16-R-1212-2-R12-K-S

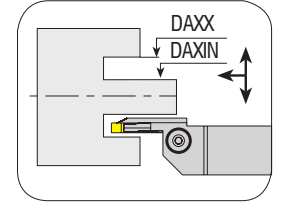
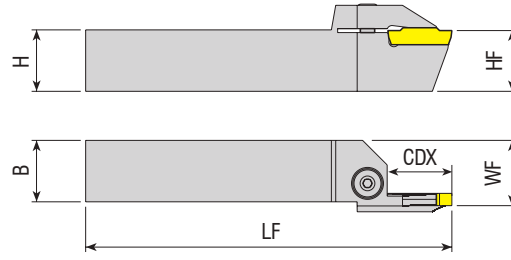

| Takım Kodu<br>Ordering Code<br>Bestell-Bezeichnung | Stok<br>Stock<br>Lager |   | Takım Ölçüleri (mm)<br>Dimension (mm)<br>Abmessung (mm) |    |     |      |     |       |      | Kesici Uç<br>Insert<br>Wendeschneidplatte | Yedek Parçaları / Spare Parts / Ersatzteile |                      |  |
|--|------------------------|---|---|----|-----|------|-----|-------|------|---|---|----------------------|--|
|  | R                      | L | HF=H  | B  | LF  | WF   | CDX | DAXIN | DAXX |   | Sıkma Vidası<br>Screw<br>Klemmschraube      | Pul<br>Stamp<br>Ring | Tork Anahtar<br>Torx Key<br>Torx-Innensechskantschlüssel |
| AAKT-K-R/L-2525-34-45-3-T17                        | ●                      | ● | 25  | 25 | 150 | 26.5 | 17  | 34    | 45   | MGM. - 3                                  |   |                      |  |
| AAKT-K-R/L-2525-39-55-3-T17                        | ●                      | ● | 25  | 25 | 150 | 26.5 | 17  | 39    | 55   |   |   |                      |  |
| AAKT-K-R/L-2525-49-80-3-T17                        | ●                      | ● | 25  | 25 | 150 | 26.5 | 17  | 49    | 80   |   |   |                      |  |
| AAKT-K-R/L-2525-70-110-3-T17                       | ●                      | ● | 25  | 25 | 150 | 26.5 | 17  | 70    | 110  |   |   |                      |  |
| AAKT-K-R/L-2525-100-150-3-T17                      | ●                      | ● | 25  | 25 | 150 | 26.5 | 17  | 100   | 150  |   |   |                      |  |
| AAKT-K-R/L-2525-80-180-3-T32                       | ●                      | ● | 25  | 25 | 150 | 26.5 | 32  | 80    | 180  |   |   |                      |  |
| AAKT-K-R/L-2525-175-215-3-T22                      | ●                      | ● | 25  | 25 | 150 | 26.5 | 22  | 175   | 215  |   |   |                      |  |
| AAKT-K-R/L-2525-700-800-3-T17                      | ●                      | ● | 25  | 25 | 150 | 26.5 | 17  | 700   | 800  |   |   |                      |  |
| AAKT-K-R/L-2525-50-85-4-T22                        | ●                      | ● | 25  | 25 | 150 | 26.5 | 22  | 50    | 85   | MGM. - 4                                  | 2004-M8x1x20                                | -                    | AAL-05-4   |
| AAKT-K-R/L-2525-70-110-4-T22                       | ●                      | ● | 25  | 25 | 150 | 26.5 | 22  | 70    | 110  |   |   |                      |  |
| AAKT-K-R/L-2525-100-150-4-T22                      | ●                      | ● | 25  | 25 | 150 | 26.5 | 22  | 100   | 150  |   |   |                      |  |
| AAKT-K-R/L-2525-80-180-4-T32                       | ●                      | ● | 25  | 25 | 150 | 26.5 | 32  | 80    | 180  |   |   |                      |  |
| AAKT-K-R/L-2525-180-800-4-T32                      | ●                      | ● | 25  | 25 | 150 | 26.5 | 32  | 180   | 800  |   |   |                      |  |
| AAKT-K-R/L-2525-70-110-5-T25                       | ●                      | ● | 25  | 25 | 150 | 26.5 | 25  | 70    | 110  |   |   |                      |  |
| AAKT-K-R/L-2525-100-150-5-T25                      | ●                      | ● | 25  | 25 | 150 | 26.5 | 25  | 100   | 150  |   |   |                      |  |
| AAKT-K-R/L-2525-80-180-5-T32                       | ●                      | ● | 25  | 25 | 150 | 26.5 | 32  | 80    | 180  |   |   |                      |  |
| AAKT-K-R/L-2525-140-200-5-T25                      | ●                      | ● | 25  | 25 | 150 | 26.5 | 25  | 140   | 200  | MGM. - 5                                  |   |                      |  |
| AAKT-K-R/L-2525-180-800-5-T32                      | ●                      | ● | 25  | 25 | 150 | 26.5 | 32  | 180   | 800  |   |   |                      |  |
| AAKT-K-R/L-2525-70-110-5-T25                       | ●                      | ● | 25  | 25 | 150 | 26.5 | 25  | 70    | 110  |   |   |                      |  |
| AAKT-K-R/L-2525-100-150-5-T25                      | ●                      | ● | 25  | 25 | 150 | 26.5 | 25  | 100   | 150  |   |   |                      |  |
| AAKT-K-R/L-2525-80-180-5-T32                       | ●                      | ● | 25  | 25 | 150 | 26.5 | 32  | 80    | 180  |   |   |                      |  |
| AAKT-K-R/L-2525-140-200-5-T25                      | ●                      | ● | 25  | 25 | 150 | 26.5 | 25  | 140   | 200  |   |   |                      |  |
| AAKT-K-R/L-2525-180-800-5-T32                      | ●                      | ● | 25  | 25 | 150 | 26.5 | 32  | 180   | 800  |   |   |                      |  |
| AAKT-K-R/L-2525-180-800-5-T40                      | ●                      | ○ | 25  | 25 | 150 | 26.5 | 40  | 180   | 800  |   |   |                      |  |
| AAKT-K-R/L-2525-60-100-6-T25                       | ●                      | ● | 25  | 25 | 150 | 26.5 | 25  | 60    | 100  | MGM. - 6                                  |   |                      |  |
| AAKT-K-R/L-2525-60-100-6-T35                       | ●                      | ○ | 25  | 25 | 150 | 26.5 | 35  | 60    | 100  |   |   |                      |  |
| AAKT-K-R/L-2525-100-200-6-T25                      | ●                      | ○ | 25  | 25 | 150 | 26.5 | 25  | 100   | 200  |   |   |                      |  |
| AAKT-K-R/L-2525-100-200-6-T35                      | ●                      | ○ | 25  | 25 | 150 | 26.5 | 35  | 100   | 200  |   |   |                      |  |
| AAKT-K-R/L-2525-100-200-6-T45                      | ●                      | ○ | 25  | 25 | 150 | 26.5 | 45  | 100   | 200  |   |   |                      |  |
| AAKT-K-R/L-2525-140-300-6-T35                      | ●                      | ● | 25  | 25 | 150 | 26.5 | 35  | 140   | 300  |   |   |                      |  |
| AAKT-K-R/L-2525-140-300-6-T45                      | ●                      | ○ | 25  | 25 | 150 | 26.5 | 45  | 140   | 300  |   |   |                      |  |
| AAKT-K-R/L-2525-180-360-6-T40                      | ●                      | ○ | 25  | 25 | 150 | 26.5 | 40  | 180   | 360  |   |   |                      |  |
| AAKT-K-R/L-2525-140-300-8-T35                      | ●                      | ○ | 25  | 25 | 150 | 26.5 | 35  | 140   | 300  | MGM. - 8                                  |   |                      |  |
| AAKT-K-R/L-3232-140-350-8-T35                      | ●                      | ○ | 32  | 32 | 150 | 33.5 | 35  | 140   | 350  |   |   |                      |  |

R: Sağ / Right / Rechts L: Sol / Left / Links

● Stokta / In Stock / Auf Lager ○ Stokta Yok / Non Stock Item / Kein Lagerartikel, Lieferzeit auf Anfrage

KRLY Ucuna Uygunudur. / Compatible with KRLY Insert. / Kompatibel mit KRLY Wendeleitern.

Sipariş Örneği/Ordering Example/Bestellbeispiel

1 ad./pcs./stück AAKT-K-R-2525-34-45-3-T17

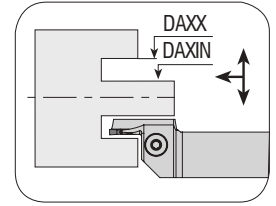
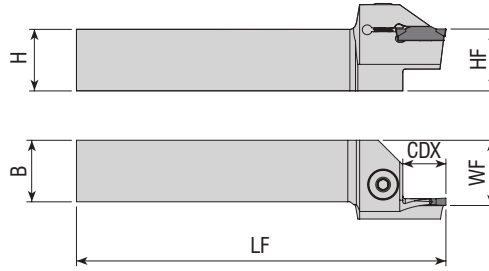

**Takım Kodu**  
**Ordering Code**  
*Bestell-Bezeichnung*

**Takım Ölçüleri (mm)**  
*Dimension (mm)*  
*Abmessung (mm)*

**Kesici Uç**  
*Insert*  
*Wendeschneidplatte*

**Yedek Parçaları / Spare Parts / Ersatzteile**

**Sıkma Vidası**  
*Screw*  
*Klemmschraube*

**Pul**  
*Stamp*  
*Ring*

**Anahtar**  
*Allen Key*  
*Innensechskantschlüssel*

|   | R | L | HF=H | B  | LF  | WF   | CDX | DAXIN | DAXX |          |              |   |          |
|---|---|---|------|----|-----|------|-----|-------|------|----------|--------------|---|----------|
| AAKT-ZCC2-R/L-2525-140-180-2-T4             | ● | ○ | 25   | 25 | 150 | 26.5 | 4   | 140   | 180  | Z.BD - 2 |              |   |          |
| AAKT-ZCC2-R/L-2525-35-45-3-T17              | ● | ● | 25   | 25 | 150 | 26.5 | 17  | 35    | 45   | Z.FD - 3 |              |   |          |
| AAKT-ZCC2-R/L-2525-39-55-3-T17              | ● | ○ | 25   | 25 | 150 | 26.5 | 17  | 39    | 55   |          |              |   |          |
| AAKT-ZCC2-R/L-2525-49-80-3-T17              | ● | ● | 25   | 25 | 150 | 26.5 | 17  | 49    | 80   |          |              |   |          |
| <b>new</b> AAKT-ZCC2-R/L-2525-70-110-3-T15  | ● | ○ | 25   | 25 | 150 | 26.5 | 15  | 70    | 110  |          |              |   |          |
| AAKT-ZCC2-R/L-2525-70-110-3-T17             | ● | ● | 25   | 25 | 150 | 26.5 | 17  | 70    | 110  | Z.GD - 4 | 2004-M8x1x20 | - | AAL-05-4 |
| AAKT-ZCC2-R/L-2525-100-150-3-T17            | ● | ● | 25   | 25 | 150 | 26.5 | 17  | 100   | 150  |          |              |   |          |
| <b>new</b> AAKT-ZCC2-R/L-2525-100-150-3-T22 | ● | ● | 25   | 25 | 150 | 26.5 | 22  | 100   | 150  |          |              |   |          |
| AAKT-ZCC2-R/L-2525-40-60-4-T22              | ● | ○ | 25   | 25 | 150 | 26.5 | 22  | 40    | 60   |          |              |   |          |
| AAKT-ZCC2-R/L-2525-52-80-4-T22              | ● | ● | 25   | 25 | 150 | 26.5 | 22  | 52    | 80   | Z.HD - 5 |              |   |          |
| AAKT-ZCC2-R/L-2525-72-110-4-T22             | ● | ● | 25   | 25 | 150 | 26.5 | 22  | 72    | 110  |          |              |   |          |
| AAKT-ZCC2-R/L-2525-100-150-4-T22            | ● | ● | 25   | 25 | 150 | 26.5 | 22  | 100   | 150  |          |              |   |          |
| AAKT-ZCC2-R/L-2525-140-200-4-T22            | ● | ● | 25   | 25 | 150 | 26.5 | 22  | 140   | 200  |          |              |   |          |
| AAKT-ZCC2-R/L-2525-55-95-5-T25              | ● | ○ | 25   | 25 | 150 | 26.5 | 25  | 55    | 95   | Z.KD - 6 |              |   |          |
| AAKT-ZCC2-R/L-2525-85-140-5-T25             | ● | ● | 25   | 25 | 150 | 26.5 | 25  | 85    | 140  |          |              |   |          |
| AAKT-ZCC2-R/L-2525-130-200-5-T25            | ● | ○ | 25   | 25 | 150 | 26.5 | 25  | 130   | 200  |          |              |   |          |
| AAKT-ZCC2-R/L-2525-190-400-5-T25            | ● | ● | 25   | 25 | 150 | 26.5 | 25  | 190   | 400  |          |              |   |          |
| AAKT-ZCC2-R/L-2525-190-400-5-T35            | ● | ○ | 25   | 25 | 150 | 26.5 | 35  | 190   | 400  |          |              |   |          |
| AAKT-ZCC2-R/L-2525-200-500-5-T17            | ● | ● | 25   | 25 | 150 | 26.5 | 17  | 200   | 500  |          |              |   |          |
| AAKT-ZCC2-R/L-2525-60-110-6-T15             | ● | ○ | 25   | 25 | 150 | 26.5 | 15  | 60    | 110  |          |              |   |          |
| <b>new</b> AAKT-ZCC2-R/L-3232-160-400-6-T25 | ○ | ● | 32   | 32 | 170 | 33.5 | 25  | 160   | 400  |          |              |   |          |

ZCC Ucuna Uygundur. / Compatible with ZCC Insert. / Kompatibel mit ZCC Wendeplatten.

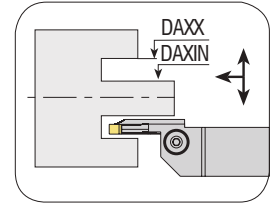
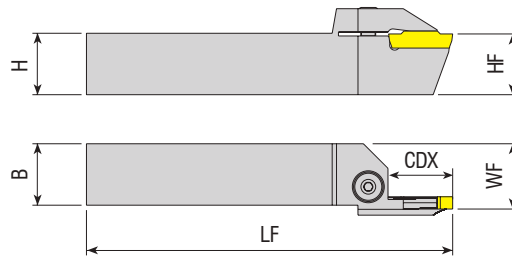

**Takım Kodu**  
**Ordering Code**  
*Bestell-Bezeichnung*

**Stok**  
*Stock*  
*Lager*

**Takım Ölçüleri (mm)**  
*Dimension (mm)*  
*Abmessung (mm)*

**Kesici Uç**  
*Insert*  
*Wendeschneidplatte*

**Yedek Parçaları / Spare Parts / Ersatzteile**

**Sıkma Vidası**  
*Screw*  
*Klemmschraube*

**Pul**  
*Stamp*  
*Ring*

**Anahtar**  
*Allen Key*  
*Innensechskantschlüssel*

|                                | R | L | HF=H | B  | LF  | WF   | CDX | DAXIN | DAXX |         |              |   |          |
|--------------------------------|---|---|------|----|-----|------|-----|-------|------|---------|--------------|---|----------|
| AAKT-KG-R/L-2525-44-70-4-T22   | ○ | ○ | 25   | 25 | 150 | 26.5 | 22  | 44    | 70   | KG. - 4 | 2004-M8x1x20 | - | AAL-05-4 |
| AAKT-KG-R/L-2525-60-120-4-T22  | ○ | ○ | 25   | 25 | 150 | 26.5 | 22  | 60    | 120  |         |              |   |          |
| AAKT-KG-R/L-2525-112-200-4-T22 | ○ | ○ | 25   | 25 | 150 | 26.5 | 22  | 112   | 200  |         |              |   |          |

R: Sağ / Right / Rechts L: Sol / Left / Links

● Stokta / In Stock / Auf Lager ○ Stokta Yok / Non Stock Item / Kein Lagerartikel, Lieferzeit auf Anfrage

KRLY Ucuna Uygundur. / Compatible with KRLY Insert. / Kompatibel mit KRLY Wendeplatten.

Sipariş Örneği/Ordering Example/Bestellbeispiel  
1 ad./pcs./stück AAKT-ZCC2-R-2525-140-180-2-T4

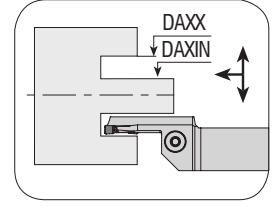
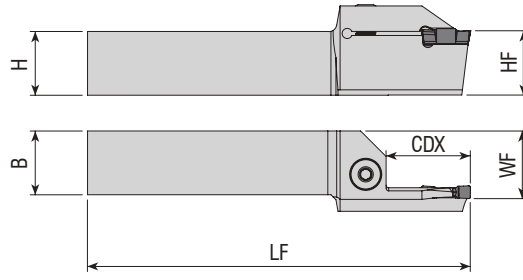

| Takım Kodu<br>Ordering Code<br>Bestell-Bezeichnung | Stok<br>Stock<br>Lager |   | Takım Ölçüleri (mm)<br>Dimension (mm)<br>Abmessung (mm) |    |     |      |     |       |      | Kesici Uç<br>Insert<br>Wendeschneidplatte | Yedek Parçaları / Spare Parts / Ersatzteile |                      |   |  |
|--|------------------------|---|---|----|-----|------|-----|-------|------|---|---|----------------------|---|--|
|  | R                      | L | HF=H  | B  | LF  | WF   | CDX | DAXIN | DAXX |   | Sıkma Vidası<br>Screw<br>Klemmschraube      | Pul<br>Stamp<br>Ring | Anahtar<br>Allen Key<br>Innensechskantschlüssel |  |
| AAKT-IG-R/L-2525-40-60-4-T25                       | ●                      | ● | 25  | 25 | 150 | 26.5 | 25  | 40    | 60   | DGN / GRP - 4                             | 2004-M8x1x20                                | -                    | AAL-05-4  |  |
| AAKT-IG-R/L-2525-52-80-4-T25                       | ●                      | ● | 25  | 25 | 150 | 26.5 | 25  | 52    | 80   |   |   |                      |   |  |
| AAKT-IG-R/L-2525-70-110-4-T28                      | ●                      | ● | 25  | 25 | 150 | 26.5 | 28  | 70    | 110  |   |   |                      |   |  |
| AAKT-IG-R/L-2525-72-110-4-T25                      | ○                      | ○ | 25  | 25 | 150 | 26.5 | 25  | 72    | 110  |   |   |                      |   |  |
| AAKT-IG-R/L-2525-100-150-4-T25                     | ●                      | ○ | 25  | 25 | 150 | 26.5 | 25  | 100   | 150  |   |   |                      |   |  |
| AAKT-IG-R/L-2525-110-200-4-T28                     | ●                      | ○ | 25  | 25 | 150 | 26.5 | 28  | 110   | 200  |   |   |                      |   |  |
| AAKT-IG-R/L-2525-110-200-4-T32                     | ●                      | ● | 25  | 25 | 150 | 26.5 | 32  | 110   | 200  |   |   |                      |   |  |
| AAKT-IG-R/L-2525-140-200-4-T25                     | ○                      | ○ | 25  | 25 | 150 | 26.5 | 25  | 140   | 200  |   |   |                      |   |  |
| AAKT-IG-R/L-2525-180-800-4-T28                     | ●                      | ● | 25  | 25 | 150 | 26.5 | 28  | 180   | 800  |   |   |                      |   |  |
| AAKT-IG-R/L-2525-200-800-4-T25                     | ○                      | ○ | 25  | 25 | 150 | 26.5 | 25  | 200   | 800  |   |   |                      |   |  |
| AAKT-IG-R/L-2525-70-110-5-T32                      | ●                      | ● | 25  | 25 | 150 | 26.5 | 32  | 70    | 110  | DGN / GRP - 5                             | -   | AAL-05-4             |   |  |
| AAKT-IG-R/L-2525-110-200-5-T9                      | ●                      | ○ | 25  | 25 | 150 | 26.5 | 9   | 110   | 200  |   |   |                      |   |  |
| AAKT-IG-R/L-2525-110-200-5-T32                     | ●                      | ● | 25  | 25 | 150 | 26.5 | 32  | 110   | 200  |   |   |                      |   |  |
| AAKT-IG-R/L-2525-180-800-5-T32                     | ●                      | ● | 25  | 25 | 150 | 26.5 | 32  | 180   | 800  | DGN / GRP - 6                             | -   | AAL-05-4             |   |  |
| AAKT-IG-R/L-2525-58-100-6-T32                      | ●                      | ○ | 25  | 25 | 150 | 26.5 | 32  | 58    | 100  |   |   |                      |   |  |
| AAKT-IG-R/L-2525-88-180-6-T32                      | ●                      | ○ | 25  | 25 | 150 | 26.5 | 32  | 88    | 180  |   |   |                      |   |  |

ISCR Ucuna Uygundur. / Compatible with ISCR Insert. / Kompatibel mit ISCR Wendeplatten.

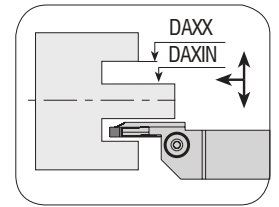
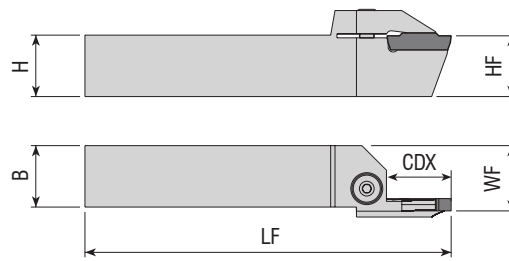

| Takım Kodu<br>Ordering Code<br>Bestell-Bezeichnung | Stok<br>Stock<br>Lager |   | Takım Ölçüleri (mm)<br>Dimension (mm)<br>Abmessung (mm) |    |     |      |     |       |      | Kesici Uç<br>Insert<br>Wendeschneidplatte | Yedek Parçaları / Spare Parts / Ersatzteile |                      |   |  |
|--|------------------------|---|---|----|-----|------|-----|-------|------|---|---|----------------------|---|--|
|  | R                      | L | HF=H  | B  | LF  | WF   | CDX | DAXIN | DAXX |   | Sıkma Vidası<br>Screw<br>Klemmschraube      | Pul<br>Stamp<br>Ring | Anahtar<br>Allen Key<br>Innensechskantschlüssel |  |
| AAKT-SGC-R/L-2020-22-53-3-T13                      | ○                      | ● | 20  | 20 | 125 | 21.5 | 13  | 22    | 53   | GCM N3002<br>GCM N4020                    | 2004-M8X1X20                                | -                    | AAL-05-4  |  |
| AAKT-SGC-R/L-2525-80-100-3-T8                      | ●                      | ○ | 25  | 25 | 150 | 26.5 | 8   | 80    | 100  |   |   |                      |   |  |
| AAKT-SGC-R/L-2525-40-65-4-T12                      | ●                      | ○ | 25  | 25 | 150 | 26.5 | 12  | 40    | 65   |   |   |                      |   |  |
| AAKT-SGC-R/L-2525-80-140-4-T8                      | ●                      | ○ | 25  | 25 | 150 | 26.5 | 8   | 80    | 140  |   |   |                      |   |  |

R: Sağ / Right / Rechts L: Sol / Left / Links

● Stokta / In Stock / Auf Lager ○ Stokta Yok / Non Stock Item / Kein Lagerartikel, Lieferzeit auf Anfrage

SMTM Ucuna Uygundur. / Compatible with SMTM Insert. / Kompatibel mit SMTM Wendeplatten.

Sipariş Örneği/Ordering Example/Bestellbeispiel

1 ad./pcs./stück AAKT-IG-R-2525-40-60-4-T25

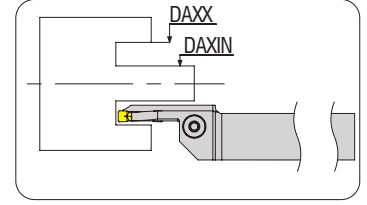
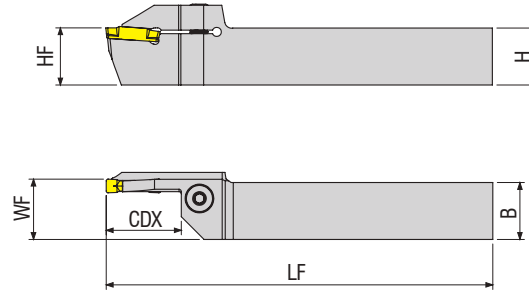
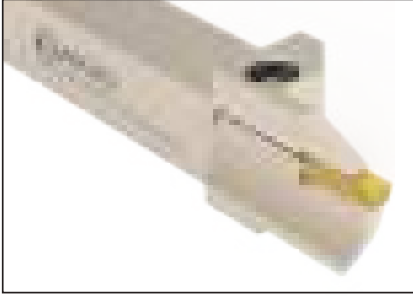

**Takım Kodu**  
**Ordering Code**  
*Bestell-Bezeichnung*

Stok  
Stock  
Lager

Takım Ölçüleri (mm)  
Dimension (mm)  
Abmessung (mm)

Kesici Uç  
Insert  
Wendeschneidplatte

Yedek Parçaları / Spare Parts / Ersatzteile

Sıkma Vidası  
Screw  
Klemmschraube

Pul  
Stamp  
Ring

Anahtar  
Allen Key  
Innensechskantschlüssel

R

L

HF=H

B

LF

WF

CDX

DAXIN

DAXX

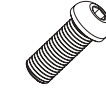

AAKT-WGX24-R-L-2525-58-100-6-T32

● ○

○ ○

25

25

170

26.5

32

58

100

**GX24-6**

2004-M8x1x20

-

AAL-05-4

AAKT-WGX24-R-L-2525-88-180-6-T32

● ○

○ ○

25

25

170

26.5

32

88

180

WLTR Ucuna Uygundur. / Compatible with WLTR Insert. / Kompatibel mit WLTR Wendeplatten.

L TİP ALIN KANAL AÇMA TAKIMLARI  
L TYPE FACE EXTERNAL GROOVING TOOLHOLDERS  
AXIAL-STECHHALTER L-TYPE

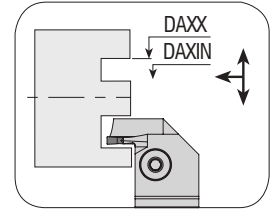
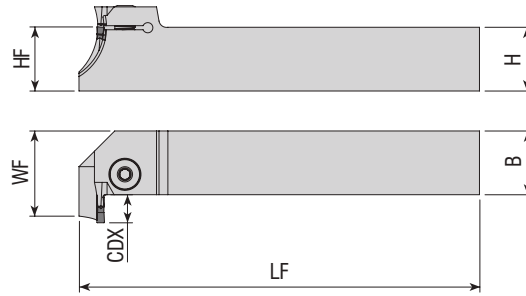

**Takım Kodu**  
**Ordering Code**  
*Bestell-Bezeichnung*

Stok  
Stock  
Lager

Takım Ölçüleri (mm)  
Dimension (mm)  
Abmessung (mm)

Kesici Uç  
Insert  
Wendeschneidplatte

Yedek Parçaları / Spare Parts / Ersatzteile

Sıkma Vidası  
Screw  
Klemmschraube

Pul  
Stamp  
Ring

Anahtar  
Allen Key  
Innensechskantschlüssel

R

L

HF=H

B

LF

WF

CDX

DAXIN

DAXX



ALKT-ZCC2-R/L-2525-35-45-3-T10

● ●

● ●

25

25

150

36

10

35

45

ALKT-ZCC2-R/L-2525-39-55-3-T10

● ●

● ●

25

25

150

36

10

39

55

ALKT-ZCC2-R/L-2525-35-∞-3-T4

● ●

● ●

25

25

150

30

4

35

∞

ALKT-ZCC2-R/L-2525-40-60-4-T14

● ●

● ●

25

25

150

40

14

40

60

ALKT-ZCC2-R/L-2525-52-80-4-T14

● ○

● ○

25

25

150

40

14

52

80

ALKT-ZCC2-R/L-2525-72-110-4-T14

● ○

● ○

25

25

150

40

14

72

110

ALKT-ZCC2-R/L-2525-100-230-4-T14

● ○

● ○

25

25

150

40

14

100

230

ALKT-ZCC2-R/L-2525-40-∞-4-T4

● ●

● ●

25

25

150

30

4

40

∞

**Z.FD - 3**

**Z.GD - 4**

2004-M8x1x20

-

AAL-05-4

R: Sağ / Right / Rechts L: Sol / Left / Links

● Stokta / In Stock / Auf Lager ○ Stokta Yok / Non Stock Item / Kein Lagerartikel, Lieferzeit auf Anfrage

ZCC Ucuna Uygundur. / Compatible with ZCC Insert. / Kompatibel mit ZCC Wendeplatten.

Sipariş Örneği/Ordering Example/Bestellbeispiel

1 ad./pcs./stück AAKT-WGX24-R-2525-58-100-6-T32

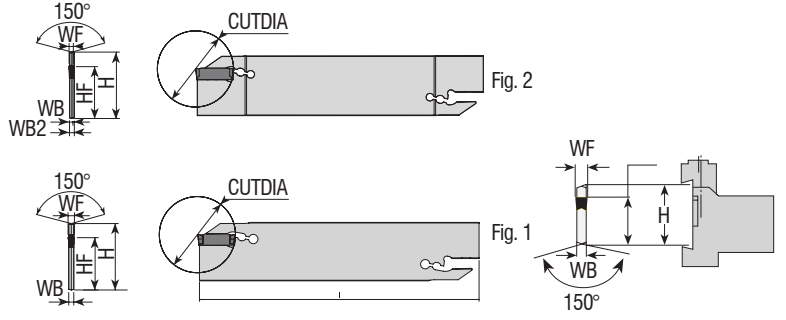

| Takım Kodu<br>Ordering Code<br>Bestell-Bezeichnung | Stok<br>Stock<br>Lager | Takım Ölçüleri (mm)<br>Dimension (mm)<br>Abmessung (mm) |    |      |    |     |      |        |      | Kesici Uç<br>Insert<br>Wendeschneidplatte | Yedek Parçaları / Spare Parts<br>Ersatzteile |
|--|------------------------|---|----|------|----|-----|------|--------|------|---|--|
|  |                        | H   | WF | WB2  | WB | I   | HF   | CUTDIA | Fig. |   |  |
| AKL-SGC-26-3                                       | ●                      | 26  | 3  | 2.40 | -  | 110 | 21.4 | 39     | 2    | GCM N30                                   | ALA-02                                       |
| AKL-SGC-32-3                                       | ●                      | 32  | 3  | 2.40 | -  | 150 | 25   | 39     | 1    |   |  |

SMTM Ucuna Uygunur. / Compatible with SMTM Insert. / Kompatibel mit SMTM Wendeleplatten.

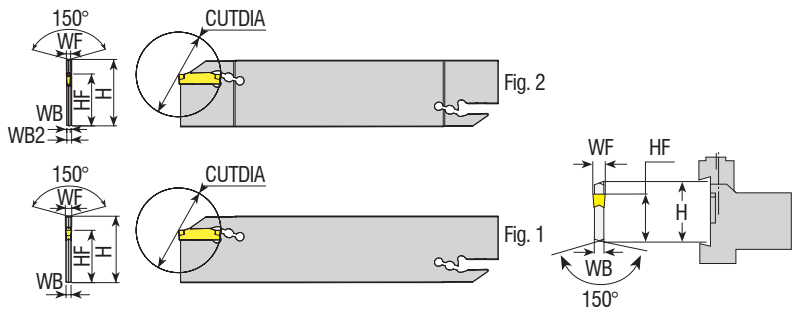

| Takım Kodu<br>Ordering Code<br>Bestell-Bezeichnung | Stok<br>Stock<br>Lager | Takım Ölçüleri (mm)<br>Dimension (mm)<br>Abmessung (mm) |    |     |      |     |    |        |      | Kesici Uç<br>Insert<br>Wendeschneidplatte | Yedek Parçaları / Spare Parts<br>Ersatzteile |
|--|------------------------|---|----|-----|------|-----|----|--------|------|---|--|
|  |                        | H   | WF | WB2 | WB   | I   | HF | CUTDIA | Fig. |   |  |
| AKL-TD-32-2  | ●                      | 32  | 2  | 2.4 | 1.6  | 150 | 25 | 39     | 2    | TD. - 2                                   | ALA-02                                       |
| ✎ AKL-TD-26-3                                      | ●                      | 26  | 3  | -   | 2.40 | 150 | 26 | 40     | 1    | TD. - 3                                   |  |
| AKL-TD-32-3  | ●                      | 32  | 3  | 2.4 | -    | 150 | 25 | 39     | 1    | TD. - 4                                   |  |
| ✎ AKL-TD-26-4                                      | ●                      | 26  | 4  | -   | 3.20 | 150 | 26 | 40     | 1    | TD. - 5                                   |  |
| ✎ AKL-TD-32-5                                      | ●                      | 32  | 5  | -   | 4    | 150 | 25 | 40     | 1    |   |  |

R: Sağ / Right / Rechts L: Sol / Left / Links  
 ● Stokta / In Stock / Auf Lager ○ Stokta Yok / Non Stock Item / Kein Lagerartikel, Lieferzeit auf Anfrage  
 TGTC Ucuna Uygunur. / Compatible with TGTC Insert. / Kompatibel mit TGTC Wendeleplatten.

Sipariş Örneği/Ordering Example/Bestellbeispiel  
 1 ad./pcs./stück AKL-SGC-26-3

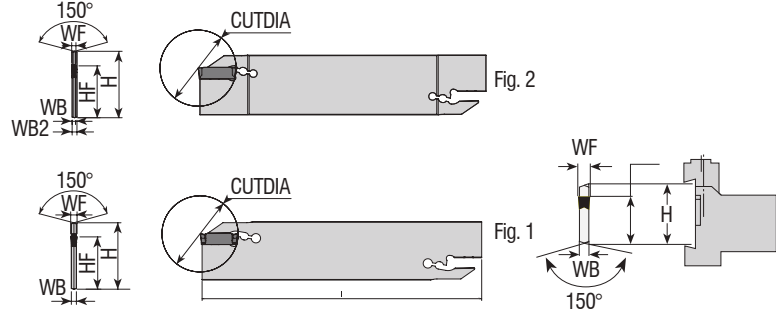

| Takım Kodu<br>Ordering Code<br>Bestell-Bezeichnung | Stok<br>Stock<br>Lager | Takım Ölçüleri (mm)<br>Dimension (mm)<br>Abmessung (mm) |         |     |     |     |      |        |      | Kesici Uç<br>Insert<br>Wendeschneidplatte | Yedek Parçaları / Spare Parts<br>Ersatzteile    |  |
|--|------------------------|---|---------|-----|-----|-----|------|--------|------|---|---|--|
|  |                        | H   | WF      | WB2 | WB  | I   | HF   | CUTDIA | Fig. |   | Anahtar<br>Allen Key<br>Innensechskantschlüssel |  |
| AKL-I-26-2   | ●                      | 26  | 1.9-2.5 | 1.6 | -   | 110 | 21.4 | 39     | 1    | DGN - 2                                   | ALA-02  |  |
| AKL-I-32-2   | ●                      | 32  | 1.9-2.5 | 1.6 | 2.4 | 150 | 25   | 39     | 2    |   |   |  |
| AKL-I-26-3   | ●                      | 26  | 3-3.18  | 2.4 | -   | 110 | 21.4 | 39     | 1    | DGN - 3                                   | ALA-02  |  |
| AKL-I-32-3   | ●                      | 32  | 3-3.18  | 2.4 | -   | 150 | 25   | 39     | 1    |   |   |  |
| AKL-I-26-4   | ●                      | 26  | 4       | 3.2 | -   | 110 | 21.4 | 80     | 1    | DGN / GRP - 4                             | ALA-02  |  |
| AKL-I-32-4   | ●                      | 32  | 4       | 3.2 | -   | 150 | 25   | 100    | 1    |   |   |  |

ISCR Ucuna Uygun. / Compatible with ISCR Insert. / Kompatibel mit ISCR Wendepplatten.

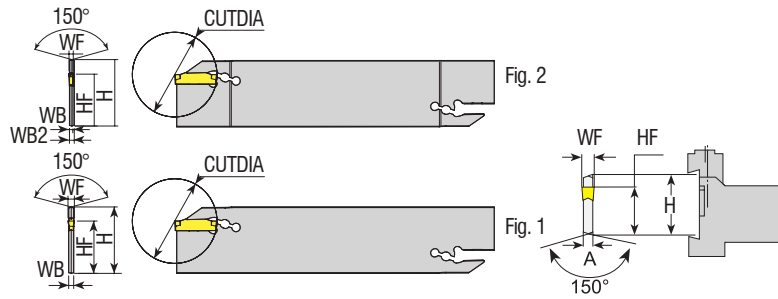

| Takım Kodu<br>Ordering Code<br>Bestell-Bezeichnung | Stok<br>Stock<br>Lager | Takım Ölçüleri (mm)<br>Dimension (mm)<br>Abmessung (mm) |    |     |     |     |    |        |      | Kesici Uç<br>Insert<br>Wendeschneidplatte | Yedek Parçaları / Spare Parts<br>Ersatzteile    |  |
|--|------------------------|---|----|-----|-----|-----|----|--------|------|---|---|--|
|  |                        | H   | WF | WB2 | WB  | I   | HF | CUTDIA | Fig. |   | Anahtar<br>Allen Key<br>Innensechskantschlüssel |  |
| AKL-123-32-2                                       | ●                      | 32  | 2  | 2.4 | 1.6 | 150 | 25 | 39     | 2    | 123 - 2<br>123 - 3<br>123 - 4             | ALA-02  |  |
| AKL-123-32-3                                       | ●                      | 32  | 3  | 2.4 | -   | 150 | 25 | 39     | 1    |   |   |  |
| AKL-123-32-4                                       | ●                      | 32  | 4  | 3.2 | -   | 150 | 25 | 39     | 1    |   |   |  |

R: Sağ / Right / Rechts L: Sol / Left / Links

● Stokta / In Stock / Auf Lager ○ Stokta Yok / Non Stock Item / Kein Lagerartikel, Lieferzeit auf Anfrage  
SNDVK Ucuna Uygun. / Compatible with SNDVK Insert. / Kompatibel mit SNDVK Wendepplatten.

Sipariş Örneği/Ordering Example/Bestellbeispiel  
1 ad./pcs./stück AKL-I-26-2

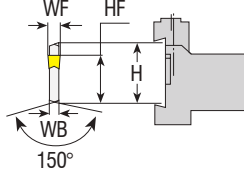
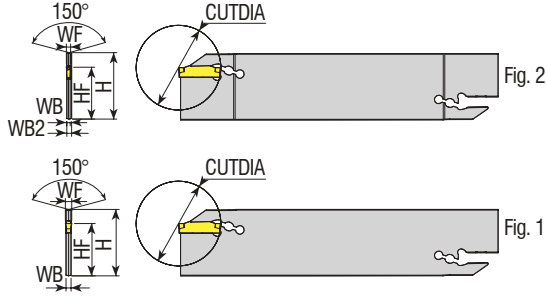

| Takım Kodu<br>Ordering Code<br>Bestell-Bezeichnung | Stok<br>Stock<br>Lager | Takım Ölçüleri (mm)<br>Dimension (mm)<br>Abmessung (mm) |    |     |      |     |    |        |      | Kesici Uç<br>Insert<br>Wendeschneidplatte | Yedek Parçaları / Spare Parts<br>Ersatzteile    |  |
|--|------------------------|---|----|-----|------|-----|----|--------|------|---|---|--|
|  |                        | H   | WF | WB2 | WB   | I   | HF | CUTDIA | Fig. |   | Anahtar<br>Allen Key<br>Innensechskantschlüssel |  |
| AKL-ZCC2-32-3                                      | ●                      | 32  | 3  | -   | 2.40 | 150 | 25 | 39     | 1    |   | ALA-02  |  |
| AKL-ZCC2-32-4                                      | ●                      | 32  | 4  | -   | 3.20 | 150 | 25 | 50.8   | 1    |   |   |  |
| AKL-ZCC2-32-5                                      | ●                      | 32  | 5  | -   | 4    | 150 | 25 | 50.8   | 1    |   |   |  |

ZCC Ucuna Uygundur. / Compatible with ZCC Insert. / Kompatibel mit ZCC Wendepfatten.

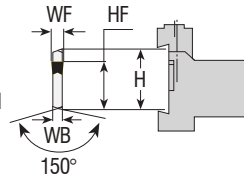
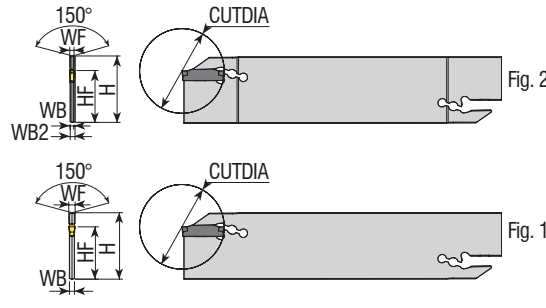

| Takım Kodu<br>Ordering Code<br>Bestell-Bezeichnung | Stok<br>Stock<br>Lager | Takım Ölçüleri (mm)<br>Dimension (mm)<br>Abmessung (mm) |    |      |      |     |    |        |      | Kesici Uç<br>Insert<br>Wendeschneidplatte | Yedek Parçaları / Spare Parts<br>Ersatzteile    |  |
|--|------------------------|---|----|------|------|-----|----|--------|------|---|---|--|
|  |                        | H   | WF | WB2  | WB   | I   | HF | CUTDIA | Fig. |   | Anahtar<br>Allen Key<br>Innensechskantschlüssel |  |
| AKL-K-32-2   | ●                      | 32  | 2  | 2.40 | 1.60 | 150 | 25 | 32     | 2    |   | ALA-02  |  |
| AKL-K-32-3   | ●                      | 32  | 3  | -    | 2.40 | 150 | 25 | 42     | 1    |   |   |  |
| AKL-K-32-4   | ●                      | 32  | 4  | -    | 3.20 | 150 | 25 | 42     | 1    |   |   |  |

R: Sağ / Right / Rechts L: Sol / Left / Links  
 ● Stokta / In Stock / Auf Lager ○ Stokta Yok / Non Stock Item / Kein Lagerartikel, Lieferzeit auf Anfrage  
 KRLY Ucuna Uygundur. / Compatible with KRLY Insert. / Kompatibel mit KRLY Wendepfatten.

Sipariş Örneği/Ordering Example/Bestellbeispiel  
 1 ad./pcs./stück AKL-ZCC2-32-3





new

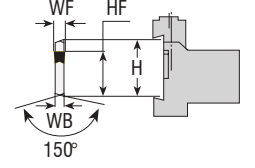
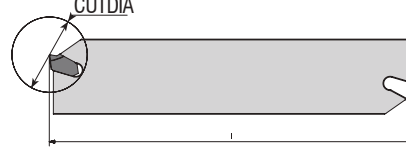
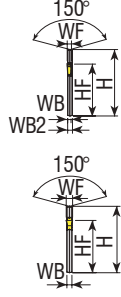

| Takım Kodu<br>Ordering Code<br>Bestell-Bezeichnung | Stok<br>Stock<br>Lager | Takım Ölçüleri (mm)<br>Dimension (mm)<br>Abmessung (mm) |    |     |      |     |    |        |      | Kesici Uç<br>Insert<br>Wendeschneidplatte | Yedek Parçaları / Spare Parts<br>Ersatzteile    |
|--|------------------------|---|----|-----|------|-----|----|--------|------|---|---|
|  |                        | H   | WF | WB2 | WB   | I   | HF | CUTDIA | Fig. |   | Anahtar<br>Allen Key<br>Innensechskantschlüssel |
| AKL-SP-26-2  | ●                      | 26  | 2  | -   | 1.60 | 150 | 21 | -      | 1    | SP200N                                    | ALA-03  |
| AKL-SP-26-3  | ●                      | 26  | 3  | -   | 2.40 | 150 | 21 | -      | 1    | SP300N                                    |   |
| AKL-SP-32-3  | ●                      | 32  | 3  | -   | 2.40 | 150 | 25 | -      | 1    | SP300N                                    |   |
| AKL-SP-32-4  | ●                      | 32  | 4  | -   | 3.20 | 150 | 25 | -      | 1    | SP400N                                    |   |

KRLY Ucuna Uygundur. / Compatible with KRLY Insert. / Kompatibel mit KRLY Wendepfatten.

new

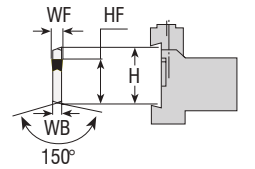
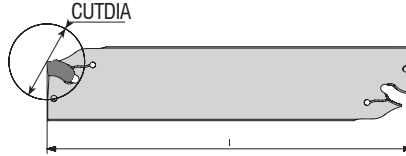
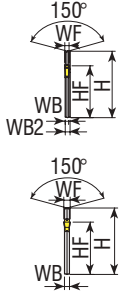

| Takım Kodu<br>Ordering Code<br>Bestell-Bezeichnung | Stok<br>Stock<br>Lager | Takım Ölçüleri (mm)<br>Dimension (mm)<br>Abmessung (mm) |    |     |      |     |       |        |      | Kesici Uç<br>Insert<br>Wendeschneidplatte | Yedek Parçaları / Spare Parts<br>Ersatzteile    |
|--|------------------------|---|----|-----|------|-----|-------|--------|------|---|---|
|  |                        | H   | WF | WB2 | WB   | I   | HF    | CUTDIA | Fig. |   | Anahtar<br>Allen Key<br>Innensechskantschlüssel |
| AKL-SX-32-3  | ●                      | 32  | 3  | -   | 2.40 | 150 | 24.50 | -      | 2    | SX-3E.300N                                | ALA-04  |
| AKL-SX-32-4  | ●                      | 32  | 4  | -   | 3.40 | 150 | 24.50 | -      | 2    | SX-4E.400N                                |   |
| AKL-SX-32-5  | ●                      | 32  | 5  | -   | 4.30 | 150 | 24.40 | -      | 2    | SX-5E.500N                                |   |
| AKL-SX-32-6  | ●                      | 32  | 6  | -   | 5.30 | 150 | 24.30 | -      | 2    | SX-5E.600N                                |   |

R: Sağ / Right / Rechts L: Sol / Left / Links

● Stokta / In Stock / Auf Lager ○ Stokta Yok / Non Stock Item / Kein Lagerartikel, Lieferzeit auf Anfrage  
WLTR Ucuna Uygundur. / Compatible with WLTR Insert. / Kompatibel mit WLTR Wendepfatten.

Sipariş Örneği / Ordering Example / Bestellbeispiel

1 ad./pcs./stück AKL-SP-26-2

➤ **KESME VE DERİN KANAL AÇMA LAMA BLOĞU**  
**BLOCKS FOR PARTING AND DEEP GROOVING BLADES**  
**SPANNBLOCK FÜR STECHSCHWERT**

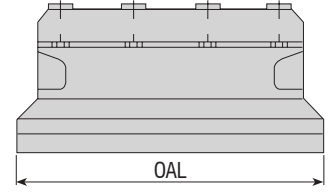
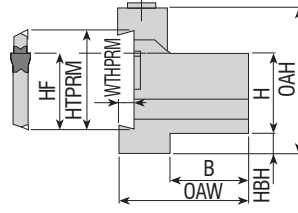

| Takım Kodu<br>Ordering Code<br>Bestell-Bezeichnung | Stok<br>Stock<br>Lager | Takım Ölçüleri (mm)<br>Dimension (mm)<br>Abmessung (mm) |      |    |     |     |        |     |    |     | Yedek Parçaları / Spare Parts / Ersatzteile |  |   |
|--|------------------------|---|------|----|-----|-----|--------|-----|----|-----|---|--|---|
|  |                        | HTPRM   | HF   | H  | HBH | OAH | WTHPRM | OAL | B  | OAW | Pabuç<br>Clamp<br>Spannspratze              | Pabuç Vidası<br>Clamp Screw<br>Klemmschraube | Anahtar<br>Allen Key<br>Innensechskantschlüssel |
| ALBU-20-26   | ●                      | 26  | 21.4 | 20 | 9   | 43  | 4      | 86  | 19 | 38  | ABK-01                                      | 2505-M6x25                                   | AAL-07-5  |
| ALBU-25-26   | ●                      | 26  | 21.4 | 25 | 5   | 45  | 4      | 110 | 23 | 42  | ABK-02                                      | 2505-M6x30                                   |   |
| ALBU-20-32   | ●                      | 32  | 25   | 20 | 13  | 50  | 5.3    | 100 | 19 | 38  | ABK-03                                      |  |   |
| ALBU-25-32   | ●                      | 32  | 25   | 25 | 8   | 50  | 5.3    | 110 | 23 | 42  | ABK-04                                      |  |   |
| ALBU-32-32   | ●                      | 32  | 25   | 32 | 5   | 54  | 5.3    | 110 | 29 | 48  |   |  |   |

**İÇTEN SU VERME KANALLI KESME VE DERİN KANAL AÇMA LAMA BLOĞU**  
**BLOCK FOR PARTING&GROOVING TOOLS WITH INTERNAL COOLANT HOLE**  
**BLOCK FÜR TEILUNG&AUSHOLUNG MIT INNEN KÜHLUNG**

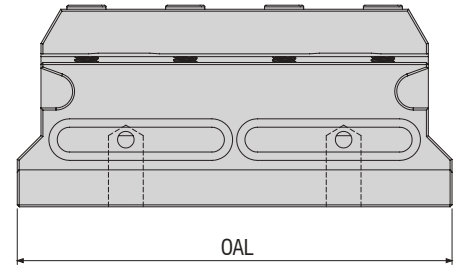
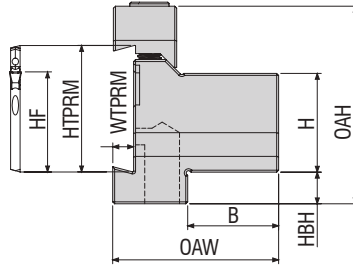

| Takım Kodu<br>Ordering Code<br>Bestell-Bezeichnung | Stok<br>Stock<br>Lager | Takım Ölçüleri (mm)<br>Dimension (mm)<br>Abmessung (mm) |    |    |     |       |        |     |    |     | Yedek Parçaları / Spare Parts / Ersatzteile |  |   |
|--|------------------------|---|----|----|-----|-------|--------|-----|----|-----|---|--|---|
|  |                        | HTPRM   | HD | H  | HBH | AOH   | WTHPRM | OAL | B  | OAW | Pabuç<br>Clamp<br>Spannspratze              | Pabuç Vidası<br>Clamp Screw<br>Klemmschraube | Anahtar<br>Allen Key<br>Innensechskantschlüssel |
| ALBU-20-32-H                                       | ●                      | 32  | 20 | 20 | 13  | 36.50 | 5.30   | 100 | 19 | 38  | ABK-03                                      | 2505-M6x30                                   | AAL-07-5  |
| ALBU-25-32-H                                       | ●                      | 32  | 25 | 25 | 8   | 50    | 5.30   | 110 | 23 | 42  | ABK-01                                      |  |   |
| ALBU-32-32-H                                       | ●                      | 32  | 32 | 32 | 5   | 40.50 | 5.30   | 110 | 29 | 48  | ABK-04                                      |  |   |

R: Sağ / Right / Rechts L: Sol / Left / Links

● Stokta / In Stock / Auf Lager ○ Stokta Yok / Non Stock Item / Kein Lagerartikel, Lieferzeit auf Anfrage

Sipariş Örneği/Ordering Example/Bestellbeispiel  
1 ad./pcs./stück ALBU-20-26

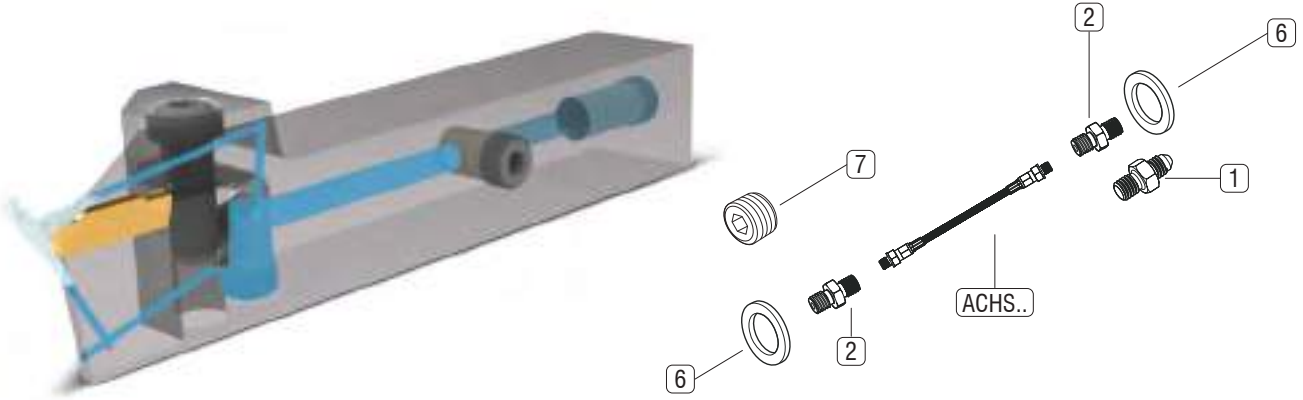

Not: İçten soğutmalı tüm torna katerlerinde kullanılacak 3 tip soğutma hortum setleri tasarlanmıştır. Takımların kullanılmasından önce, kullanılmayan bağlantıların set içindeki vida ile kapatılarak sızdırmazlığın sağlanmasına dikkat edilmelidir. Torna katerlerine yönelik soğutma hortum setleri, ACHS... 10 bar ile maksimum 275 bar basınç aralığında kullanılabilir.

Note: 3 types of cooling hose sets are designed that can be used in all internally cooled lathes. Before using the tools, care should be taken to ensure that the unused connections are closed with the screw in the set and that sealing is ensured. Cooling hose sets for lathe tools can be used in the pressure range of ACHS ... 10 bar to max 275 bar.

Note: Es wurden 3 Arten von Kühlschlauch-Sets entwickelt, die in allen intern gekühlten Drehmaschinen verwendet werden können. Vor der Verwendung der Werkzeuge sollte darauf geachtet werden, dass die nicht verwendeten Verbindungen mit der Schraube im Satz geschlossen werden und die Abdichtung gewährleistet ist. Kühlschlauchsätze für Drehmaschinen können im Druckbereich von ACHS ... 10 bar bis max. 275 bar eingesetzt werden.

| Set İçindeki Parçalar<br>Parts In The Set<br>Teile im Set |                          |   |  | Uzunluk / Length Code / Länge Einstellen: 250         |   |   |
|---|--------------------------|---|--|---|---|---|
|   |                          |   |  | Set Kodu:<br>Set Code:<br>Code Einstellen: ACHS-1-250 | Set Kodu:<br>Set Code:<br>Code Einstellen: ACHS-2-250 | Set Kodu:<br>Set Code:<br>Code Einstellen: ACHS-3-250 |
|   | Resim<br>Picture<br>Bild | Takım Kodu<br>Set Code<br>Code Einstellen | Ürün Açıklaması<br>Product Description<br>Artikelbeschreibung                            |   |   |   |
| 1   |                          | AMP-01                                    | M10 Bağlantı Elemanı<br>M10 Fastener<br>M10 Verschluss                                   | 1x  | -   | -   |
| 2   |                          | AMP-02                                    | G 1/8" Çift Bağlantı Elemanı<br>G 1/8" Double Fastener<br>G 1/8" Doppelverschluss        | 2x  | 1x  | -   |
| 3   |                          | AMP-03                                    | G 1/8" Açılı Bağlantısı<br>G 1/8" Angle Connection<br>G 1/8" Winkelverbindung            | -   | 1x  | 2x  |
| 4   |                          | AMP-04                                    | M10" Açılı Bağlantısı<br>M10" Angle Connection<br>M10" Winkelverbindung                  | -   | 1x  | 1x  |
| 5   |                          | AMP-05                                    | G1/4"-G1/8" Kılcalma Parçası<br>G1/4"-G1/8" Capillary Piece<br>G1/4"-G1/8" Kapillarstück | -   | 1x  | 1x  |
| 6   |                          | AG-01                                     | Bakır Conta<br>Copper Gasket<br>Kupferdichtung   | 2x  | 3x  | 4x  |
| 7   |                          | 2705-G1/8-5.5                             | G1/8" Sızdırmaz Civata<br>G1/8" Sealing Bolt<br>G1/8" Dichtungsschraube                  | 1x  | 1x  | 1x  |
| 8   |                          | AH-1-250                                  | Hortum<br>Hose<br>Schlauch   | 1x  | -   | -   |
| 9   |                          | AH-2-250                                  | Hortum<br>Hose<br>Schlauch   | -   | 1x  | -   |
| 10  |                          | AH-3-250                                  | Hortum<br>Hose<br>Schlauch   | -   | -   | 1x  |

**konusulan**  
**the spoken** kalite...  
**quality...**



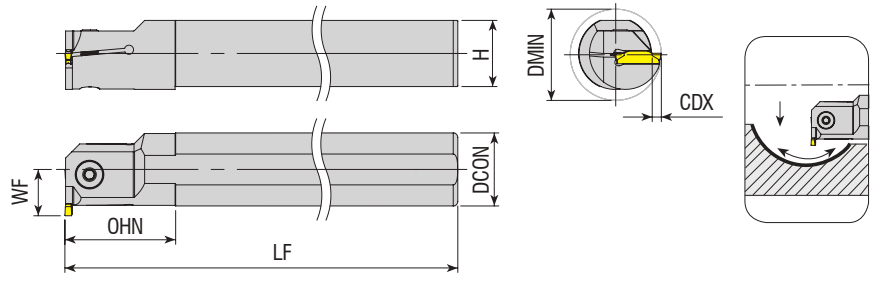

**Takım Kodu**  
**Ordering Code**  
**Bestell-Bezeichnung**

Stok  
Stock  
Lager

Takım Ölçüleri (mm)  
Dimension (mm)  
Abmessung (mm)

Kesici Uç  
Insert  
Wendeschneidplatte

Yedek Parçaları / Spare Parts / Ersatzteile

Sıkma Vidası  
Screw  
Klemmschraube

Anahtar  
Allen Key  
Innensechskantschlüssel

| Takım Kodu<br>Ordering Code<br>Bestell-Bezeichnung | Stok<br>Stock<br>Lager |   | Takım Ölçüleri (mm)<br>Dimension (mm)<br>Abmessung (mm) |      |     |     |     |      |      | Kesici Uç<br>Insert<br>Wendeschneidplatte | Sıkma Vidası<br>Screw<br>Klemmschraube | Anahtar<br>Allen Key<br>Innensechskantschlüssel |
|--|------------------------|---|---|------|-----|-----|-----|------|------|---|--|---|
|  | R                      | L | DCON  | DMIN | LF  | OHN | CDX | H    | WF   |   |  |   |
| AIKT-K-R/L-16-2-T4                                 | ●                      | ● | 16  | 21   | 150 | 28  | 4   | 14.8 | 12   | MGM. - 2                                  | 2503-M4x10                             | AAL-03-3  |
| AIKT-K-R/L-20-2-T4                                 | ●                      | ● | 20  | 25   | 170 | 30  | 4   | 18.3 | 14   |   | 2503-M4x12                             |   |
| AIKT-K-R/L-25-2-T6                                 | ●                      | ● | 25  | 32   | 200 | 40  | 6   | 23   | 18.5 |   | 2504-M5x12                             |   |
| AIKT-K-R/L-20-3-T6                                 | ●                      | ● | 20  | 27   | 170 | 30  | 6   | 18.3 | 16   | MGM. - 3                                  | 2504-M5x12                             | AAL-05-4  |
| AIKT-K-R/L-20-3-T7                                 | ●                      | ● | 20  | 25   | 170 | 38  | 7   | 18.3 | 13   |   | 2504-M5x16                             |   |
| AIKT-K-R/L-25-3-T6                                 | ●                      | ● | 25  | 32   | 200 | 40  | 6   | 23   | 18.5 |   | 2004-M8x1x20                           |   |
| AIKT-K-R/L-25-3-T10                                | ●                      | ● | 25  | 32   | 200 | 48  | 10  | 23   | 17   |   |  |   |
| AIKT-K-R/L-32-3-T6                                 | ●                      | ● | 32  | 39   | 250 | 50  | 6   | 30   | 22   |   |  |   |
| AIKT-K-R/L-32-3-T12                                | ●                      | ● | 32  | 39   | 250 | 53  | 12  | 30   | 22   |   |  |   |
| AIKT-K-R/L-40-3-T6                                 | ●                      | ● | 40  | 47   | 300 | 55  | 6   | 37.5 | 26   |   |  |   |
| AIKT-K-R/L-40-3-T12                                | ●                      | ○ | 40  | 48   | 300 | 63  | 12  | 37.5 | 27   |   |  |   |
| AIKT-K-R/L-20-4-T6                                 | ●                      | ● | 20  | 27   | 170 | 30  | 6   | 18.3 | 16   | MGM. - 4                                  | 2504-M5x12                             | AAL-05-4  |
| AIKT-K-R/L-20-4-T7                                 | ●                      | ○ | 20  | 25   | 170 | 38  | 7   | 18.3 | 13   |   | 2504-M5x16                             |   |
| AIKT-K-R/L-25-4-T6                                 | ●                      | ● | 25  | 32   | 200 | 40  | 6   | 23   | 18.5 |   | 2004-M8x1x20                           |   |
| AIKT-K-R/L-25-4-T10                                | ●                      | ● | 25  | 32   | 200 | 49  | 10  | 23   | 17   |   |  |   |
| AIKT-K-R/L-32-4-T6                                 | ●                      | ● | 32  | 39   | 250 | 50  | 6   | 30   | 22   |   |  |   |
| AIKT-K-R/L-32-4-T12                                | ●                      | ● | 32  | 39   | 250 | 53  | 12  | 30   | 22   |   |  |   |
| AIKT-K-R/L-40-4-T6                                 | ●                      | ● | 40  | 47   | 300 | 55  | 6   | 37.5 | 26   |   |  |   |
| AIKT-K-R/L-40-4-T12                                | ●                      | ● | 40  | 48   | 300 | 63  | 12  | 37.5 | 27   |   |  |   |
| AIKT-K-R/L-25-5-T7                                 | ●                      | ● | 25  | 33   | 200 | 40  | 7   | 23   | 19.5 | MGM. - 5                                  | 2504-M5x16                             | AAL-05-4  |
| AIKT-K-R/L-32-5-T7                                 | ●                      | ● | 32  | 40   | 250 | 50  | 7   | 30   | 23   |   | 2004-M8x1x20                           |   |
| AIKT-K-R/L-40-5-T7                                 | ●                      | ● | 40  | 48   | 300 | 55  | 7   | 37.5 | 27   |   |  |   |
| AIKT-K-R/L-40-5-T12                                | ●                      | ○ | 40  | 48   | 300 | 63  | 12  | 37.5 | 27   |   |  |   |

R: Sağ / Right / Rechts L: Sol / Left / Links

● Stokta / In Stock / Auf Lager ○ Stokta Yok / Non Stock Item / Kein Lagerartikel, Lieferzeit auf Anfrage

KRLY Ucuna Uygunudur. / Compatible with KRLY Insert. / Kompatibel mit KRLY Wendepplatten.

Sipariş Örneği/Ordering Example/Bestellbeispiel

1 ad./pcs./stück AIKT-K-R-16-2-T4

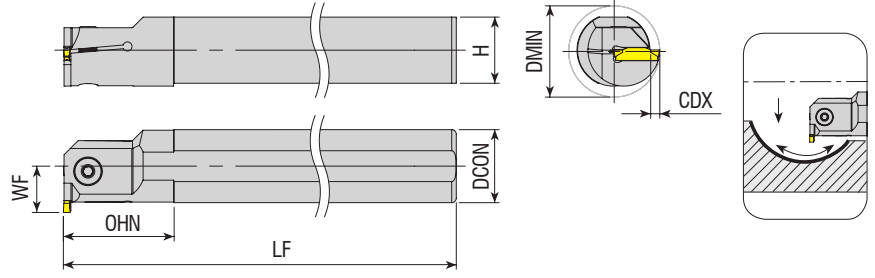

| Takım Kodu<br>Ordering Code<br>Bestell-Bezeichnung | Stok<br>Stock<br>Lager |   | Takım Ölçüleri (mm)<br>Dimension (mm)<br>Abmessung (mm) |      |     |     |     |      |      | Kesici Uç<br>Insert<br>Wendeschneidplatte | Yedek Parçaları / Spare Parts / Ersatzteile |   |
|--|------------------------|---|---|------|-----|-----|-----|------|------|---|---|---|
|  | R                      | L | DCON  | DMIN | LF  | OHN | CDX | H    | WF   |   | Sıkma Vidası<br>Screw<br>Klemmschraube      | Anahtar<br>Allen Key<br>Innensechskantschlüssel |
| AIKT-KG-R/L-25-2-T7                                | ●                      | ● | 25  | 33   | 200 | 40  | 7   | 23   | 19.5 | KG.. - 2                                  | 2504-M5x12                                  | AAL-05-4  |
| AIKT-KG-R/L-20-3-T6.5-H                            | ●                      | ○ | 20  | 27.5 | 170 | 30  | 6.5 | 18.3 | 16.5 |   | 2504-M5x16                                  |   |
| AIKT-KG-R/L-25-3-T7                                | ○                      | ○ | 25  | 33   | 200 | 40  | 7   | 23   | 19.5 | KG.. - 3                                  | 2004-M8x1x20                                |   |
| AIKT-KG-R/L-40-3-T8                                | ●                      | ○ | 40  | 50   | 300 | 55  | 8   | 37.5 | 28   |   | 2504-M5x16                                  |   |
| AIKT-KG-R/L-25-4-T8                                | ●                      | ● | 25  | 34   | 200 | 40  | 8   | 23   | 20.5 | KG.. - 4                                  |   |   |

KRLY Ucuna Uygunur. / Compatible with KRLY Insert. / Kompatibel mit KRYL

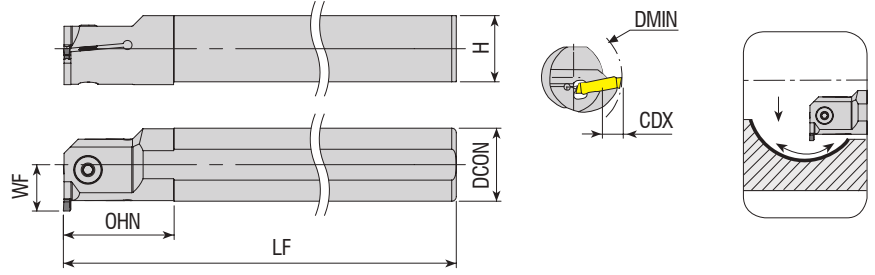

| Takım Kodu<br>Ordering Code<br>Bestell-Bezeichnung | Stok<br>Stock<br>Lager |   | Takım Ölçüleri (mm)<br>Dimension (mm)<br>Abmessung (mm) |      |     |     |     |      |      | Kesici Uç<br>Insert<br>Wendeschneidplatte | Yedek Parçaları / Spare Parts / Ersatzteile |   |
|--|------------------------|---|---|------|-----|-----|-----|------|------|---|---|---|
|  | R                      | L | DCON  | DMIN | LF  | OHN | CDX | H    | WF   |   | Sıkma Vidası<br>Screw<br>Klemmschraube      | Anahtar<br>Allen Key<br>Innensechskantschlüssel |
| AIKT-H-R/L-25-3-T8                                 | ●                      | ● | 25  | 34   | 200 | 40  | 8   | 23   | 20.5 | S229 - 3                                  | 2504-M5x16                                  | AAL-05-4  |
| AIKT-H-R/L-32-3-T7                                 | ●                      | ● | 32  | 40   | 250 | 50  | 7   | 30   | 23   |   | 2004-M8x1x20                                |   |
| AIKT-H-R/L-40-3-T7                                 | ●                      | ● | 40  | 48   | 300 | 55  | 7   | 37.5 | 27   | S229 - 4                                  | 2504-M5x16                                  |   |
| AIKT-H-R/L-25-4-T8                                 | ●                      | ● | 25  | 34   | 200 | 40  | 8   | 23   | 20.5 |   | 2004-M8x1x20                                |   |
| AIKT-H-R/L-32-4-T7                                 | ●                      | ● | 32  | 40   | 250 | 50  | 7   | 30   | 23   | S229 - 5                                  | 2504-M5x16                                  |   |
| AIKT-H-R/L-40-4-T7                                 | ●                      | ● | 40  | 48   | 300 | 55  | 7   | 37.5 | 27   |   | 2004-M8x1x20                                |   |
| AIKT-H-R/L-25-5-T8                                 | ●                      | ● | 25  | 34   | 200 | 40  | 8   | 23   | 20.5 | S229 - 5                                  | 2504-M5x16                                  |   |
| AIKT-H-R/L-32-5-T7                                 | ●                      | ○ | 32  | 40   | 250 | 50  | 7   | 30   | 23   |   | 2004-M8x1x20                                |   |
| AIKT-H-R/L-40-5-T7                                 | ●                      | ○ | 40  | 48   | 300 | 55  | 7   | 37.5 | 27   |   |   |   |

R: Sağ / Right / Rechts L: Sol / Left / Links  
● Stokta / In Stock / Auf Lager ○ Stokta Yok / Non Stock Item / Kein Lagerartikel, Lieferzeit auf Anfrage  
HRN Ucuna Uygunur. / Compatible with HRN Insert. / Kompatibel mit HRN Wendeleisten.

Sipariş Örneği/Ordering Example/Bestellbeispiel  
1 ad./pcs./stück AIKT-KG-R-25-2-T7

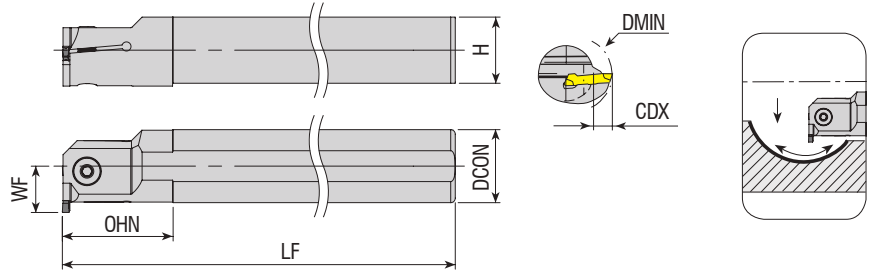

**Takım Kodu**  
**Ordering Code**  
**Bestell-Bezeichnung**

| R | L | DCON | DMIN | LF  | OHN | CDX | H    | WF   | Kesici Uç<br>Insert<br>Wendeschneidplatte | Yedek Parçaları / Spare Parts / Ersatzteile |   |
|---|---|------|------|-----|-----|-----|------|------|---|---|---|
|   |   |      |      |     |     |     |      |      |   | Sıkma Vidası<br>Screw<br>Klemmschraube      | Anahtar<br>Allen Key<br>Innensechskantschlüssel |
| ● | ● | 20   | 26   | 170 | 30  | 6   | 18.3 | 16   | <b>S224 - 2</b>                           | 2503-M4x12                                  | AAL-03-3  |
| ● | ○ | 25   | 32   | 200 | 40  | 6   | 23   | 18.5 |   | 2504-M5x16                                  | AAL-05-4  |
| ● | ○ | 20   | 27   | 170 | 30  | 6   | 18.3 | 16   | <b>S224 - 3</b>                           | 2504-M5x12                                  |   |
| ● | ● | 25   | 32   | 200 | 40  | 6   | 23   | 18.5 |   | 2504-M5x16                                  |   |
| ● | ● | 32   | 39   | 250 | 50  | 6   | 30   | 22   | <b>S224 - 4</b>                           | 2004-M8x1x20                                | AAL-05-4  |
| ● | ○ | 20   | 27   | 170 | 30  | 6   | 18.3 | 16   |   | 2504-M5x12                                  |   |
| ● | ○ | 25   | 32   | 200 | 40  | 6   | 23   | 18.5 | <b>S224 - 4</b>                           | 2504-M5x16                                  | AAL-05-4  |
| ● | ○ | 32   | 39   | 250 | 50  | 6   | 30   | 22   |   | 2004-M8x1x20                                |   |
| ● | ○ | 20   | 26   | 170 | 33  | 5   | 18.3 | 15   | <b>S223 - 2</b>                           | 2503-M4x12                                  | AAL-03-3  |
| ● | ○ | 25   | 31   | 200 | 40  | 5   | 23   | 17.5 |   | 2504-M5x16                                  | AAL-05-4  |
| ● | ○ | 20   | 27   | 170 | 33  | 6   | 18.3 | 16   | <b>S223 - 3</b>                           | 2504-M5x12                                  |   |
| ● | ○ | 25   | 32   | 200 | 40  | 6   | 23   | 18.5 |   | 2504-M5x16                                  |   |

HRN Ucuna Uygundur. / Compatible with HRN Insert. / Kompatibel mit HRN Wendeplatten.

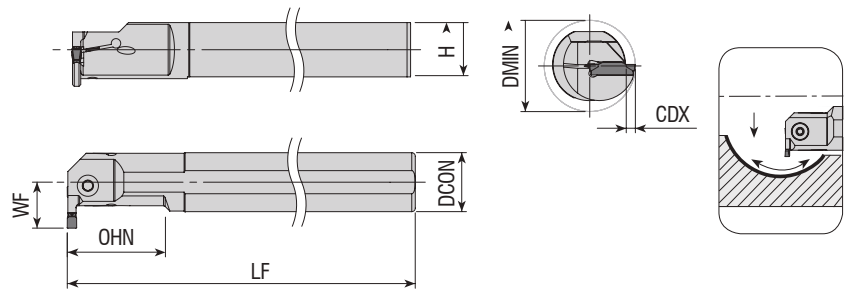

**Takım Kodu**  
**Ordering Code**  
**Bestell-Bezeichnung**

| R | L | DCON | DMIN | LF  | OHN | CDX  | H    | WF | Kesici Uç<br>Insert<br>Wendeschneidplatte | Yedek Parçaları / Spare Parts / Ersatzteile |   |
|---|---|------|------|-----|-----|------|------|----|---|---|---|
|   |   |      |      |     |     |      |      |    |   | Sıkma Vidası<br>Screw<br>Klemmschraube      | Anahtar<br>Allen Key<br>Innensechskantschlüssel |
| ● | ● | 20   | 25   | 170 | 40  | 7    | 18.3 | 13 | <b>A4. - 2</b>                            | 2503-M4x12                                  | AAL-03-3  |
| ● | ○ | 20   | 25   | 170 | 40  | 7    | 18.3 | 13 |   | 2504-M5x12                                  | AAL-05-4  |
| ● | ● | 25   | 32   | 200 | 50  | 10   | 23   | 17 | <b>A4. - 3</b>                            | 2505-M6x16                                  | AAL-07-5  |
| ● | ● | 32   | 40   | 250 | 64  | 12   | 30   | 22 |   | 2505-M6x20                                  |   |
| ● | ○ | 20   | 25   | 170 | 40  | 7    | 18.3 | 13 | <b>A4. - 4</b>                            | 2504-M5x12                                  | AAL-05-4  |
| ● | ○ | 32   | 40   | 190 | 104 | 12.2 | 31   | 22 |   | 2504-M5x14                                  |   |

R: Sağ / Right / Rechts L: Sol / Left / Links

● Stokta / In Stock / Auf Lager ○ Stokta Yok / Non Stock Item / Kein Lagerartikel, Lieferzeit auf Anfrage  
KNMTL Ucuna Uygundur. / Compatible with KNMTL Insert. / Kompatibel mit KNMTL Wendeplatten.

Sipariş Örneği/Ordering Example/Bestellbeispiel

1 ad./pcs./stück AIKT-HK-R-20-2-T6

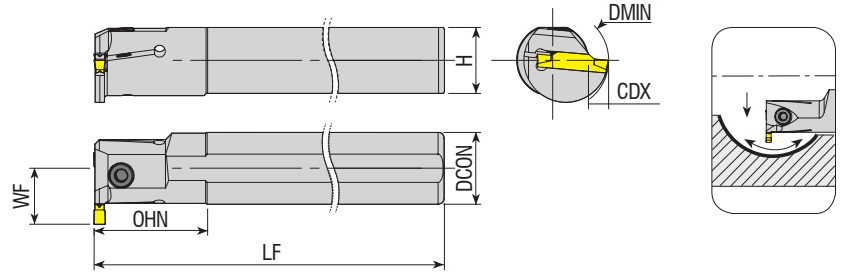

| Takım Kodu<br>Ordering Code<br>Bestell-Bezeichnung | Stok<br>Stock<br>Lager |   | Takım Ölçüleri (mm)<br>Dimension (mm)<br>Abmessung (mm) |      |     |     |     |      |      | Kesici Uç<br>Insert<br>Wendeschneidplatte | Yedek Parçaları / Spare Parts / Ersatzteile |   |
|--|------------------------|---|---|------|-----|-----|-----|------|------|---|---|---|
|  | R                      | L | DCON  | DMIN | LF  | OHN | CDX | H    | WF   |   | Sıkma Vidası<br>Screw<br>Klemmschraube      | Anahtar<br>Allen Key<br>Innensechskantschlüssel |
| AIKT-123-R/L-20-2-T6                               | ●                      | ○ | 20  | 32   | 170 | 30  | 6   | 18.3 | 16   | 123 - 2                                   | 2503-M4x12                                  | AAL-03-3  |
| AIKT-123-R/L-25-2-T6                               | ●                      | ○ | 25  | 32   | 200 | 40  | 6   | 18.3 | 18.5 |   | 2504-M5x12                                  |   |
| AIKT-123-R/L-32-2-T7                               | ●                      | ○ | 32  | 41   | 250 | 45  | 7   | 30   | 23   |   | 2004-M8x1x20                                |   |
| AIKT-123-R/L-20-3-T6                               | ●                      | ○ | 20  | 32   | 170 | 30  | 6   | 18.3 | 16   | 123 - 3                                   | 2504-M5x16                                  | AAL-05-4  |
| AIKT-123-R/L-25-3-T7                               | ●                      | ○ | 25  | 32   | 200 | 40  | 7   | 23   | 19.5 |   | 2004-M8x1x20                                |   |
| AIKT-123-R/L-32-3-T9                               | ●                      | ○ | 32  | 41   | 250 | 50  | 9   | 30   | 25   |   | 2504-M5x16                                  |   |
| AIKT-123-R/L-20-4-T8                               | ●                      | ○ | 20  | 29   | 170 | 30  | 8   | 18.3 | 18   | 123 - 4                                   | 2004-M8x1x20                                |   |
| AIKT-123-R/L-25-4-T7                               | ●                      | ○ | 25  | 32   | 200 | 40  | 7   | 23   | 19.5 |   | 2504-M5x16                                  |   |
| AIKT-123-R/L-32-4-T7                               | ●                      | ● | 32  | 41   | 250 | 45  | 7   | 30   | 23   |   | 2004-M8x1x20                                |   |
| AIKT-123-R/L-32-4-T10                              | ●                      | ○ | 32  | 43   | 250 | 50  | 10  | 30   | 26   | 123 - 5                                   | 2504-M5x16                                  |   |
| AIKT-123-R/L-25-5-T8                               | ●                      | ○ | 25  | 34   | 200 | 40  | 8   | 23   | 20.5 |   | 2004-M8x1x20                                |   |
| AIKT-123-R/L-32-5-T11                              | ●                      | ● | 32  | 43   | 250 | 50  | 11  | 30   | 27   |   | 2504-M5x16                                  |   |

SNDVK Ucuna Uygundur. / Compatible with SNDVK Insert. / Kompatibel mit SNDVK Wendeplatten.

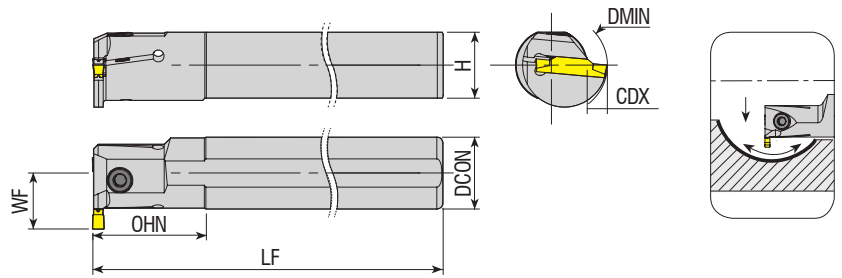

| Takım Kodu<br>Ordering Code<br>Bestell-Bezeichnung | Stok<br>Stock<br>Lager |   | Takım Ölçüleri (mm)<br>Dimension (mm)<br>Abmessung (mm) |      |     |     |     |      |      | Kesici Uç<br>Insert<br>Wendeschneidplatte | Yedek Parçaları / Spare Parts / Ersatzteile |   |
|--|------------------------|---|---|------|-----|-----|-----|------|------|---|---|---|
|  | R                      | L | DCON  | DMIN | LF  | OHN | CDX | H    | WF   |   | Sıkma Vidası<br>Screw<br>Klemmschraube      | Anahtar<br>Allen Key<br>Innensechskantschlüssel |
| AIKT-151.23-R/L-20-2-T6                            | ●                      | ○ | 20  | 32   | 170 | 30  | 6   | 18.3 | 16   | 151.23 - 2                                | 2503-M4x12                                  | AAL-03-3  |
| AIKT-151.23-R/L-20-2.5-T6                          | ●                      | ○ | 20  | 32   | 170 | 30  | 6   | 18.3 | 16   | 151.23 - 2.5                              |   |   |
| AIKT-151.22-R/L-25-3-T6                            | ○                      | ● | 25  | 37   | 200 | 32  | 6   | 23   | 18.5 | 151.23 - 3                                |   |   |
| AIKT-151.22-R/L-25-3-T6-H                          | ○                      | ● | 25  | 37   | 200 | 32  | 6   | 23   | 18.5 |   |   |   |

R: Sağ / Right / Rechts L: Sol / Left / Links

● Stokta / In Stock / Auf Lager ○ Stokta Yok / Non Stock Item / Kein Lagerartikel, Lieferzeit auf Anfrage  
SNDVK Ucuna Uygundur. / Compatible with SNDVK Insert. / Kompatibel mit SNDVK Wendeplatten.

Sipariş Örneği/Ordering Example/Bestellbeispiel  
1 ad./pcs./stück AIKT-123-R-20-2-T6



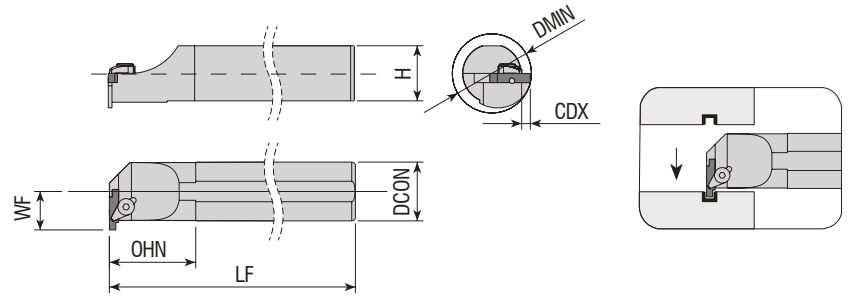

| Takım Kodu<br>Ordering Code<br>Bestell-Bezeichnung | Stok<br>Stock<br>Lager |   | Takım Ölçüleri (mm)<br>Dimension (mm)<br>Abmessung (mm) |      |     |     |     |      |      | Kesici Uç<br>Insert<br>Wendeschneidplatte | Yedek Parçaları / Spare Parts / Ersatzteile |  |                     |   |
|--|------------------------|---|---|------|-----|-----|-----|------|------|---|---|--|---------------------|---|
|  | R                      | L | DCON  | DMIN | LF  | OHN | CDX | H    | WF   |   | Baskı Parçası<br>Wedge Clamp<br>Spannpratze | Sıkma Vidası<br>Screw<br>Klemmschraube | Pim<br>Pin<br>Stift | Anahtar<br>Allen Key<br>Innensechskantschlüssel |
| AIKT-154.91-R/L-16-3-T3                            | ●                      | ● | 16  | 20   | 150 | 35  | 3   | 14.8 | 11   | 154.91 - 3                                | ACK-06                                      | AKV-10-M6x14                           | APM-06              | AAL-05-4  |
| AIKT-154.91-R/L-20-3-T4                            | ●                      | ● | 20  | 25   | 170 | 38  | 4   | 18.3 | 14   |   |   |  |                     |   |
| AIKT-154.91-R/L-25-3-T4                            | ●                      | ● | 25  | 31   | 200 | 40  | 4   | 23   | 16.5 | 154.91 - 5                                | ACK-03                                      | AKV-21-M6x18                           | AAL-03-3            |   |
| AIKT-154.91-R/L-25-5-T5                            | ●                      | ● | 25  | 31   | 200 | 45  | 5   | 23   | 17.5 |   |   |  |                     |   |
| AIKT-154.91-R/L-32-5-T5                            | ●                      | ● | 32  | 38   | 250 | 50  | 5   | 30   | 21   |   |   |  |                     |   |

SNDVK Ucuna Uygundur. / Compatible with SNDVK Insert. / Kompatibel mit SNDVK Wendeplatten.

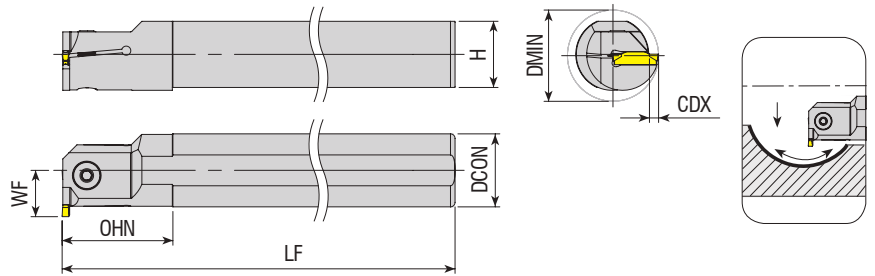

| Takım Kodu<br>Ordering Code<br>Bestell-Bezeichnung | Stok<br>Stock<br>Lager |   | Takım Ölçüleri (mm)<br>Dimension (mm)<br>Abmessung (mm) |      |     |     |     |      |      | Kesici Uç<br>Insert<br>Wendeschneidplatte | Yedek Parçaları / Spare Parts / Ersatzteile |   |
|--|------------------------|---|---|------|-----|-----|-----|------|------|---|---|---|
|  | R                      | L | DCON  | DMIN | LF  | OHN | CDX | H    | WF   |   | Sıkma Vidası<br>Screw<br>Klemmschraube      | Anahtar<br>Allen Key<br>Innensechskantschlüssel |
| AIKT-RD-R/L-16-2-T6                                | ●                      | ○ | 16  | 24   | 150 | 28  | 6   | 14.8 | 14   | RD. - 2                                   | 2503-M4x10                                  | AAL-03-3  |
| AIKT-RD-R/L-20-2-T6                                | ●                      | ○ | 20  | 28   | 170 | 28  | 6   | 18.3 | 16   |   |   |   |
| AIKT-RD-R/L-25-2-T6                                | ●                      | ○ | 25  | 33   | 200 | 28  | 6   | 23   | 18.5 | RD. - 3                                   | 2504-M5x16                                  | AAL-05-4  |
| AIKT-RD-R/L-16-3-T6                                | ●                      | ○ | 16  | 24   | 150 | 28  | 6   | 14.8 | 14   |   |   |   |
| AIKT-RD-R/L-20-3-T6                                | ●                      | ○ | 20  | 28   | 170 | 28  | 6   | 18.3 | 16   |   |   |   |
| AIKT-RD-R/L-25-3-T6                                | ●                      | ○ | 25  | 33   | 200 | 28  | 6   | 23   | 18.5 | RD. - 4                                   | 2504-M5x16                                  | AAL-05-4  |
| AIKT-RD-R/L-32-3-T6                                | ●                      | ○ | 32  | 40   | 250 | 50  | 6   | 30   | 22   |   |   |   |
| AIKT-RD-R/L-20-4-T6                                | ●                      | ○ | 20  | 28   | 170 | 28  | 6   | 18.3 | 16   | RD. - 4                                   | 2004-M8x1x20                                | AAL-05-4  |
| AIKT-RD-R/L-25-4-T6                                | ●                      | ○ | 25  | 33   | 200 | 28  | 6   | 23   | 18.5 |   |   |   |
| AIKT-RD-R/L-32-4-T6                                | ●                      | ○ | 32  | 40   | 250 | 50  | 6   | 30   | 22   | RD. - 4                                   | 2004-M8x1x20                                | AAL-05-4  |

R: Sağ / Right / Rechts L: Sol / Left / Links  
● Stokta / In Stock / Auf Lager ○ Stokta Yok / Non Stock Item / Kein Lagerartikel, Lieferzeit auf Anfrage  
TGTC Ucuna Uygundur. / Compatible with TGTC Insert. / Kompatibel mit TGTC Wendeplatten.

Sipariş Örneği/Ordering Example/Bestellbeispiel  
1 ad./pcs./stück AIKT-154.91-R-16-3-T3

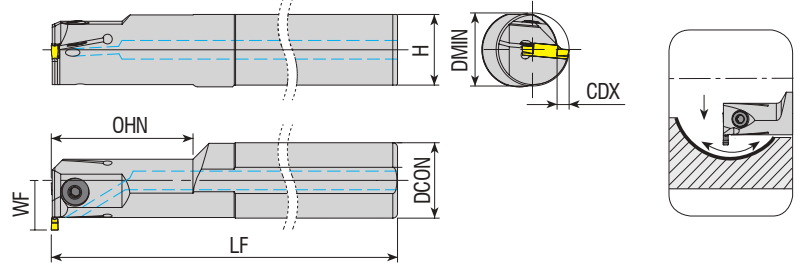

| Takım Kodu<br>Ordering Code<br>Bestell-Bezeichnung | Stok<br>Stock<br>Lager |   | Takım Ölçüleri (mm)<br>Dimension (mm)<br>Abmessung (mm) |      |     |     |     |      |      | Kesici Uç<br>Insert<br>Wendeschneidplatte | Yedek Parçaları / Spare Parts / Ersatzteile |   |
|--|------------------------|---|---|------|-----|-----|-----|------|------|---|---|---|
|  | R                      | L | DCON  | DMIN | LF  | OHN | CDX | H    | WF   |   | Sıkma Vidası<br>Screw<br>Klemmschraube      | Anahtar<br>Allen Key<br>Innensechskantschlüssel |
| AIKT-TD-R/L-16-2-T8.5-H                            | ●                      | ○ | 16  | 25   | 150 | 28  | 8.5 | 14.8 | 16.5 | TD. - 2                                   | 2503-M4x10                                  | AAL-03-3  |
| AIKT-TD-R/L-20-3-T6-H                              | ●                      | ○ | 20  | 25   | 170 | 40  | 6   | 18.3 | 16   |   |   |   |
| AIKT-TD-R/L-25-3-T6-H                              | ●                      | ○ | 25  | 25   | 200 | 40  | 6   | 23   | 18.5 | TD. - 3                                   | 2504-M5x12<br>2504-M5x16                    | AAL-05-4  |
| AIKT-TD-R/L-32-3-T5-H                              | ●                      | ○ | 32  | 31   | 250 | 60  | 5   | 30   | 21   |   |   |   |
| <b>new</b> AIKT-TD-R/L-20-4-T10-H                  | ○                      | ● | 20  | 27   | 170 | 40  | 10  | 18.3 | 20   | TD. - 4                                   | 2504-M5X12<br>2504-M5X16                    | AAL-05-4  |
| <b>new</b> AIKT-TD-R/L-25-4-T10-H                  | ○                      | ● | 25  | 31   | 200 | 40  | 10  | 23   | 22.5 |   |   |   |
| <b>new</b> AIKT-TD-R/L-32-4-T10-H                  | ○                      | ● | 32  | 36   | 250 | 60  | 10  | 30   | 26   |   | 2004-M8X1X20                                |   |

TGTC Ucuna Uygundur. / Compatible with TGTC Insert. / Kompatibel mit TGTC Wendepplatten.

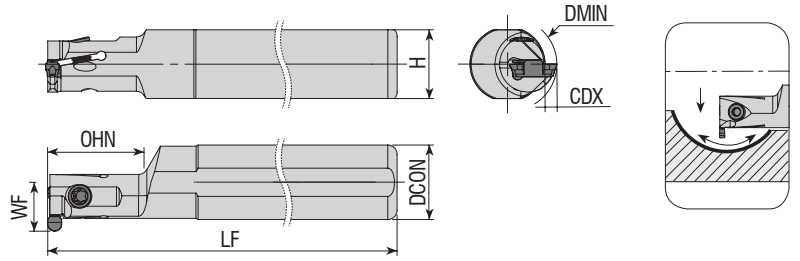

| Takım Kodu<br>Ordering Code<br>Bestell-Bezeichnung | Stok<br>Stock<br>Lager |   | Takım Ölçüleri (mm)<br>Dimension (mm)<br>Abmessung (mm) |      |     |     |     |      |      | Kesici Uç<br>Insert<br>Wendeschneidplatte | Yedek Parçaları / Spare Parts / Ersatzteile |  |
|--|------------------------|---|---|------|-----|-----|-----|------|------|---|---|--|
|  | R                      | L | DCON  | DMIN | LF  | OHN | CDX | H    | WF   |   | Sıkma Vidası<br>Screw<br>Klemmschraube      | Tork Anahtar<br>Torx Key<br>Torx Innensechskantschlüssel |
| AIKT-IGE-R/L-10-2-T3-H                             | ●                      | ○ | 10  | 11.5 | 125 | 25  | 3   | 9    | 8.3  | GEPI - 2                                  | 3008-M3x8                                   | 82-T08   |
| AIKT-IGE-R/L-16-2-T3-D11.5                         | ●                      | ○ | 16  | 11.5 | 125 | 20  | 3   | 14.8 | 11.1 |   |   |  |
| <b>new</b> AIKT-IGE-R/L-16-2-T3-D11.5-H            | ●                      | ○ | 16  | 11   | 125 | 22  | 3   | 14.8 | 11   | GEPI - 3                                  | 1315-M4x11                                  | 80-T15   |
| AIKT-IGE-R/L-16-2-T2.5-H                           | ●                      | ● | 16  | 13   | 125 | 20  | 2.5 | 14.8 | 10.5 |   |   |  |
| AIKT-IGE-R/L-16-3-T2.5-H                           | ●                      | ○ | 16  | 13   | 125 | 20  | 2.5 | 14.8 | 10.5 |   |   |  |
| AIKT-IGE-R/L-16-3-T2.5-D20                         | ●                      | ○ | 16  | 20   | 125 | 28  | 2.5 | 14.8 | 10.5 |   |   |  |

R: Sağ / Right / Rechts L: Sol / Left / Links

● Stokta / In Stock / Auf Lager ○ Stokta Yok / Non Stock Item / Kein Lagerartikel, Lieferzeit auf Anfrage  
ISCR Ucuna Uygundur. / Compatible with ISCR Insert. / Kompatibel mit ISCR Wendepplatten.

Sipariş Örneği/Ordering Example/Bestellbeispiel  
1 ad./pcs./stück AIKT-TD-R-16-2-T8.5-H

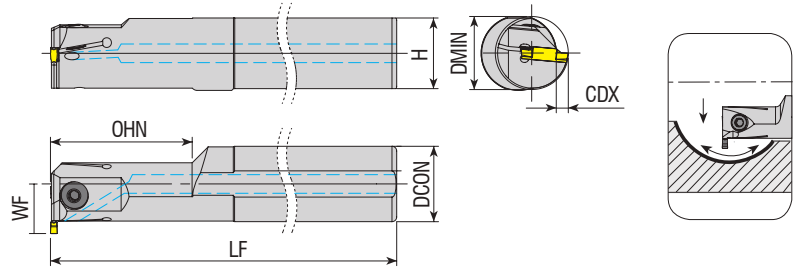

| Takım Kodu<br>Ordering Code<br>Bestell-Bezeichnung | Stok<br>Stock<br>Lager |   | Takım Ölçüleri (mm)<br>Dimension (mm)<br>Abmessung (mm) |      |     |     |     |      |      | Kesici Uç<br>Insert<br>Wendeschneidplatte | Yedek Parçaları / Spare Parts / Ersatzteile |   |   |
|--|------------------------|---|---|------|-----|-----|-----|------|------|---|---|---|---|
|  | R                      | L | DCON  | DMIN | LF  | OHN | CDX | H    | WF   |   | Sıkma Vidası<br>Screw<br>Klemmschraube      | Tork Anahtar<br>Torx Key<br>Innensechskantschlüssel | Anahtar<br>Allen Key<br>Innensechskantschlüssel |
| AIKT-IGI-R/L-20-3-T4                               | ●                      | ● | 20  | 20   | 170 | 25  | 4   | 18.3 | 14.5 | GIMIY / GIPI - 3                          | 1020-M5x14                                  | 80-T20  |   |
| AIKT-IGI-R/L-25-3-T5                               | ●                      | ● | 25  | 23   | 200 | 30  | 5   | 23   | 17   |   | 2504-M5x16                                  | AAL-05-4  |   |
| AIKT-IGI-R/L-32-3-T5                               | ●                      | ● | 32  | 31   | 250 | 30  | 5   | 30   | 21   |   | 2004-M8x1x20                                |   |   |
| AIKT-IGI-R/L-40-3-T5                               | ●                      | ○ | 40  | 50   | 300 | 50  | 5   | 37.5 | 25   | GIMIY / GIPI - 4                          | 1020-M5x14                                  | 80-T20  |   |
| AIKT-IGI-R/L-20-4-T4                               | ●                      | ● | 20  | 20   | 170 | 25  | 4   | 18.3 | 14.5 |   |   |   |   |
| AIKT-IGI-R/L-25-5-T10                              | ●                      | ○ | 25  | 32   | 200 | 25  | 10  | 23   | 22.5 | GIMIY / GIPI - 5                          | 2504-M5x16                                  | AAL-05-4  |   |
| AIKT-IGI-R/L-25-5-T10-H                            | ●                      | ○ | 25  | 32   | 200 | 25  | 10  | 23   | 22.5 |   |   |   |   |
| AIKT-IGI-R/L-25-5-T15                              | ●                      | ○ | 25  | 37   | 200 | 25  | 15  | 23   | 27.5 |   |   |   |   |
| AIKT-IGI-R/L-25-5-T15-H                            | ●                      | ○ | 25  | 37   | 200 | 25  | 15  | 23   | 27.5 |   |   |   |   |

ISCR Ucuna Uygundur. / Compatible with ISCR Insert. / Kompatibel mit ISCR Wendeplatten.

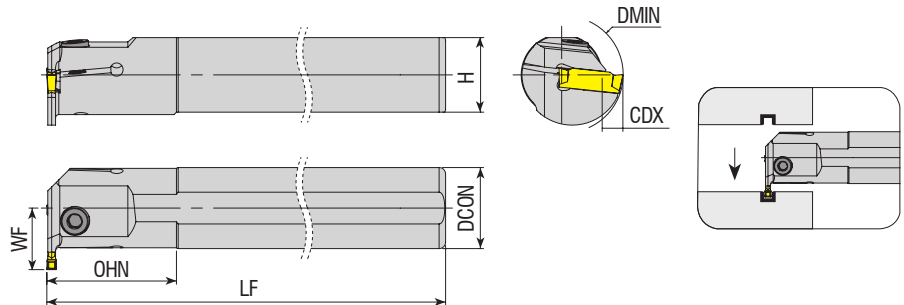

| Takım Kodu<br>Ordering Code<br>Bestell-Bezeichnung | Stok<br>Stock<br>Lager |   | Takım Ölçüleri (mm)<br>Dimension (mm)<br>Abmessung (mm) |      |     |     |     |      |      | Kesici Uç<br>Insert<br>Wendeschneidplatte | Yedek Parçaları / Spare Parts / Ersatzteile |   |  |
|--|------------------------|---|---|------|-----|-----|-----|------|------|---|---|---|--|
|  | R                      | L | DCON  | DMIN | LF  | OHN | CDX | H    | WF   |   | Sıkma Vidası<br>Screw<br>Klemmschraube      | Anahtar<br>Allen Key<br>Innensechskantschlüssel |  |
| AIKT-I-R/L-20-3-T5                                 | ●                      | ● | 20  | 26   | 170 | 25  | 5   | 18.3 | 15.5 | DGN - 3                                   | 2504-M5x12                                  | AAL-05-4  |  |
| AIKT-I-R/L-25-3-T6                                 | ●                      | ● | 25  | 32   | 200 | 40  | 6   | 23   | 19   |   | 2504-M5x16                                  |   |  |

R: Sağ / Right / Rechts L: Sol / Left / Links

● Stokta / In Stock / Auf Lager ○ Stokta Yok / Non Stock Item / Kein Lagerartikel, Lieferzeit auf Anfrage

ISCR Ucuna Uygundur. / Compatible with ISCR Insert. / Kompatibel mit ISCR Wendeplatten.

Sipariş Örneği/Ordering Example/Bestellbeispiel

1 ad./pcs./stück AIKT-IGI-R-20-3-T4

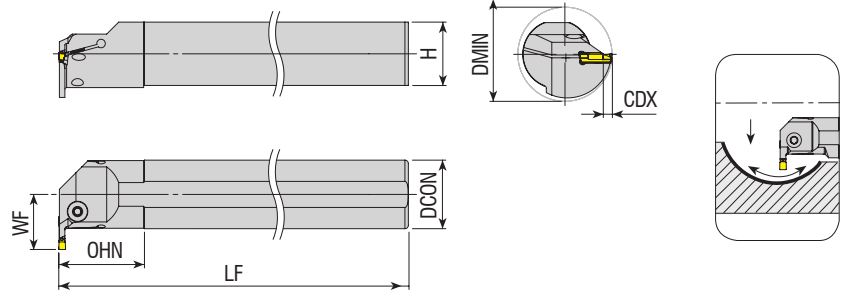

| Takım Kodu<br>Ordering Code<br>Bestell-Bezeichnung | Stok<br>Stock<br>Lager |   | Takım Ölçüleri (mm)<br>Dimension (mm)<br>Abmessung (mm) |      |     |     |     |      |      | Kesici Uç<br>Insert<br>Wendeschneidplatte | Yedek Parçaları / Spare Parts / Ersatzteile |   |
|--|------------------------|---|---|------|-----|-----|-----|------|------|---|---|---|
|  | R                      | L | DCON  | DMIN | LF  | OHN | CDX | H    | WF   |   | Sıkma Vidası<br>Screw<br>Klemmschraube      | Anahtar<br>Allen Key<br>Innensechskantschlüssel |
| AIKT-IG-R/L-25-4-T10-H                             | ●                      | ● | 25  | 36   | 200 | 40  | 10  | 23   | 22.7 | DGN / GRP - 4                             | 2504-M5X16                                  | AAL-05-4  |
| AIKT-IG-R/L-32-4-T10-H                             | ●                      | ● | 32  | 43   | 250 | 45  | 10  | 30   | 26.2 |   | 2004-M8x1x20                                |   |
| AIKT-IG-R/L-40-4-T12-H                             | ●                      | ● | 40  | 53   | 250 | 50  | 12  | 37.5 | 32.2 |   | 2504-M5X16                                  |   |
| AIKT-IG-R/L-25-5-T10-H                             | ●                      | ○ | 25  | 43   | 200 | 40  | 10  | 23   | 22.7 | DGN / GRP - 5                             | 2004-M8x1x20                                |   |
| AIKT-IG-R/L-32-5-T10-H                             | ●                      | ○ | 32  | 43   | 250 | 45  | 10  | 30   | 26.2 |   | 2504-M5X16                                  |   |
| AIKT-IG-R/L-40-5-T12-H                             | ●                      | ○ | 40  | 53   | 250 | 50  | 12  | 37.5 | 32.2 |   | 2004-M8x1x20                                |   |
| AIKT-IG-R/L-50-5-T12-H                             | ●                      | ○ | 50  | 63   | 300 | 60  | 12  | 47   | 37.2 |   | 2004-M8x1x20                                |   |

ISCR Ucuna Uygundur. / Compatit le wth ISCR Insert. / Kompatibel mit ISCR Wendepplatten.

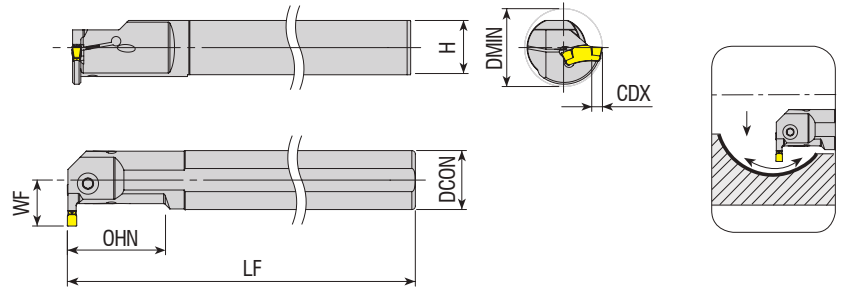

| Takım Kodu<br>Ordering Code<br>Bestell-Bezeichnung | Stok<br>Stock<br>Lager |   | Takım Ölçüleri (mm)<br>Dimension (mm)<br>Abmessung (mm) |      |     |     |      |      |      | Kesici Uç<br>Insert<br>Wendeschneidplatte | Yedek Parçaları / Spare Parts / Ersatzteile |  |          |
|--|------------------------|---|---|------|-----|-----|------|------|------|---|---|--|----------|
|  | R                      | L | DCON  | DMIN | LF  | OHN | CDX  | H    | WF   |   | Sıkma Vidası<br>Screw<br>Klemmschraube      | Tork Anahtar<br>Torx Key<br>Torn Innensechskantschlüssel |          |
| AIKT-ITG-R/L-16-3-T6-H                             | ●                      | ● | 16  | 20   | 150 | 25  | 6    | 14.8 | 12   | TGM. - 3                                  | 1020-M4.5X14                                | 80-T20   |          |
| AIKT-ITG-R/L-20-3-T6-H                             | ●                      | ● | 20  | 25   | 170 | 32  | 6    | 18.3 | 14.2 |   | 1020-M4.5X16                                |  |          |
| AIKT-ITG-R/L-25-3-T8-H                             | ●                      | ● | 25  | 32   | 200 | 40  | 8    | 23   | 18.8 |   | 2504-M5X16                                  |  |          |
| AIKT-ITG-R/L-32-3-T8-H                             | ●                      | ● | 32  | 38   | 250 | 49  | 8    | 30   | 22   | 2004-M8x1x20                              | AAL-05-4                                    |  |          |
| AIKT-ITG-R/L-20-4-T6-H                             | ●                      | ● | 20  | 25   | 170 | 33  | 6    | 18.3 | 14.2 | TGM. - 4                                  | 1020-M4.5X16                                |  | 80-T20   |
| AIKT-ITG-R/L-25-4-T7-H                             | ●                      | ● | 25  | 31   | 200 | 41  | 7    | 23   | 17.5 |   | 2504-M5X16                                  |  | AAL-05-4 |
| AIKT-ITG-R/L-25-4-T9-H                             | ●                      | ● | 25  | 32.5 | 200 | 41  | 9    | 23   | 19.5 |   | 2504-M5X16                                  |  |          |
| AIKT-ITG-R/L-32-4-T11-H                            | ●                      | ● | 32  | 42   | 250 | 50  | 11   | 30   | 25.5 |   | 2504-M5X16                                  |  |          |
| AIKT-ITG-R/L-40-4-T11-H                            | ●                      | ● | 40  | 53   | 300 | 50  | 11   | 37.5 | 32   | 2004-M8x1x20                              |   |  |          |
| AIKT-ITG-R/L-32-6.35-T17.5-H                       | ●                      | ● | 32  | 57   | 250 | 50  | 17.5 | 30   | 29   | TGM. - 6.35                               | 2004-M8x1x20                                |  |          |

R: Sağ / Right / Rechts L: Sol / Left / Links

● Stokta / In Stock / Auf Lager ○ Stokta Yok / Non Stock Item / Kein Lagerartikel, Lieferzeit auf Anfrage  
ISCR Ucuna Uygundur. / Compatible with ISCR Insert. / Kompatibel mit ISCR Wendepplatten.

Sipariş Örneği/Ordering Example/Bestellbeispiel  
1 ad./pcs./stück AIKT-IG-R-25-4-T10-H

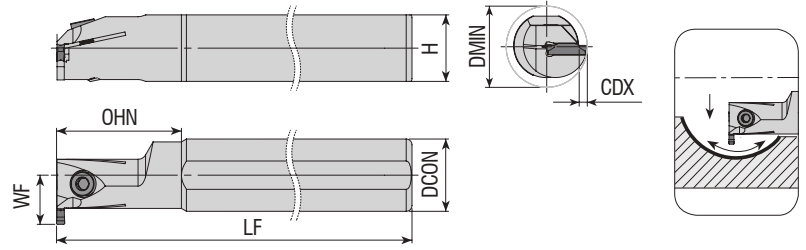

| Takım Kodu<br>Ordering Code<br>Bestell-Bezeichnung | Stok<br>Stock<br>Lager |   | Takım Ölçüleri (mm)<br>Dimension (mm)<br>Abmessung (mm) |      |     |     |     |      |      | Kesici Uç<br>Insert<br>Wendescheidplatte | Yedek Parçaları / Spare Parts / Ersatzteile |   |
|--|------------------------|---|---|------|-----|-----|-----|------|------|--|---|---|
|  | R                      | L | DCON  | DMIN | LF  | OHN | CDX | H    | WF   |  | Sıkma Vidası<br>Screw<br>Klemmschraube      | Anahtar<br>Allen Key<br>Innensechskantschlüssel |
| AIKT-GP-R/L-20-2-T4                                | ●                      | ○ | 20  | 25   | 170 | 30  | 4   | 18.3 | 14.5 | GP - 2                                   | 2503-M4x12                                  | AAL-03-3  |
| AIKT-GP-R/L-25-2-T6                                | ●                      | ○ | 25  | 32   | 200 | 40  | 6   | 23   | 18.5 |  |   |   |
| AIKT-GP-R/L-20-3-T6                                | ●                      | ○ | 20  | 27   | 170 | 30  | 6   | 18.3 | 16   | GP - 3                                   | 2504-M5x16                                  | AAL-05-4  |
| AIKT-GP-R/L-25-3-T6                                | ●                      | ○ | 25  | 32   | 200 | 40  | 6   | 23   | 18.5 |  |   |   |
| AIKT-GP-R/L-32-3-T6                                | ●                      | ○ | 32  | 39   | 250 | 50  | 6   | 30   | 22   |  |   |   |
| AIKT-GP-R/L-20-4-T6                                | ●                      | ○ | 20  | 27   | 170 | 30  | 6   | 18.3 | 16   | GP - 4                                   | 2504-M5x16                                  |   |
| AIKT-GP-R/L-25-4-T6                                | ●                      | ○ | 25  | 32   | 200 | 40  | 6   | 23   | 18.5 |  |   |   |
| AIKT-GP-R/L-32-4-T6                                | ●                      | ○ | 32  | 39   | 250 | 50  | 6   | 30   | 22   |  | 2004-M8x1x20                                |   |

PLBT Ucuna Uygunur. / Compatible with PLBT Insert. / Kompatibel mit PLBT Wendeplatten.

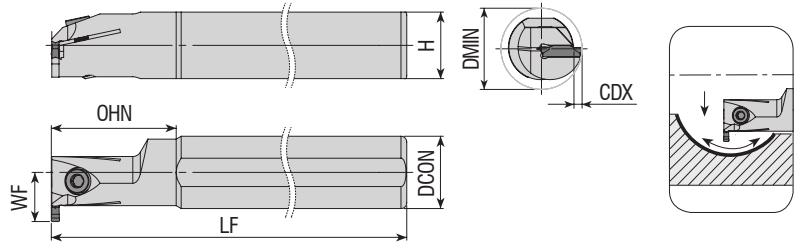

| Takım Kodu<br>Ordering Code<br>Bestell-Bezeichnung | Stok<br>Stock<br>Lager |   | Takım Ölçüleri (mm)<br>Dimension (mm)<br>Abmessung (mm) |      |     |     |     |      |      | Kesici Uç<br>Insert<br>Wendescheidplatte | Yedek Parçaları / Spare Parts / Ersatzteile |  |
|--|------------------------|---|---|------|-----|-----|-----|------|------|--|---|--|
|  | R                      | L | DCON  | DMIN | LF  | OHN | CDX | H    | WF   |  | Sıkma Vidası<br>Screw<br>Klemmschraube      | Tork Anahtar<br>Torx Key<br>Torx Innensechskantschlüssel |
| AIKT-TG-R/L-20-2-T6                                | ●                      | ○ | 20  | 28   | 160 | 28  | 6   | 18.3 | 15.8 | DGM2-020                                 | 2503-M4x10                                  | AAL-03-3   |
| AIKT-TG-R/L-20-3-T6                                | ●                      | ○ | 20  | 28   | 160 | 28  | 6   | 18.3 | 15.8 |  |   |  |
| AIKT-TG-R/L-25-3-T8                                | ●                      | ○ | 25  | 35   | 200 | 28  | 8   | 23   | 21.5 | DTX3-030                                 | 2504-M5x16                                  | AAL-05-4   |
| AIKT-TG-R/L-32-3-T10                               | ●                      | ○ | 32  | 43   | 250 | 50  | 10  | 30   | 27   |  |   |  |
| AIKT-TG-R/L-32-3-T12                               | ●                      | ○ | 32  | 45   | 250 | 50  | 12  | 30   | 27   |  |   |  |
| AIKT-TG-R/L-32-4-T10                               | ●                      | ○ | 32  | 43   | 250 | 50  | 10  | 30   | 27   | DTX4-040                                 | 2004-M8x1x20                                |  |
| AIKT-TG-R/L-32-5-T10                               | ●                      | ○ | 32  | 43   | 250 | 50  | 10  | 30   | 27   |  |   | DTX5-040   |

R: Sağ / Right / Rechts L: Sol / Left / Links  
● Stokta / In Stock / Auf Lager ○ Stokta Yok / Non Stock Item / Kein Lagerartikel, Lieferzeit auf Anfrage  
TNGLY Ucuna Uygunur. / Compatible with TNGLY Insert. / Kompatibel mit TNGLY Wendeplatten.

Sipariş Örneği/Ordering Example/Bestellbeispiel  
1 ad./pcs./stück AIKT-GP-R-20-2-T4

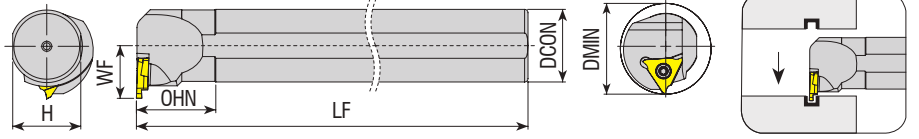

| Takım Kodu<br>Ordering Code<br>Bestell-Bezeichnung | Stok<br>Stock<br>Lager |   | Takım Ölçüleri (mm)<br>Dimension (mm)<br>Abmessung (mm) |      |     |     |     |      |      | Kesici Uç<br>Insert<br>Wendeschneidplatte | Yedek Parçaları / Spare Parts / Ersatzteile |  |
|--|------------------------|---|---|------|-----|-----|-----|------|------|---|---|--|
|  | R                      | L | DCON  | DMIN | LF  | OHN | CDX | H    | WF   |   | Sıkma Vidası<br>Screw<br>Klemmschraube      | Tork Anahtar<br>Torx Key<br>Torx Innensechskantschlüssel |
| AIKT-QC11-R/L-20-(0.5-1.8)                         | ●                      | ○ | 20  | 16   | 150 | 40  | -   | 18.3 | 11.1 |   | 3008 M2.5x6                                 | 82-T08   |
| AIKT-QC16-R/L-20-(0.5-1.8)                         | ○                      | ○ | 20  | 25   | 150 | 35  | -   | 18.3 | 13.5 |   | 4015-M3.5x10                                | 80-T15   |
| AIKT-QC16-R/L-20-(0.5-2.5)                         | ●                      | ○ | 20  | 25   | 150 | 35  | -   | 18.3 | 13.5 |   |   |  |
| AIKT-QC22-R/L-25-(1-2.3)                           | ○                      | ○ | 25  | 35   | 150 | 35  | -   | 23   | 18.2 |   |   |  |
| AIKT-QC22-R/L-25-(2.5-3.3)                         | ●                      | ○ | 25  | 35   | 150 | 35  | -   | 23   | 18.2 |   | 1020 M5x11                                  | 80-T20   |
| AIKT-QC22-R/L-25-(3.3-4.8)                         | ●                      | ○ | 25  | 35   | 150 | 35  | -   | 23   | 18.2 |   |   |  |
| AIKT-QC22-R/L-32-(1-2.3)                           | ○                      | ○ | 32  | 45   | 150 | 35  | -   | 30   | 23.2 |   |   |  |

ZCC Ucuna Uygundur. / Compatible with ZCC Insert. / Kompatibel mit ZCC Wendeplatten.

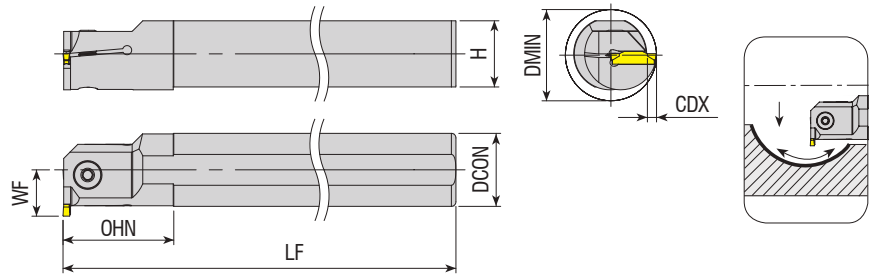

| Takım Kodu<br>Ordering Code<br>Bestell-Bezeichnung | Stok<br>Stock<br>Lager |   | Takım Ölçüleri (mm)<br>Dimension (mm)<br>Abmessung (mm) |      |     |     |     |      |      | Kesici Uç<br>Insert<br>Wendeschneidplatte | Yedek Parçaları / Spare Parts / Ersatzteile |   |
|--|------------------------|---|---|------|-----|-----|-----|------|------|---|---|---|
|  | R                      | L | DCON  | DMIN | LF  | OHN | CDX | H    | WF   |   | Sıkma Vidası<br>Screw<br>Klemmschraube      | Anahtar<br>Allen Key<br>Innensechskantschlüssel |
| AIKT-ZCC2-R/L-16-2-T4                              | ●                      | ○ | 16  | 21   | 150 | 28  | 4   | 14.8 | 12   |   | 2503-M4x10                                  | AAL-03-3  |
| AIKT-ZCC2-R/L-20-3-T5                              | ●                      | ● | 20  | 27   | 170 | 30  | 5   | 18.3 | 15   |   | 2504-M5x12                                  |   |
| AIKT-ZCC2-R/L-20-3-T8                              | ●                      | ○ | 20  | 29   | 170 | 30  | 8   | 18.3 | 18   |   | 2504-M5x16                                  |   |
| AIKT-ZCC2-R/L-25-3-T5                              | ●                      | ○ | 25  | 31   | 200 | 40  | 5   | 23   | 17.5 |   |   |   |
| AIKT-ZCC2-R/L-25-3-T10                             | ●                      | ○ | 25  | 36   | 200 | 40  | 10  | 23   | 22.5 |   | 2004-M8x1x20                                |   |
| AIKT-ZCC2-R/L-32-3-T6                              | ●                      | ○ | 32  | 39   | 250 | 50  | 6   | 30   | 22   |   |   |   |
| AIKT-ZCC2-R/L-32-3-T8                              | ●                      | ○ | 32  | 41   | 250 | 50  | 8   | 30   | 24   |   |   |   |
| AIKT-ZCC2-R/L-32-3-T13                             | ●                      | ○ | 32  | 46   | 250 | 50  | 13  | 30   | 29   |   | 2504-M5x12                                  | AAL-05-4  |
| AIKT-ZCC2-R/L-40-3-T12                             | ●                      | ○ | 40  | 53   | 300 | 55  | 12  | 37.5 | 32   |   |   |   |
| AIKT-ZCC2-R/L-25-4-T6                              | ●                      | ○ | 25  | 32   | 200 | 40  | 6   | 23   | 18.5 |   | 2504-M5x16                                  |   |
| AIKT-ZCC2-R/L-32-4-T7                              | ●                      | ○ | 32  | 40   | 250 | 50  | 7   | 30   | 23   |   |   |   |
| AIKT-ZCC2-R/L-32-4-T8                              | ●                      | ○ | 32  | 41   | 250 | 50  | 8   | 30   | 24   |   |   |   |
| AIKT-ZCC2-R/L-32-4-T10                             | ●                      | ○ | 32  | 43   | 250 | 50  | 10  | 30   | 26   |   |   |   |
| AIKT-ZCC2-R/L-32-5-T7                              | ●                      | ○ | 32  | 40   | 250 | 50  | 7   | 30   | 23   |   | 2004-M8x1x20                                |   |
| AIKT-ZCC2-R/L-32-5-T8                              | ●                      | ○ | 32  | 41   | 250 | 50  | 8   | 30   | 24   |   |   |   |
| AIKT-ZCC2-R/L-40-5-T8                              | ●                      | ○ | 40  | 49   | 300 | 55  | 8   | 37.5 | 28   |   |   |   |
| AIKT-ZCC2-R/L-40-5-T10                             | ●                      | ○ | 40  | 51   | 300 | 55  | 10  | 37.5 | 30   |   |   |   |

R: Sağ / Right / Rechts L: Sol / Left / Links

● Stokta / In Stock / Auf Lager ○ Stokta Yok / Non Stock Item / Kein Lagerartikel, Lieferzeit auf Anfrage

ZCC Ucuna Uygundur. / Compatible with ZCC Insert. / Kompatibel mit ZCC Wendeplatten.

Sipariş Örneği/Ordering Example/Bestellbeispiel

1 ad./pcs./stück AIKT-QC11-R-20-(0.5-1.8)

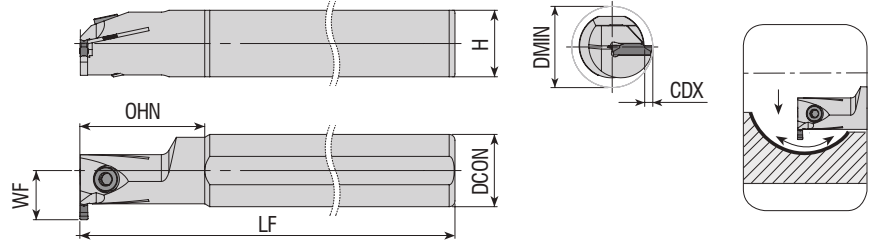

**Takım Kodu**  
**Ordering Code**  
*Bestell-Bezeichnung*

| Takım Kodu<br>Ordering Code<br>Bestell-Bezeichnung | Stok<br>Stock<br>Lager |   | Takım Ölçüleri (mm)<br>Dimension (mm)<br>Abmessung (mm) |      |     |     |     |      |      | Kesici Uç<br>Insert<br>Wendeschneidplatte | Yedek Parçaları / Spare Parts / Ersatzteile |   |
|--|------------------------|---|---|------|-----|-----|-----|------|------|---|---|---|
|  | R                      | L | DCON  | DMIN | LF  | OHN | CDX | H    | WF   |   | Sıkma Vidası<br>Screw<br>Klemmschraube      | Anahtar<br>Allen Key<br>Innensechskantschlüssel |
| AIKT-SGC-R/L-25-3-T6                               | ●                      | ○ | 25  | 32   | 200 | 40  | 6   | 23   | 18.5 | GCM N30                                   | 2504-M5x16                                  | AAL-05-4  |
| AIKT-SGC-R/L-32-3-T6                               | ●                      | ○ | 32  | 39   | 250 | 50  | 6   | 30   | 22   |   | 2004-M8x1x20                                |   |
| AIKT-SGC-R/L-40-3-T6                               | ●                      | ○ | 40  | 47   | 300 | 55  | 6   | 37.5 | 26   |   |   |   |

SMTM Ucuna Uygunur. / Compatible with SMTM Insert. / Kompatibel mit SMTM Wendeplatten.

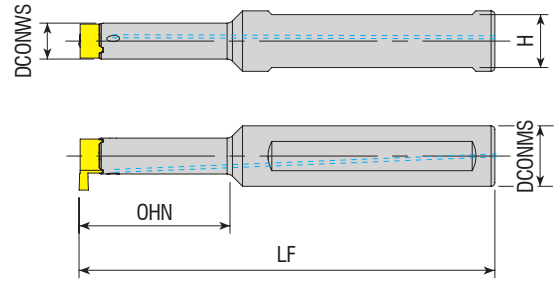

**Takım Kodu**  
**Ordering Code**  
*Bestell-Bezeichnung*

| Takım Kodu<br>Ordering Code<br>Bestell-Bezeichnung | Stok<br>Stock<br>Lager | Takım Ölçüleri (mm)<br>Dimension (mm)<br>Abmessung (mm) |        |     |     |    | Kesici Uç<br>Insert<br>Wendeschneidplatte | Yedek Parçaları / Spare Parts / Ersatzteile |  |
|--|------------------------|---|--------|-----|-----|----|---|---|--|
|  |                        | DCONMS  | DCONWS | LF  | OHN | H  |   | Sıkma Vidası<br>Screw<br>Klemmschraube      | Tork Anahtar<br>Torx Key<br>Torx Innensechskantschlüssel |
| AIKT-MB07-A16-090-15                               | ●                      | 16  | 7.4    | 90  | 15  | 14 | MB - 07                                   | 4008-M3x8                                   | 82-T08   |
| AIKT-MB07-A16-090-22                               | ●                      | 16  | 7.4    | 90  | 22  | 14 |   |   |  |
| AIKT-MB09-A16-090-19                               | ●                      | 16  | 9.5    | 90  | 19  | 14 | MB - 09                                   | 4015-M4x11                                  | 80-T15   |
| AIKT-MB09-A16-095-28                               | ●                      | 16  | 9.5    | 95  | 28  | 14 |   |   |  |
| AIKT-MB09-A16-110-40                               | ●                      | 16  | 9.5    | 110 | 40  | 14 |   |   |  |

R: Sağ / Right / Rechts L: Sol / Left / Links

● Stokta / In Stock / Auf Lager ○ Stokta Yok / Non Stock Item / Kein Lagerartikel, Lieferzeit auf Anfrage

SNDVK Ucuna Uygunur. / Compatible with SNDVK Insert. / Kompatibel mit SNDVK Wendeplatten.

Sipariş Örneği/Ordering Example/Bestellbeispiel

1 ad./pcs./stück AIKT-SGC-R-25-3-T6

**konusulan**  
the spoken **kalite...**  
quality...







**DELİK DELME ve İŞLEME TAKIMLARI**  
*DRILLING and HOLEMAKING TOOLS*  
*BOHRWERKZEUGE*





*konusulan  
the spoken kalite...  
quality...*

# U-DRILL

TAKMA UÇLU MATKAPLAR  
U-DRILL SYSTEM  
VOLLBOHRER





**AKKO** **A** **TUM** **16** x **D3**  
**S** **P** **G** **T** **06** **02** **04**

**2** Kesici Stili / Cutter Style  
Werkzeugtyp

TUM: Takma Uçlu Matkap  
U-Drill  
Vollbohrer

**3** Takım Çapı / Tool Diameter /  
Werkzeugdurchmesser

**4** Delme Derinliği / Drilling Depth /  
Bohrtiefe

**5** Uç Şekli / Insert Form  
Plattenform

**W** **S**

**6** Serbest Uç Açısı / Clearance angle of Insert  
Freiwinkel der Wendschneidplatte

**C** **P**

**8** Uç Tipi / Insert Type  
Plattentyp

A J T   
 $\beta = 70-90^\circ$   $\beta = 70-90^\circ$   $\beta = 40-60^\circ$

B M U   
 $\beta = 70-90^\circ$   $\beta = 40-60^\circ$   $\beta = 40-60^\circ$

C N W   
 $\beta = 70-90^\circ$   $\beta = 40-60^\circ$   $\beta = 40-60^\circ$

F Q X **Özel**  
 $\beta = 70-90^\circ$   $\beta = 40-60^\circ$  **Special**

H R **Sonder**

**10** Kalınlık / Thickness  
Dicke

01 s = 1.59  
T1 s = 1.98  
02 s = 2.38  
T2 s = 2.78  
03 s = 3.18  
T3 s = 3.97  
04 s = 4.76  
05 s = 5.56  
06 s = 6.35  
07 s = 7.94  
09 s = 9.52

**7** Toleranslar / Tolerance Classes / Toleranzen

|   | IC          | M           | S       |
|---|-------------|-------------|---------|
| A | ± 0.025     | ± 0.005     | ± 0.025 |
| C | ± 0.025     | ± 0.013     | ± 0.025 |
| E | ± 0.025     | ± 0.025     | ± 0.025 |
| F | ± 0.013     | ± 0.005     | ± 0.025 |
| G | ± 0.025     | ± 0.025     | ± 0.130 |
| H | ± 0.013     | ± 0.013     | ± 0.025 |
| J | ± 0.05-0.15 | ± 0.005     | ± 0.025 |
| K | ± 0.05-0.15 | ± 0.013     | ± 0.025 |
| L | ± 0.05-0.15 | ± 0.025     | ± 0.025 |
| M | ± 0.05-0.15 | ± 0.08-0.20 | ± 0.130 |
| N | ± 0.05-0.15 | ± 0.08-0.20 | ± 0.025 |
| U | ± 0.08-0.25 | ± 0.13-0.38 | ± 0.130 |

IC : Daire Ölçüsü / Incribed Circle / Kreisgröße  
M : Şekle Göre / Refer to Figure / Siehe Abbildung  
S : Kalınlık / Thickness / Dicke

**9** Kesme Kenar Uzunluğu / Cutting Edge Length  
Schneidkantenlänge

**11** Köşe Konfigurasyonu / Corner Radius  
Eckenradius

01 r = 0.1  
02 r = 0.2  
04 r = 0.4  
08 r = 0.8  
12 r = 1.2  
16 r = 1.6  
24 r = 2.4



Delme Derinliği  
Drilling Depth  
Bohrtiefe

= 2x Çap  
= 2x Diameter  
= 2x Durchmesser

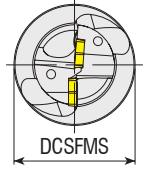
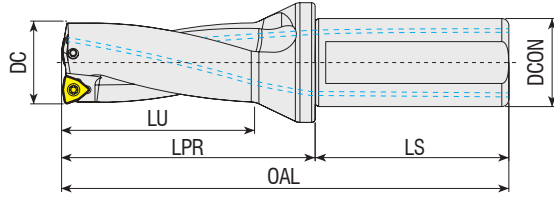

| Takım Kodu<br>Ordering Code<br>Bestell-Bezeichnung | Stok<br>Stock<br>Lager | Takım Ölçüleri (mm)<br>Dimension (mm)<br>Abmessung (mm) |      |        |     |    |     |    | Maks. Ofset (radyal)<br>Max. Offset (radial)<br>Max. Versatz (radial) |                   | Kesici Uç<br>Insert<br>Wendeschneidplatte | Yedek Parçaları / Spare Parts / Ersatzteile |  |
|--|------------------------|---|------|--------|-----|----|-----|----|---|-------------------|---|---|--|
|  |                        | DC  | DCON | DCSFMS | OAL | LU | LPR | LS | X <sub>max</sub>  | DC <sub>max</sub> |   | Sıkma Vidası<br>Screw<br>Schraube           | Tork Anahtar<br>Torx Key<br>Torx-Schlüssel |
| ATUM 16XD2 WCM. 030208                             | ●                      | 16  | 25   | 34     | 110 | 32 | 54  | 56 | 1.5   | 19                | WCM. 030208                               | 3008-M2.5x6                                 | 82-T08                                     |
| ATUM 16.5XD2 WCM. 030208                           | ●                      | 16.5  | 25   | 34     | 110 | 32 | 54  | 56 | 1.5   | 19.5              |   |   |  |
| ATUM 17XD2 WCM. 030208                             | ●                      | 17  | 25   | 34     | 112 | 34 | 56  | 56 | 1.5   | 20                |   |   |  |
| ATUM 17.5XD2 WCM. 030208                           | ●                      | 17.5  | 25   | 34     | 112 | 34 | 56  | 56 | 1.5   | 20.5              |   |   |  |
| ATUM 18XD2 WCM. 030208                             | ●                      | 18  | 25   | 34     | 114 | 36 | 58  | 56 | 1.4   | 20.8              |   |   |  |
| ATUM 18.5XD2 WCM. 030208                           | ●                      | 18.5  | 25   | 34     | 114 | 36 | 58  | 56 | 1.3   | 21.1              |   |   |  |
| ATUM 19XD2 WCM. 030208                             | ●                      | 19  | 25   | 34     | 116 | 38 | 60  | 56 | 1.2   | 21.4              |   |   |  |
| ATUM 19.5XD2 WCM. 030208                           | ●                      | 19.5  | 25   | 34     | 116 | 38 | 60  | 56 | 1.2   | 21.9              |   |   |  |
| ATUM 20XD2 WCM. 040208                             | ●                      | 20  | 25   | 34     | 118 | 40 | 62  | 56 | 1.5   | 23                |   |   |  |
| ATUM 20.5XD2 WCM. 040208                           | ●                      | 20.5  | 25   | 34     | 118 | 40 | 62  | 56 | 1.5   | 23.5              |   |   |  |
| ATUM 21XD2 WCM. 040208                             | ●                      | 21  | 25   | 34     | 120 | 42 | 64  | 56 | 1   | 23                |   |   |  |
| ATUM 21.5XD2 WCM. 040208                           | ●                      | 21.5  | 25   | 34     | 120 | 42 | 64  | 56 | 1   | 23.5              |   |   |  |
| ATUM 22XD2 WCM. 040208                             | ●                      | 22  | 25   | 34     | 122 | 44 | 66  | 56 | 1   | 24                |   |   |  |
| ATUM 22.5XD2 WCM. 040208                           | ●                      | 22.5  | 25   | 34     | 122 | 44 | 66  | 56 | 1   | 24.5              |   |   |  |
| ATUM 23XD2 WCM. 040208                             | ●                      | 23  | 25   | 34     | 124 | 46 | 68  | 56 | 1   | 25                |   |   |  |
| ATUM 23.5XD2 WCM. 040208                           | ●                      | 23.5  | 25   | 34     | 124 | 46 | 68  | 56 | 1   | 25.5              | WCM. 050308                               | 3008-M3x8                                   | 82-T08                                     |
| ATUM 24XD2 WCM. 050308                             | ●                      | 24  | 25   | 34     | 126 | 48 | 70  | 56 | 1.4   | 26.8              |   |   |  |
| ATUM 24.5XD2 WCM. 050308                           | ●                      | 24.5  | 25   | 34     | 126 | 48 | 70  | 56 | 1.4   | 27.3              |   |   |  |
| ATUM 25XD2 WCM. 050308                             | ●                      | 25  | 25   | 34     | 128 | 50 | 72  | 56 | 1.45  | 27.9              |   |   |  |
| ATUM 25.5XD2 WCM. 050308                           | ●                      | 25.5  | 25   | 34     | 128 | 50 | 72  | 56 | 1.45  | 28.4              |   |   |  |
| ATUM 26XD2 WCM. 050308                             | ●                      | 26  | 25   | 34     | 130 | 52 | 74  | 56 | 1.45  | 28.9              |   |   |  |
| ATUM 26.5XD2 WCM. 050308                           | ●                      | 26.5  | 25   | 34     | 130 | 52 | 74  | 56 | 1.45  | 29.4              |   |   |  |
| ATUM 27XD2 WCM. 050308                             | ●                      | 27  | 25   | 34     | 132 | 54 | 76  | 56 | 1.45  | 29.9              |   |   |  |
| ATUM 27.5XD2 WCM. 050308                           | ●                      | 27.5  | 25   | 34     | 132 | 54 | 76  | 56 | 1.45  | 30.4              |   |   |  |
| ATUM 28XD2 WCM. 050308                             | ●                      | 28  | 25   | 34     | 134 | 56 | 78  | 56 | 1.6   | 31.2              |   |   |  |
| ATUM 28.5XD2 WCM. 050308                           | ●                      | 28.5  | 25   | 34     | 134 | 56 | 78  | 56 | 1.6   | 31.7              |   |   |  |
| ATUM 29XD2 WCM. 050308                             | ●                      | 29  | 25   | 34     | 136 | 58 | 80  | 56 | 1.65  | 32.3              |   |   |  |
| ATUM 29.5XD2 WCM. 050308                           | ●                      | 29.5  | 25   | 34     | 136 | 58 | 80  | 56 | 1.65  | 32.8              |   |   |  |

R: Sağ / Right / Rechts/ L: Sol / Left / Links

● Stokta / In Stock / Auf Lager ○ Stokta Yok / Non Stock Item / Kein Lagerartikel, Lieferzeit auf Anfrage  
ISO Ucuna Uygun / Compatible with ISO Insert. / Kompatibel mit ISO Wendeplatten.

Sipariş Örneği/Ordering Example/Bestellbeispiel

1 ad./pcs./stück ATUM 16XD2 WCM. 030208

Takma Uçlu Matkap Kullanım Kılavuzu : S 375 / User's Guide For U-Drills : P 375

Bedienungsanleitung für Vollbohrer : S 375



Delme Derinliği  
Drilling Depth  
Bohrtiefe

= 2x Çap  
= 2x Diameter  
= 2x Durchmesser

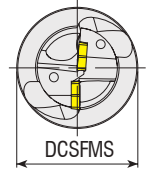
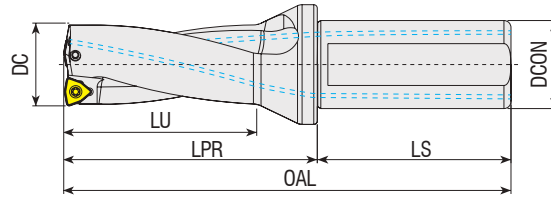

**Takım Kodu**  
**Ordering Code**  
**Bestell-Bezeichnung**

Stok  
Stock  
Lager

Takım Ölçüleri (mm)  
Dimension (mm)  
Abmessung (mm)

Maks. Ofset (radial)  
Max. Offset (radial)  
Max. Versatz (radial)

Kesici Uç  
Insert  
Wendeschneidplatte

Yedek Parçaları / Spare Parts / Ersatzteile

Sıkma Vidası  
Screw  
Schraube

Tork Anahtar  
Torx Key  
Torx-Schlüssel

DC

DCON

DCSFMS

OAL

LU

LPR

LS

X<sub>max</sub> [mm]

DC<sub>max</sub> [mm]

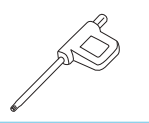
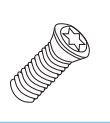

| Takım Kodu<br>Ordering Code<br>Bestell-Bezeichnung | Stok<br>Stock<br>Lager | DC | DCON | DCSFMS | OAL | LU  | LPR | LS | X <sub>max</sub> [mm] | DC <sub>max</sub> [mm] | Kesici Uç<br>Insert<br>Wendeschneidplatte | Sıkma Vidası<br>Screw<br>Schraube | Tork Anahtar<br>Torx Key<br>Torx-Schlüssel |
|--|------------------------|----|------|--------|-----|-----|-----|----|-----------------------|------------------------|---|-----------------------------------|--|
| ATUM 30XD2 WCM. 06T308                             | ●                      | 30 | 32   | 44     | 147 | 60  | 87  | 60 | 2.4                   | 34.8                   | WCM. 06T308                               | 3010-M3.5x9                       | 82-T10                                     |
| ATUM 31XD2 WCM. 06T308                             | ●                      | 31 | 32   | 44     | 149 | 62  | 89  | 60 | 2.3                   | 35.6                   |   |                                   |  |
| ATUM 32XD2 WCM. 06T308                             | ●                      | 32 | 32   | 44     | 151 | 64  | 91  | 60 | 2.1                   | 36.2                   |   |                                   |  |
| ATUM 33XD2 WCM. 06T308                             | ●                      | 33 | 32   | 44     | 153 | 66  | 93  | 60 | 1.9                   | 36.8                   |   |                                   |  |
| ATUM 34XD2 WCM. 06T308                             | ●                      | 34 | 32   | 44     | 155 | 68  | 95  | 60 | 1.9                   | 37.8                   |   |                                   |  |
| ATUM 35XD2 WCM. 06T308                             | ●                      | 35 | 32   | 44     | 157 | 70  | 97  | 60 | 1.9                   | 38.8                   |   |                                   |  |
| ATUM 36XD2 WCM. 06T308                             | ●                      | 36 | 32   | 44     | 159 | 72  | 99  | 60 | 2                     | 40                     |   |                                   |  |
| ATUM 37XD2 WCM. 06T308                             | ●                      | 37 | 32   | 44     | 161 | 74  | 101 | 60 | 1.8                   | 40.6                   |   |                                   |  |
| ATUM 38XD2 WCM. 06T308                             | ●                      | 38 | 32   | 44     | 163 | 76  | 103 | 60 | 1.5                   | 41                     |   |                                   |  |
| ATUM 39XD2 WCM. 06T308                             | ●                      | 39 | 32   | 44     | 165 | 78  | 105 | 60 | 1.3                   | 41.6                   |   |                                   |  |
| ATUM 40XD2 WCM. 06T308                             | ●                      | 40 | 32   | 44     | 167 | 80  | 107 | 60 | 1                     | 42                     |   |                                   |  |
| ATUM 41XD2 WCM. 06T308                             | ●                      | 41 | 32   | 44     | 169 | 82  | 109 | 60 | 0.8                   | 42.6                   |   |                                   |  |
| ATUM 42XD2 WCM. 06T308                             | ●                      | 42 | 32   | 44     | 171 | 84  | 111 | 60 | 0.5                   | 43                     |   |                                   |  |
| ATUM 43XD2 WCM. 06T308                             | ●                      | 43 | 32   | 44     | 173 | 86  | 113 | 60 | 0.3                   | 43.6                   |   |                                   |  |
| ATUM 44XD2 WCM. 06T308                             | ●                      | 44 | 32   | 44     | 175 | 88  | 115 | 60 | 0                     | 44                     |   |                                   |  |
| ATUM 45XD2 WCM. 080412                             | ●                      | 45 | 40   | 54     | 192 | 90  | 122 | 70 | 3.3                   | 51.6                   | WCM. 080412                               | 4015-M4x11                        | 80-T15                                     |
| ATUM 46XD2 WCM. 080412                             | ●                      | 46 | 40   | 54     | 194 | 92  | 124 | 70 | 3                     | 52                     |   |                                   |  |
| ATUM 47XD2 WCM. 080412                             | ●                      | 47 | 40   | 54     | 196 | 94  | 126 | 70 | 2.8                   | 52.6                   |   |                                   |  |
| ATUM 48XD2 WCM. 080412                             | ●                      | 48 | 40   | 54     | 198 | 96  | 128 | 70 | 2.5                   | 53                     |   |                                   |  |
| ATUM 49XD2 WCM. 080412                             | ●                      | 49 | 40   | 54     | 200 | 98  | 130 | 70 | 2.2                   | 53.4                   |   |                                   |  |
| ATUM 50XD2 WCM. 080412                             | ●                      | 50 | 40   | 54     | 202 | 100 | 132 | 70 | 2                     | 54                     |   |                                   |  |
| ATUM 51XD2 WCM. 080412                             | ●                      | 51 | 40   | 54     | 204 | 102 | 134 | 70 | 1.8                   | 54.6                   |   |                                   |  |
| ATUM 52XD2 WCM. 080412                             | ●                      | 52 | 40   | 54     | 206 | 104 | 136 | 70 | 1.5                   | 55                     |   |                                   |  |
| ATUM 53XD2 WCM. 080412                             | ●                      | 53 | 40   | 54     | 208 | 106 | 138 | 70 | 1.3                   | 55.6                   |   |                                   |  |
| ATUM 54XD2 WCM. 080412                             | ●                      | 54 | 40   | 54     | 210 | 108 | 140 | 70 | 1                     | 56                     |   |                                   |  |
| ATUM 55XD2 WCM. 080412                             | ●                      | 55 | 40   | 54     | 212 | 110 | 142 | 70 | 0.8                   | 56.6                   |   |                                   |  |
| ATUM 56XD2 WCM. 080412                             | ●                      | 56 | 40   | 64     | 214 | 112 | 144 | 70 | 0.5                   | 57                     |   |                                   |  |
| ATUM 57XD2 WCM. 080412                             | ●                      | 57 | 40   | 64     | 216 | 114 | 146 | 70 | 0.3                   | 57.6                   |   |                                   |  |
| ATUM 58XD2 WCM. 080412                             | ●                      | 58 | 40   | 64     | 218 | 116 | 148 | 70 | 0                     | 58                     |   |                                   |  |
| ATUM 59XD2 WCM. 080412                             | ●                      | 59 | 40   | 64     | 220 | 118 | 150 | 70 | 0                     | 59                     |   |                                   |  |
| ATUM 60XD2 WCM. 080412                             | ●                      | 60 | 40   | 64     | 222 | 120 | 152 | 70 | 0                     | 60                     |   |                                   |  |

R: Sağ / Right / Rechts | L: Sol / Left / Links

● Stokta / In Stock / Auf Lager ○ Stokta Yok / Non Stock Item / Kein Lagerartikel, Lieferzeit auf Anfrage

ISO Ucuna Uygunudur. / Compatible with ISO Insert. / Kompatibel mit ISO Wendeplatten.

Takma Uçlu Matkap Kullanım Kılavuzu : S 375 / User's Guide For U-Drills : P 375 | Bedienungsanleitung für Vollbohrer : S 375

Sipariş Örneği/Ordering Example/Bestellbeispiel

1 ad./pcs./stück ATUM 30XD2 WCM. 06T308



Delme Derinliği  
Drilling Depth  
Bohrtiefe

= 3x Çap  
= 3x Diameter  
= 3x Durchmesser

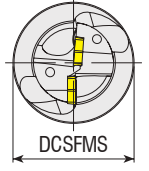
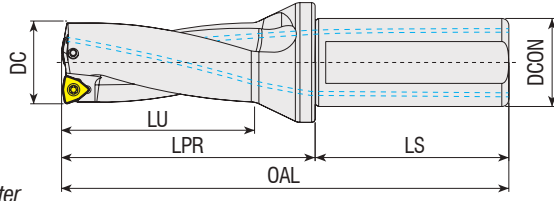

| Takım Kodu<br>Ordering Code<br>Bestell-Bezeichnung | Stok<br>Stock<br>Lager | Takım Ölçüleri (mm)<br>Dimension (mm)<br>Abmessung (mm) |      |        |     |     |     |    | Maks. Ofset (radyal)<br>Max. Ofset (radial)<br>Max. Versatz (radial) |                        | Kesici Uç<br>Insert<br>Wendeschneidplatte | Yedek Parçaları / Spare Parts / Ersatzteile |  |
|--|------------------------|---|------|--------|-----|-----|-----|----|--|------------------------|---|---|--|
|  |                        | DC  | DCON | DCSFMS | OAL | LU  | LPR | LS | X <sub>max</sub>   | DC <sub>max</sub> [mm] |   | Sıkma Vidası<br>Screw<br>Schraube           | Tork Anahtar<br>Torx Key<br>Torx-Schlüssel |
| ATUM 16XD3 WCM. 030208                             | ●                      | 16  | 25   | 34     | 126 | 48  | 70  | 56 | 1.5  | 19                     | WCM. 030208                               | 3008-M2.5x6                                 | 82-T08                                     |
| ATUM 16.5XD3 WCM. 030208                           | ●                      | 16.5  | 25   | 34     | 126 | 48  | 70  | 56 | 1.5  | 19.5                   |   |   |  |
| ATUM 17XD3 WCM. 030208                             | ●                      | 17  | 25   | 34     | 129 | 51  | 73  | 56 | 1.5  | 20                     |   |   |  |
| ATUM 17.5XD3 WCM. 030208                           | ●                      | 17.5  | 25   | 34     | 129 | 51  | 73  | 56 | 1.5  | 20.5                   |   |   |  |
| ATUM 18XD3 WCM. 030208                             | ●                      | 18  | 25   | 34     | 132 | 54  | 76  | 56 | 1.4  | 20.8                   |   |   |  |
| ATUM 18.5XD3 WCM. 030208                           | ●                      | 18.5  | 25   | 34     | 132 | 54  | 76  | 56 | 1.3  | 21.1                   |   |   |  |
| ATUM 19XD3 WCM. 030208                             | ●                      | 19  | 25   | 34     | 135 | 57  | 79  | 56 | 1.2  | 21.4                   |   |   |  |
| ATUM 19.5XD3 WCM. 030208                           | ●                      | 19.5  | 25   | 34     | 135 | 57  | 79  | 56 | 1.2  | 21.9                   |   |   |  |
| ATUM 20XD3 WCM. 040208                             | ●                      | 20  | 25   | 34     | 138 | 60  | 82  | 56 | 1.5  | 23                     | WCM. 040208                               | 3008-M2.5x6                                 | 82-T08                                     |
| ATUM 20.5XD3 WCM. 040208                           | ●                      | 20.5  | 25   | 34     | 138 | 60  | 82  | 56 | 1.5  | 23.5                   |   |   |  |
| ATUM 21XD3 WCM. 040208                             | ●                      | 21  | 25   | 34     | 141 | 63  | 85  | 56 | 1  | 23                     |   |   |  |
| ATUM 21.5XD3 WCM. 040208                           | ●                      | 21.5  | 25   | 34     | 141 | 63  | 85  | 56 | 1  | 23.5                   |   |   |  |
| ATUM 22XD3 WCM. 040208                             | ●                      | 22  | 25   | 34     | 144 | 66  | 88  | 56 | 1  | 24                     |   |   |  |
| ATUM 22.5XD3 WCM. 040208                           | ●                      | 22.5  | 25   | 34     | 144 | 66  | 88  | 56 | 1  | 24.5                   |   |   |  |
| ATUM 23XD3 WCM. 040208                             | ●                      | 23  | 25   | 34     | 147 | 69  | 91  | 56 | 1  | 25                     |   |   |  |
| ATUM 23.5XD3 WCM. 040208                           | ●                      | 23.5  | 25   | 34     | 147 | 69  | 91  | 56 | 1  | 25.5                   |   |   |  |
| ATUM 24XD3 WCM. 050308                             | ●                      | 24  | 25   | 34     | 150 | 72  | 94  | 56 | 1.4  | 26.8                   | WCM. 050308                               | 3008-M3x8                                   |  |
| ATUM 24.5XD3 WCM. 050308                           | ●                      | 24.5  | 25   | 34     | 150 | 72  | 94  | 56 | 1.4  | 27.3                   |   |   |  |
| ATUM 25XD3 WCM. 050308                             | ●                      | 25  | 25   | 34     | 153 | 75  | 97  | 56 | 1.45   | 27.9                   |   |   |  |
| ATUM 25.5XD3 WCM. 050308                           | ●                      | 25.5  | 25   | 34     | 153 | 75  | 97  | 56 | 1.45   | 28.4                   |   |   |  |
| ATUM 26XD3 WCM. 050308                             | ●                      | 26  | 25   | 34     | 156 | 78  | 100 | 56 | 1.45   | 28.9                   |   |   |  |
| ATUM 26.5XD3 WCM. 050308                           | ●                      | 26.5  | 25   | 34     | 156 | 78  | 100 | 56 | 1.45   | 29.4                   |   |   |  |
| ATUM 27XD3 WCM. 050308                             | ●                      | 27  | 25   | 34     | 159 | 81  | 103 | 56 | 1.45   | 29.9                   |   |   |  |
| ATUM 27.5XD3 WCM. 050308                           | ●                      | 27.5  | 25   | 34     | 159 | 81  | 103 | 56 | 1.45   | 30.4                   |   |   |  |
| ATUM 28XD3 WCM. 050308                             | ●                      | 28  | 25   | 34     | 162 | 84  | 106 | 56 | 1.6  | 31.2                   |   |   |  |
| ATUM 28.5XD3 WCM. 050308                           | ●                      | 28.5  | 25   | 34     | 162 | 84  | 106 | 56 | 1.6  | 31.7                   |   |   |  |
| ATUM 29XD3 WCM. 050308                             | ●                      | 29  | 25   | 34     | 165 | 87  | 109 | 56 | 1.65   | 32.3                   |   |   |  |
| ATUM 29.5XD3 WCM. 050308                           | ●                      | 29.5  | 25   | 34     | 165 | 87  | 109 | 56 | 1.65   | 32.8                   |   |   |  |
| ATUM 30XD3 WCM. 06T308                             | ●                      | 30  | 32   | 44     | 177 | 90  | 117 | 60 | 2.4  | 34.8                   | WCM. 06T308                               | 3010-M3.5x9                                 | 82-T10                                     |
| ATUM 30.5XD3 WCM. 06T308                           | ●                      | 30.5  | 32   | 44     | 177 | 90  | 117 | 60 | 2.4  | 35.3                   |   |   |  |
| ATUM 31XD3 WCM. 06T308                             | ●                      | 31  | 32   | 44     | 180 | 93  | 120 | 60 | 2.3  | 35.6                   |   |   |  |
| ATUM 31.5XD3 WCM. 06T308                           | ●                      | 31.5  | 32   | 44     | 180 | 93  | 120 | 60 | 2.3  | 36.1                   |   |   |  |
| ATUM 32XD3 WCM. 06T308                             | ●                      | 32  | 32   | 44     | 183 | 96  | 123 | 60 | 2.1  | 36.2                   |   |   |  |
| ATUM 32.5XD3 WCM. 06T308                           | ●                      | 32.5  | 32   | 44     | 183 | 96  | 123 | 60 | 2.1  | 36.7                   |   |   |  |
| ATUM 33XD3 WCM. 06T308                             | ●                      | 33  | 32   | 44     | 186 | 99  | 126 | 60 | 1.9  | 36.8                   |   |   |  |
| ATUM 33.5XD3 WCM. 06T308                           | ●                      | 33.5  | 32   | 44     | 186 | 99  | 126 | 60 | 1.9  | 37.3                   |   |   |  |
| ATUM 34XD3 WCM. 06T308                             | ●                      | 34  | 32   | 44     | 189 | 102 | 129 | 60 | 1.9  | 37.8                   |   |   |  |
| ATUM 34.5XD3 WCM. 06T308                           | ●                      | 34.5  | 32   | 44     | 189 | 102 | 129 | 60 | 1.9  | 38.3                   |   |   |  |

R: Sağ / Right / Rechts/ L: Sol / Left / Links

● Stokta / In Stock / Auf Lager ○ Stokta Yok / Non Stock Item / Kein Lagerartikel, Lieferzeit auf Anfrage  
ISO Ucuca Uygunudur. / Compatible with ISO Insert. / Kompatibel mit ISO Wendeplatten.

Sipariş Örneği/Ordering Example/Bestellbeispiel

1 ad./pcs./stück ATUM 16XD3 WCM. 030208

Takma Uçlu Matkap Kullanım Kılavuzu : S 375 / User's Guide For U-Drills : P 375

Bedienungsanleitung für Vollbohrer : S 375



Delme Derinliği  
Drilling Depth  
Bohrtiefe

= 3x Çap  
= 3x Diameter  
= 3x Durchmesser

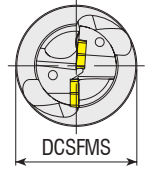
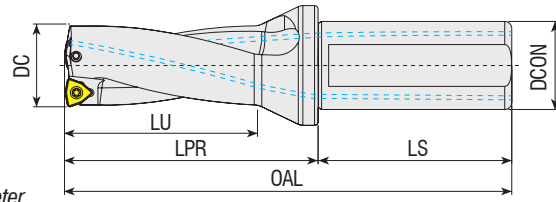

**Takım Kodu**  
**Ordering Code**  
**Bestell-Bezeichnung**

Stok  
Stock  
Lager

Takım Ölçüleri (mm)  
Dimension (mm)  
Abmessung (mm)

Maks. Ofset (radial)  
Max. Offset (radial)  
Max. Versatz (radial)

Kesici Uç  
Insert  
Wendeschneidplatte

Yedek Parçaları / Spare Parts / Ersatzteile

Sıkma Vidası  
Screw  
Schraube

Tork Anahtar  
Torx Key  
Torx-Schlüssel

| DC | DCON | DCSEMS | OAL | LU | LPR | LS | X <sub>max</sub> [mm] | DC <sub>max</sub> [mm] |
|----|------|--------|-----|----|-----|----|-----------------------|------------------------|
|----|------|--------|-----|----|-----|----|-----------------------|------------------------|



|                          |   |      |    |    |     |     |     |    |     |      |             |             |        |
|--------------------------|---|------|----|----|-----|-----|-----|----|-----|------|-------------|-------------|--------|
| ATUM 35XD3 WCM. 06T308   | ● | 35   | 32 | 44 | 192 | 105 | 132 | 60 | 1.9 | 38.8 | WCM. 06T308 | 3010-M3.5x9 | 82-T10 |
| ATUM 35.5XD3 WCM. 06T308 | ● | 35.5 | 32 | 44 | 192 | 105 | 132 | 60 | 1.9 | 39.3 |             |             |        |
| ATUM 36XD3 WCM. 06T308   | ● | 36   | 32 | 44 | 195 | 108 | 135 | 60 | 2   | 40   |             |             |        |
| ATUM 36.5XD3 WCM. 06T308 | ● | 36.5 | 32 | 44 | 195 | 108 | 135 | 60 | 2   | 40.5 |             |             |        |
| ATUM 37XD3 WCM. 06T308   | ● | 37   | 32 | 44 | 198 | 111 | 138 | 60 | 1.8 | 40.6 |             |             |        |
| ATUM 37.5XD3 WCM. 06T308 | ● | 37.5 | 32 | 44 | 198 | 111 | 138 | 60 | 1.8 | 41.1 |             |             |        |
| ATUM 38XD3 WCM. 06T308   | ● | 38   | 32 | 44 | 201 | 114 | 141 | 60 | 1.5 | 41   |             |             |        |
| ATUM 38.5XD3 WCM. 06T308 | ● | 38.5 | 32 | 44 | 201 | 114 | 141 | 60 | 1.5 | 41.5 |             |             |        |
| ATUM 39XD3 WCM. 06T308   | ● | 39   | 32 | 44 | 204 | 117 | 144 | 60 | 1.3 | 41.6 |             |             |        |
| ATUM 39.5XD3 WCM. 06T308 | ● | 39.5 | 32 | 44 | 204 | 117 | 144 | 60 | 1.3 | 42.1 |             |             |        |
| ATUM 40XD3 WCM. 06T308   | ● | 40   | 32 | 44 | 207 | 120 | 147 | 60 | 1   | 42   |             |             |        |
| ATUM 40.5XD3 WCM. 06T308 | ● | 40.5 | 32 | 44 | 207 | 120 | 147 | 60 | 1   | 42.5 |             |             |        |
| ATUM 41XD3 WCM. 06T308   | ● | 41   | 32 | 44 | 210 | 123 | 150 | 60 | 0.8 | 42.6 |             |             |        |
| ATUM 41.5XD3 WCM. 06T308 | ● | 41.5 | 32 | 44 | 210 | 123 | 150 | 60 | 0.8 | 43.1 |             |             |        |
| ATUM 42XD3 WCM. 06T308   | ● | 42   | 32 | 44 | 213 | 126 | 153 | 60 | 0.5 | 43   |             |             |        |
| ATUM 42.5XD3 WCM. 06T308 | ● | 42.5 | 32 | 44 | 213 | 126 | 153 | 60 | 0.5 | 43.5 |             |             |        |
| ATUM 43XD3 WCM. 06T308   | ● | 43   | 32 | 44 | 216 | 129 | 156 | 60 | 0.3 | 43.6 |             |             |        |
| ATUM 43.5XD3 WCM. 06T308 | ● | 43.5 | 32 | 44 | 216 | 129 | 156 | 60 | 0.3 | 44.1 |             |             |        |
| ATUM 44XD3 WCM. 06T308   | ● | 44   | 32 | 44 | 219 | 132 | 159 | 60 | 0   | 44   |             |             |        |
| ATUM 44.5XD3 WCM. 06T308 | ● | 44.5 | 32 | 44 | 219 | 132 | 159 | 60 | 0   | 44.5 |             |             |        |
| ATUM 45XD3 WCM. 080412   | ● | 45   | 40 | 54 | 237 | 135 | 167 | 70 | 3.3 | 51.6 | WCM. 080412 | 4015-M4x11  | 80-T15 |
| ATUM 45.5XD3 WCM. 080412 | ● | 45.5 | 40 | 54 | 237 | 135 | 167 | 70 | 3.3 | 52.1 |             |             |        |
| ATUM 46XD3 WCM. 080412   | ● | 46   | 40 | 54 | 240 | 138 | 170 | 70 | 3   | 52   |             |             |        |
| ATUM 47XD3 WCM. 080412   | ● | 47   | 40 | 54 | 243 | 141 | 173 | 70 | 2.8 | 52.6 |             |             |        |
| ATUM 48XD3 WCM. 080412   | ● | 48   | 40 | 54 | 246 | 144 | 176 | 70 | 2.5 | 53   |             |             |        |
| ATUM 49XD3 WCM. 080412   | ● | 49   | 40 | 54 | 249 | 147 | 179 | 70 | 2.2 | 53.4 |             |             |        |
| ATUM 50XD3 WCM. 080412   | ● | 50   | 40 | 54 | 252 | 150 | 182 | 70 | 2   | 54   |             |             |        |
| ATUM 51XD3 WCM. 080412   | ● | 51   | 40 | 54 | 255 | 153 | 185 | 70 | 1.8 | 54.6 |             |             |        |
| ATUM 52XD3 WCM. 080412   | ● | 52   | 40 | 54 | 258 | 156 | 188 | 70 | 1.5 | 55   |             |             |        |
| ATUM 53XD3 WCM. 080412   | ● | 53   | 40 | 54 | 261 | 159 | 191 | 70 | 1.3 | 55.6 |             |             |        |
| ATUM 54XD3 WCM. 080412   | ● | 54   | 40 | 54 | 264 | 162 | 194 | 70 | 1   | 56   |             |             |        |
| ATUM 55XD3 WCM. 080412   | ● | 55   | 40 | 54 | 267 | 165 | 197 | 70 | 0.8 | 56.6 |             |             |        |
| ATUM 56XD3 WCM. 080412   | ● | 56   | 40 | 64 | 270 | 168 | 200 | 70 | 0.5 | 57   |             |             |        |
| ATUM 57XD3 WCM. 080412   | ● | 57   | 40 | 64 | 273 | 171 | 203 | 70 | 0.3 | 57.6 |             |             |        |
| ATUM 58XD3 WCM. 080412   | ● | 58   | 40 | 64 | 276 | 174 | 206 | 70 | 0   | 58   |             |             |        |
| ATUM 59XD3 WCM. 080412   | ● | 59   | 40 | 64 | 279 | 177 | 209 | 70 | 0   | 59   |             |             |        |
| ATUM 60XD3 WCM. 080412   | ● | 60   | 40 | 64 | 282 | 180 | 212 | 70 | 0   | 60   |             |             |        |

R: Sağ / Right / Rechts! L: Sol / Left / Links

● Stokta / In Stock / Auf Lager ○ Stokta Yok / Non Stock Item / Kein Lagerartikel, Lieferzeit auf Anfrage  
ISO Ucnuna Uygunudur. / Compatible with ISO Insert. / Kompatibel mit ISO Wendepplatten.

Sipariş Örneği/Ordering Example/Bestellbeispiel

1 ad./pcs./stück ATUM 35XD3 WCM. 06T308

Takma Uçlu Matkap Kullanım Kılavuzu : S 375 / User's Guide For U-Drills : P 375

Bedienungsanleitung für Vollbohrer : S 375



Delme Derinliği  
Drilling Depth  
Bohrtiefe

= 4x Çap  
= 4x Diameter  
= 4x Durchmesser

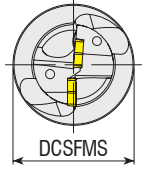
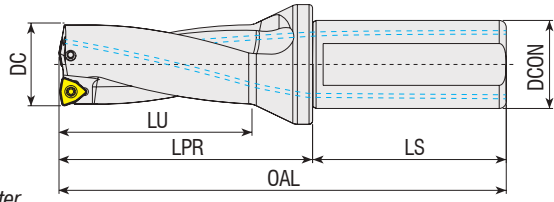

| Takım Kodu<br>Ordering Code<br>Bestell-Bezeichnung | Stok<br>Stock<br>Lager | Takım Ölçüleri (mm)<br>Dimension (mm)<br>Abmessung (mm) |      |        |     |     |     |    | Maks. Ofset (radial)<br>Max. Offset (radial)<br>Max. Versatz (radial) |                        | Kesici Uç<br>Insert<br>Wendeschneidplatte | Yedek Parçaları / Spare Parts / Ersatzteile |  |
|--|------------------------|---|------|--------|-----|-----|-----|----|---|------------------------|---|---|--|
|  |                        | DC  | DCON | DCSFMS | OAL | LU  | LPR | LS | X <sub>max</sub>  | DC <sub>max</sub> [mm] |   | Sıkma Vidası<br>Screw<br>Schraube           | Tork Anahtar<br>Torx Key<br>Torx-Schlüssel |
| ATUM 16XD4 WCM. 030208                             | ●                      | 16  | 25   | 34     | 142 | 64  | 86  | 56 | 1.5   | 19                     | WCM. 030208                               |   |  |
| ATUM 16.5XD4 WCM. 030208                           | ○                      | 16.5  | 25   | 34     | 142 | 64  | 86  | 56 | 1.5   | 19.5                   |   |   |  |
| ATUM 17XD4 WCM. 030208                             | ●                      | 17  | 25   | 34     | 146 | 68  | 90  | 56 | 1.5   | 20                     |   |   |  |
| ATUM 17.5XD4 WCM. 030208                           | ●                      | 17.5  | 25   | 34     | 146 | 68  | 90  | 56 | 1.5   | 20.5                   |   |   |  |
| ATUM 18XD4 WCM. 030208                             | ●                      | 18  | 25   | 34     | 150 | 72  | 94  | 56 | 1.4   | 20.8                   |   |   |  |
| ATUM 18.5XD4 WCM. 030208                           | ○                      | 18.5  | 25   | 34     | 150 | 72  | 94  | 56 | 1.3   | 21.1                   |   |   |  |
| ATUM 19XD4 WCM. 030208                             | ●                      | 19  | 25   | 34     | 154 | 76  | 98  | 56 | 1.2   | 21.4                   |   |   |  |
| ATUM 19.5XD4 WCM. 030208                           | ○                      | 19.5  | 25   | 34     | 154 | 76  | 98  | 56 | 1.2   | 21.9                   |   |   |  |
| ATUM 20XD4 WCM. 040208                             | ●                      | 20  | 25   | 34     | 158 | 80  | 102 | 56 | 1.5   | 23                     | WCM. 040208                               | 3008-M2.5x6                                 | 82-T08                                     |
| ATUM 20.5XD4 WCM. 040208                           | ○                      | 20.5  | 25   | 34     | 158 | 80  | 102 | 56 | 1.5   | 23.5                   |   |   |  |
| ATUM 21XD4 WCM. 040208                             | ●                      | 21  | 25   | 34     | 162 | 84  | 106 | 56 | 1   | 23                     |   |   |  |
| ATUM 21.5XD4 WCM. 040208                           | ○                      | 21.5  | 25   | 34     | 162 | 84  | 106 | 56 | 1   | 23.5                   |   |   |  |
| ATUM 22XD4 WCM. 040208                             | ●                      | 22  | 25   | 34     | 166 | 88  | 110 | 56 | 1   | 24                     |   |   |  |
| ATUM 22.5XD4 WCM. 040208                           | ●                      | 22.5  | 25   | 34     | 166 | 88  | 110 | 56 | 1   | 24.5                   |   |   |  |
| ATUM 23XD4 WCM. 040208                             | ●                      | 23  | 25   | 34     | 170 | 92  | 114 | 56 | 1   | 25                     |   |   |  |
| ATUM 23.5XD4 WCM. 040208                           | ○                      | 23.5  | 25   | 34     | 170 | 92  | 114 | 56 | 1   | 25.5                   |   |   |  |
| ATUM 24XD4 WCM. 050308                             | ●                      | 24  | 25   | 34     | 174 | 96  | 118 | 56 | 1.4   | 26.8                   | WCM. 050308                               | 3008-M3x8                                   |  |
| ATUM 24.5XD4 WCM. 050308                           | ○                      | 24.5  | 25   | 34     | 174 | 96  | 118 | 56 | 1.4   | 27.3                   |   |   |  |
| ATUM 25XD4 WCM. 050308                             | ●                      | 25  | 25   | 34     | 178 | 100 | 122 | 56 | 1.45  | 27.9                   |   |   |  |
| ATUM 25.5XD4 WCM. 050308                           | ○                      | 25.5  | 25   | 34     | 178 | 100 | 122 | 56 | 1.45  | 28.4                   |   |   |  |
| ATUM 26XD4 WCM. 050308                             | ●                      | 26  | 25   | 34     | 182 | 104 | 126 | 56 | 1.45  | 28.9                   |   |   |  |
| ATUM 26.5XD4 WCM. 050308                           | ●                      | 26.5  | 25   | 34     | 182 | 104 | 126 | 56 | 1.45  | 29.4                   |   |   |  |
| ATUM 27XD4 WCM. 050308                             | ●                      | 27  | 25   | 34     | 186 | 108 | 130 | 56 | 1.45  | 29.9                   |   |   |  |
| ATUM 27.5XD4 WCM. 050308                           | ○                      | 27.5  | 25   | 34     | 186 | 108 | 130 | 56 | 1.45  | 30.4                   |   |   |  |
| ATUM 28XD4 WCM. 050308                             | ●                      | 28  | 25   | 34     | 190 | 112 | 134 | 56 | 1.6   | 31.2                   |   |   |  |
| ATUM 28.5XD4 WCM. 050308                           | ●                      | 28.5  | 25   | 34     | 190 | 112 | 134 | 56 | 1.6   | 31.7                   |   |   |  |
| ATUM 29XD4 WCM. 050308                             | ●                      | 29  | 25   | 34     | 194 | 116 | 138 | 56 | 1.65  | 32.3                   |   |   |  |
| ATUM 29.5XD4 WCM. 050308                           | ○                      | 29.5  | 25   | 34     | 194 | 116 | 138 | 56 | 1.65  | 32.8                   |   |   |  |

R: Sağ / Right / Rechts/ L: Sol / Left / Links

● Stokta / In Stock / Auf Lager ○ Stokta Yok / Non Stock Item / Kein Lagerartikel, Lieferzeit auf Anfrage  
ISO Ucuna Uygun. / Compatible with ISO Insert. / Kompatibel mit ISO Wendepfetten.

Sipariş Örneği/Ordering Example/Bestellbeispiel

1 ad./pcs./stück ATUM 16XD4 WCM. 030208

Takma Uçlu Matkap Kullanım Kılavuzu : S 375 / User's Guide For U-Drills : P 375

Bedienungsanleitung für Vollbohrer : S 375





Delme Derinliği  
Drilling Depth  
Bohrtiefe

= 4x Çap  
= 4x Diameter  
= 4x Durchmesser

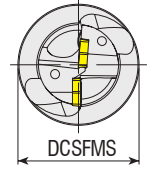
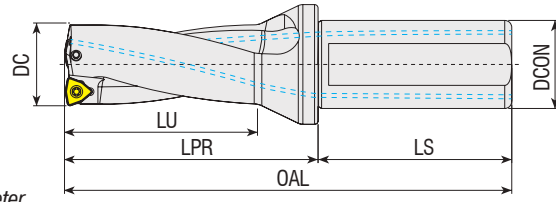

**Takım Kodu**  
**Ordering Code**  
Bestell-Bezeichnung

Stok  
Stock  
Lager

Takım Ölçüleri (mm)  
Dimension (mm)  
Abmessung (mm)

Maks. Ofset (radyal)  
Max. Offset (radial)  
Max. Versatz (radial)

Kesici Uç  
Insert  
Wendeschneidplatte

Yedek Parçaları / Spare Parts / Ersatzteile

Sıkma Vidası  
Screw  
Schraube

Tork Anahtar  
Torx Key  
Torx-Schlüssel

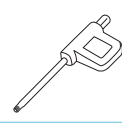

| Takım Kodu<br>Ordering Code<br>Bestell-Bezeichnung | Stok<br>Stock<br>Lager | Takım Ölçüleri (mm)<br>Dimension (mm)<br>Abmessung (mm) |      |        |     |     |     |    | Maks. Ofset (radyal)<br>Max. Offset (radial)<br>Max. Versatz (radial) |                           | Kesici Uç<br>Insert<br>Wendeschneidplatte | Sıkma Vidası<br>Screw<br>Schraube | Tork Anahtar<br>Torx Key<br>Torx-Schlüssel |
|--|------------------------|---|------|--------|-----|-----|-----|----|---|---------------------------|---|-----------------------------------|--|
|  |                        | DC  | DCON | DCSFMS | OAL | LU  | LPR | LS | X <sub>max</sub><br>[mm]  | DC <sub>max</sub><br>[mm] |   |                                   |  |
| ATUM 30XD4 WCM. 06T308                             | ●                      | 30  | 32   | 44     | 207 | 120 | 147 | 60 | 2.4   | 34.8                      | WCM. 06T308                               | 3010-M3.5x9                       | 82-T10                                     |
| ATUM 31XD4 WCM. 06T308                             | ●                      | 31  | 32   | 44     | 211 | 124 | 151 | 60 | 2.3   | 35.6                      |   |                                   |  |
| ATUM 32XD4 WCM. 06T308                             | ●                      | 32  | 32   | 44     | 215 | 128 | 155 | 60 | 2.1   | 36.2                      |   |                                   |  |
| ATUM 33XD4 WCM. 06T308                             | ●                      | 33  | 32   | 44     | 219 | 132 | 159 | 60 | 1.9   | 36.8                      |   |                                   |  |
| ATUM 33.5XD4 WCM. 06T308                           | ●                      | 33.5  | 32   | 44     | 219 | 132 | 159 | 60 | 1.9   | 37.3                      |   |                                   |  |
| ATUM 34XD4 WCM. 06T308                             | ●                      | 34  | 32   | 44     | 223 | 136 | 163 | 60 | 1.9   | 37.8                      |   |                                   |  |
| ATUM 35XD4 WCM. 06T308                             | ●                      | 35  | 32   | 44     | 227 | 140 | 167 | 60 | 1.9   | 38.8                      |   |                                   |  |
| ATUM 36XD4 WCM. 06T308                             | ●                      | 36  | 32   | 44     | 231 | 144 | 171 | 60 | 2   | 40                        |   |                                   |  |
| ATUM 37XD4 WCM. 06T308                             | ●                      | 37  | 32   | 44     | 235 | 148 | 175 | 60 | 1.8   | 40.6                      |   |                                   |  |
| ATUM 38XD4 WCM. 06T308                             | ●                      | 38  | 32   | 44     | 239 | 152 | 179 | 60 | 1.5   | 41                        |   |                                   |  |
| ATUM 38.5XD4 WCM. 06T308                           | ●                      | 38.5  | 32   | 44     | 239 | 152 | 179 | 60 | 1.5   | 41.5                      |   |                                   |  |
| ATUM 39XD4 WCM. 06T308                             | ●                      | 39  | 32   | 44     | 243 | 156 | 183 | 60 | 1.3   | 41.6                      |   |                                   |  |
| ATUM 40XD4 WCM. 06T308                             | ●                      | 40  | 32   | 44     | 247 | 160 | 187 | 60 | 1   | 42                        |   |                                   |  |
| ATUM 41XD4 WCM. 06T308                             | ●                      | 41  | 32   | 44     | 251 | 164 | 191 | 60 | 0.8   | 42.6                      |   |                                   |  |
| ATUM 42XD4 WCM. 06T308                             | ●                      | 42  | 32   | 44     | 255 | 168 | 195 | 60 | 0.5   | 43                        |   |                                   |  |
| ATUM 43XD4 WCM. 06T308                             | ●                      | 43  | 32   | 44     | 259 | 172 | 199 | 60 | 0.3   | 43.6                      |   |                                   |  |
| ATUM 44XD4 WCM. 06T308                             | ●                      | 44  | 32   | 44     | 263 | 176 | 203 | 60 | 0   | 44                        |   |                                   |  |
| ATUM 45XD4 WCM. 080412                             | ●                      | 45  | 40   | 54     | 282 | 180 | 212 | 70 | 3.3   | 51.6                      | WCM. 080412                               | 4015-M4x11                        | 80-T15                                     |
| ATUM 46XD4 WCM. 080412                             | ●                      | 46  | 40   | 54     | 286 | 184 | 216 | 70 | 3   | 52                        |   |                                   |  |
| ATUM 47XD4 WCM. 080412                             | ●                      | 47  | 40   | 54     | 290 | 188 | 220 | 70 | 2.8   | 52.6                      |   |                                   |  |
| ATUM 48XD4 WCM. 080412                             | ●                      | 48  | 40   | 54     | 294 | 192 | 224 | 70 | 2.5   | 53                        |   |                                   |  |
| ATUM 49XD4 WCM. 080412                             | ●                      | 49  | 40   | 54     | 298 | 196 | 228 | 70 | 2.2   | 53.4                      |   |                                   |  |
| ATUM 50XD4 WCM. 080412                             | ●                      | 50  | 40   | 54     | 302 | 200 | 232 | 70 | 2   | 54                        |   |                                   |  |

R: Sağ / Right / Rechtsl L: Sol / Left / Links

● Stokta / In Stock / Auf Lager ○ Stokta Yok / Non Stock Item / Kein Lagerartikel, Lieferzeit auf Anfrage

ISO Ucuna Uygunudur. / Compatible with ISO Insert. / Kompatibel mit ISO Wendeplatten.

Sipariş Örneği/Ordering Example/Bestellbeispiel

1 ad./pcs./stück ATUM 30XD4 WCM. 06T308

Takma Uçlu Matkap Kullanım Kılavuzu : S 375 / User's Guide For U-Drills : P 375

Bedienungsanleitung für Vollbohrer : S 375



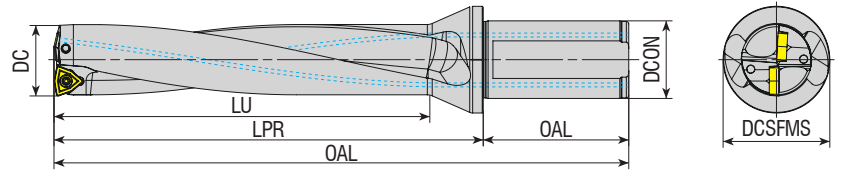

Delme Derinliği  
Drilling Depth  
Bohrtiefe  
= 5x Çap  
= 5x Diameter  
= 5x Durchmesser

| Takım Kodu<br>Ordering Code<br>Bestell-Bezeichnung | Stok<br>Stock<br>Lager | Takım Ölçüleri (mm)<br>Dimension (mm)<br>Abmessung (mm) |      |        |     |     |     |    | Maks. Ofset (radyal)<br>Max. Offset (radial)<br>Max. Versatz (radial) |                   | Kesici Uç<br>Insert<br>Wendeschneidplatte | Yedek Parçaları / Spare Parts / Ersatzteile |  |
|--|------------------------|---|------|--------|-----|-----|-----|----|---|-------------------|---|---|--|
|  |                        | DC  | DCON | DCSFMS | OAL | LU  | LPR | LS | X <sub>max</sub>  | DC <sub>max</sub> |   | Sıkma Vidası<br>Screw<br>Schraube           | Tork Anahtar<br>Torx Key<br>Torx-Schlüssel |
| ATUM 20XD5 WCM. 040208                             | ●                      | 20  | 25   | 34     | 178 | 100 | 122 | 56 | 1.5   | 23                | WCM. 040208                               | 3008-M2.5x6                                 | 82-T08                                     |
| ATUM 21XD5 WCM. 040208                             | ●                      | 21  | 25   | 34     | 183 | 105 | 127 | 56 | 1   | 23                |   |   |  |
| ATUM 22XD5 WCM. 040208                             | ●                      | 22  | 25   | 34     | 188 | 110 | 132 | 56 | 1   | 24                |   |   |  |
| ATUM 23XD5 WCM. 040208                             | ●                      | 23  | 25   | 34     | 193 | 115 | 137 | 56 | 1   | 25                |   |   |  |
| ATUM 24XD5 WCM. 050308                             | ●                      | 24  | 25   | 34     | 198 | 120 | 142 | 56 | 1.4   | 26.8              | WCM. 050308                               | 3008-M3x8                                   | 82-T08                                     |
| ATUM 25XD5 WCM. 050308                             | ●                      | 25  | 25   | 34     | 203 | 125 | 147 | 56 | 1.45  | 27.9              |   |   |  |
| ATUM 26XD5 WCM. 050308                             | ●                      | 26  | 25   | 34     | 208 | 130 | 152 | 56 | 1.45  | 28.9              |   |   |  |
| ATUM 27XD5 WCM. 050308                             | ●                      | 27  | 25   | 34     | 213 | 135 | 157 | 56 | 1.45  | 29.9              |   |   |  |
| ATUM 28XD5 WCM. 050308                             | ●                      | 28  | 25   | 34     | 218 | 140 | 162 | 56 | 1.6   | 31.2              |   |   |  |
| ATUM 29XD5 WCM. 050308                             | ●                      | 29  | 25   | 34     | 223 | 145 | 167 | 56 | 1.65  | 32.3              |   |   |  |
| ATUM 30XD5 WCM. 06T308                             | ●                      | 30  | 32   | 44     | 237 | 150 | 177 | 60 | 2.4   | 34.8              | WCM. 06T308                               | 3010-M3.5x9                                 | 82-T10                                     |
| ATUM 31XD5 WCM. 06T308                             | ●                      | 31  | 32   | 44     | 242 | 155 | 182 | 60 | 2.3   | 35.6              |   |   |  |
| ATUM 32XD5 WCM. 06T308                             | ●                      | 32  | 32   | 44     | 247 | 160 | 187 | 60 | 2.1   | 36.2              |   |   |  |
| ATUM 33XD5 WCM. 06T308                             | ●                      | 33  | 32   | 44     | 252 | 165 | 192 | 60 | 1.9   | 36.8              |   |   |  |
| ATUM 34XD5 WCM. 06T308                             | ●                      | 34  | 32   | 44     | 257 | 170 | 197 | 60 | 1.9   | 37.8              |   |   |  |
| ATUM 35XD5 WCM. 06T308                             | ●                      | 35  | 32   | 44     | 262 | 175 | 202 | 60 | 1.9   | 38.8              |   |   |  |
| ATUM 37XD5 WCM. 06T308                             | ●                      | 37  | 32   | 44     | 272 | 185 | 212 | 60 | 1.8   | 40.6              |   |   |  |
| ATUM 38XD5 WCM. 06T308                             | ●                      | 38  | 32   | 44     | 277 | 190 | 217 | 60 | 1.5   | 41                |   |   |  |
| ATUM 46XD5 WCM. 080412                             | ●                      | 46  | 40   | 54     | 332 | 230 | 262 | 70 | 3   | 52                | WCM. 080412                               | 4015-M4x11                                  | 80-T15                                     |

R: Sağ / Right / Rechts / L: Sol / Left / Links

● Stokta / In Stock / Auf Lager ○ Stokta Yok / Non Stock Item / Kein Lagerartikel, Lieferzeit auf Anfrage

ISO Uçuna Uygundur. / Compatible with ISO Insert. / Kompatibel mit ISO Wendepplatten.

Sipariş Örneği/Ordering Example/Bestellbeispiel

1 ad./pcs./stück ATUM 20XD5 WCM. 040208

Takma Uçlu Matkap Kullanım Kılavuzu : S 375 / User's Guide For U-Drills : P 375

Bedienungsanleitung für Vollbohrer : S 375



Delme Derinliği  
Drilling Depth  
Bohrtiefe  
= 2x Çap  
= 2x Diameter  
= 2x Durchmesser

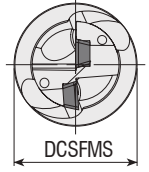
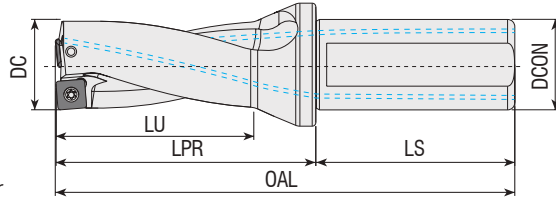

| Takım Kodu<br>Ordering Code<br>Bestell-Bezeichnung | Stok<br>Stock<br>Lager | Takım Ölçüleri (mm)<br>Dimension (mm)<br>Abmessung (mm) |      |        |     |    |     |    | Maks. Ofset (radial)<br>Max. Offset (radial)<br>Max. Versatz (radial) |                   | Kesici Uç<br>Insert<br>Wendeschneidplatte | Yedek Parçaları / Spare Parts / Ersatzteile |  |
|--|------------------------|---|------|--------|-----|----|-----|----|---|-------------------|---|---|--|
|  |                        | DC  | DCON | DCSFMS | OAL | LU | LPR | LS | X <sub>max</sub>  | DC <sub>max</sub> |   | Sıkma Vidası<br>Screw<br>Schraube           | Tork Anahtar<br>Torx Key<br>Torx-Schlüssel |
| ATUM 12.5XD2 SP. 050204                            | ●                      | 12.5  | 20   | 25     | 96  | 24 | 46  | 50 | 0.75  | 14                | SP. 050204                                | 3006-M2x4                                   | 82-T06                                     |
| ATUM 13XD2 SP. 050204                              | ●                      | 13  | 20   | 25     | 98  | 26 | 48  | 50 | 0.75  | 14.5              |   |   |  |
| ATUM 13.5XD2 SP. 050204                            | ●                      | 13.5  | 20   | 25     | 98  | 26 | 48  | 50 | 0.75  | 15                |   |   |  |
| ATUM 14XD2 SP. 050204                              | ●                      | 14  | 20   | 25     | 100 | 28 | 50  | 50 | 0.6   | 15.2              |   |   |  |
| ATUM 14.5XD2 SP. 050204                            | ●                      | 14.5  | 20   | 25     | 100 | 28 | 50  | 50 | 0.6   | 15.7              |   |   |  |
| ATUM 15XD2 SP. 050204                              | ●                      | 15  | 20   | 25     | 102 | 30 | 52  | 50 | 0.5   | 16                |   |   |  |
| ATUM 15.5XD2 SP. 060204                            | ●                      | 15.5  | 20   | 25     | 102 | 30 | 52  | 50 | 0.9   | 17.3              | SP. 060204                                | 3007-M2.2x4.6                               | 82-T07                                     |
| ATUM 16XD2 SP. 060204                              | ●                      | 16  | 25   | 34     | 110 | 32 | 54  | 56 | 0.8   | 17.6              |   |   |  |
| ATUM 16.5XD2 SP. 060204                            | ●                      | 16.5  | 25   | 34     | 110 | 32 | 54  | 56 | 0.8   | 18.1              |   |   |  |
| ATUM 17XD2 SP. 060204                              | ●                      | 17  | 25   | 34     | 112 | 34 | 56  | 56 | 0.75  | 18.5              |   |   |  |
| ATUM 17.5XD2 SP. 060204                            | ●                      | 17.5  | 25   | 34     | 112 | 34 | 56  | 56 | 0.75  | 19                |   |   |  |
| ATUM 18XD2 SP. 060204                              | ●                      | 18  | 25   | 34     | 114 | 36 | 58  | 56 | 0.5   | 19                |   |   |  |
| ATUM 18.5XD2 SP. 060204                            | ●                      | 18.5  | 25   | 34     | 114 | 36 | 58  | 56 | 0.5   | 19.5              |   |   |  |
| ATUM 19XD2 SP. 060204                              | ●                      | 19  | 25   | 34     | 116 | 38 | 60  | 56 | 0.3   | 19.6              |   |   |  |
| ATUM 19.5XD2 SP. 060204                            | ●                      | 19.5  | 25   | 34     | 116 | 38 | 60  | 56 | 0.3   | 20.1              |   |   |  |
| ATUM 20XD2 SP. 060204                              | ●                      | 20  | 25   | 34     | 118 | 40 | 62  | 56 | 0   | 20                |   |   |  |
| ATUM 20.5XD2 SP. 060204                            | ●                      | 20.5  | 25   | 34     | 118 | 40 | 62  | 56 | 0   | 20.5              |   |   |  |
| ATUM 21XD2 SP. 060204                              | ●                      | 21  | 25   | 34     | 120 | 42 | 64  | 56 | 0   | 21                |   |   |  |
| ATUM 21.5XD2 SP. 060204                            | ●                      | 21.5  | 25   | 34     | 120 | 42 | 64  | 56 | 0   | 21.5              |   |   |  |
| ATUM 22XD2 SP. 07T308                              | ●                      | 22  | 25   | 34     | 122 | 44 | 66  | 56 | 1   | 24                | SP. 07T308                                | 3008-M2.5x6                                 | 82-T08                                     |
| <b>new</b> ATUM 22XD2 SP. 07T308-32                | ●                      | 22  | 32   | 44     | 131 | 44 | 71  | 60 | 1   | 24                |   |   |  |
| ATUM 22.5XD2 SP. 07T308                            | ●                      | 22.5  | 25   | 34     | 122 | 44 | 66  | 56 | 1   | 24.5              |   |   |  |
| ATUM 23XD2 SP. 07T308                              | ●                      | 23  | 25   | 34     | 124 | 46 | 68  | 56 | 0.75  | 24.5              |   |   |  |
| <b>new</b> ATUM 23XD2 SP. 07T308-32                | ●                      | 23  | 32   | 44     | 133 | 46 | 73  | 60 | 0.75  | 24.5              |   |   |  |
| ATUM 23.5XD2 SP. 07T308                            | ●                      | 23.5  | 25   | 34     | 124 | 46 | 68  | 56 | 0.75  | 25                |   |   |  |
| ATUM 24XD2 SP. 07T308                              | ●                      | 24  | 25   | 34     | 126 | 48 | 70  | 56 | 0.5   | 25                |   |   |  |
| <b>new</b> ATUM 24XD2 SP. 07T308-32                | ●                      | 24  | 32   | 44     | 135 | 48 | 75  | 60 | 0.50  | 25                |   |   |  |
| ATUM 24.5XD2 SP. 07T308                            | ●                      | 24.5  | 25   | 34     | 126 | 48 | 70  | 56 | 0.5   | 25.5              |   |   |  |
| ATUM 25XD2 SP. 07T308                              | ●                      | 25  | 25   | 34     | 128 | 50 | 72  | 56 | 0.25  | 25.5              |   |   |  |
| <b>new</b> ATUM 25XD2 SP. 07T308-32                | ●                      | 25  | 32   | 44     | 137 | 50 | 77  | 60 | 0.25  | 25.5              |   |   |  |
| ATUM 25.5XD2 SP. 07T308                            | ●                      | 25.5  | 25   | 34     | 128 | 50 | 72  | 56 | 0.25  | 26                |   |   |  |
| ATUM 26XD2 SP. 07T308                              | ●                      | 26  | 25   | 34     | 130 | 52 | 74  | 56 | 0   | 26                |   |   |  |
| <b>new</b> ATUM 26XD2 SP. 07T308-32                | ●                      | 26  | 32   | 44     | 139 | 52 | 79  | 60 | 0   | 26                |   |   |  |
| ATUM 26.5XD2 SP. 07T308                            | ●                      | 26.5  | 25   | 34     | 130 | 52 | 74  | 56 | 0   | 26.5              |   |   |  |
| ATUM 27XD2 SP. 07T308                              | ●                      | 27  | 25   | 34     | 132 | 54 | 76  | 56 | 0   | 27                |   |   |  |
| <b>new</b> ATUM 27XD2 SP. 07T308-32                | ●                      | 27  | 32   | 44     | 141 | 54 | 81  | 60 | 0   | 27                |   |   |  |
| ATUM 27.5XD2 SP. 07T308                            | ●                      | 27.5  | 25   | 34     | 132 | 54 | 76  | 56 | 0   | 27.5              |   |   |  |

R: Sağ / Right / Rechtsl L: Sol / Left / Links

● Stokta / In Stock / Auf Lager ○ Stokta Yok / Non Stock Item / Kein Lagerartikel, Lieferzeit auf Anfrage

TGTC Uçuna Uygun. / Compatible with TGTC Insert. / Kompatibel mit TGTC Wendeplatten.

Sipariş Örneği/Ordering Example/Bestellbeispiel

1 ad./pcs./stück ATUM 12.5XD2 SP. 050204

Takma Uçlu Matkap Kullanım Kılavuzu : S 375 / User's Guide For U-Drills : P 375

Bedienungsanleitung für Vollbohrer : S 375



Delme Derinliği  
Drilling Depth  
Bohrtiefe

= 2x Çap  
= 2x Diameter  
= 2x Durchmesser

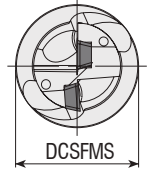
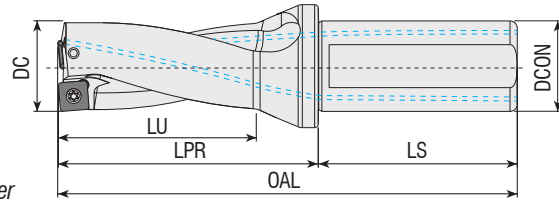

| Takım Kodu<br>Ordering Code<br>Bestell-Bezeichnung | Stok<br>Stock<br>Lager | Takım Ölçüleri (mm)<br>Dimension (mm)<br>Abmessung (mm) |      |        |     |     |     |    | Maks. Ofset (radyal)<br>Max. Offset (radial)<br>Max. Versatz (radial) | Kesici Uç<br>Insert<br>Wendeschneidplatte | Yedek Parçaları / Spare Parts / Ersatzteile |  |        |
|--|------------------------|---|------|--------|-----|-----|-----|----|---|---|---|--|--------|
|  |                        | DC  | DCON | DCSFMS | OAL | LU  | LPR | LS |   |   | Sıkma Vidası<br>Screw<br>Schraube           | Tork Anahtar<br>Torx Key<br>Torx-Schlüssel |        |
| ATUM 28XD2 SP. 090408                              | ●                      | 28  | 25   | 34     | 134 | 56  | 78  | 56 | 1   | 30  | SP. 090408                                  | 4015-M3.5x9                                | 80-T15 |
| new ATUM 28XD2 SP. 090408-32                       | ●                      | 28  | 32   | 44     | 143 | 56  | 83  | 60 | 1   | 29  |   |  |        |
| ATUM 28.5XD2 SP. 090408                            | ●                      | 28.5  | 25   | 34     | 134 | 56  | 78  | 56 | 1   | 30.5                                      |   |  |        |
| ATUM 29XD2 SP. 090408                              | ●                      | 29  | 25   | 34     | 136 | 58  | 80  | 56 | 0.75  | 30.5                                      |   |  |        |
| new ATUM 29XD2 SP. 090408-32                       | ●                      | 29  | 32   | 44     | 145 | 58  | 85  | 60 | 0.75  | 30.5                                      |   |  |        |
| ATUM 29.5XD2 SP. 090408                            | ●                      | 29.5  | 25   | 34     | 136 | 58  | 80  | 56 | 0.75  | 31  |   |  |        |
| ATUM 30XD2 SP. 090408                              | ●                      | 30  | 32   | 44     | 147 | 60  | 87  | 60 | 0.5   | 31  |   |  |        |
| ATUM 31XD2 SP. 090408                              | ●                      | 31  | 32   | 44     | 149 | 62  | 89  | 60 | 0.25  | 31.5                                      |   |  |        |
| ATUM 32XD2 SP. 090408                              | ●                      | 32  | 32   | 44     | 151 | 64  | 91  | 60 | 0   | 32  |   |  |        |
| ATUM 33XD2 SP. 090408                              | ●                      | 33  | 32   | 44     | 153 | 66  | 93  | 60 | 0   | 33  |   |  |        |
| ATUM 34XD2 SP. 110408                              | ●                      | 34  | 32   | 44     | 155 | 68  | 95  | 60 | 1   | 36  | SP. 110408                                  | 4015-M4x11                                 | 80-T15 |
| ATUM 35XD2 SP. 110408                              | ●                      | 35  | 32   | 44     | 157 | 70  | 97  | 60 | 0.75  | 36.5                                      |   |  |        |
| ATUM 36XD2 SP. 110408                              | ●                      | 36  | 32   | 44     | 159 | 72  | 99  | 60 | 0.6   | 37.2                                      |   |  |        |
| ATUM 37XD2 SP. 110408                              | ●                      | 37  | 32   | 44     | 161 | 74  | 101 | 60 | 0.5   | 38  |   |  |        |
| ATUM 38XD2 SP. 110408                              | ●                      | 38  | 32   | 44     | 163 | 76  | 103 | 60 | 0.25  | 38.5                                      |   |  |        |
| ATUM 39XD2 SP. 110408                              | ●                      | 39  | 32   | 44     | 165 | 78  | 105 | 60 | 0   | 39  |   |  |        |
| ATUM 40XD2 SP. 110408                              | ●                      | 40  | 32   | 44     | 167 | 80  | 107 | 60 | 0   | 40  |   |  |        |
| ATUM 41XD2 SP. 110408                              | ●                      | 41  | 32   | 44     | 169 | 82  | 109 | 60 | 0   | 41  |   |  |        |
| ATUM 42XD2 SP. 140512                              | ●                      | 42  | 32   | 44     | 171 | 84  | 111 | 60 | 1.2   | 44.4                                      |   |  |        |
| ATUM 43XD2 SP. 140512                              | ●                      | 43  | 32   | 44     | 173 | 86  | 113 | 60 | 1   | 45  |   |  |        |
| ATUM 44XD2 SP. 140512                              | ●                      | 44  | 32   | 44     | 175 | 88  | 115 | 60 | 0.8   | 45.6                                      |   |  |        |
| ATUM 45XD2 SP. 140512                              | ●                      | 45  | 40   | 54     | 192 | 90  | 122 | 70 | 0.6   | 46.2                                      |   |  |        |
| ATUM 46XD2 SP. 140512                              | ●                      | 46  | 40   | 54     | 194 | 92  | 124 | 70 | 0.4   | 46.8                                      |   |  |        |
| ATUM 47XD2 SP. 140512                              | ●                      | 47  | 40   | 54     | 196 | 94  | 126 | 70 | 0.2   | 47.4                                      |   |  |        |
| ATUM 48XD2 SP. 140512                              | ●                      | 48  | 40   | 54     | 198 | 96  | 128 | 70 | 0   | 48  |   |  |        |
| ATUM 49XD2 SP. 140512                              | ●                      | 49  | 40   | 54     | 200 | 98  | 130 | 70 | 0   | 49  |   |  |        |
| ATUM 50XD2 SP. 140512                              | ●                      | 50  | 40   | 54     | 202 | 100 | 132 | 70 | 0   | 50  |   |  |        |

R: Sağ / Right / Rechts/ L: Sol / Left / Links

● Stokta / In Stock / Auf Lager ○ Stokta Yok / Non Stock Item / Kein Lagerartikel, Lieferzeit auf Anfrage  
TGTC Ucuna Uygunudur. / Compatible with TGTC Insert. / Kompatibel mit TGTC Wendepplatten.

Sipariş Örneği/Ordering Example/Bestellbeispiel  
1 ad./pcs./stück ATUM 28XD2 SP. 090408

Takma Uçlu Matkap Kullanım Kılavuzu : S 375 / User's Guide For U-Drills : P 375  
Bedienungsanleitung für Vollbohrer : S 375



Delme Derinliği  
Drilling Depth  
Bohrtiefe

= 3x Çap  
= 3x Diameter  
= 3x Durchmesser

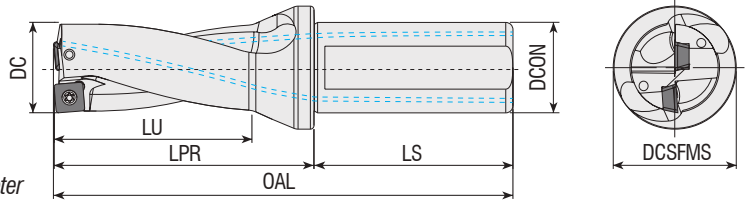

| Takım Kodu<br>Ordering Code<br>Bestell-Bezeichnung | Stok<br>Stock<br>Lager | Takım Ölçüleri (mm)<br>Dimension (mm)<br>Abmessung (mm) |      |        |     |    |     |    | Maks. Ofset (radyal)<br>Max. Offset (radial)<br>Max. Versatz (radial) |   | Kesici Uç<br>Insert<br>Wendeschneidplatte | Yedek Parçaları / Spare Parts / Ersatzteile |  |
|--|------------------------|---|------|--------|-----|----|-----|----|---|---|---|---|--|
|  |                        | DC  | DCON | DCSFMS | OAL | LU | LPR | LS | X <sub>max</sub><br>X <sub>max</sub> [mm]                             | DC <sub>max</sub><br>DC <sub>max</sub> [mm] |   | Sıkma Vidası<br>Screw<br>Schraube           | Tork Anahtar<br>Torx Key<br>Torx-Schlüssel |
| ATUM 12.5XD3 SP. 050204                            | ●                      | 12.5  | 20   | 25     | 108 | 36 | 58  | 50 | 0.75  | 14  | SP. 050204                                | 3006-M2x4                                   | 82-T06                                     |
| ATUM 13XD3 SP. 050204                              | ●                      | 13  | 20   | 25     | 111 | 39 | 61  | 50 | 0.75  | 14.5  |   |   |  |
| ATUM 13.5XD3 SP. 050204                            | ●                      | 13.5  | 20   | 25     | 111 | 39 | 61  | 50 | 0.75  | 15  |   |   |  |
| ATUM 14XD3 SP. 050204                              | ●                      | 14  | 20   | 25     | 114 | 42 | 64  | 50 | 0.6   | 15.2  |   |   |  |
| ATUM 14.5XD3 SP. 050204                            | ●                      | 14.5  | 20   | 25     | 114 | 42 | 64  | 50 | 0.6   | 15.7  |   |   |  |
| ATUM 15XD3 SP. 050204                              | ●                      | 15  | 20   | 25     | 117 | 45 | 67  | 50 | 0.5   | 16  |   |   |  |
| ATUM 15.5XD3 SP. 060204                            | ●                      | 15.5  | 20   | 25     | 117 | 45 | 67  | 50 | 0.9   | 17.3  | SP. 060204                                | 3007-M2.2x4.6                               | 82-T07                                     |
| ATUM 16XD3 SP. 060204                              | ●                      | 16  | 25   | 34     | 126 | 48 | 70  | 56 | 0.8   | 17.6  |   |   |  |
| ATUM 16.5XD3 SP. 060204                            | ●                      | 16.5  | 25   | 34     | 126 | 48 | 70  | 56 | 0.8   | 18.1  |   |   |  |
| ATUM 17XD3 SP. 060204                              | ●                      | 17  | 25   | 34     | 129 | 51 | 73  | 56 | 0.75  | 18.5  |   |   |  |
| ATUM 17.5XD3 SP. 060204                            | ●                      | 17.5  | 25   | 34     | 129 | 51 | 73  | 56 | 0.75  | 19  |   |   |  |
| ATUM 18XD3 SP. 060204                              | ●                      | 18  | 25   | 34     | 132 | 54 | 76  | 56 | 0.5   | 19  |   |   |  |
| ATUM 18.5XD3 SP. 060204                            | ●                      | 18.5  | 25   | 34     | 132 | 54 | 76  | 56 | 0.5   | 19.5  |   |   |  |
| ATUM 19XD3 SP. 060204                              | ●                      | 19  | 25   | 34     | 135 | 57 | 79  | 56 | 0.3   | 19.6  |   |   |  |
| ATUM 19.5XD3 SP. 060204                            | ●                      | 19.5  | 25   | 34     | 135 | 57 | 79  | 56 | 0.3   | 20.1  |   |   |  |
| ATUM 20XD3 SP. 060204                              | ●                      | 20  | 25   | 34     | 138 | 60 | 82  | 56 | 0   | 20  |   |   |  |
| ATUM 20.5XD3 SP. 060204                            | ●                      | 20.5  | 25   | 34     | 138 | 60 | 82  | 56 | 0   | 20.5  |   |   |  |
| ATUM 21XD3 SP. 060204                              | ●                      | 21  | 25   | 34     | 141 | 63 | 85  | 56 | 0   | 21  |   |   |  |
| ATUM 21.5XD3 SP. 060204                            | ●                      | 21.5  | 25   | 34     | 141 | 63 | 85  | 56 | 0   | 21.5  |   |   |  |
| ATUM 22XD3 SP. 07T308                              | ●                      | 22  | 25   | 34     | 144 | 66 | 88  | 56 | 1   | 24  | SP. 07T308                                | 3008-M2.5x6                                 | 82-T08                                     |
| new ATUM 22XD3 SP. 07T308-32                       | ●                      | 22  | 32   | 44     | 153 | 66 | 93  | 60 | 1   | 23  |   |   |  |
| ATUM 22.5XD3 SP. 07T308                            | ●                      | 22.5  | 25   | 34     | 144 | 66 | 88  | 56 | 1   | 24.5  |   |   |  |
| ATUM 23XD3 SP. 07T308                              | ●                      | 23  | 25   | 34     | 147 | 69 | 91  | 56 | 0.75  | 24.5  |   |   |  |
| new ATUM 23XD3 SP. 07T308-32                       | ●                      | 23  | 32   | 44     | 156 | 69 | 96  | 60 | 0.75  | 24.5  |   |   |  |
| ATUM 23.5XD3 SP. 07T308                            | ●                      | 23.5  | 25   | 34     | 147 | 69 | 91  | 56 | 0.75  | 25  |   |   |  |
| ATUM 24XD3 SP. 07T308                              | ●                      | 24  | 25   | 34     | 150 | 72 | 94  | 56 | 0.5   | 25  |   |   |  |
| new ATUM 24XD3 SP. 07T308-32                       | ●                      | 24  | 32   | 44     | 159 | 72 | 99  | 60 | 0.50  | 25  |   |   |  |
| ATUM 24.5XD3 SP. 07T308                            | ●                      | 24.5  | 25   | 34     | 150 | 72 | 94  | 56 | 0.5   | 25.5  |   |   |  |
| ATUM 25XD3 SP. 07T308                              | ●                      | 25  | 25   | 34     | 153 | 75 | 97  | 56 | 0.25  | 25.5  |   |   |  |
| new ATUM 25XD3 SP. 07T308-32                       | ●                      | 25  | 32   | 44     | 162 | 75 | 102 | 60 | 0.25  | 25.5  |   |   |  |
| ATUM 25.5XD3 SP. 07T308                            | ●                      | 25.5  | 25   | 34     | 153 | 75 | 97  | 56 | 0.25  | 26  |   |   |  |
| ATUM 26XD3 SP. 07T308                              | ●                      | 26  | 25   | 34     | 156 | 78 | 100 | 56 | 0   | 26  |   |   |  |
| new ATUM 26XD3 SP. 07T308-32                       | ●                      | 26  | 32   | 44     | 165 | 78 | 105 | 60 | 0   | 26  |   |   |  |
| ATUM 26.5XD3 SP. 07T308                            | ●                      | 26.5  | 25   | 34     | 156 | 78 | 100 | 56 | 0   | 26.5  |   |   |  |
| ATUM 27XD3 SP. 07T308                              | ●                      | 27  | 25   | 34     | 159 | 81 | 103 | 56 | 0   | 27  |   |   |  |
| new ATUM 27XD3 SP. 07T308-32                       | ●                      | 27  | 32   | 44     | 168 | 81 | 108 | 60 | 0   | 27  |   |   |  |
| ATUM 27.5XD3 SP. 07T308                            | ●                      | 27.5  | 25   | 34     | 159 | 81 | 103 | 56 | 0   | 27.5  |   |   |  |
| ATUM 28XD3 SP. 090408                              | ●                      | 28  | 25   | 34     | 162 | 84 | 106 | 56 | 1   | 30  | SP. 090408                                | 4015-M3.5x9                                 | 80-T15                                     |
| new ATUM 28XD3 SP. 090408-32                       | ●                      | 28  | 32   | 44     | 171 | 84 | 111 | 60 | 1   | 29  |   |   |  |
| ATUM 28.5XD3 SP. 090408                            | ●                      | 28.5  | 25   | 34     | 162 | 84 | 106 | 56 | 1   | 30.5  |   |   |  |
| ATUM 29XD3 SP. 090408                              | ●                      | 29  | 25   | 34     | 165 | 87 | 109 | 56 | 0.75  | 30.5  |   |   |  |
| new ATUM 29XD3 SP. 090408-32                       | ●                      | 29  | 32   | 44     | 174 | 87 | 114 | 6  | 0.75  | 30.5  |   |   |  |
| ATUM 29.5XD3 SP. 090408                            | ●                      | 29.5  | 25   | 34     | 165 | 87 | 109 | 56 | 0.75  | 31  |   |   |  |
| ATUM 30XD3 SP. 090408                              | ●                      | 30  | 32   | 44     | 177 | 90 | 117 | 60 | 0.5   | 31  |   |   |  |
| ATUM 30.5XD3 SP. 090408                            | ●                      | 30.5  | 32   | 44     | 177 | 90 | 117 | 60 | 0.5   | 31.5  |   |   |  |
| ATUM 31XD3 SP. 090408                              | ●                      | 31  | 32   | 44     | 180 | 93 | 120 | 60 | 0.25  | 31.5  |   |   |  |
| ATUM 31.5XD3 SP. 090408                            | ●                      | 31.5  | 32   | 44     | 180 | 93 | 120 | 60 | 0.25  | 32  |   |   |  |
| ATUM 32XD3 SP. 090408                              | ●                      | 32  | 32   | 44     | 183 | 96 | 123 | 60 | 0   | 32  |   |   |  |
| ATUM 32.5XD3 SP. 090408                            | ●                      | 32.5  | 32   | 44     | 183 | 96 | 123 | 60 | 0   | 32.5  |   |   |  |
| ATUM 33XD3 SP. 090408                              | ●                      | 33  | 32   | 44     | 186 | 99 | 126 | 60 | 0   | 33  |   |   |  |
| ATUM 33.5XD3 SP. 090408                            | ●                      | 33.5  | 32   | 44     | 186 | 99 | 126 | 60 | 0   | 33.5  |   |   |  |

R: Sağ / Right / Rechts L: Sol / Left / Links

● Stokta / In Stock / Auf Lager ○ Stokta Yok / Non Stock Item / Kein Lagerartikel, Lieferzeit auf Anfrage

TGTC Ucuna Uygun / Compatible with TGTC Insert / Kompatibel mit TGTC Wendeplatten.

Sipariş Örneği/Ordering Example/Bestellbeispiel

1 ad./pcs./stück ATUM 12.5XD3 SP. 050204

Takma Uçlu Matkap Kullanım Kılavuzu : S 375 / User's Guide For U-Drills : P 375

Bedienungsanleitung für Vollbohrer : S 375



Delme Derinliği  
Drilling Depth  
Bohrtiefe  
= 3x Çap  
= 3x Diameter  
= 3x Durchmesser

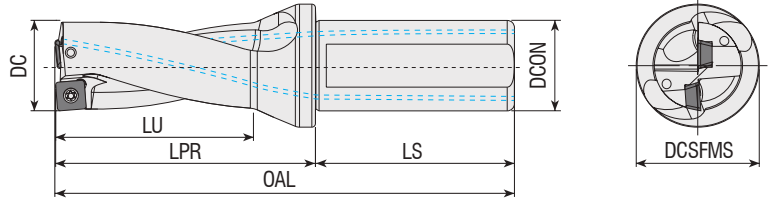

| Takım Kodu<br>Ordering Code<br>Bestell-Bezeichnung | Stok<br>Stock<br>Lager | Takım Ölçüleri (mm)<br>Dimension (mm)<br>Abmessung (mm) |      |        |     |     |     |    | Maks. Ofset (radyal)<br>Max. Offset (radial)<br>Max. Versatz (radial) |                   | Kesici Uç<br>Insert<br>Wendeschneidplatte | Yedek Parçaları / Spare Parts / Ersatzteile |  |
|--|------------------------|---|------|--------|-----|-----|-----|----|---|-------------------|---|---|--|
|  |                        | DC  | DCON | DCSFMS | OAL | LU  | LPR | LS | X <sub>max</sub>  | DC <sub>max</sub> |   | Sıkma Vidası<br>Screw<br>Schraube           | Tork Anahtar<br>Torx Key<br>Torx-Schlüssel |
| ATUM 34XD3 SP. 110408                              | ●                      | 34  | 32   | 44     | 189 | 102 | 129 | 60 | 1   | 36                | SP. 110408                                | 4015-M4x11                                  | 80-T15                                     |
| ATUM 34.5XD3 SP. 110408                            | ●                      | 34.5  | 32   | 44     | 189 | 102 | 129 | 60 | 1   | 36.5              |   |   |  |
| ATUM 35XD3 SP. 110408                              | ●                      | 35  | 32   | 44     | 192 | 105 | 132 | 60 | 0.75  | 36.5              |   |   |  |
| ATUM 35.5XD3 SP. 110408                            | ●                      | 35.5  | 32   | 44     | 192 | 105 | 132 | 60 | 0.75  | 37                |   |   |  |
| ATUM 36XD3 SP. 110408                              | ●                      | 36  | 32   | 44     | 195 | 108 | 135 | 60 | 0.6   | 37.2              |   |   |  |
| ATUM 36.5XD3 SP. 110408                            | ●                      | 36.5  | 32   | 44     | 195 | 108 | 135 | 60 | 0.6   | 37.7              |   |   |  |
| ATUM 37XD3 SP. 110408                              | ●                      | 37  | 32   | 44     | 198 | 111 | 138 | 60 | 0.5   | 38                |   |   |  |
| ATUM 37.5XD3 SP. 110408                            | ●                      | 37.5  | 32   | 44     | 198 | 111 | 138 | 60 | 0.5   | 38.5              |   |   |  |
| ATUM 38XD3 SP. 110408                              | ●                      | 38  | 32   | 44     | 201 | 114 | 141 | 60 | 0.25  | 38.5              |   |   |  |
| ATUM 38.5XD3 SP. 110408                            | ●                      | 38.5  | 32   | 44     | 201 | 114 | 141 | 60 | 0.25  | 39                |   |   |  |
| ATUM 39XD3 SP. 110408                              | ●                      | 39  | 32   | 44     | 204 | 117 | 144 | 60 | 0   | 39                |   |   |  |
| ATUM 39.5XD3 SP. 110408                            | ●                      | 39.5  | 32   | 44     | 204 | 117 | 144 | 60 | 0   | 39.5              |   |   |  |
| ATUM 40XD3 SP. 110408                              | ●                      | 40  | 32   | 44     | 207 | 120 | 147 | 60 | 0   | 40                |   |   |  |
| ATUM 40.5XD3 SP. 110408                            | ●                      | 40.5  | 32   | 44     | 207 | 120 | 147 | 60 | 0   | 40.5              |   |   |  |
| ATUM 41XD3 SP. 110408                              | ●                      | 41  | 32   | 44     | 210 | 123 | 150 | 60 | 0   | 41                |   |   |  |
| ATUM 41.5XD3 SP. 110408                            | ●                      | 41.5  | 32   | 44     | 210 | 123 | 150 | 60 | 0   | 41.5              |   |   |  |
| ATUM 42XD3 SP. 140512                              | ●                      | 42  | 32   | 44     | 213 | 126 | 153 | 60 | 1.2   | 44.4              | SP. 140512                                | 1020-M5x11                                  | 80-T20                                     |
| ATUM 42.5XD3 SP. 140512                            | ●                      | 42.5  | 32   | 44     | 213 | 126 | 153 | 60 | 1.2   | 44.9              |   |   |  |
| ATUM 43XD3 SP. 140512                              | ●                      | 43  | 32   | 44     | 216 | 129 | 156 | 60 | 1   | 45                |   |   |  |
| ATUM 43.5XD3 SP. 140512                            | ●                      | 43.5  | 32   | 44     | 216 | 129 | 156 | 60 | 1   | 45.5              |   |   |  |
| ATUM 44XD3 SP. 140512                              | ●                      | 44  | 32   | 44     | 219 | 132 | 159 | 60 | 0.8   | 45.6              |   |   |  |
| ATUM 44.5XD3 SP. 140512                            | ●                      | 44.5  | 32   | 44     | 219 | 132 | 159 | 60 | 0.8   | 46.1              |   |   |  |
| ATUM 45XD3 SP. 140512                              | ●                      | 45  | 40   | 54     | 237 | 135 | 167 | 70 | 0.6   | 46.2              |   |   |  |
| ATUM 45.5XD3 SP. 140512                            | ●                      | 45.5  | 40   | 54     | 237 | 135 | 167 | 70 | 0.6   | 46.7              |   |   |  |
| ATUM 46XD3 SP. 140512                              | ●                      | 46  | 40   | 54     | 240 | 138 | 170 | 70 | 0.4   | 46.8              |   |   |  |
| ATUM 47XD3 SP. 140512                              | ●                      | 47  | 40   | 54     | 243 | 141 | 173 | 70 | 0.2   | 47.4              |   |   |  |
| ATUM 48XD3 SP. 140512                              | ●                      | 48  | 40   | 54     | 246 | 144 | 176 | 70 | 0   | 48                |   |   |  |
| ATUM 49XD3 SP. 140512                              | ●                      | 49  | 40   | 54     | 249 | 147 | 179 | 70 | 0   | 49                |   |   |  |
| ATUM 50XD3 SP. 140512                              | ●                      | 50  | 40   | 54     | 252 | 150 | 182 | 70 | 0   | 50                |   |   |  |
| ATUM 51XD3 SP. 140512                              | ●                      | 51  | 40   | 54     | 255 | 153 | 185 | 70 | 0   | 51                |   |   |  |
| ATUM 52XD3 SP. 140512                              | ●                      | 52  | 40   | 54     | 258 | 156 | 188 | 70 | 0   | 52                |   |   |  |

R: Sağ / Right / Rechts! L: Sol / Left / Links  
● Stokta / In Stock / Auf Lager ○ Stokta Yok / Non Stock Item / Kein Lagerartikel, Lieferzeit auf Anfrage  
TGTC Ucuna Uygunudur. / Compatible with TGTC Insert. / Kompatibel mit TGTC Wendeplatten.

Sipariş Örneği/Ordering Example/Bestellbeispiel  
1 ad./pcs./stück ATUM 34XD3 SP. 110408  
Takma Uçlu Matkap Kullanım Kılavuzu : S 375 / User's Guide For U-Drills : P 375  
Bedienungsanleitung für Vollbohrer : S 375



Delme Derinliği  
Drilling Depth  
Bohrtiefe

= 4x Çap  
= 4x Diameter  
= 4x Durchmesser

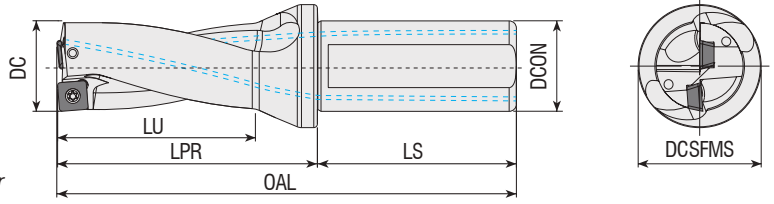

Takım Kodu  
Ordering Code  
Bestell-Bezeichnung

Stok  
Stock  
Lager

Takım Ölçüleri (mm)  
Dimension (mm)  
Abmessung (mm)

Maks. Ofset (radyal)  
Max. Offset (radial)  
Max. Versatz (radial)

Kesici Uç  
Insert  
Wendeschneidplatte

Yedek Parçaları / Spare Parts / Ersatzteile

Sıkma Vidası  
Screw  
Schraube

Tork Anahtar  
Torx Key  
Torx-Schlüssel

DC

DCON

DCSFMS

OAL

LU

LPR

LS

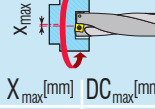

X<sub>max</sub>

DC<sub>max</sub>



| ATUM    | SP.    | DC   | DCON | DCSFMS | OAL | LU  | LPR | LS | X <sub>max</sub> | DC <sub>max</sub> | SP.        | Sıkma Vidası  | Tork Anahtar |            |             |        |
|---------|--------|------|------|--------|-----|-----|-----|----|------------------|-------------------|------------|---------------|--------------|------------|-------------|--------|
| 13XD4   | 050204 | 13   | 20   | 25     | 124 | 52  | 74  | 50 | 0.75             | 14.5              | SP. 050204 | 3006-M2x4     | 82-T06       |            |             |        |
| 14XD4   | 050204 | 14   | 20   | 25     | 128 | 56  | 78  | 50 | 0.6              | 15.2              |            | 3006-M2.5x4   |              |            |             |        |
| 14.5XD4 | 050204 | 14.5 | 20   | 25     | 128 | 56  | 78  | 50 | 0.60             | 15.7              |            |               |              |            |             |        |
| 15XD4   | 050204 | 15   | 20   | 25     | 132 | 60  | 82  | 50 | 0.5              | 16                | SP. 060204 | 3007-M2.2x4.6 | 82-T07       |            |             |        |
| 16XD4   | 060204 | 16   | 25   | 34     | 142 | 64  | 86  | 56 | 0.8              | 17.6              |            |               |              |            |             |        |
| 17XD4   | 060204 | 17   | 25   | 34     | 146 | 68  | 90  | 56 | 0.75             | 18.5              |            |               |              |            |             |        |
| 17.5XD4 | 060204 | 17.5 | 25   | 34     | 146 | 68  | 90  | 56 | 0.75             | 19                |            |               |              |            |             |        |
| 18XD4   | 060204 | 18   | 25   | 34     | 150 | 72  | 94  | 56 | 0.5              | 19                |            |               |              |            |             |        |
| 19XD4   | 060204 | 19   | 25   | 34     | 154 | 76  | 98  | 56 | 0.3              | 19.6              |            |               |              |            |             |        |
| 19.5XD4 | 060204 | 19.5 | 25   | 34     | 154 | 76  | 98  | 56 | 0.3              | 20.1              |            |               |              |            |             |        |
| 20XD4   | 060204 | 20   | 25   | 34     | 158 | 80  | 102 | 56 | 0                | 20                |            |               |              |            |             |        |
| 21XD4   | 060204 | 21   | 25   | 34     | 162 | 84  | 106 | 56 | 0                | 21                |            |               |              |            |             |        |
| 22XD4   | 07T308 | 22   | 25   | 34     | 166 | 88  | 110 | 56 | 1                | 24                |            |               |              | SP. 07T308 | 3008-M2.5x6 | 82-T08 |
| 23XD4   | 07T308 | 23   | 25   | 34     | 170 | 92  | 114 | 56 | 0.75             | 24.5              |            |               |              |            |             |        |
| 23.5XD4 | 07T308 | 23.5 | 25   | 34     | 170 | 92  | 114 | 56 | 0.75             | 25                |            |               |              |            |             |        |
| 24XD4   | 07T308 | 24   | 25   | 34     | 174 | 96  | 118 | 56 | 0.5              | 25                |            |               |              |            |             |        |
| 25XD4   | 07T308 | 25   | 25   | 34     | 178 | 100 | 122 | 56 | 0.25             | 25.5              |            |               |              |            |             |        |
| 26XD4   | 07T308 | 26   | 25   | 34     | 182 | 104 | 126 | 56 | 0                | 26                |            |               |              |            |             |        |
| 27XD4   | 07T308 | 27   | 25   | 34     | 186 | 108 | 130 | 56 | 0                | 27                |            |               |              |            |             |        |
| 27.5XD4 | 07T308 | 27.5 | 25   | 34     | 186 | 108 | 130 | 56 | 0                | 27.5              |            |               |              |            |             |        |
| 28XD4   | 090408 | 28   | 25   | 34     | 190 | 112 | 134 | 56 | 1                | 30                | SP. 090408 | 4015-M3.5x9   | 80-T15       |            |             |        |
| 29XD4   | 090408 | 29   | 25   | 34     | 194 | 116 | 138 | 56 | 0.75             | 30.5              |            |               |              |            |             |        |
| 30XD4   | 090408 | 30   | 32   | 44     | 207 | 120 | 147 | 60 | 0.5              | 31                |            |               |              |            |             |        |
| 31XD4   | 090408 | 31   | 32   | 44     | 211 | 124 | 151 | 60 | 0.25             | 31.5              |            |               |              |            |             |        |
| 32XD4   | 090408 | 32   | 32   | 44     | 215 | 128 | 155 | 60 | 0                | 32                |            |               |              |            |             |        |
| 33XD4   | 090408 | 33   | 32   | 44     | 219 | 132 | 159 | 60 | 0                | 33                |            |               |              |            |             |        |
| 33.5XD4 | 090408 | 33.5 | 32   | 44     | 219 | 132 | 159 | 60 | 0                | 33.5              |            |               |              |            |             |        |
| 34XD4   | 110408 | 34   | 32   | 44     | 223 | 136 | 163 | 60 | 1                | 36                |            |               |              | SP. 110408 | 4015-M4x11  | 80-T15 |
| 35XD4   | 110408 | 35   | 32   | 44     | 227 | 140 | 167 | 60 | 0.75             | 36.5              |            |               |              |            |             |        |
| 36XD4   | 110408 | 36   | 32   | 44     | 231 | 144 | 171 | 60 | 0.6              | 37.2              |            |               |              |            |             |        |
| 37XD4   | 110408 | 37   | 32   | 44     | 235 | 148 | 175 | 60 | 0.5              | 38                |            |               |              |            |             |        |
| 38XD4   | 110408 | 38   | 32   | 44     | 239 | 152 | 179 | 60 | 0.25             | 38.5              |            |               |              |            |             |        |
| 39XD4   | 110408 | 39   | 32   | 44     | 243 | 156 | 183 | 60 | 0                | 39                |            |               |              |            |             |        |
| 40XD4   | 110408 | 40   | 32   | 44     | 247 | 160 | 187 | 60 | 0                | 40                |            |               |              |            |             |        |
| 41XD4   | 110408 | 41   | 32   | 44     | 251 | 164 | 191 | 60 | 0                | 41                |            |               |              |            |             |        |
| 42XD4   | 140512 | 42   | 32   | 44     | 255 | 168 | 195 | 60 | 1.2              | 44.4              | SP. 140512 | 1020-M5x11    | 80-T20       |            |             |        |
| 43XD4   | 140512 | 43   | 32   | 44     | 259 | 172 | 199 | 60 | 1                | 45                |            |               |              |            |             |        |
| 44XD4   | 140512 | 44   | 32   | 44     | 263 | 176 | 203 | 60 | 0.8              | 45.6              |            |               |              |            |             |        |
| 46XD4   | 140512 | 46   | 40   | 54     | 286 | 184 | 216 | 70 | 0.40             | 46.8              |            |               |              |            |             |        |

R: Sağ / Right / Rechts/ L: Sol / Left / Links

● Stokta / In Stock / Auf Lager ○ Stokta Yok / Non Stock Item / Kein Lagerartikel, Lieferzeit auf Anfrage  
TGTC Ucuna Uygunudur. / Compatible with TGTC Insert. / Kompatibel mit TGTC Wendeschneidplatten.

Sipariş Örneği/Ordering Example/Bestellbeispiel

1 ad./pcs./stück ATUM 13XD4 SP. 050204

Takma Uçlu Matkap Kullanım Kılavuzu : S 375 / User's Guide For U-Drills : P 375

Bedienungsanleitung für Vollbohrer : S 375

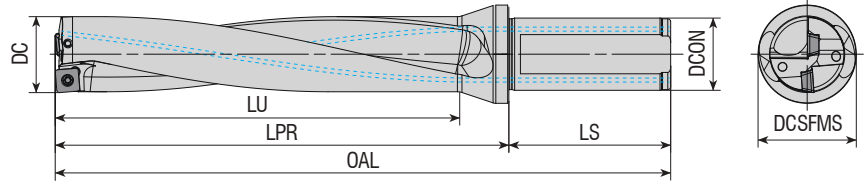

Delme Derinliği  
Drilling Depth  
Bohrtiefe

= 5x Çap  
= 5x Diameter  
= 5x Durchmesser

| Takım Kodu<br>Ordering Code<br>Bestell-Bezeichnung | Stok<br>Stock<br>Lager | Takım Ölçüleri (mm)<br>Dimension (mm)<br>Abmessung (mm) |      |        |     |     |     |    | Maks. Ofset (radial)<br>Max. Offset (radial)<br>Max. Versatz (radial) |                        | Kesici Uç<br>Insert<br>Wendeschneidplatte | Yedek Parçaları / Spare Parts / Ersatzteile |  |
|--|------------------------|---|------|--------|-----|-----|-----|----|---|------------------------|---|---|--|
|  |                        | DC  | DCON | DCSFMS | OAL | LU  | LPR | LS | X <sub>max</sub>  | DC <sub>max</sub> [mm] |   | Sıkma Vidası<br>Screw<br>Schraube           | Tork Anahtar<br>Torx Key<br>Torx-Schlüssel |
| <b>new</b> ATUM 13XD5 SP. 050204                   | ●                      | 13  | 20   | 25     | 137 | 65  | 87  | 50 | 0.75  | 14.5                   | SP. 050204                                | 3006-M2.5x4<br>3006-M2x4                    | 82-T06                                     |
| ATUM 14XD5 SP. 050204                              | ●                      | 14  | 20   | 25     | 142 | 70  | 92  | 50 | 0.6   | 15.2                   |   |   |  |
| <b>new</b> ATUM 14.5XD5 SP. 050204                 | ●                      | 14.5  | 20   | 25     | 142 | 70  | 92  | 50 | 0.60  | 15.7                   |   |   |  |
| <b>new</b> ATUM 15XD5 SP. 050204                   | ●                      | 15  | 20   | 25     | 147 | 75  | 97  | 50 | 0.50  | 16                     | SP. 060204                                | 3006-M2.5x4                                 | 82-T07                                     |
| ATUM 16XD5 SP. 060204                              | ●                      | 16  | 25   | 34     | 158 | 80  | 102 | 56 | 0.8   | 17.6                   |   |   |  |
| ATUM 17XD5 SP. 060204                              | ●                      | 17  | 25   | 34     | 163 | 85  | 107 | 56 | 0.75  | 18.5                   |   |   |  |
| <b>new</b> ATUM 17XD5 SP. 060204-32                | ●                      | 17  | 32   | 34     | 163 | 85  | 107 | 56 | 0.75  | 18.5                   | SP. 060204                                | 3007-M2.2x4.6<br>3007-M2.2x5                | 82-T07                                     |
| ATUM 18XD5 SP. 060204                              | ●                      | 18  | 25   | 34     | 168 | 90  | 112 | 56 | 0.5   | 19                     |   |   |  |
| ATUM 19XD5 SP. 060204                              | ●                      | 19  | 25   | 34     | 173 | 95  | 117 | 56 | 0.3   | 19.6                   |   |   |  |
| ATUM 20XD5 SP. 060204                              | ●                      | 20  | 25   | 34     | 178 | 100 | 122 | 56 | 0   | 20                     | SP. 07T308                                | 3008-M2.5x6                                 | 82-T08                                     |
| ATUM 21XD5 SP. 060204                              | ●                      | 21  | 25   | 34     | 183 | 105 | 127 | 56 | 0   | 21                     |   |   |  |
| ATUM 22XD5 SP. 07T308                              | ●                      | 22  | 25   | 34     | 188 | 110 | 132 | 56 | 1   | 24                     |   |   |  |
| ATUM 22XD5 SP. 07T308-32                           | ●                      | 22  | 32   | 44     | 197 | 110 | 137 | 60 | 1   | 24                     | SP. 07T308                                | 3008-M2.5x6                                 | 82-T08                                     |
| ATUM 23XD5 SP. 07T308                              | ●                      | 23  | 25   | 34     | 193 | 115 | 137 | 56 | 0.75  | 24.5                   |   |   |  |
| ATUM 23XD5 SP. 07T308-32                           | ●                      | 23  | 32   | 44     | 202 | 115 | 142 | 60 | 0.75  | 24.5                   |   |   |  |
| ATUM 24XD5 SP. 07T308-32                           | ●                      | 24  | 32   | 44     | 207 | 120 | 147 | 60 | 0.5   | 25                     | SP. 07T308                                | 3008-M2.5x6                                 | 82-T08                                     |
| ATUM 25XD5 SP. 07T308                              | ●                      | 25  | 25   | 34     | 203 | 125 | 147 | 56 | 0.25  | 25.5                   |   |   |  |
| ATUM 25XD5 SP. 07T308-32                           | ●                      | 25  | 32   | 44     | 212 | 125 | 152 | 60 | 0.25  | 25.5                   |   |   |  |
| ATUM 26XD5 SP. 07T308                              | ●                      | 26  | 25   | 34     | 208 | 130 | 152 | 56 | 0   | 26                     | SP. 07T308                                | 3008-M2.5x6                                 | 82-T08                                     |
| ATUM 26XD5 SP. 07T308-32                           | ●                      | 26  | 32   | 44     | 217 | 130 | 157 | 60 | 0   | 26                     |   |   |  |
| ATUM 27XD5 SP. 07T308                              | ●                      | 27  | 25   | 34     | 213 | 135 | 157 | 56 | 0   | 27                     |   |   |  |
| ATUM 27XD5 SP. 07T308-32                           | ●                      | 27  | 32   | 44     | 222 | 135 | 162 | 60 | 0   | 27                     | SP. 090408                                | 4015-M3.5x9                                 | 80-T15                                     |
| ATUM 28XD5 SP. 090408-32                           | ●                      | 28  | 32   | 44     | 227 | 140 | 167 | 60 | 1   | 30                     |   |   |  |
| ATUM 29XD5 SP. 090408-32                           | ●                      | 29  | 32   | 44     | 232 | 145 | 172 | 60 | 0.75  | 30.5                   |   |   |  |
| ATUM 30XD5 SP. 090408                              | ●                      | 30  | 32   | 44     | 237 | 150 | 177 | 60 | 0.5   | 31                     | SP. 090408                                | 4015-M3.5x9                                 | 80-T15                                     |
| ATUM 31XD5 SP. 090408                              | ●                      | 31  | 32   | 44     | 242 | 155 | 182 | 60 | 0.25  | 31.5                   |   |   |  |
| ATUM 32XD5 SP. 090408                              | ●                      | 32  | 32   | 44     | 247 | 160 | 187 | 60 | 0   | 32                     |   |   |  |
| ATUM 33XD5 SP. 090408                              | ●                      | 33  | 32   | 44     | 252 | 165 | 192 | 60 | 0   | 33                     |   |   |  |

R: Sağ / Right / Rechtsl L: Sol / Left / Links

● Stokta / In Stock / Auf Lager ○ Stokta Yok / Non Stock Item / Kein Lagerartikel, Lieferzeit auf Anfrage  
TGTC Ucuna Uygun / Compatible with TGTC Insert. / Kompatibel mit TGTC Wendeplatten.

Sipariş Örneği/Ordering Example/Bestellbeispiel

1 ad./pcs./stück ATUM 13XD5 SP. 050204

Takma Uçlu Matkap Kullanım Kılavuzu : S 375 / User's Guide For U-Drills : P 375  
Bedienungsanleitung für Vollbohrer : S 375





Delme Derinliği  
Drilling Depth  
Bohrtiefe

= 2x Çap  
= 2x Diameter  
= 2x Durchmesser

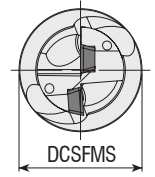
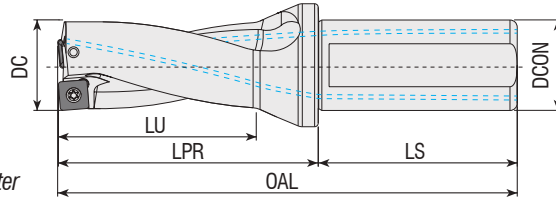

| Takım Kodu<br>Ordering Code<br>Bestell-Bezeichnung | Stok<br>Stock<br>Lager | Takım Ölçüleri (mm)<br>Dimension (mm)<br>Abmessung (mm) |      |        |     |    |     |    | Maks. Ofset (radyal)<br>Max. Offset (radial)<br>Max. Versatz (radial) |                        | Kesici Uç<br>Insert<br>Wendeschneidplatte | Yedek Parçaları / Spare Parts / Ersatzteile |  |
|--|------------------------|---|------|--------|-----|----|-----|----|---|------------------------|---|---|--|
|  |                        | DC  | DCON | DCSFMS | OAL | LU | LPR | LS | X <sub>max</sub>  | DC <sub>max</sub> [mm] |   | Sıkma Vidası<br>Screw<br>Schraube           | Tork Anahtar<br>Torx Key<br>Torx-Schlüssel |
| ATUM 12.5XD2 SPGT 050204                           | ●                      | 12.5  | 20   | 25     | 96  | 24 | 46  | 50 | 0.75  | 14                     | SPGT 050204                               | 3006-M2x4                                   | 82-T06                                     |
| ATUM 13XD2 SPGT 050204                             | ●                      | 13  | 20   | 25     | 98  | 26 | 48  | 50 | 0.75  | 14.5                   |   |   |  |
| ATUM 13.5XD2 SPGT 050204                           | ●                      | 13.5  | 20   | 25     | 98  | 26 | 48  | 50 | 0.75  | 15                     |   |   |  |
| ATUM 14XD2 SPGT 050204                             | ●                      | 14  | 20   | 25     | 100 | 28 | 50  | 50 | 0.6   | 15.2                   |   |   |  |
| ATUM 15XD2 SPGT 050204                             | ●                      | 15  | 20   | 25     | 102 | 30 | 52  | 50 | 0.5   | 16                     |   |   |  |
| ATUM 16XD2 SPGT 060204                             | ●                      | 16  | 25   | 34     | 110 | 32 | 54  | 56 | 0.8   | 17.6                   | SPGT 060204                               | 3007-M2.2x4.6                               | 82-T07                                     |
| ATUM 16.5XD2 SPGT 060204                           | ●                      | 16.5  | 25   | 34     | 110 | 32 | 54  | 56 | 0.8   | 18.1                   |   |   |  |
| ATUM 17XD2 SPGT 060204                             | ●                      | 17  | 25   | 34     | 112 | 34 | 56  | 56 | 0.75  | 18.5                   |   |   |  |
| ATUM 17.5XD2 SPGT 060204                           | ●                      | 17.5  | 25   | 34     | 112 | 34 | 56  | 56 | 0.75  | 19                     |   |   |  |
| ATUM 18XD2 SPGT 060204                             | ●                      | 18  | 25   | 34     | 114 | 36 | 58  | 56 | 0.5   | 19                     |   |   |  |
| ATUM 19XD2 SPGT 060204                             | ●                      | 19  | 25   | 34     | 116 | 38 | 60  | 56 | 0.3   | 19.6                   |   |   |  |
| ATUM 20XD2 SPGT 060204                             | ●                      | 20  | 25   | 34     | 118 | 40 | 62  | 56 | 0   | 20                     |   |   |  |
| new ATUM 21XD2 SPGT 060204                         | ●                      | 21  | 25   | 34     | 120 | 42 | 64  | 56 | 0   | 21                     |   |   |  |
| ATUM 22XD2 SPGT 07T308                             | ●                      | 22  | 25   | 34     | 122 | 44 | 66  | 56 | 1   | 24                     | SPGT 07T308                               | 3008-M2.5x6                                 | 82-T08                                     |
| ATUM 22.5XD2 SPGT 07T308                           | ●                      | 22.5  | 25   | 34     | 122 | 44 | 66  | 56 | 1   | 24.5                   |   |   |  |
| ATUM 23XD2 SPGT 07T308                             | ●                      | 23  | 25   | 34     | 124 | 46 | 68  | 56 | 0.75  | 24.5                   |   |   |  |
| new ATUM 23.5XD2 SPGT 07T308                       | ●                      | 23.5  | 25   | 34     | 124 | 46 | 68  | 56 | 0.75  | 25                     |   |   |  |
| ATUM 24XD2 SPGT 07T308                             | ●                      | 24  | 25   | 34     | 126 | 48 | 70  | 56 | 0.5   | 25                     |   |   |  |
| new ATUM 24.5XD2 SPGT 07T308                       | ●                      | 24.5  | 25   | 34     | 126 | 48 | 70  | 56 | 0.5   | 25.5                   |   |   |  |
| ATUM 25XD2 SPGT 07T308                             | ●                      | 25  | 25   | 34     | 128 | 50 | 72  | 56 | 0.25  | 25.5                   |   |   |  |
| ATUM 26XD2 SPGT 07T308                             | ●                      | 26  | 25   | 34     | 130 | 52 | 74  | 56 | 0   | 26                     |   |   |  |
| ATUM 28XD2 SPGT 090408                             | ●                      | 28  | 25   | 34     | 134 | 56 | 78  | 56 | 1   | 30                     | SPGT 090408                               | 4015-M3.5x9                                 | 80-T15                                     |
| ATUM 29XD2 SPGT 090408                             | ●                      | 29  | 25   | 34     | 136 | 58 | 80  | 56 | 0.75  | 30.5                   |   |   |  |
| ATUM 30XD2 SPGT 090408                             | ●                      | 30  | 32   | 44     | 147 | 60 | 87  | 60 | 0.5   | 31                     |   |   |  |
| new ATUM 31XD2 SPGT 090408                         | ●                      | 31  | 32   | 44     | 149 | 62 | 89  | 60 | 0.25  | 31.5                   |   |   |  |
| ATUM 32XD2 SPGT 090408                             | ●                      | 32  | 32   | 44     | 151 | 64 | 91  | 60 | 0   | 32                     |   |   |  |
| ATUM 35XD2 SPGT 110408                             | ●                      | 35  | 32   | 44     | 157 | 70 | 97  | 60 | 0.75  | 36.5                   | SPGT 110408                               | 4015-M4x11                                  | 80-T15                                     |
| ATUM 36XD2 SPGT 110408                             | ●                      | 36  | 32   | 44     | 159 | 72 | 99  | 60 | 0.6   | 37.2                   |   |   |  |
| ATUM 40XD2 SPGT 110408                             | ●                      | 40  | 32   | 44     | 167 | 80 | 107 | 60 | 0   | 40                     |   |   |  |

R: Sağ / Right / Rechts/ L: Sol / Left / Links  
● Stokta / In Stock / Auf Lager ○ Stokta Yok / Non Stock Item / Kein Lagerartikel, Lieferzeit auf Anfrage  
ZCC Ucuna Uygundur. / Compatible with ZCC Insert. / Kompatibel mit ZCC Wendeplatten.

Sipariş Örneği/Ordering Example/Bestellbeispiel  
1 ad./pcs./stück ATUM 12.5XD2 SPGT 050204  
Takma Uçlu Matkap Kullanım Kılavuzu : S 375 / User's Guide For U-Drills : P 375  
Bedienungsanleitung für Vollbohrer : S 375





Delme Derinliği  
Drilling Depth  
Bohrtiefe

= 3x Çap  
= 3x Diameter  
= 3x Durchmesser

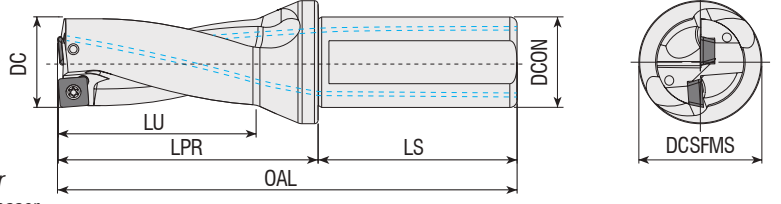

| Takım Kodu<br>Ordering Code<br>Bestell-Bezeichnung | Stok<br>Stock<br>Lager | Takım Ölçüleri (mm)<br>Dimension (mm)<br>Abmessung (mm) |      |        |     |    |     |    | Maks. Ofset (radyal)<br>Max. Offset (radial)<br>Max. Versatz (radial) |                   | Kesici Uç<br>Insert<br>Wendeschneidplatte | Yedek Parçaları / Spare Parts / Ersatzteile |  |
|--|------------------------|---|------|--------|-----|----|-----|----|---|-------------------|---|---|--|
|  |                        | DC  | DCON | DCSFMS | OAL | LU | LPR | LS | X <sub>max</sub>  | DC <sub>max</sub> |   | Sıkma Vidası<br>Screw<br>Schraube           | Tork Anahtar<br>Torx Key<br>Torx-Schlüssel |
| ATUM 12.5XD3 SPGT 050204                           | ●                      | 12.5  | 20   | 25     | 108 | 36 | 58  | 50 | 0.75  | 14                | SPGT 050204                               | 3006-M2x4                                   | 82-T06                                     |
| ATUM 13XD3 SPGT 050204                             | ●                      | 13  | 20   | 25     | 111 | 39 | 61  | 50 | 0.75  | 14.5              |   |   |  |
| ATUM 13.5XD3 SPGT 050204                           | ●                      | 13.5  | 20   | 25     | 111 | 39 | 61  | 50 | 0.75  | 15                |   |   |  |
| ATUM 14XD3 SPGT 050204                             | ●                      | 14  | 20   | 25     | 114 | 42 | 64  | 50 | 0.6   | 15.2              |   |   |  |
| ATUM 14.5XD3 SPGT 050204                           | ●                      | 14.5  | 20   | 25     | 114 | 42 | 64  | 50 | 0.6   | 15.7              |   |   |  |
| ATUM 15XD3 SPGT 050204                             | ●                      | 15  | 20   | 25     | 117 | 45 | 67  | 50 | 0.5   | 16                |   |   |  |
| ATUM 15.5XD3 SPGT 060204                           | ●                      | 15.5  | 20   | 25     | 117 | 45 | 67  | 50 | 0.9   | 17.3              | SPGT 060204                               | 3007-M2.2x4.6                               | 82-T07                                     |
| ATUM 16XD3 SPGT 060204                             | ●                      | 16  | 25   | 34     | 126 | 48 | 70  | 56 | 0.8   | 17.6              |   |   |  |
| ATUM 16.5XD3 SPGT 060204                           | ●                      | 16.5  | 25   | 34     | 126 | 48 | 70  | 56 | 0.8   | 18.1              |   |   |  |
| ATUM 17XD3 SPGT 060204                             | ●                      | 17  | 25   | 34     | 129 | 51 | 73  | 56 | 0.75  | 18.5              |   |   |  |
| ATUM 17.5XD3 SPGT 060204                           | ●                      | 17.5  | 25   | 34     | 129 | 51 | 73  | 56 | 0.75  | 19                |   |   |  |
| ATUM 18XD3 SPGT 060204                             | ●                      | 18  | 25   | 34     | 132 | 54 | 76  | 56 | 0.5   | 19                |   |   |  |
| ATUM 18.5XD3 SPGT 060204                           | ●                      | 18.5  | 25   | 34     | 132 | 54 | 76  | 56 | 0.5   | 19.5              |   |   |  |
| ATUM 19XD3 SPGT 060204                             | ●                      | 19  | 25   | 34     | 135 | 57 | 79  | 56 | 0.3   | 19.6              |   |   |  |
| ATUM 19.5XD3 SPGT 060204                           | ●                      | 19.5  | 25   | 34     | 135 | 57 | 79  | 56 | 0.3   | 20.1              |   |   |  |
| ATUM 20XD3 SPGT 060204                             | ●                      | 20  | 25   | 34     | 138 | 60 | 82  | 56 | 0   | 20                |   |   |  |
| ATUM 20.5XD3 SPGT 060204                           | ●                      | 20.5  | 25   | 34     | 138 | 60 | 82  | 56 | 0   | 20.5              |   |   |  |
| ATUM 21XD3 SPGT 060204                             | ●                      | 21  | 25   | 34     | 141 | 63 | 85  | 56 | 0   | 21                |   |   |  |
| ATUM 21.5XD3 SPGT 060204                           | ●                      | 21.5  | 25   | 34     | 141 | 63 | 85  | 56 | 0   | 21.5              |   |   |  |
| ATUM 22XD3 SPGT 07T308                             | ●                      | 22  | 25   | 34     | 144 | 66 | 88  | 56 | 1   | 24                | SPGT 07T308                               | 3008-M2.5x6                                 | 82-T08                                     |
| ATUM 22.5XD3 SPGT 07T308                           | ●                      | 22.5  | 25   | 34     | 144 | 66 | 88  | 56 | 1   | 24.5              |   |   |  |
| ATUM 23XD3 SPGT 07T308                             | ●                      | 23  | 25   | 34     | 147 | 69 | 91  | 56 | 0.75  | 24.5              |   |   |  |
| ATUM 23.5XD3 SPGT 07T308                           | ●                      | 23.5  | 25   | 34     | 147 | 69 | 91  | 56 | 0.75  | 25                |   |   |  |
| ATUM 24XD3 SPGT 07T308                             | ●                      | 24  | 25   | 34     | 150 | 72 | 94  | 56 | 0.5   | 25                |   |   |  |
| ATUM 24.5XD3 SPGT 07T308                           | ●                      | 24.5  | 25   | 34     | 150 | 72 | 94  | 56 | 0.5   | 25.5              |   |   |  |
| ATUM 25XD3 SPGT 07T308                             | ●                      | 25  | 25   | 34     | 153 | 75 | 97  | 56 | 0.25  | 25.5              |   |   |  |
| ATUM 25.5XD3 SPGT 07T308                           | ●                      | 25.5  | 25   | 34     | 153 | 75 | 97  | 56 | 0.25  | 26                |   |   |  |
| ATUM 26XD3 SPGT 07T308                             | ●                      | 26  | 25   | 34     | 156 | 78 | 100 | 56 | 0   | 26                |   |   |  |
| ATUM 26.5XD3 SPGT 07T308                           | ●                      | 26.5  | 25   | 34     | 156 | 78 | 100 | 56 | 0   | 26.5              |   |   |  |
| ATUM 27XD3 SPGT 07T308                             | ●                      | 27  | 25   | 34     | 159 | 81 | 103 | 56 | 0   | 27                |   |   |  |
| ATUM 27.5XD3 SPGT 07T308                           | ●                      | 27.5  | 25   | 34     | 159 | 81 | 103 | 56 | 0   | 27.5              |   |   |  |
| ATUM 28XD3 SPGT 090408                             | ●                      | 28  | 25   | 34     | 162 | 84 | 106 | 56 | 1   | 30                | SPGT 090408                               | 4015-M3.5x9                                 | 80-T15                                     |
| ATUM 28.5XD3 SPGT 090408                           | ●                      | 28.5  | 25   | 34     | 162 | 84 | 106 | 56 | 1   | 30.5              |   |   |  |
| ATUM 29XD3 SPGT 090408                             | ●                      | 29  | 25   | 34     | 165 | 87 | 109 | 56 | 0.75  | 30.5              |   |   |  |
| ATUM 29.5XD3 SPGT 090408                           | ●                      | 29.5  | 25   | 34     | 165 | 87 | 109 | 56 | 0.75  | 31                |   |   |  |
| ATUM 30XD3 SPGT 090408                             | ●                      | 30  | 32   | 44     | 177 | 90 | 117 | 60 | 0.5   | 31                |   |   |  |
| ATUM 31XD3 SPGT 090408                             | ●                      | 31  | 32   | 44     | 180 | 93 | 120 | 60 | 0.25  | 31.5              |   |   |  |
| ATUM 32XD3 SPGT 090408                             | ●                      | 32  | 32   | 44     | 183 | 96 | 123 | 60 | 0   | 32                |   |   |  |
| ATUM 33XD3 SPGT 090408                             | ●                      | 33  | 32   | 44     | 186 | 99 | 126 | 60 | 0   | 33                |   |   |  |

R: Sağ / Right / Rechts/ L: Sol / Left / Links

● Stokta / In Stock / Auf Lager ○ Stokta Yok / Non Stock Item / Kein Lagerartikel, Lieferzeit auf Anfrage  
ZCC Ucuca Uygun. / Compatible with ZCC Insert. / Kompatibel mit ZCC Wendepfatten.

Sipariş Örneği/Ordering Example/Bestellbeispiel

1 ad./pcs./stück ATUM 12.5XD3 SPGT 050204

Takma Uçlu Matkap Kullanım Kılavuzu : S 375 / User's Guide For U-Drills : P 375

Bedienungsanleitung für Vollbohrer : S 375



Delme Derinliği  
Drilling Depth  
Bohrtiefe  
= 3x Çap  
= 3x Diameter  
= 3x Durchmesser

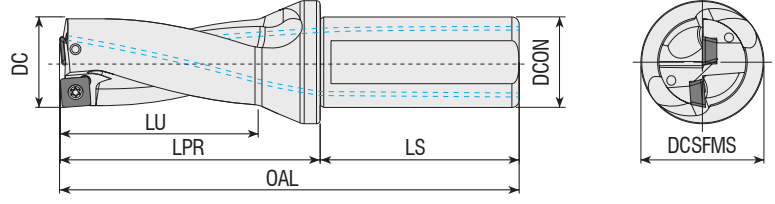

**Takım Kodu**  
**Ordering Code**  
**Bestell-Bezeichnung**

Stok  
Stock  
Lager

Takım Ölçüleri (mm)  
Dimension (mm)  
Abmessung (mm)

Maks. Ofset (radial)  
Max. Offset (radial)  
Max. Versatz (radial)

Kesici Uç  
Insert  
Wendeschneidplatte

Yedek Parçaları / Spare Parts / Ersatzteile

Sıkma Vidası  
Screw  
Schraube

Tork Anahtar  
Torx Key  
Torx-Schlüssel

DC DC CON DCSFMS OAL LU LPR LS

X<sub>max</sub>  
X<sub>max</sub> [mm] DC<sub>max</sub> [mm]

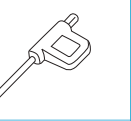
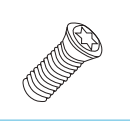

|                                     |   |      |    |    |     |     |     |    |      |      |             |            |        |
|-------------------------------------|---|------|----|----|-----|-----|-----|----|------|------|-------------|------------|--------|
| ATUM 34XD3 SPGT 110408              | ● | 34   | 32 | 44 | 189 | 102 | 129 | 60 | 1    | 36   | SPGT 110408 | 4015-M4x11 | 80-T15 |
| ATUM 35XD3 SPGT 110408              | ● | 35   | 32 | 44 | 192 | 105 | 132 | 60 | 0.75 | 36.5 |             |            |        |
| <b>new</b> ATUM 36XD3 SPGT 110408   | ● | 36   | 32 | 44 | 195 | 108 | 135 | 60 | 2.5  | 41   |             |            |        |
| <b>new</b> ATUM 36.5XD3 SPGT 110408 | ● | 36.5 | 32 | 44 | 195 | 110 | 135 | 60 | 0.6  | 37.7 |             |            |        |
| ATUM 37XD3 SPGT 110408              | ● | 37   | 32 | 44 | 198 | 111 | 138 | 60 | 0.5  | 38   |             |            |        |
| ATUM 38XD3 SPGT 110408              | ● | 38   | 32 | 44 | 201 | 114 | 141 | 60 | 0.25 | 38.5 |             |            |        |
| ATUM 39XD3 SPGT 110408              | ● | 39   | 32 | 44 | 204 | 117 | 144 | 60 | 0    | 39   |             |            |        |
| ATUM 40XD3 SPGT 110408              | ● | 40   | 32 | 44 | 207 | 120 | 147 | 60 | 0    | 40   |             |            |        |
| ATUM 42XD3 SPGT 140512              | ● | 42   | 32 | 44 | 213 | 126 | 153 | 60 | 1.2  | 44.4 | SPGT 140512 | 1020-M5x11 | 80-T20 |
| ATUM 43XD3 SPGT 140512              | ● | 43   | 32 | 44 | 216 | 129 | 156 | 60 | 1    | 45   |             |            |        |
| ATUM 44XD3 SPGT 140512              | ● | 44   | 32 | 44 | 219 | 132 | 159 | 60 | 0.8  | 45.6 |             |            |        |
| ATUM 49XD3 SPGT 140512              | ● | 49   | 40 | 54 | 249 | 147 | 179 | 70 | 0    | 49   |             |            |        |
| ATUM 50XD3 SPGT 140512              | ● | 50   | 40 | 54 | 252 | 150 | 182 | 70 | 0    | 50   |             |            |        |

R: Sağ / Right / Rechts/ L: Sol / Left / Links

● Stokta / In Stock / Auf Lager ○ Stokta Yok / Non Stock Item / Kein Lagerartikel, Lieferzeit auf Anfrage  
ZCC Ucuna Uygun. / Compatible with ZCC Insert. / Kompatibel mit ZCC Wendeplatten.

Sipariş Örneği/Ordering Example/Bestellbeispiel

1 ad./pcs./stück ATUM 34XD3 SPGT 110408

Takma Uçlu Matkap Kullanım Kılavuzu : S 375 / User's Guide For U-Drills : P 375

Bedienungsanleitung für Vollbohrer : S 375





Delme Derinliği  
Drilling Depth  
Bohrtiefe

= 4x Çap  
= 4x Diameter  
= 4x Durchmesser

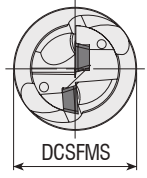
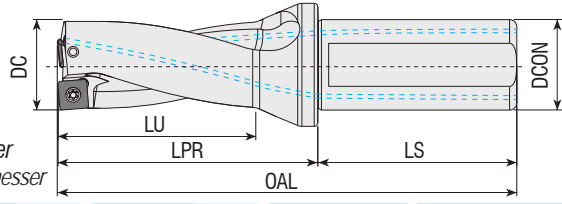

| Takım Kodu<br>Ordering Code<br>Bestell-Bezeichnung | Stok<br>Stock<br>Lager | Takım Ölçüleri (mm)<br>Dimension (mm)<br>Abmessung (mm) |      |        |     |     |     |    |   | Maks. Ofset (radyal)<br>Max. Offset (radial)<br>Max. Versatz (radial) |                                   | Kesici Uç<br>Insert<br>Wendeschneidplatte | Yedek Parçaları / Spare Parts / Ersatzteile |             |
|--|------------------------|---|------|--------|-----|-----|-----|----|---|---|-----------------------------------|---|---|-------------|
|  |                        | DC  | DCON | DCSFMS | OAL | LU  | LPR | LS | X <sub>max</sub><br>X <sub>max</sub> [mm] | DC <sub>max</sub><br>DC <sub>max</sub> [mm]                           | Sıkma Vidası<br>Screw<br>Schraube |   | Tork Anahtar<br>Torx Key<br>Torx-Schlüssel  |             |
| ATUM 13XD4 SPGT 050204                             | ●                      | 13  | 20   | 25     | 124 | 52  | 74  | 50 | 0.75                                      | 14.5  | SPGT 050204                       | 3006-M2x4                                 | 82-T06                                      |             |
| ATUM 14XD4 SPGT 050204                             | ●                      | 14  | 20   | 25     | 128 | 56  | 78  | 50 | 0.6                                       | 15.2  |                                   |   |   |             |
| <b>new</b> ATUM 14.5XD4 SPGT 050204                | ●                      | 14.5  | 20   | 25     | 128 | 58  | 78  | 50 | 0.6                                       | 15.7  |                                   |   |   |             |
| ATUM 15XD4 SPGT 050204                             | ●                      | 15  | 20   | 25     | 132 | 60  | 82  | 50 | 0.5                                       | 16  |                                   |   |   |             |
| ATUM 16XD4 SPGT 060204                             | ●                      | 16  | 25   | 34     | 142 | 64  | 86  | 56 | 0.8                                       | 17.6  | SPGT 060204                       | 3007-M2.2x5                               | 82-T07                                      |             |
| ATUM 17XD4 SPGT 060204                             | ●                      | 17  | 25   | 34     | 146 | 68  | 90  | 56 | 0.75                                      | 18.5  |                                   |   |   |             |
| ATUM 17.5XD4 SPGT 060204                           | ●                      | 17.5  | 25   | 34     | 146 | 68  | 90  | 56 | 0.75                                      | 19  |                                   |   |   |             |
| ATUM 18XD4 SPGT 060204                             | ●                      | 18  | 25   | 34     | 150 | 72  | 94  | 56 | 0.5                                       | 19  |                                   |   |   |             |
| ATUM 19XD4 SPGT 060204                             | ●                      | 19  | 25   | 34     | 154 | 76  | 98  | 56 | 0.3                                       | 19.6  |                                   |   |   |             |
| ATUM 19.5XD4 SPGT 060204                           | ●                      | 19.5  | 25   | 34     | 154 | 76  | 98  | 56 | 0.3                                       | 20.1  |                                   |   |   |             |
| ATUM 20XD4 SPGT 060204                             | ●                      | 20  | 25   | 34     | 158 | 80  | 102 | 56 | 0   | 20  |                                   |   |   |             |
| ATUM 21XD4 SPGT 060204                             | ●                      | 21  | 25   | 34     | 162 | 84  | 106 | 56 | 0   | 21  |                                   |   |   |             |
| ATUM 22XD4 SPGT 07T308                             | ●                      | 22  | 25   | 34     | 166 | 88  | 110 | 56 | 1   | 24  | SPGT 07T308                       | 3008-M2.5x6                               | 82-T08                                      |             |
| ATUM 23XD4 SPGT 07T308                             | ●                      | 23  | 25   | 34     | 170 | 92  | 114 | 56 | 0.75                                      | 24.5  |                                   |   |   |             |
| ATUM 23.5XD4 SPGT 07T308                           | ●                      | 23.5  | 25   | 34     | 170 | 92  | 114 | 56 | 0.75                                      | 25  |                                   |   |   |             |
| ATUM 24XD4 SPGT 07T308                             | ●                      | 24  | 25   | 34     | 174 | 96  | 118 | 56 | 0.5                                       | 25  |                                   |   |   |             |
| ATUM 25XD4 SPGT 07T308                             | ●                      | 25  | 25   | 34     | 178 | 100 | 122 | 56 | 0.25                                      | 25.5  |                                   |   |   |             |
| ATUM 26XD4 SPGT 07T308                             | ●                      | 26  | 25   | 34     | 182 | 104 | 126 | 56 | 0   | 26  |                                   |   |   |             |
| ATUM 27.5XD4 SPGT 07T308                           | ●                      | 27.5  | 25   | 34     | 186 | 108 | 130 | 56 | 0   | 27.5  |                                   |   |   |             |
| ATUM 28XD4 SPGT 090408                             | ●                      | 28  | 25   | 34     | 190 | 112 | 134 | 56 | 1   | 30  |                                   |   |   | SPGT 090408 |
| ATUM 29XD4 SPGT 090408                             | ●                      | 29  | 25   | 34     | 194 | 116 | 138 | 56 | 0.75                                      | 30.5  |                                   |   |   |             |
| ATUM 30XD4 SPGT 090408                             | ●                      | 30  | 32   | 44     | 207 | 120 | 147 | 60 | 0.5                                       | 31  |                                   |   |   |             |
| <b>new</b> ATUM 31XD4 SPGT 090408                  | ●                      | 31  | 32   | 44     | 211 | 124 | 151 | 60 | 0.75                                      | 32.5  |                                   |   |   |             |
| <b>new</b> ATUM 32XD4 SPGT 090408                  | ●                      | 32  | 32   | 44     | 215 | 128 | 155 | 60 | 0   | 32  |                                   |   |   |             |
| ATUM 33.5XD4 SPGT 090408                           | ●                      | 33.5  | 32   | 44     | 219 | 132 | 159 | 60 | 0   | 33.5  |                                   |   |   |             |
| ATUM 38XD4 SPGT 110408                             | ●                      | 38  | 32   | 44     | 239 | 152 | 179 | 60 | 0.25                                      | 38.5  | SPGT 110408                       | 4015-M4x11                                | 80-T15                                      |             |

ZCC Ucuna Uygun. / Compatible with ZCC Insert. / Kompatibel mit ZCC Wendeplatten.

Takma Uçlu Matkap Kullanım Kılavuzu : S 375 / User's Guide For U-Drills : P 375  
Bedienungsanleitung für Vollbohrer : S 375



Delme Derinliği  
Drilling Depth  
Bohrtiefe

= 5x Çap  
= 5x Diameter  
= 5x Durchmesser

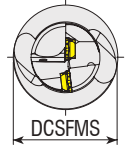
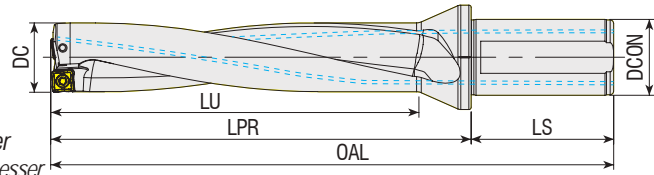

| Takım Kodu<br>Ordering Code<br>Bestell-Bezeichnung | Stok<br>Stock<br>Lager | Takım Ölçüleri (mm)<br>Dimension (mm)<br>Abmessung (mm) |      |        |     |     |     |    |   | Maks. Ofset (radyal)<br>Max. Offset (radial)<br>Max. Versatz (radial) |                                   | Kesici Uç<br>Insert<br>Wendeschneidplatte | Yedek Parçaları / Spare Parts / Ersatzteile |  |
|--|------------------------|---|------|--------|-----|-----|-----|----|---|---|-----------------------------------|---|---|--|
|  |                        | DC  | DCON | DCSFMS | OAL | LU  | LPR | LS | X <sub>max</sub><br>X <sub>max</sub> [mm] | DC <sub>max</sub><br>DC <sub>max</sub> [mm]                           | Sıkma Vidası<br>Screw<br>Schraube |   | Tork Anahtar<br>Torx Key<br>Torx-Schlüssel  |  |
| ATUM 22XD5 SPGT 07T308                             | ●                      | 22  | 25   | 34     | 188 | 110 | 132 | 56 | 1   | 24  | SPGT 07T308                       | 3008-M2.5x6                               | 82-T08                                      |  |
| ATUM 26XD5 SPGT 07T308-32                          | ●                      | 26  | 32   | 44     | 217 | 130 | 157 | 60 | 0   | 26  |                                   |   |   |  |

R: Sağ / Right / Rechts/ L: Sol / Left / Links

● Stokta / In Stock / Auf Lager ○ Stokta Yok / Non Stock Item / Kein Lagerartikel, Lieferzeit auf Anfrage  
ZCC Ucuna Uygun. / Compatible with ZCC Insert. / Kompatibel mit ZCC Wendeplatten. Wendeplatten.

Sipariş Örneği/Ordering Example/Bestellbeispiel  
1 ad./pcs./stück ATUM 13XD4 SPGT 050204

Takma Uçlu Matkap Kullanım Kılavuzu : S 375 / User's Guide For U-Drills : P 375  
Bedienungsanleitung für Vollbohrer : S 375



Delme Derinliği  
Drilling Depth  
Bohrtiefe

= 3x Çap  
= 3x Diameter  
= 3x Durchmesser

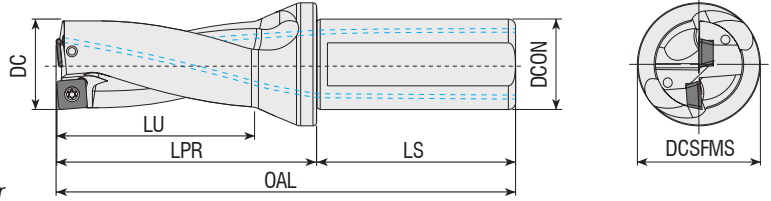

**Takım Kodu**  
**Ordering Code**  
*Bestell-Bezeichnung*

Stok  
Stock  
Lager

Takım Ölçüleri (mm)  
Dimension (mm)  
Abmessung (mm)

Maks. Ofset (radyal)  
Max. Offset (radial)  
Max. Versatz (radial)

Kesici Uç  
Insert  
Wendeschneidplatte

Yedek Parçaları / Spare Parts / Ersatzteile

Sıkma Vidası  
Screw  
Schraube

Tork Anahtar  
Torx Key  
Torx-Schlüssel

| Takım Kodu<br>Ordering Code<br>Bestell-Bezeichnung | Stok<br>Stock<br>Lager | Takım Ölçüleri (mm)<br>Dimension (mm)<br>Abmessung (mm) |      |        |     |     |     |    | Maks. Ofset (radyal)<br>Max. Offset (radial)<br>Max. Versatz (radial) |   | Kesici Uç<br>Insert<br>Wendeschneidplatte | Sıkma Vidası<br>Screw<br>Schraube | Tork Anahtar<br>Torx Key<br>Torx-Schlüssel |
|--|------------------------|---|------|--------|-----|-----|-----|----|---|---|---|-----------------------------------|--|
|  |                        | DC  | DCON | DCSFMS | OAL | LU  | LPR | LS | X <sub>max</sub><br>X <sub>max</sub> [mm]                             | DC <sub>max</sub><br>DC <sub>max</sub> [mm] |   |                                   |  |
| ATUM 14XD3 SO.. 050204                             | ●                      | 14  | 20   | 25     | 114 | 42  | 64  | 50 | 1.4   | 16.8  | SO.. 050204                               | 3006-M2x4                         | 82-T06                                     |
| ATUM 15XD3 SO.. 050204                             | ●                      | 15  | 20   | 25     | 117 | 45  | 67  | 50 | 1.2   | 17.4  |   |                                   |  |
| ATUM 16XD3 SO.. 050204                             | ●                      | 16  | 25   | 34     | 126 | 48  | 70  | 56 | 0.9   | 17.8  |   |                                   |  |
| ATUM 16.5XD3 SO.. 050204                           | ●                      | 16.5  | 25   | 34     | 126 | 48  | 70  | 56 | 0.8   | 18.1  |   |                                   |  |
| ATUM 17XD3 SO.. 050204                             | ●                      | 17  | 25   | 34     | 129 | 51  | 73  | 56 | 0.65  | 18.3  |   |                                   |  |
| ATUM 17.5XD3 SO.. 050204                           | ●                      | 17.5  | 25   | 34     | 129 | 51  | 73  | 56 | 0.5   | 18.5  |   |                                   |  |
| ATUM 18XD3 SO.. 060304                             | ●                      | 18  | 25   | 34     | 132 | 54  | 76  | 56 | 1.15  | 20.3  | SO.. 060304                               | 3007-M2.2x4.6                     | 82-T07                                     |
| ATUM 19XD3 SO.. 060304                             | ●                      | 19  | 25   | 34     | 135 | 57  | 79  | 56 | 0.9   | 20.8  |   |                                   |  |
| ATUM 20XD3 SO.. 060304                             | ●                      | 20  | 25   | 34     | 138 | 60  | 82  | 56 | 0.65  | 21.3  |   |                                   |  |
| ATUM 21XD3 SO.. 070305                             | ●                      | 21  | 25   | 34     | 141 | 63  | 85  | 56 | 1.75  | 24.5  | SO.. 070305                               | 3008-M2.5x6                       | 82-T08                                     |
| ATUM 22XD3 SO.. 070305                             | ●                      | 22  | 25   | 34     | 144 | 66  | 88  | 56 | 1.5   | 25  |   |                                   |  |
| ATUM 22.5XD3 SO.. 070305                           | ●                      | 22.5  | 25   | 34     | 144 | 66  | 88  | 56 | 1.35  | 25.2  |   |                                   |  |
| ATUM 23XD3 SO.. 070305                             | ●                      | 23  | 25   | 34     | 147 | 69  | 91  | 56 | 1.25  | 25.5  |   |                                   |  |
| ATUM 24XD3 SO.. 070305                             | ●                      | 24  | 25   | 34     | 150 | 72  | 94  | 56 | 1   | 26  |   |                                   |  |
| ATUM 25XD3 SO.. 09T306                             | ●                      | 25  | 25   | 34     | 153 | 75  | 97  | 56 | 2.25  | 29.5  |   |                                   |  |
| ATUM 26XD3 SO.. 09T306                             | ●                      | 26  | 25   | 34     | 156 | 78  | 100 | 56 | 2   | 30  | SO.. 09T306                               | 4010-M3x8                         | 82-T10                                     |
| ATUM 27XD3 SO.. 09T306                             | ●                      | 27  | 25   | 34     | 159 | 81  | 103 | 56 | 1.75  | 30.5  |   |                                   |  |
| ATUM 29XD3 SO.. 09T306                             | ●                      | 29  | 25   | 34     | 174 | 87  | 114 | 56 | 1.25  | 31.5  |   |                                   |  |
| ATUM 30XD3 SO.. 09T306                             | ●                      | 30  | 32   | 44     | 177 | 90  | 117 | 60 | 1   | 32  |   |                                   |  |
| ATUM 31XD3 SO.. 09T306                             | ●                      | 31  | 32   | 44     | 200 | 93  | 120 | 60 | 0.75  | 32.5  |   |                                   |  |
| ATUM 33XD3 SO.. 09T306                             | ●                      | 33  | 32   | 44     | 186 | 99  | 126 | 60 | 0.5   | 34  |   |                                   |  |
| ATUM 35XD3 SO.. 120408                             | ●                      | 35  | 32   | 44     | 192 | 105 | 132 | 60 | 2.75  | 40.5  | SO..120408                                | 4015-M4X11                        | 80-T15                                     |
| ATUM 36XD3 SO.. 120408                             | ●                      | 36  | 32   | 44     | 195 | 108 | 135 | 60 | 2.5   | 41  |   |                                   |  |
| ATUM 37XD3 SO.. 120408                             | ●                      | 37  | 32   | 44     | 198 | 111 | 138 | 60 | 2.25  | 41.5  |   |                                   |  |
| ATUM 38XD3 SO.. 120408                             | ●                      | 38  | 32   | 44     | 201 | 114 | 141 | 60 | 1.75  | 41.5  |   |                                   |  |
| ATUM 39XD3 SO.. 120408                             | ●                      | 39  | 32   | 44     | 204 | 117 | 144 | 60 | 1.75  | 42.5  |   |                                   |  |
| ATUM 40XD3 SO.. 120408                             | ●                      | 40  | 32   | 44     | 207 | 120 | 147 | 60 | 1.5   | 43  |   |                                   |  |
| ATUM 43XD3 SO.. 120408                             | ●                      | 43  | 32   | 44     | 216 | 129 | 156 | 60 | 0.75  | 44.5  |   |                                   |  |

R: Sağ / Right / Rechts/ L: Sol / Left / Links

● Stokta / In Stock / Auf Lager ○ Stokta Yok / Non Stock Item / Kein Lagerartikel, Lieferzeit auf Anfrage  
ISCR Ucuna Uygundur. / Compatible with ISCR Insert. / Kompatibel mit ISCR Wendeplatten.

Sipariş Örneği/Ordering Example/Bestellbeispiel

1 ad./pcs./stück ATUM 14XD3 SO.. 050204

Takma Uçlu Matkap Kullanım Kılavuzu : S 375 / User's Guide For U-Drills : P 375  
Bedienungsanleitung für Vollbohrer : S 375



Delme Derinliği  
Drilling Depth  
Bohrtiefe

= 4x Çap  
= 4x Diameter  
= 4x Durchmesser

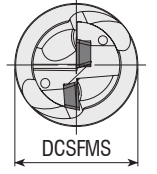
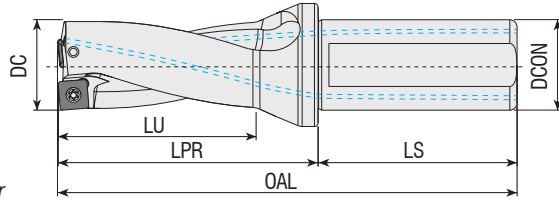

| Takım Kodu<br>Ordering Code<br>Bestell-Bezeichnung | Stok<br>Stock<br>Lager | Takım Ölçüleri (mm)<br>Dimension (mm)<br>Abmessung (mm) |      |        |     |     |     |    | Maks. Ofset (radyal)<br>Max. Offset (radial)<br>Max. Versatz (radial) | Kesici Uç<br>Insert<br>Wendeschneidplatte | Yedek Parçaları / Spare Parts / Ersatzteile |  |        |
|--|------------------------|---|------|--------|-----|-----|-----|----|---|---|---|--|--------|
|  |                        | DC  | DCON | DCSFMS | OAL | LU  | LPR | LS |   |   | Sıkma Vidası<br>Screw<br>Schraube           | Tork Anahtar<br>Torx Key<br>Torx-Schlüssel |        |
| ATUM 14XD4 SO.. 050204                             | ●                      | 14  | 20   | 25     | 128 | 56  | 78  | 50 | 1.4   | 16.8                                      | SO.. 050204                                 | 3006-M2x4                                  | 82-T06 |
| ATUM 14.5XD4 SO.. 050204                           | ●                      | 14.5  | 20   | 25     | 128 | 56  | 78  | 50 | 1.3   | 17.1                                      |   |  |        |
| ATUM 15XD4 SO.. 050204                             | ●                      | 15  | 20   | 25     | 132 | 60  | 62  | 50 | 1.2   | 17.4                                      |   |  |        |
| ATUM 15.5XD4 SO.. 050204                           | ●                      | 15.5  | 20   | 25     | 132 | 60  | 82  | 50 | 1   | 17.5                                      |   |  |        |
| ATUM 17XD4 SO.. 050204                             | ●                      | 17  | 25   | 34     | 146 | 68  | 90  | 56 | 0.65  | 18.3                                      |   |  |        |
| ATUM 19XD4 SO.. 060304                             | ●                      | 19  | 25   | 34     | 154 | 76  | 98  | 56 | 0.9   | 20.8                                      | SO.. 060304                                 | 3007-M2.2x4.6                              | 82-T07 |
| ATUM 19.5XD4 SO.. 060304                           | ●                      | 19.5  | 25   | 34     | 154 | 76  | 98  | 56 | 0.75  | 21  |   |  |        |
| ATUM 20XD4 SO.. 060304                             | ●                      | 20  | 25   | 34     | 158 | 80  | 102 | 56 | 0.65  | 21.3                                      |   |  |        |
| ATUM 21XD4 SO.. 070305                             | ●                      | 21  | 25   | 34     | 162 | 84  | 106 | 56 | 1.75  | 24.5                                      | SO.. 070305                                 | 3008-M2.5x6                                | 82-T08 |
| ATUM 22XD4 SO.. 070305                             | ●                      | 22  | 25   | 34     | 166 | 88  | 110 | 56 | 1.5   | 25  |   |  |        |
| ATUM 22.5XD4 SO.. 070305                           | ●                      | 22.5  | 25   | 34     | 166 | 88  | 110 | 56 | 1.35  | 25.2                                      |   |  |        |
| ATUM 23XD4 SO.. 070305                             | ●                      | 23  | 25   | 34     | 170 | 92  | 114 | 56 | 1.25  | 25.5                                      |   |  |        |
| ATUM 24XD4 SO.. 070305                             | ●                      | 24  | 25   | 34     | 174 | 96  | 118 | 56 | 1   | 26  |   |  |        |
| ATUM 25XD4 SO.. 09T306                             | ●                      | 25  | 25   | 34     | 178 | 100 | 122 | 56 | 2.25  | 29.5                                      | SO.. 09T306                                 | 4010-M3x8                                  | 82-T10 |
| ATUM 27XD4 SO.. 09T306                             | ●                      | 27  | 25   | 34     | 186 | 108 | 130 | 56 | 1.75  | 30.5                                      |   |  |        |
| ATUM 28XD4 SO.. 09T306                             | ●                      | 28  | 25   | 34     | 190 | 112 | 134 | 56 | 1.5   | 31  |   |  |        |
| ATUM 29XD4 SO.. 09T306                             | ●                      | 29  | 25   | 34     | 194 | 116 | 138 | 56 | 1.25  | 31.5                                      |   |  |        |
| ATUM 30XD4 SO.. 09T306                             | ●                      | 30  | 32   | 44     | 207 | 120 | 147 | 60 | 1   | 32  |   |  |        |
| ATUM 31XD4 SO.. 09T306                             | ●                      | 31  | 32   | 44     | 211 | 124 | 151 | 60 | 0.75  | 32.5                                      | SO..120408                                  | 4015-M4X11                                 | 80-T15 |
| ATUM 33XD4 SO.. 09T306                             | ●                      | 33  | 32   | 44     | 219 | 132 | 159 | 60 | 0.5   | 34  |   |  |        |
| ATUM 34XD4 SO.. 09T306                             | ●                      | 34  | 32   | 44     | 223 | 136 | 163 | 60 | 0.25  | 34.5                                      |   |  |        |
| ATUM 35XD4 SO.. 120408                             | ●                      | 35  | 32   | 44     | 227 | 140 | 167 | 60 | 2.75  | 40.5                                      |   |  |        |

R: Sağ / Right / Rechts/ L: Sol / Left / Links

● Stokta / In Stock / Auf Lager ○ Stokta Yok / Non Stock Item / Kein Lagerartikel, Lieferzeit auf Anfrage  
ISCR Ucuna Uygunudur. / Compatible with ISCR Insert. / Kompatibel mit ISCR Wendeplatten.

Sipariş Örneği/Ordering Example/Bestellbeispiel

1 ad./pcs./stück ATUM 14XD4 SO.. 050204

Takma Uçlu Matkap Kullanım Kılavuzu : S 375 / User's Guide For U-Drills : P 375  
Bedienungsanleitung für Vollbohrer : S 375



Delme Derinliği  
Drilling Depth  
Bohrtiefe

= 2x Çap  
= 2x Diameter  
= 2x Durchmesser

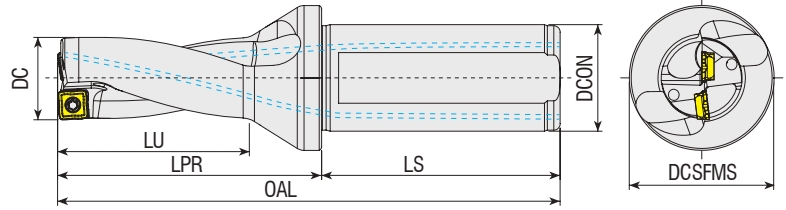

**Takım Kodu**  
**Ordering Code**  
**Bestell-Bezeichnung**

| Stok<br>Stock<br>Lager | Takım Ölçüleri (mm)<br>Dimension (mm)<br>Abmessung (mm) |      |        |     |     |     |    |           | Maks. Ofset (radyal)<br>Max. Offset (radial)<br>Max. Versatz (radial) |                                   | Kesici Uç<br>Insert<br>Wendeschneldplatte | Yedek Parçaları / Spare Parts / Ersatzteile |        |
|------------------------|---|------|--------|-----|-----|-----|----|-----------|---|-----------------------------------|---|---|--------|
|                        | DC  | DCON | DCSFMS | OAL | LU  | LPR | LS | $X_{max}$ | $DC_{max}$  | Sıkma Vidası<br>Screw<br>Schraube |   | Tork Anahtar<br>Torx Key<br>Torx-Schlüssel  |        |
| ATUM 14XD2 SO.. 052704 | ●   | 14   | 20     | 25  | 100 | 28  | 50 | 50        | 0.60  | 15.20                             | SOMX 052704                               | 3006-M2x4.7                                 | 82-T08 |
| ATUM 15XD2 SO.. 052704 | ●   | 15   | 20     | 25  | 102 | 30  | 52 | 50        | 0.35  | 15.70                             |   |   |        |
| ATUM 16XD2 SO.. 052704 | ●   | 16   | 25     | 34  | 110 | 32  | 54 | 56        | 0.25  | 16.50                             |   |   |        |
| ATUM 17XD2 SO.. 063005 | ●   | 17   | 25     | 34  | 112 | 34  | 56 | 56        | 0.50  | 18.00                             | SOMX 063005                               | 3008-M2.5X6                                 | 82-T10 |
| ATUM 18XD2 SO.. 063005 | ●   | 18   | 25     | 34  | 114 | 36  | 58 | 56        | 0.40  | 18.80                             |   |   |        |
| ATUM 19XD2 SO.. 063005 | ●   | 19   | 25     | 34  | 116 | 38  | 60 | 56        | 0.30  | 19.60                             |   |   |        |
| ATUM 20XD2 SO.. 073505 | ●   | 20   | 25     | 34  | 118 | 40  | 62 | 56        | 0.60  | 21.20                             | SOMX 073505                               | 4010-M3X6                                   | 82-T10 |
| ATUM 21XD2 SO.. 073505 | ●   | 21   | 25     | 34  | 120 | 42  | 64 | 56        | 0.50  | 22.00                             |   |   |        |
| ATUM 22XD2 SO.. 073505 | ●   | 22   | 25     | 34  | 122 | 44  | 66 | 56        | 0.40  | 22.80                             |   |   |        |
| ATUM 23XD2 SO.. 084005 | ●   | 23   | 25     | 34  | 124 | 46  | 68 | 56        | 0.80  | 24.60                             | SOMX 084005                               | 3010-M3.5X7                                 | 82-T15 |
| ATUM 24XD2 SO.. 084005 | ●   | 24   | 25     | 34  | 126 | 48  | 70 | 56        | 0.70  | 25.40                             |   |   |        |
| ATUM 25XD2 SO.. 084005 | ●   | 25   | 25     | 34  | 128 | 50  | 72 | 56        | 0.60  | 26.20                             |   |   |        |
| ATUM 26XD2 SO.. 084005 | ●   | 26   | 25     | 34  | 130 | 52  | 74 | 56        | 0.50  | 27.00                             | SOMX 094506                               | 4015-M4X8                                   | 80-T15 |
| ATUM 28XD2 SO.. 094506 | ●   | 28   | 25     | 34  | 134 | 56  | 78 | 56        | 0.85  | 29.70                             |   |   |        |
| ATUM 30XD2 SO.. 094506 | ●   | 30   | 32     | 44  | 147 | 60  | 87 | 60        | 0.65  | 31.30                             |   |   |        |

R: Sağ / Right / Rechts/ L: Sol / Left / Links

● Stokta / In Stock / Auf Lager ○ Stokta Yok / Non Stock Item / Kein Lagerartikel, Lieferzeit auf Anfrage  
MTSBH Ucuna Uygunudur. / Compatible with MTSBH Insert. / Kompatibel mit MTSBH.

Sipariş Örneği/Ordering Example/Bestellbeispiel

1 ad./pcs./шт. ATUM 14XD2 SO.. 052704

Takma Uçlu Matkap Kullanım Kılavuzu : S 375 / User's Guide For U-Drills : P 375

Bedienungsanleitung für Vollbohrer : S 375





Delme Derinliği  
Drilling Depth  
Bohrtiefe

= 3x Çap  
= 3x Diameter  
= 3x Durchmesser

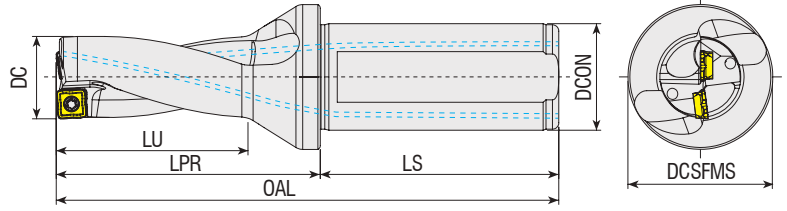

| Takım Kodu<br>Ordering Code<br>Bestell-Bezeichnung | Stok<br>Stock<br>Lager | Takım Ölçüleri (mm)<br>Dimension (mm)<br>Abmessung (mm) |      |        |     |      |     |    | Maks. Ofset (radyal)<br>Max. Offset (radial)<br>Max. Versatz (radial) |                   | Kesici Uç<br>Insert<br>Wendeschneidplatte | Yedek Parçaları / Spare Parts / Ersatzteile |  |
|--|------------------------|---|------|--------|-----|------|-----|----|---|-------------------|---|---|--|
|  |                        | DC  | DCON | DCSFMS | OAL | LU   | LPR | LS | X <sub>max</sub>  | DC <sub>max</sub> |   | Sıkma Vidası<br>Screw<br>Schraube           | Tork Anahtar<br>Torx Key<br>Torx-Schlüssel |
| ATUM 14XD3 SO.. 052704                             | ●                      | 14  | 20   | 25     | 114 | 42   | 64  | 50 | 0.60  | 15.2              | SOMX 052704                               | 3006-M2x4.7                                 | 82-T08                                     |
| ATUM 14.5XD3 SO.. 052704                           | ●                      | 14.5  | 20   | 25     | 114 | 43.5 | 64  | 50 | 0.50  | 15.5              |   |   |  |
| ATUM 15XD3 SO.. 052704                             | ●                      | 15  | 20   | 25     | 117 | 45   | 67  | 50 | 0.35  | 15.7              |   |   |  |
| ATUM 15.5XD3 SO.. 052704                           | ●                      | 16.5  | 25   | 34     | 126 | 49.5 | 70  | 56 | 0.25  | 17.0              |   |   |  |
| ATUM 16XD3 SO.. 052704                             | ●                      | 16  | 25   | 34     | 126 | 48   | 70  | 56 | 0.25  | 16.5              |   |   |  |
| ATUM 16.5XD3 SO.. 052704                           | ●                      | 16.5  | 25   | 34     | 126 | 49.5 | 70  | 56 | 0.25  | 17.0              |   |   |  |
| ATUM 17XD3 SO.. 063005                             | ●                      | 17  | 25   | 34     | 129 | 51   | 73  | 56 | 0.50  | 18.0              | SOMX 063005                               | 3008-M2.5X6                                 | 82-T08                                     |
| ATUM 17.5XD3 SO.. 063005                           | ●                      | 17.5  | 25   | 34     | 129 | 52.5 | 73  | 56 | 0.45  | 18.4              |   |   |  |
| ATUM 18XD3 SO.. 063005                             | ●                      | 18  | 25   | 34     | 132 | 54   | 76  | 56 | 0.40  | 18.8              |   |   |  |
| ATUM 18.5XD3 SO.. 063005                           | ●                      | 18.5  | 25   | 34     | 132 | 55.5 | 76  | 56 | 0.35  | 19.2              |   |   |  |
| ATUM 19XD3 SO.. 063005                             | ●                      | 19  | 25   | 34     | 135 | 57   | 79  | 56 | 0.30  | 19.6              |   |   |  |
| ATUM 19.5XD3 SO.. 063005                           | ●                      | 19.5  | 25   | 34     | 135 | 58.5 | 79  | 56 | 0.25  | 20.0              |   |   |  |
| ATUM 20XD3 SO.. 073505                             | ●                      | 20  | 25   | 34     | 138 | 60   | 82  | 56 | 0.60  | 21.2              | SOMX 073505                               | 4010-M3X6                                   | 82-T10                                     |
| ATUM 20.5XD3 SO.. 073505                           | ●                      | 20.5  | 25   | 34     | 138 | 61.5 | 82  | 56 | 0.55  | 21.6              |   |   |  |
| ATUM 21XD3 SO.. 073505                             | ●                      | 21  | 25   | 34     | 141 | 63   | 85  | 56 | 0.50  | 22.0              |   |   |  |
| ATUM 21.5XD3 SO.. 073505                           | ●                      | 21.5  | 25   | 34     | 141 | 64.5 | 85  | 56 | 0.45  | 22.4              |   |   |  |
| ATUM 22XD3 SO.. 073505                             | ●                      | 22  | 25   | 34     | 144 | 66   | 88  | 56 | 0.40  | 22.8              |   |   |  |
| ATUM 22.5XD3 SO.. 073505                           | ●                      | 22.5  | 25   | 34     | 144 | 67.5 | 88  | 56 | 0.35  | 23.2              |   |   |  |
| ATUM 23XD3 SO.. 084005                             | ●                      | 23  | 25   | 34     | 147 | 69   | 91  | 56 | 0.80  | 24.6              | SOMX 084005                               | 3010-M3.5X7                                 | 82-T10                                     |
| ATUM 23.5XD3 SO.. 084005                           | ●                      | 23.5  | 25   | 34     | 147 | 70.5 | 91  | 56 | 0.75  | 25.0              |   |   |  |
| ATUM 24XD3 SO.. 084005                             | ●                      | 24  | 25   | 34     | 150 | 72   | 94  | 56 | 0.70  | 25.4              |   |   |  |
| ATUM 24.5XD3 SO.. 084005                           | ●                      | 24.5  | 25   | 34     | 150 | 73.5 | 94  | 56 | 0.65  | 25.8              |   |   |  |
| ATUM 25XD3 SO.. 084005                             | ●                      | 25  | 25   | 34     | 153 | 75   | 97  | 56 | 0.60  | 26.2              |   |   |  |
| ATUM 26XD3 SO.. 084005                             | ●                      | 26  | 25   | 34     | 156 | 78   | 100 | 56 | 0.50  | 27                |   |   |  |
| ATUM 27XD3 SO.. 084005                             | ●                      | 27  | 25   | 34     | 159 | 81   | 103 | 56 | 0.45  | 27.9              | SOMX 094506                               | 4015-M4X8                                   | 80-T15                                     |
| ATUM 28XD3 SO.. 094506                             | ●                      | 28  | 25   | 34     | 162 | 84   | 106 | 56 | 0.85  | 29.7              |   |   |  |
| ATUM 29XD3 SO.. 094506                             | ●                      | 29  | 25   | 34     | 165 | 87   | 109 | 56 | 0.75  | 30.5              |   |   |  |
| ATUM 30XD3 SO.. 094506                             | ●                      | 30  | 32   | 44     | 177 | 90   | 117 | 60 | 0.65  | 31.3              |   |   |  |
| ATUM 32XD3 SO.. 094506                             | ●                      | 32  | 32   | 44     | 183 | 96   | 123 | 60 | 0.45  | 32.9              |   |   |  |

R: Sağ / Right / Rechts/ L: Sol / Left / Links

● Stokta / In Stock / Auf Lager ○ Stokta Yok / Non Stock Item / Kein Lagerartikel, Lieferzeit auf Anfrage  
MTSBH Ucuna Uygundur. / Compatible with MTSBH Insert. / Kompatibel mit MTSBH.

Sipariş Örneği/Ordering Example/Bestellbeispiel  
1 ad./pcs./stück ATUM 14.5XD3 SO.. 052704

Takma Uçlu Matkap Kullanım Kılavuzu : S 375 / User's Guide For U-Drills : P 375  
Bedienungsanleitung für Vollbohrer : S 375





Delme Derinliği  
Drilling Depth  
Bohrtiefe

= 4x Çap  
= 4x Diameter  
= 4x Durchmesser

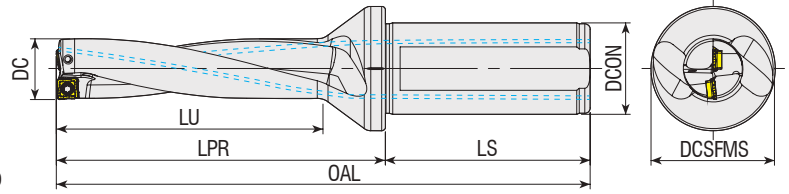

**Takım Kodu**  
**Ordering Code**  
**Bestell-Bezeichnung**

| Stok<br>Stock<br>Lager | Takım Ölçüleri (mm)<br>Dimension (mm)<br>Abmessung (mm) |      |        |     |     |     |     |                  | Maks. Ofset (radial)<br>Max. Offset (radial)<br>Max. Versatz (radial) |                                   | Kesici Uç<br>Insert<br>Wendeschneidplatte | Yedek Parçaları / Spare Parts / Ersatzteile |        |  |
|------------------------|---|------|--------|-----|-----|-----|-----|------------------|---|-----------------------------------|---|---|--------|--|
|                        | DC  | DCON | DCSFMS | OAL | LU  | LPR | LS  | X <sub>max</sub> | DC <sub>max</sub>   | Sıkma Vidası<br>Screw<br>Schraube |   | Tork Anahtar<br>Torx Key<br>Torx-Schlüssel  |        |  |
| ATUM 14XD4 SO.. 052704 | ●   | 14   | 20     | 25  | 128 | 56  | 78  | 50               | 0.60  | 15.2                              | SOMX 052704                               | 3006-M2x4.7                                 | 82-T08 |  |
| ATUM 15XD4 SO.. 052704 | ●   | 15   | 20     | 25  | 132 | 60  | 82  | 50               | 0.35  | 15.7                              |   |   |        |  |
| ATUM 16XD4 SO.. 052704 | ●   | 16   | 25     | 34  | 142 | 64  | 86  | 56               | 0.25  | 16.5                              | SOMX 063005                               | 3008-M2.5X6                                 | 82-T08 |  |
| ATUM 17XD4 SO.. 063005 | ●   | 17   | 25     | 34  | 146 | 68  | 90  | 56               | 0.50  | 18.0                              |   |   |        |  |
| ATUM 18XD4 SO.. 063005 | ●   | 18   | 25     | 34  | 150 | 72  | 94  | 56               | 0.40  | 18.8                              | SOMX 073505                               | 4010-M3X6                                   | 82-T10 |  |
| ATUM 19XD4 SO.. 063005 | ●   | 19   | 25     | 34  | 154 | 76  | 98  | 56               | 0.30  | 19.6                              |   |   |        |  |
| ATUM 20XD4 SO.. 073505 | ●   | 20   | 25     | 34  | 158 | 80  | 102 | 56               | 0.60  | 21.2                              | SOMX 084005                               | 3010-M3.5X7                                 | 80-T15 |  |
| ATUM 21XD4 SO.. 073505 | ●   | 21   | 25     | 34  | 162 | 84  | 106 | 56               | 0.50  | 22.0                              |   |   |        |  |
| ATUM 22XD4 SO.. 073505 | ●   | 22   | 25     | 34  | 166 | 88  | 110 | 56               | 0.40  | 22.8                              | SOMX 094506                               | 4015-M4X8                                   | 80-T15 |  |
| ATUM 23XD4 SO.. 084005 | ●   | 23   | 25     | 34  | 170 | 92  | 114 | 56               | 0.80  | 24.6                              |   |   |        |  |
| ATUM 24XD4 SO.. 084005 | ●   | 24   | 25     | 34  | 174 | 96  | 118 | 56               | 0.70  | 25.4                              | SOMX 094506                               | 4015-M4X8                                   | 80-T15 |  |
| ATUM 25XD4 SO.. 084005 | ●   | 25   | 25     | 34  | 178 | 100 | 122 | 56               | 0.60  | 26.2                              |   |   |        |  |
| ATUM 26XD4 SO.. 084005 | ●   | 26   | 25     | 34  | 182 | 104 | 126 | 56               | 0.50  | 27.0                              | SOMX 094506                               | 4015-M4X8                                   | 80-T15 |  |
| ATUM 28XD4 SO.. 094506 | ●   | 28   | 25     | 34  | 190 | 112 | 134 | 56               | 0.85  | 29.7                              |   |   |        |  |
| ATUM 30XD4 SO.. 094506 | ●   | 30   | 32     | 44  | 207 | 120 | 147 | 60               | 0.65  | 31.3                              | SOMX 094506                               | 4015-M4X8                                   | 80-T15 |  |
| ATUM 30XD4 SO.. 094506 | ●   | 30   | 32     | 44  | 207 | 120 | 147 | 60               | 0.65  | 31.3                              |   |   |        |  |

R: Sağ / Right / Rechts/ L: Sol / Left / Links  
● Stokta / In Stock / Auf Lager ○ Stokta Yok / Non Stock Item / Kein Lagerartikel, Lieferzeit auf Anfrage  
MTSBH Ucuna Uygunudur. / Compatible with MTSBH Insert. / Kompatibel mit MTSBH.

Sipariş Örneği/Ordering Example/Bestellbeispiel  
1 ad./pcs./stück ATUM 14XD4 SO.. 052704

Takma Uçlu Matkap Kullanım Kılavuzu : S 375 / User's Guide For U-Drills : P 375  
Bedienungsanleitung für Vollbohrer : S 375





Delme Derinliği  
Drilling Depth  
Bohrtiefe

= 2x Çap  
= 2x Diameter  
= 2x Durchmesser

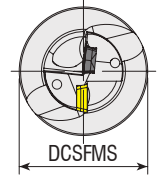
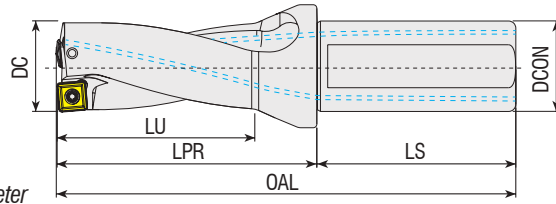

Takım Kodu  
Ordering Code  
Bestell-Bezeichnung

| Stok<br>Stock<br>Lager | Takım Ölçüleri (mm)<br>Dimension (mm)<br>Abmessung (mm) |      |        |     |    |     |    |           | Maks. Ofset (radyal)<br>Max. Offset (radial)<br>Max. Versatz (radial) |                                   | Kesici Uç<br>Insert<br>Wendeschneidplatte | Yedek Parçaları / Spare Parts / Ersatzteile |  |
|------------------------|---|------|--------|-----|----|-----|----|-----------|---|-----------------------------------|---|---|--|
|                        | DC  | DCON | DCSFMS | OAL | LU | LPR | LS | $X_{max}$ | $DC_{max}$  | Sıkma Vidası<br>Screw<br>Schraube |   | Tork Anahtar<br>Torx Key<br>Torx-Schlüssel  |  |
| ●                      | 14  | 20   | 25     | 100 | 28 | 50  | 50 | 0.25      | 14.5  | SPMT 050204-XOMT 050204           | 3006-M2x4                                 | 82-T06                                      |  |
| ●                      | 18  | 25   | 34     | 114 | 36 | 58  | 56 | 0.5       | 19  | SPMT 060205-XOMT 060204           | 3007-M2.2x4.6                             | 82-T07                                      |  |
| ●                      | 20  | 25   | 34     | 118 | 40 | 62  | 56 | 0.3       | 20.6  | SPMT 07T208<br>XOMT 07T205        | 3008-M2.5x6                               | 82-T08                                      |  |
| ●                      | 22  | 25   | 34     | 122 | 44 | 66  | 56 | 0.3       | 22.6  | SPMT 090308<br>XOMT 090305        | 3008-M3x7                                 |   |  |
| ●                      | 24  | 25   | 34     | 126 | 48 | 70  | 56 | 0.3       | 24.6  |                                   |   |   |  |
| ●                      | 25  | 25   | 34     | 128 | 50 | 72  | 56 | 0.3       | 25.6  |                                   |   |   |  |
| ●                      | 26  | 25   | 34     | 130 | 52 | 74  | 56 | 0.3       | 26.6  |                                   |   |   |  |
| ●                      | 28  | 25   | 34     | 134 | 56 | 78  | 56 | 0.3       | 28.6  |                                   |   |   |  |
| ●                      | 30  | 25   | 34     | 147 | 60 | 87  | 60 | 0.35      | 30.7  | SPMT 11T308<br>XOMT 11T306        | 4015-M3.5x9                               | 80-T15                                      |  |
| ●                      | 32  | 32   | 44     | 151 | 64 | 91  | 60 | 0.35      | 32.7  |                                   |   |   |  |
| ●                      | 34  | 32   | 44     | 155 | 68 | 95  | 60 | 0.35      | 34.7  |                                   |   |   |  |
| ●                      | 36  | 32   | 44     | 159 | 72 | 99  | 60 | 0.35      | 36.7  | SPMT 130410<br>XOMT 130406        | 4015-M4x11                                |   |  |
| ●                      | 37  | 32   | 44     | 161 | 74 | 101 | 60 | 0.35      | 37.7  |                                   |   |   |  |
| ●                      | 38  | 32   | 44     | 163 | 76 | 103 | 60 | 0.35      | 38.7  |                                   |   |   |  |

KRLY Ucuna Uygunur. / Compatible with KRLY Insert. / Kompatibel mit KRYL

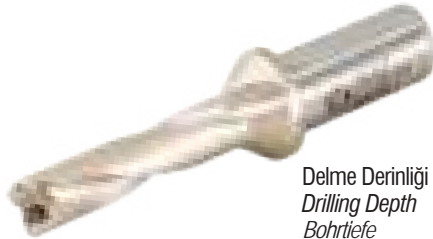

Delme Derinliği  
Drilling Depth  
Bohrtiefe

= 4x Çap  
= 4x Diameter  
= 4x Durchmesser

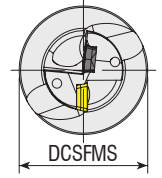
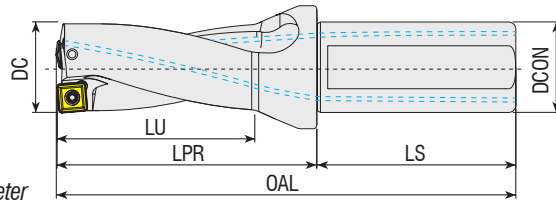

Takım Kodu  
Ordering Code  
Bestell-Bezeichnung

| Stok<br>Stock<br>Lager | Takım Ölçüleri (mm)<br>Dimension (mm)<br>Abmessung (mm) |      |        |     |     |     |    |           | Maks. Ofset (radyal)<br>Max. Offset (radial)<br>Max. Versatz (radial) |                                   | Kesici Uç<br>Insert<br>Wendeschneidplatte | Yedek Parçaları / Spare Parts / Ersatzteile |  |
|------------------------|---|------|--------|-----|-----|-----|----|-----------|---|-----------------------------------|---|---|--|
|                        | DC  | DCON | DCSFMS | OAL | LU  | LPR | LS | $X_{max}$ | $DC_{max}$  | Sıkma Vidası<br>Screw<br>Schraube |   | Tork Anahtar<br>Torx Key<br>Torx-Schlüssel  |  |
| ●                      | 14  | 20   | 25     | 128 | 56  | 78  | 50 | 0.25      | 14.5  | SPMT 050204<br>XOMT 050204        | 3006-M2x4                                 | 82-T06                                      |  |
| ●                      | 14.5  | 20   | 25     | 128 | 56  | 78  | 50 | 0.25      | 15  |                                   |   |   |  |
| ●                      | 15  | 20   | 25     | 132 | 60  | 82  | 50 | 0.25      | 15.5  |                                   |   |   |  |
| ●                      | 15.5  | 20   | 25     | 132 | 60  | 82  | 50 | 0.25      | 16  |                                   |   |   |  |
| ●                      | 16  | 25   | 34     | 142 | 64  | 86  | 56 | 0.25      | 16.5  |                                   |   |   |  |
| ●                      | 17  | 25   | 34     | 146 | 68  | 90  | 56 | 0.5       | 18  | SPMT 060205<br>XOMT 060204        | 3007-M2.2x4.6                             | 82-T07                                      |  |
| ●                      | 17.5  | 25   | 34     | 146 | 68  | 90  | 56 | 0.5       | 18.5  |                                   |   |   |  |
| ●                      | 18  | 25   | 34     | 150 | 72  | 94  | 56 | 0.5       | 19  |                                   |   |   |  |
| ●                      | 18.5  | 25   | 34     | 150 | 72  | 94  | 56 | 0.5       | 19.5  |                                   |   |   |  |
| ●                      | 19  | 25   | 34     | 154 | 76  | 98  | 56 | 0.5       | 20  |                                   |   |   |  |
| ●                      | 20  | 25   | 34     | 158 | 80  | 102 | 56 | 0.3       | 20.6  | SPMT 07T208<br>XOMT 07T205        | 3008-M2.5x6                               | 82-T08                                      |  |
| ●                      | 21  | 25   | 34     | 162 | 84  | 106 | 56 | 0.3       | 21.6  |                                   |   |   |  |
| ●                      | 22  | 25   | 34     | 166 | 88  | 110 | 56 | 0.3       | 22.6  |                                   |   |   |  |
| ●                      | 24  | 25   | 34     | 174 | 96  | 118 | 56 | 0.3       | 24.6  | SPMT 090308<br>XOMT 090305        | 3008-M3x7                                 |   |  |
| ●                      | 25  | 25   | 34     | 178 | 100 | 122 | 56 | 0.3       | 25.6  |                                   |   |   |  |

R: Sağ / Right / Rechts/ L: Sol / Left / Links

● Stokta / In Stock / Auf Lager ○ Stokta Yok / Non Stock Item / Kein Lagerartikel, Lieferzeit auf Anfrage

KRLY Ucuna Uygunur. / Compatible with KRLY Insert. / Kompatibel mit KRYL

Sipariş Örneği/Ordering Example/Bestellbeispiel

1 ad./pcs./stück ATUM 14XD2 KDR 0502..

Takma Uçlu Matkap Kullanım Kılavuzu : S 375 / User's Guide For U-Drills : P 375

Bedienungsanleitung für Vollbohrer : S 375



Delme Derinliği  
Drilling Depth  
Bohrtiefe

= 3x Çap  
= 3x Diameter  
= 3x Durchmesser

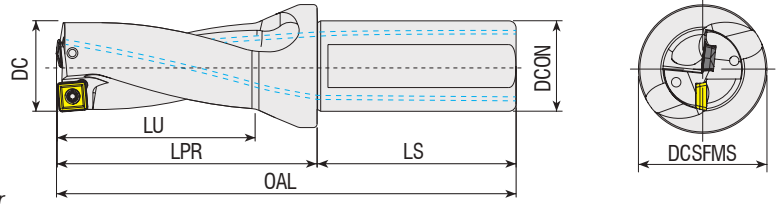

**Takım Kodu**  
**Ordering Code**  
**Bestell-Bezeichnung**

Stok  
Stock  
Lager

Takım Ölçüleri (mm)  
Dimension (mm)  
Abmessung (mm)

Maks. Ofset (radial)  
Max. Offset (radial)  
Max. Versatz (radial)

Kesici Uç  
Insert  
Wendeschneidplatte

Yedek Parçaları / Spare Parts / Ersatzteile

Sıkma Vidası  
Screw  
Schraube

Tork Anahtar  
Torx Key  
Torx-Schlüssel

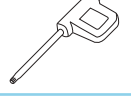

| ATUM               | DC | DCON | DCSFMS | OAL | LU  | LPR | LS  | X <sub>max</sub> | DC <sub>max</sub> | SPMT | XOMT        | Sıkma Vidası  | Tork Anahtar |
|--------------------|----|------|--------|-----|-----|-----|-----|------------------|-------------------|------|-------------|---------------|--------------|
| 12.5XD3 KDR 0402.. | ●  | 12.5 | 20     | 25  | 108 | 36  | 58  | 50               | 0.2               | 12.9 | SPMT 040204 |               |              |
| 13XD3 KDR 0402..   | ●  | 13   | 20     | 25  | 111 | 39  | 61  | 50               | 0.2               | 13.4 | XOMT 040204 |               |              |
| 14XD3 KDR 0502..   | ●  | 14   | 20     | 25  | 114 | 42  | 64  | 50               | 0.25              | 14.5 |             |               |              |
| 14.5XD3 KDR 0502.. | ●  | 14.5 | 20     | 25  | 114 | 42  | 64  | 50               | 0.25              | 15   |             | 3006-M2x4     | 82-T06       |
| 15XD3 KDR 0502..   | ●  | 15   | 20     | 25  | 117 | 45  | 67  | 50               | 0.25              | 15.5 |             |               |              |
| 15.5XD3 KDR 0502.. | ●  | 15.5 | 20     | 25  | 117 | 45  | 67  | 50               | 0.25              | 16   |             |               |              |
| 16XD3 KDR 0502..   | ●  | 16   | 25     | 34  | 126 | 48  | 70  | 56               | 0.25              | 16.5 |             |               |              |
| 16.5XD3 KDR 0602.. | ●  | 16.5 | 25     | 34  | 126 | 48  | 70  | 56               | 0.5               | 17.5 |             |               |              |
| 17XD3 KDR 0602..   | ●  | 17   | 25     | 34  | 129 | 51  | 73  | 56               | 0.5               | 18   |             |               |              |
| 17.5XD3 KDR 0602.. | ●  | 17.5 | 25     | 34  | 129 | 51  | 73  | 56               | 0.5               | 18.5 |             |               |              |
| 18XD3 KDR 0602..   | ●  | 18   | 25     | 34  | 132 | 54  | 76  | 56               | 0.5               | 19   |             | 3007-M2.2x4.6 | 82-T07       |
| 18.5XD3 KDR 0602.. | ●  | 18.5 | 25     | 34  | 132 | 54  | 76  | 56               | 0.5               | 19.5 |             |               |              |
| 19XD3 KDR 0602..   | ●  | 19   | 25     | 34  | 135 | 57  | 79  | 56               | 0.5               | 20   |             |               |              |
| 19.5XD3 KDR 0602.. | ●  | 19.5 | 25     | 34  | 135 | 57  | 79  | 56               | 0.5               | 20.5 |             |               |              |
| 20XD3 KDR 07T2..   | ●  | 20   | 25     | 34  | 138 | 60  | 82  | 56               | 0.3               | 20.6 |             |               |              |
| 20.5XD3 KDR 07T2.. | ●  | 20.5 | 25     | 34  | 138 | 60  | 82  | 56               | 0.3               | 21.1 |             |               |              |
| 21XD3 KDR 07T2..   | ●  | 21   | 25     | 34  | 141 | 63  | 85  | 56               | 0.3               | 21.6 |             |               |              |
| 22XD3 KDR 07T2..   | ●  | 22   | 25     | 34  | 144 | 66  | 88  | 56               | 0.3               | 22.6 |             | 3008-M2.5x6   |              |
| 22.5XD3 KDR 07T2.. | ●  | 22.5 | 25     | 34  | 144 | 68  | 88  | 56               | 0.3               | 23.1 |             |               |              |
| 23XD3 KDR 07T2..   | ●  | 23   | 25     | 34  | 147 | 69  | 91  | 56               | 0.3               | 23.6 |             |               |              |
| 23.5XD3 KDR 07T2.. | ●  | 23.5 | 25     | 34  | 147 | 69  | 91  | 56               | 0.3               | 24.1 |             |               | 82-T08       |
| 24XD3 KDR 0903..   | ●  | 24   | 25     | 34  | 150 | 72  | 94  | 56               | 0.3               | 24.6 |             |               |              |
| 24.5XD3 KDR 0903.. | ●  | 24.5 | 25     | 34  | 150 | 72  | 94  | 56               | 0.3               | 25.1 |             |               |              |
| 25XD3 KDR 0903..   | ●  | 25   | 25     | 34  | 153 | 75  | 97  | 56               | 0.3               | 25.6 |             |               |              |
| 26XD3 KDR 0903..   | ●  | 26   | 25     | 34  | 156 | 78  | 100 | 56               | 0.3               | 26.6 |             | 3008-M3x7     |              |
| 27XD3 KDR 0903..   | ●  | 27   | 25     | 34  | 159 | 81  | 103 | 56               | 0.3               | 27.6 |             |               |              |
| 28XD3 KDR 0903..   | ●  | 28   | 25     | 34  | 162 | 84  | 106 | 56               | 0.3               | 28.6 |             |               |              |
| 29XD3 KDR 0903..   | ●  | 29   | 25     | 34  | 165 | 87  | 109 | 56               | 0.3               | 29.6 |             |               |              |
| 30XD3 KDR 11T3..   | ●  | 30   | 32     | 44  | 177 | 90  | 117 | 60               | 0.35              | 30.7 |             |               |              |
| 32XD3 KDR 11T3..   | ●  | 32   | 32     | 44  | 183 | 96  | 123 | 60               | 0.35              | 32.7 |             |               |              |
| 33XD3 KDR 11T3..   | ●  | 33   | 32     | 44  | 186 | 99  | 126 | 60               | 0.35              | 33.7 |             | 4015-M3.5x9   |              |
| 34XD3 KDR 11T3..   | ●  | 34   | 32     | 44  | 189 | 102 | 129 | 60               | 0.35              | 34.7 |             |               |              |
| 35XD3 KDR 11T3..   | ●  | 35   | 32     | 44  | 192 | 105 | 132 | 60               | 0.35              | 35.7 |             |               | 80-T15       |
| 37XD3 KDR 1304..   | ●  | 37   | 32     | 44  | 198 | 111 | 138 | 60               | 0.35              | 37.7 |             |               |              |
| 38XD3 KDR 1304..   | ●  | 38   | 32     | 44  | 201 | 114 | 141 | 60               | 0.35              | 38.7 |             |               |              |
| 39XD3 KDR 1304..   | ●  | 39   | 32     | 44  | 204 | 117 | 144 | 60               | 0.35              | 39.7 |             |               |              |
| 40XD3 KDR 1304..   | ●  | 40   | 32     | 44  | 207 | 120 | 147 | 60               | 0.35              | 40.7 |             | 4015-M4x11    |              |

R: Sağ / Right / Rechts/ L: Sol / Left / Links

● Stokta / In Stock / Auf Lager ○ Stokta Yok / Non Stock Item / Kein Lagerartikel, Lieferzeit auf Anfrage  
KRLY Uçuna Uygun. / Compatible with KRLY Insert. / Kompatibel mit KRLY

Sipariş Örneği/Ordering Example/Bestellbeispiel  
1 ad./pcs./stück ATUM 12.5XD3 KDR 0402..

Takma Uçlu Matkap Kullanım Kılavuzu : S 375 / User's Guide For U-Drills : P 375  
Bedienungsanleitung für Vollbohrer : S 375



Delme Derinliği  
Drilling Depth  
Bohrtiefe  
= 2x Çap  
= 2x Diameter  
= 2x Durchmesser

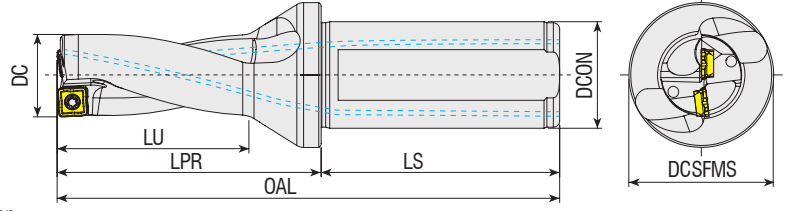

| Takım Kodu<br>Ordering Code<br>Bestell-Bezeichnung | Stok<br>Stock<br>Lager | Takım Ölçüleri (mm)<br>Dimension (mm)<br>Abmessung (mm) |      |        |     |    |     |    | Maks. Ofset (radyal)<br>Max. Offset (radial)<br>Max. Versatz (radial) |                   | Kesici Uç<br>Insert<br>Wendeschneidplatte | Yedek Parçaları / Spare Parts / Ersatzteile |  |  |
|--|------------------------|---|------|--------|-----|----|-----|----|---|-------------------|---|---|--|--|
|  |                        | DC  | DCON | DCSFMS | OAL | LU | LPR | LS | X <sub>max</sub>  | DC <sub>max</sub> |   | Sıkma Vidası<br>Screw<br>Schraube           | Tork Anahtar<br>Torx Key<br>Torx-Schlüssel |  |
| ATUM 14XD2 SOMT 050204                             | ●                      | 14  | 20   | 25     | 100 | 28 | 50  | 50 | 0.5   | 15                | SOMT 050204                               | 3006-M2x4                                   | 82-T06                                     |  |
| ATUM 16XD2 SOMT 050204                             | ●                      | 16  | 25   | 34     | 110 | 32 | 54  | 56 | 0.3   | 16.6              |   |   |  |  |
| ATUM 17XD2 SOMT 060204                             | ●                      | 17  | 25   | 34     | 112 | 34 | 56  | 56 | 0.5   | 18                | SOMT 060204                               | 3007-M2.2x4.6                               | 82-T07                                     |  |
| ATUM 18XD2 SOMT 060204                             | ●                      | 18  | 25   | 34     | 114 | 36 | 58  | 56 | 0.4   | 18.8              |   |   |  |  |
| ATUM 20XD2 SOMT 070306                             | ●                      | 20  | 25   | 34     | 118 | 40 | 62  | 56 | 0.5   | 21                | SOMT 070306                               |   |  |  |
| ATUM 22XD2 SOMT 070306                             | ●                      | 22  | 25   | 34     | 122 | 44 | 66  | 56 | 0.3   | 22.6              |   |   |  |  |
| ATUM 23XD2 SOMT 08T306                             | ●                      | 23  | 25   | 34     | 124 | 46 | 68  | 56 | 0.5   | 24                | SOMT 08T306                               | 3008-M2.5x6                                 | 82-T08                                     |  |
| ATUM 24XD2 SOMT 08T306                             | ●                      | 24  | 25   | 34     | 126 | 48 | 70  | 56 | 0.5   | 25                |   |   |  |  |
| ATUM 25XD2 SOMT 08T306                             | ●                      | 25  | 25   | 34     | 128 | 50 | 72  | 56 | 0.4   | 25.8              | SOMT 08T306                               |   |  |  |
| ATUM 26XD2 SOMT 08T306                             | ●                      | 26  | 25   | 34     | 130 | 52 | 74  | 56 | 0.3   | 26.6              |   |   |  |  |
| ATUM 27XD2 SOMT 09T308                             | ●                      | 27  | 25   | 34     | 132 | 54 | 76  | 56 | 0.5   | 28                | SOMT 09T308                               |   |  |  |
| ATUM 28XD2 SOMT 09T308                             | ●                      | 28  | 25   | 34     | 134 | 56 | 78  | 56 | 0.5   | 29                |   |   |  |  |
| ATUM 29XD2 SOMT 09T308                             | ●                      | 29  | 25   | 34     | 136 | 58 | 80  | 56 | 0.5   | 30                | SOMT 09T308                               | 4015-M3.5x9                                 | 80-T15                                     |  |
| ATUM 30XD2 SOMT 09T308                             | ●                      | 30  | 32   | 44     | 147 | 60 | 87  | 60 | 0.5   | 31                |   |   |  |  |
| ATUM 32XD2 SOMT 11T308                             | ●                      | 32  | 32   | 44     | 151 | 64 | 91  | 60 | 0.5   | 33                | SOMT 11T308                               |   |  |  |
| ATUM 33XD2 SOMT 11T308                             | ●                      | 33  | 32   | 44     | 153 | 66 | 93  | 60 | 0.5   | 34                |   |   |  |  |
| ATUM 34XD2 SOMT 11T308                             | ●                      | 34  | 32   | 44     | 155 | 68 | 95  | 60 | 0.5   | 35                | SOMT 11T308                               |   |  |  |
| ATUM 35XD2 SOMT 11T308                             | ●                      | 35  | 32   | 44     | 157 | 70 | 97  | 60 | 0.5   | 36                |   |   |  |  |
| ATUM 37XD2 SOMT 130408                             | ●                      | 37  | 32   | 44     | 161 | 74 | 101 | 60 | 0.5   | 38                | SOMT 130408                               | 4015-M4x11                                  |  |  |
| ATUM 38XD2 SOMT 130408                             | ●                      | 38  | 32   | 44     | 163 | 76 | 103 | 60 | 0.5   | 39                |   |   |  |  |
| ATUM 40XD2 SOMT 130408                             | ●                      | 40  | 32   | 44     | 167 | 80 | 107 | 60 | 0.5   | 41                | SOMT 130408                               |   |  |  |
| ATUM 45XD2 SOMT 150510                             | ●                      | 45  | 40   | 54     | 192 | 90 | 122 | 70 | 0.5   | 46                |   |   |  |  |
| ATUM 47XD2 SOMT 150510                             | ●                      | 47  | 40   | 54     | 196 | 94 | 126 | 70 | 0.5   | 48                | SOMT 150510                               | 1020-M5x11                                  | 80-T20                                     |  |

R: Sağ / Right / Rechts L: Sol / Left / Links

● Stokta / In Stock / Auf Lager ○ Stokta Yok / Non Stock Item / Kein Lagerartikel, Lieferzeit auf Anfrage  
TGTC Ucuna Uygunur. / Compatible with TGTC Insert. / Kompatibel mit TGTC Wendeplatten.

Sipariş Örneği/Ordering Example/Bestellbeispiel

1 ad./pcs./stück ATUM 14XD2 SOMT 050204

Takma Uçlu Matkap Kullanım Kılavuzu : S 375 / User's Guide For U-Drills : P 375  
Bedienungsanleitung für Vollbohrer : S 375



Delme Derinliği  
Drilling Depth  
Bohrtiefe

= 3x Çap  
= 3x Diameter  
= 3x Durchmesser

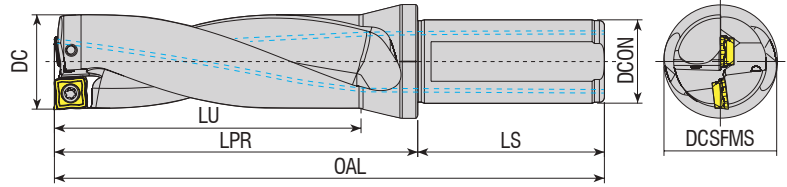

Takım Kodu  
Ordering Code  
Bestell-Bezeichnung

Stok  
Stock  
Lager

Takım Ölçüleri (mm)  
Dimension (mm)  
Abmessung (mm)

Maks. Ofset (radyal)  
Max. Offset (radial)  
Max. Versatz (radial)

Kesici Uç  
Insert  
Wendeschneidplatte

Yedek Parçaları / Spare Parts / Ersatzteile

Sıkma Vidası  
Screw  
Schraube

Tork Anahtar  
Torx Key  
Torx-Schlüssel

| Takım Kodu<br>Ordering Code<br>Bestell-Bezeichnung | Stok<br>Stock<br>Lager | Takım Ölçüleri (mm)<br>Dimension (mm)<br>Abmessung (mm) |      |        |     |     |     |    | Maks. Ofset (radyal)<br>Max. Offset (radial)<br>Max. Versatz (radial) |   | Kesici Uç<br>Insert<br>Wendeschneidplatte | Sıkma Vidası<br>Screw<br>Schraube | Tork Anahtar<br>Torx Key<br>Torx-Schlüssel |
|--|------------------------|---|------|--------|-----|-----|-----|----|---|---|---|-----------------------------------|--|
|  |                        | DC  | DCON | DCSFMS | OAL | LU  | LPR | LS | X <sub>max</sub><br>X <sub>max</sub> [mm]                             | DC <sub>max</sub><br>DC <sub>max</sub> [mm] |   |                                   |  |
| ATUM 14XD3 SOMT 050204                             | ●                      | 14  | 20   | 25     | 114 | 42  | 64  | 50 | 0.5   | 15  | SOMT 050204                               | 3006-M2x4                         | 82-T06                                     |
| ATUM 14.5XD3 SOMT 050204                           | ●                      | 14.5  | 20   | 25     | 114 | 42  | 64  | 50 | 0.4   | 15.3  |   |                                   |  |
| ATUM 15XD3 SOMT 050204                             | ●                      | 15  | 20   | 25     | 117 | 45  | 67  | 50 | 0.4   | 15.8  |   |                                   |  |
| ATUM 15.5XD3 SOMT 050204                           | ●                      | 15.5  | 20   | 25     | 117 | 45  | 67  | 50 | 0.3   | 16.1  |   |                                   |  |
| ATUM 16XD3 SOMT 050204                             | ●                      | 16  | 25   | 34     | 126 | 48  | 70  | 56 | 0.3   | 16.6  |   |                                   |  |
| ATUM 16.5XD3 SOMT 060204                           | ●                      | 16.5  | 25   | 34     | 126 | 48  | 70  | 56 | 0.5   | 17.5  |   |                                   |  |
| ATUM 17XD3 SOMT 060204                             | ●                      | 17  | 25   | 34     | 129 | 51  | 73  | 56 | 0.5   | 18  |   |                                   |  |
| ATUM 17.5XD3 SOMT 060204                           | ●                      | 17.5  | 25   | 34     | 129 | 51  | 73  | 56 | 0.4   | 18.3  |   |                                   |  |
| ATUM 18XD3 SOMT 060204                             | ●                      | 18  | 25   | 34     | 132 | 54  | 76  | 56 | 0.4   | 18.8  |   |                                   |  |
| ATUM 18.5XD3 SOMT 060204                           | ●                      | 18.5  | 25   | 34     | 132 | 54  | 76  | 56 | 0.3   | 19.1  |   |                                   |  |
| ATUM 19XD3 SOMT 060204                             | ●                      | 19  | 25   | 34     | 135 | 57  | 79  | 56 | 0.3   | 19.6  |   |                                   |  |
| ATUM 19.5XD3 SOMT 070306                           | ●                      | 19.5  | 25   | 34     | 135 | 57  | 79  | 56 | 0.5   | 20.5  |   |                                   |  |
| ATUM 20XD3 SOMT 070306                             | ●                      | 20  | 25   | 34     | 138 | 60  | 82  | 56 | 0.5   | 21  |   |                                   |  |
| ATUM 20.5XD3 SOMT 070306                           | ●                      | 20.5  | 25   | 34     | 138 | 60  | 82  | 56 | 0.4   | 21.3  |   |                                   |  |
| ATUM 21XD3 SOMT 070306                             | ●                      | 21  | 25   | 34     | 141 | 63  | 85  | 56 | 0.4   | 21.8  |   |                                   |  |
| ATUM 22XD3 SOMT 070306                             | ●                      | 22  | 25   | 34     | 144 | 66  | 88  | 56 | 0.3   | 22.6  |   |                                   |  |
| ATUM 22.5XD3 SOMT 08T306                           | ●                      | 22.5  | 25   | 34     | 144 | 66  | 88  | 56 | 0.5   | 23.5  |   |                                   |  |
| ATUM 23XD3 SOMT 08T306                             | ●                      | 23  | 25   | 34     | 147 | 69  | 91  | 56 | 0.5   | 24  |   |                                   |  |
| ATUM 23.5XD3 SOMT 08T306                           | ●                      | 23.5  | 25   | 34     | 147 | 69  | 91  | 56 | 0.5   | 24.5  |   |                                   |  |
| ATUM 24XD3 SOMT 08T306                             | ●                      | 24  | 25   | 34     | 150 | 72  | 94  | 56 | 0.5   | 25  |   |                                   |  |
| ATUM 24.5XD3 SOMT 08T306                           | ●                      | 24.5  | 25   | 34     | 150 | 72  | 94  | 56 | 0.4   | 25.3  |   |                                   |  |
| ATUM 25XD3 SOMT 08T306                             | ●                      | 25  | 25   | 34     | 153 | 75  | 97  | 56 | 0.4   | 25.8  |   |                                   |  |
| ATUM 26XD3 SOMT 08T306                             | ●                      | 26  | 25   | 34     | 156 | 78  | 100 | 56 | 0.3   | 26.6  |   |                                   |  |
| ATUM 27XD3 SOMT 09T308                             | ●                      | 27  | 25   | 34     | 159 | 81  | 103 | 56 | 0.5   | 28  |   |                                   |  |
| ATUM 27.5XD3 SOMT 09T308                           | ●                      | 27.5  | 25   | 34     | 159 | 81  | 103 | 56 | 0.5   | 27.5  |   |                                   |  |
| ATUM 28XD3 SOMT 09T308                             | ●                      | 28  | 25   | 34     | 162 | 84  | 106 | 56 | 0.5   | 29  |   |                                   |  |
| ATUM 29XD3 SOMT 09T308                             | ●                      | 29  | 25   | 34     | 165 | 87  | 109 | 56 | 0.5   | 30  |   |                                   |  |
| ATUM 30XD3 SOMT 09T308                             | ●                      | 30  | 32   | 44     | 177 | 90  | 117 | 60 | 0.5   | 31  |   |                                   |  |
| ATUM 32XD3 SOMT 11T308                             | ●                      | 32  | 32   | 44     | 183 | 96  | 123 | 60 | 0.5   | 33  |   |                                   |  |
| ATUM 33XD3 SOMT 11T308                             | ●                      | 33  | 32   | 44     | 186 | 99  | 126 | 60 | 0.5   | 34  |   |                                   |  |
| ATUM 34XD3 SOMT 11T308                             | ●                      | 34  | 32   | 44     | 189 | 102 | 129 | 60 | 0.5   | 35  |   |                                   |  |
| ATUM 35XD3 SOMT 11T308                             | ●                      | 35  | 32   | 44     | 192 | 105 | 132 | 60 | 0.5   | 36  |   |                                   |  |
| ATUM 36XD3 SOMT 11T308                             | ●                      | 36  | 32   | 44     | 195 | 108 | 135 | 60 | 0.4   | 36.8  |   |                                   |  |
| ATUM 37XD3 SOMT 130408                             | ●                      | 37  | 32   | 44     | 198 | 111 | 138 | 60 | 0.5   | 38  |   |                                   |  |
| ATUM 38XD3 SOMT 130408                             | ●                      | 38  | 32   | 44     | 201 | 114 | 141 | 60 | 0.5   | 39  |   |                                   |  |
| ATUM 39XD3 SOMT 130408                             | ●                      | 39  | 32   | 44     | 204 | 117 | 144 | 60 | 0.5   | 40  |   |                                   |  |
| ATUM 40XD3 SOMT 130408                             | ●                      | 40  | 32   | 44     | 207 | 120 | 147 | 60 | 0.5   | 41  |   |                                   |  |
| ATUM 45XD3 SOMT 150510                             | ●                      | 45  | 40   | 54     | 237 | 135 | 167 | 70 | 0.5   | 46  |   |                                   |  |
| ATUM 49XD3 SOMT 150510                             | ●                      | 49  | 40   | 54     | 249 | 147 | 179 | 70 | 0.5   | 50  |   |                                   |  |
| ATUM 50XD3 SOMT 150510                             | ●                      | 50  | 40   | 54     | 252 | 150 | 182 | 70 | 0.5   | 51  |   |                                   |  |

R: Sağ / Right / Rechts L: Sol / Left / Links

● Stokta / In Stock / Auf Lager ○ Stokta Yok / Non Stock Item / Kein Lagerartikel, Lieferzeit auf Anfrage  
TGTC Ucuna Uygundur. / Compatible with TGTC Insert. / Kompatibel mit TGTC Wendeplatten.

Sipariş Örneği/Ordering Example/Bestellbeispiel

1 ad./pcs./stück ATUM 14XD3 SOMT 050204

Takma Uçlu Matkap Kullanım Kılavuzu : S 375 / User's Guide For U-Drills : P 375

Bedienungsanleitung für Vollbohrer : S 375



Delme Derinliği  
Drilling Depth  
Bohrtiefe

= 4x Çap  
= 4x Diameter  
= 4x Durchmesser

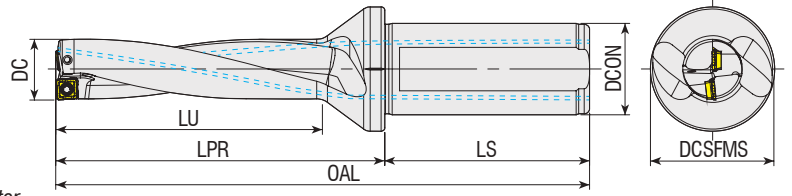

| Takım Kodu<br>Ordering Code<br>Bestell-Bezeichnung | Stok<br>Stock<br>Lager | Takım Ölçüleri (mm)<br>Dimension (mm)<br>Abmessung (mm) |      |        |     |     |     |    | Maks. Ofset (radyal)<br>Max. Offset (radial)<br>Max. Versatz (radial) | Kesici Uç<br>Insert<br>Wendeschneidplatte | Yedek Parçaları / Spare Parts / Ersatzteile |  |        |
|--|------------------------|---|------|--------|-----|-----|-----|----|---|---|---|--|--------|
|  |                        | DC  | DCON | DCSFMS | OAL | LU  | LPR | LS |   |   | Sıkma Vidası<br>Screw<br>Schraube           | Tork Anahtar<br>Torx Key<br>Torx-Schlüssel |        |
| ATUM 14XD4 SOMT 050204                             | ●                      | 14  | 20   | 25     | 128 | 56  | 78  | 50 | 0.5   | 15  | SOMT 050204                                 | 3006-M2x4                                  | 82-T06 |
| ATUM 14.5XD4 SOMT 050204                           | ●                      | 14.5  | 20   | 25     | 128 | 56  | 78  | 50 | 0.4   | 15.3                                      |   |  |        |
| ATUM 16XD4 SOMT 050204                             | ●                      | 16  | 25   | 34     | 142 | 64  | 86  | 56 | 0.3   | 16.6                                      |   |  |        |
| ATUM 17XD4 SOMT 060204                             | ●                      | 17  | 25   | 34     | 146 | 68  | 90  | 56 | 0.5   | 18  |   |  |        |
| ATUM 17.5XD4 SOMT 060204                           | ●                      | 17.5  | 25   | 34     | 146 | 68  | 90  | 56 | 0.4   | 18.3                                      | SOMT 060204                                 | 3007-M2.2x4.6                              | 82-T07 |
| ATUM 18XD4 SOMT 060204                             | ●                      | 18  | 25   | 34     | 150 | 72  | 94  | 56 | 0.4   | 18.8                                      |   |  |        |
| ATUM 19XD4 SOMT 060204                             | ●                      | 19  | 25   | 34     | 154 | 76  | 98  | 56 | 0.3   | 19.6                                      |   |  |        |
| ATUM 20XD4 SOMT 070306                             | ●                      | 20  | 25   | 34     | 158 | 80  | 102 | 56 | 0.5   | 21  | SOMT 070306                                 |  |        |
| ATUM 21XD4 SOMT 070306                             | ●                      | 21  | 25   | 34     | 162 | 84  | 106 | 56 | 0.4   | 21.8                                      |   |  |        |
| ATUM 22XD4 SOMT 070306                             | ●                      | 22  | 25   | 34     | 166 | 88  | 110 | 56 | 0.3   | 22.6                                      |   |  |        |
| ATUM 24XD4 SOMT 08T306                             | ●                      | 24  | 25   | 34     | 174 | 96  | 118 | 56 | 0.5   | 25  | SOMT 08T306                                 | 3008-M2.5x6                                | 82-T08 |
| ATUM 25XD4 SOMT 08T306                             | ●                      | 25  | 25   | 34     | 178 | 100 | 122 | 56 | 0.4   | 25.8                                      |   |  |        |

R: Sağ / Right / Rechts / L: Sol / Left / Links  
● Stokta / In Stock / Auf Lager ○ Stokta Yok / Non Stock Item / Kein Lagerartikel, Lieferzeit auf Anfrage  
TGTC Ucuına Uyğundur. / Compatible with TGTC Insert. / Kompatibel mit TGTC Wendeplatten.

Sipariş Örneği/Ordering Example/Bestellbeispiel  
1 ad./pcs./stück ATUM 14XD4 SOMT 050204  
Takma Uçlu Matkap Kullanım Kılavuzu : S 375 / User's Guide For U-Drills : P 375  
Bedienungsanleitung für Vollbohrer : S 375





Delme Derinliği  
Drilling Depth  
Bohrtiefe = 5x Çap  
= 5x Diameter  
= 5x Durchmesser

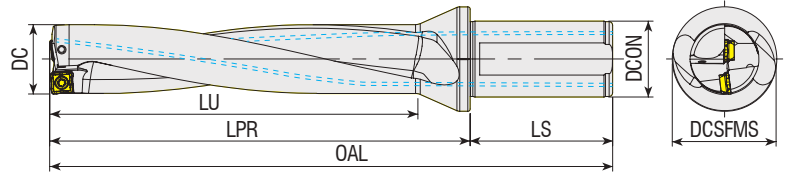

**Takım Kodu**  
**Ordering Code**  
**Bestell-Bezeichnung**

| Stok<br>Stock<br>Lager   | Takım Ölçüleri (mm)<br>Dimension (mm)<br>Abmessung (mm) |      |        |     |     |     |     |           | Maks. Ofset (radyal)<br>Max. Offset (radial)<br>Max. Versatz (radial) |                                   | Kesici Uç<br>Insert<br>Wendeschneidplatte | Yedek Parçaları / Spare Parts / Ersatzteile |        |
|--------------------------|---|------|--------|-----|-----|-----|-----|-----------|---|-----------------------------------|---|---|--------|
|                          | DC  | DCON | DCSFMS | OAL | LU  | LPR | LS  | $X_{max}$ | $DC_{max}$  | Sıkma Vidası<br>Screw<br>Schraube |   | Tork Anahtar<br>Torx Key<br>Torx-Schlüssel  |        |
| ATUM 14XD5 SOMT 050204   | ●   | 14   | 20     | 25  | 142 | 70  | 92  | 50        | 0.5   | 15                                | SOMT 050204                               | 3006-M2x4                                   | 82-T06 |
| ATUM 15XD5 SOMT 050204   | ●   | 15   | 20     | 25  | 147 | 75  | 97  | 50        | 0.4   | 15.8                              |   |   |        |
| ATUM 15.5XD5 SOMT 050204 | ●   | 15.5 | 20     | 25  | 147 | 75  | 97  | 50        | 0.3   | 16.1                              |   |   |        |
| ATUM 16XD5 SOMT 050204   | ●   | 16   | 25     | 34  | 158 | 80  | 102 | 56        | 0.3   | 16.6                              |   |   |        |
| ATUM 16.5XD5 SOMT 060204 | ●   | 16.5 | 25     | 34  | 158 | 80  | 102 | 56        | 0.5   | 17.5                              | SOMT 060204                               | 3007-M2.2x4.6                               | 82-T07 |
| ATUM 17.5XD5 SOMT 060204 | ●   | 17.5 | 25     | 34  | 163 | 85  | 107 | 56        | 0.4   | 18.3                              |   |   |        |
| ATUM 18XD5 SOMT 060204   | ●   | 18   | 25     | 34  | 168 | 90  | 112 | 56        | 0.4   | 18.8                              |   |   |        |
| ATUM 18.5XD5 SOMT 060204 | ●   | 18.5 | 25     | 34  | 168 | 90  | 112 | 56        | 0.3   | 19.1                              |   |   |        |
| ATUM 19XD5 SOMT 060204   | ●   | 19   | 25     | 34  | 173 | 95  | 117 | 56        | 0.3   | 19.6                              | SOMT 070306                               | 3008-M2.5x6                                 | 82-T08 |
| ATUM 19.5XD5 SOMT 070306 | ●   | 19.5 | 25     | 34  | 173 | 95  | 117 | 56        | 0.5   | 20.5                              |   |   |        |
| ATUM 20XD5 SOMT 070306   | ●   | 20   | 25     | 34  | 178 | 100 | 122 | 56        | 0.5   | 21                                |   |   |        |
| ATUM 21XD5 SOMT 070306   | ●   | 21   | 25     | 34  | 183 | 105 | 127 | 56        | 0.4   | 21.8                              |   |   |        |
| ATUM 22XD5 SOMT 070306   | ●   | 22   | 25     | 34  | 188 | 110 | 132 | 56        | 0.3   | 22.6                              | SOMT 08T306                               | 3008-M2.5x6                                 | 82-T08 |
| ATUM 23XD5 SOMT 08T306   | ●   | 23   | 25     | 34  | 193 | 115 | 137 | 56        | 0.5   | 24                                |   |   |        |
| ATUM 24XD5 SOMT 08T306   | ●   | 24   | 25     | 34  | 198 | 120 | 142 | 56        | 0.5   | 25                                |   |   |        |
| ATUM 25XD5 SOMT 08T306   | ●   | 25   | 25     | 34  | 203 | 125 | 147 | 56        | 0.4   | 25.8                              |   |   |        |
| ATUM 26XD5 SOMT 08T306   | ●   | 26   | 25     | 34  | 208 | 130 | 152 | 56        | 0.3   | 26.6                              | SOMT 09T308                               | 4015-M3.5x9                                 | 80-T15 |
| ATUM 27XD5 SOMT 09T308   | ●   | 27   | 25     | 34  | 213 | 135 | 157 | 56        | 0.5   | 28                                |   |   |        |
| ATUM 28XD5 SOMT 09T308   | ●   | 28   | 25     | 34  | 218 | 140 | 162 | 56        | 0.5   | 29                                |   |   |        |
| ATUM 29XD5 SOMT 09T308   | ●   | 29   | 25     | 34  | 223 | 145 | 167 | 56        | 0.5   | 30                                |   |   |        |
| ATUM 30XD5 SOMT 09T308   | ●   | 30   | 32     | 44  | 237 | 150 | 177 | 60        | 0.5   | 31                                | SOMT 11T308                               | 4015-M3.5x9                                 | 80-T15 |
| ATUM 33XD5 SOMT 11T308   | ●   | 33   | 32     | 44  | 252 | 165 | 192 | 60        | 0.5   | 34                                |   |   |        |
| ATUM 34XD5 SOMT 11T308   | ●   | 34   | 32     | 44  | 257 | 170 | 197 | 60        | 0.5   | 35                                |   |   |        |
| ATUM 35XD5 SOMT 11T308   | ●   | 35   | 32     | 44  | 262 | 175 | 202 | 60        | 0.5   | 36                                |   |   |        |
| ATUM 36XD5 SOMT 11T308   | ●   | 36   | 32     | 44  | 267 | 180 | 207 | 60        | 0.4   | 36.8                              |   |   |        |

R: Sağ / Right / Rechts L: Sol / Left / Links

● Stokta / In Stock / Auf Lager ○ Stokta Yok / Non Stock Item / Kein Lagerartikel, Lieferzeit auf Anfrage

TGTC Ucuna Uygun. / Compatible with TGTC Insert. / Kompatibel mit TGTC Wendeplatten.

Sipariş Örneği/Ordering Example/Bestellbeispiel

1 ad./pcs./stück ATUM 14XD5 SOMT 050204

Takma Uçlu Matkap Kullanım Kılavuzu : S 375 / User's Guide For U-Drills : P 375

Bedienungsanleitung für Vollbohrer : S 375



Delme Derinliği = 3x Çap  
Drilling Depth = 3x Diameter  
Bohrtiefe = 3x Durchmesser

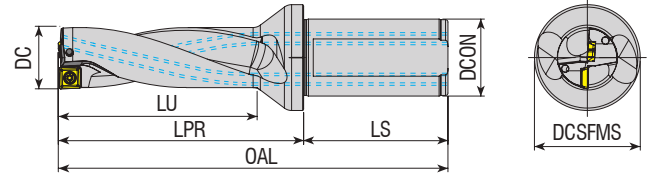

| Takım Kodu<br>Ordering Code<br>Bestell-Bezeichnung | Stok<br>Stock<br>Lager | Takım Ölçüleri (mm)<br>Dimension (mm)<br>Abmessung (mm) |      |        |     |     |     |    |                  | Maks. Ofset (radyal)<br>Max. Offset (radial)<br>Max. Versatz (radial) |              | Kesici Uç<br>Insert<br>Wendeschneidplatte | Sıkma Vidası<br>Screw<br>Schraube | Tork Anahtar<br>Torx Key<br>Torx-Schlüssel |
|--|------------------------|---|------|--------|-----|-----|-----|----|------------------|---|--------------|---|-----------------------------------|--|
|  |                        | DC  | DCON | DCSFMS | OAL | LU  | LPR | LS | X <sub>max</sub> | DC <sub>max</sub>   |              |   |                                   |  |
| ATUM 14XD3 880-0202..                              | ●                      | 14  | 20   | 25     | 108 | 42  | 58  | 50 | 0.5              | 15  | 880-02...C/P | 3006-M2x4                                 | 82-T06                            |  |
| ATUM 14.5XD3 880-0202..                            | ●                      | 14.5  | 20   | 25     | 110 | 46  | 60  | 50 | 0.45             | 15.4  |              |   |                                   |  |
| ATUM 15XD3 880-0202..                              | ●                      | 15  | 20   | 25     | 112 | 48  | 62  | 50 | 0.4              | 15.8  |              |   |                                   |  |
| ATUM 15.5XD3 880-0202..                            | ●                      | 15.5  | 20   | 25     | 114 | 50  | 64  | 50 | 0.3              | 16.1  |              |   |                                   |  |
| ATUM 16XD3 880-0202..                              | ●                      | 16  | 20   | 25     | 116 | 51  | 66  | 50 | 0.3              | 16.6  |              |   |                                   |  |
| ATUM 16.5XD3 880-0303..                            | ●                      | 16.5  | 20   | 25     | 118 | 53  | 68  | 50 | 0.6              | 17.7  | 880-03...C/P | 3007-M2.2x4.6                             | 82-T07                            |  |
| ATUM 17XD3 880-0303..                              | ●                      | 17  | 20   | 25     | 119 | 54  | 69  | 50 | 0.6              | 18.2  |              |   |                                   |  |
| ATUM 17.5XD3 880-0303..                            | ●                      | 17.5  | 25   | 32     | 128 | 56  | 72  | 56 | 0.5              | 18.5  |              |   |                                   |  |
| ATUM 18XD3 880-0303..                              | ●                      | 18  | 25   | 32     | 129 | 57  | 73  | 56 | 0.4              | 18.8  |              |   |                                   |  |
| ATUM 18.5XD3 880-0303..                            | ●                      | 18.5  | 25   | 32     | 131 | 59  | 75  | 56 | 0.4              | 19.3  |              |   |                                   |  |
| ATUM 19XD3 880-0303..                              | ●                      | 19  | 25   | 32     | 132 | 60  | 76  | 56 | 0.3              | 19.6  |              |   |                                   |  |
| ATUM 19.5XD3 880-0303..                            | ●                      | 19.5  | 25   | 32     | 135 | 62  | 79  | 56 | 0.3              | 20.1  |              |   |                                   |  |
| ATUM 20XD3 880-0403..                              | ●                      | 20  | 25   | 32     | 137 | 64  | 81  | 56 | 0.9              | 21.8  |              |   |                                   |  |
| ATUM 20.5XD3 880-0403..                            | ●                      | 20.5  | 25   | 32     | 138 | 65  | 82  | 56 | 0.8              | 22.1  |              |   |                                   |  |
| ATUM 21XD3 880-0403..                              | ●                      | 21  | 25   | 32     | 140 | 66  | 84  | 56 | 0.8              | 22.6  |              |   |                                   |  |
| ATUM 21.5XD3 880-0403..                            | ●                      | 21.5  | 25   | 32     | 142 | 68  | 86  | 56 | 0.7              | 22.9  |              |   |                                   |  |
| ATUM 22XD3 880-0403..                              | ●                      | 22  | 25   | 32     | 143 | 69  | 87  | 56 | 0.6              | 23.2  |              |   |                                   |  |
| ATUM 22.5XD3 880-0403..                            | ●                      | 22.5  | 25   | 32     | 146 | 71  | 90  | 56 | 0.5              | 23.5  |              |   |                                   |  |
| ATUM 23XD3 880-0403..                              | ●                      | 23  | 25   | 32     | 147 | 72  | 91  | 56 | 0.5              | 24  |              |   |                                   |  |
| ATUM 23.5XD3 880-0403..                            | ●                      | 23.5  | 25   | 34     | 149 | 69  | 93  | 56 | 0.4              | 24.3  |              |   |                                   |  |
| ATUM 24XD3 880-0503..                              | ●                      | 24  | 25   | 32     | 151 | 76  | 95  | 56 | 1.1              | 26.2  | 880-05...C/P | 4010-M3x8                                 |                                   |  |
| ATUM 25XD3 880-0503..                              | ●                      | 25  | 25   | 32     | 155 | 79  | 99  | 56 | 1                | 27  |              |   |                                   |  |
| ATUM 26XD3 880-0503..                              | ●                      | 26  | 32   | 44     | 162 | 81  | 102 | 60 | 0.9              | 27.8  |              |   |                                   |  |
| ATUM 27XD3 880-0503..                              | ●                      | 27  | 32   | 44     | 165 | 84  | 105 | 60 | 0.7              | 28.4  |              |   |                                   |  |
| ATUM 28XD3 880-0503..                              | ●                      | 28  | 32   | 44     | 169 | 87  | 109 | 60 | 0.6              | 29.2  |              |   |                                   |  |
| ATUM 29XD3 880-0503..                              | ●                      | 29  | 32   | 44     | 172 | 90  | 112 | 60 | 0.5              | 30  |              |   |                                   |  |
| ATUM 30XD3 880-0604..                              | ●                      | 30  | 32   | 44     | 177 | 94  | 117 | 60 | 1.1              | 32.2  |              |   |                                   |  |
| ATUM 31XD3 880-0604..                              | ●                      | 31  | 40   | 54     | 191 | 97  | 121 | 70 | 1                | 33  | 880-06...C/P | 3010-M3.5x9                               | 82-T10                            |  |
| ATUM 32XD3 880-0604..                              | ●                      | 32  | 40   | 54     | 194 | 100 | 124 | 70 | 0.9              | 33.8  |              |   |                                   |  |
| ATUM 33XD3 880-0604..                              | ●                      | 33  | 40   | 54     | 198 | 103 | 128 | 70 | 0.7              | 34.4  |              |   |                                   |  |
| ATUM 34XD3 880-0604..                              | ●                      | 34  | 40   | 54     | 201 | 106 | 131 | 70 | 0.5              | 35  |              |   |                                   |  |
| ATUM 35XD3 880-0604..                              | ●                      | 35  | 40   | 54     | 205 | 109 | 135 | 70 | 0.4              | 35.8  |              |   |                                   |  |
| ATUM 36XD3 880-0704..                              | ●                      | 36  | 40   | 54     | 209 | 112 | 139 | 70 | 1.3              | 38.6  |              |   |                                   |  |
| ATUM 38XD3 880-0704..                              | ●                      | 38  | 40   | 54     | 216 | 118 | 146 | 70 | 1.1              | 40.2  | 880-07...C/P | 3010-M3.5x9                               |                                   |  |
| ATUM 39XD3 880-0704..                              | ●                      | 39  | 40   | 54     | 219 | 121 | 149 | 70 | 1                | 41  |              |   |                                   |  |
| ATUM 40XD3 880-0704..                              | ●                      | 40  | 40   | 54     | 223 | 124 | 153 | 70 | 0.8              | 41.6  |              |   |                                   |  |
| ATUM 41XD3 880-0704..                              | ●                      | 41  | 40   | 54     | 227 | 127 | 157 | 70 | 0.7              | 42.4  |              |   |                                   |  |
| ATUM 42XD3 880-0704..                              | ●                      | 42  | 40   | 54     | 230 | 130 | 160 | 70 | 0.6              | 43.2  |              |   |                                   |  |
| ATUM 45XD3 880-0805..                              | ●                      | 45  | 40   | 54     | 242 | 140 | 172 | 70 | 1.4              | 47.8  |              |   |                                   | 880-08...C/P                               |
| ATUM 46XD3 880-0805..                              | ●                      | 46  | 40   | 54     | 246 | 143 | 176 | 70 | 1.3              | 48.6  |              |   |                                   |  |
| ATUM 48XD3 880-0805..                              | ●                      | 48  | 40   | 54     | 253 | 149 | 183 | 70 | 1                | 50  |              |   |                                   |  |
| ATUM 50XD3 880-0805..                              | ●                      | 50  | 40   | 54     | 260 | 155 | 190 | 70 | 0.8              | 51.6  |              |   |                                   |  |

R: Sağ / Right / Rechts/ L: Sol / Left / Links

● Stokta / In Stock / Auf Lager ○ Stokta Yok / Non Stock Item / Kein Lagerartikel, Lieferzeit auf Anfrage

SNDVK Ucuna Uygundur. / Compatible with SNDVK Insert. / Kompatibel mit SNDVK Wendeplatten.

Sipariş Örneği/Ordering Example/Bestellbeispiel

1 ad./pcs./stück ATUM 14XD3 880-0202..

Takma Uçlu Matkap Kullanım Kılavuzu : S 375 / User's Guide For U-Drills : P 375

Bedienungsanleitung für Vollbohrer : S 375



# HELİSEL İÇTEN SU VERME KANALLI MATKAPLAR

## INDEXABLE DRILLS WITH HELICAL COOLANT HOLE

Farklı çaplarda ve ALFA KAPLAMA teknolojisi ile siparişe hazır.

**They are ready to order in different diameters and with ALPHA COATING technology.**

- Helisel içten su verme kanallı • **Helical Internal Coolant Holes**
- Üstün Alpha Kaplama Teknolojisi • **Superior Alpha Coating Technology**
- 1000 Vickers'e dayanan yüksek yüzey sertliği • **High surface hardness up to 1000 Vickers**
- Aşınmaya karşı yüksek direnç • **High resistance to abrasion**
- Dengeli ve hassas kesim • **Balanced and precise cutting**

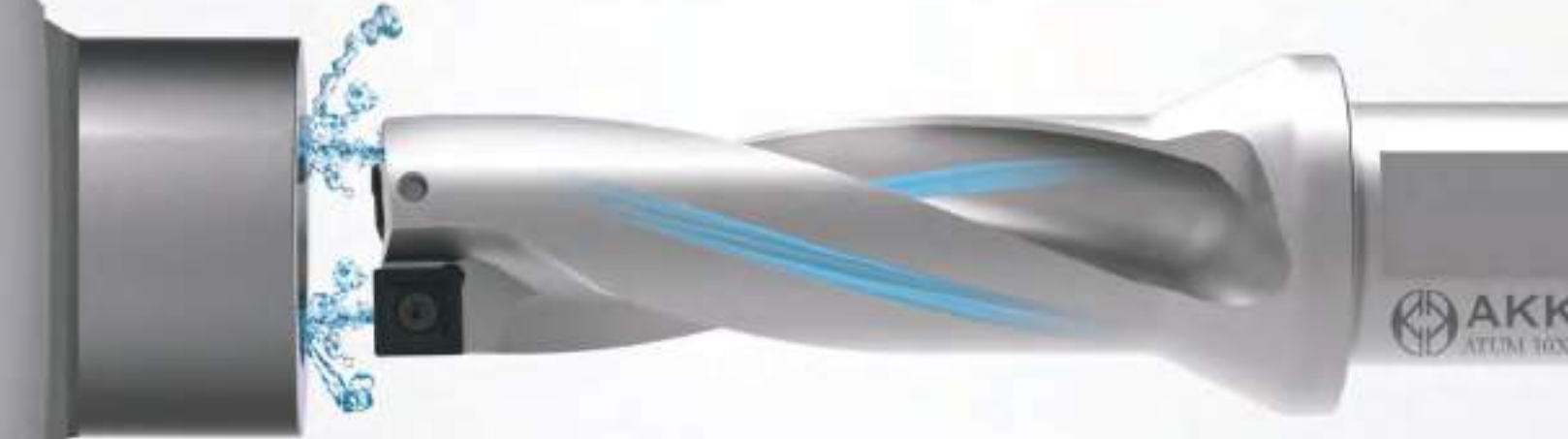

AKKO HELİSEL KANAL TEKNOLOJİSİ/  
AKKO HELICAL CHANNEL TECHNOLOGY

RAKİPLER  
COMPETITORS

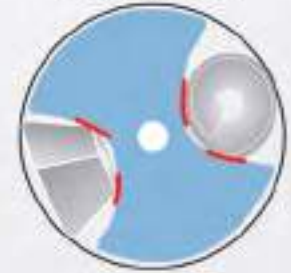

\* STOK DURUMU / STOCK STATUS

**D2 / D3 / D4 / D5**

\* Helisel İçten Su Verme Kanalı  
Twisted Coolant Hole

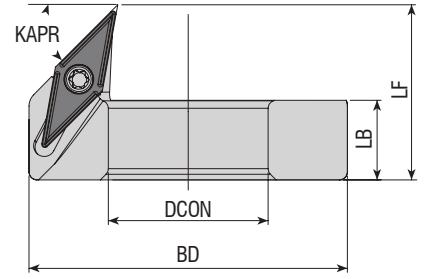

**Takım Kodu**  
**Ordering Code**  
**Bestell-Bezeichnung**

Stok  
Stock  
Lager

Takım Ölçüleri (mm)  
Dimension (mm)  
Abmessung (mm)

Kullanılacak  
ATUM Ölçüsü  
Compatible  
ATUM Diameter  
Kompatibler  
Vollbohrer

Yedek Parçaları / Spare Parts / Ersatzteile

Kesici Uç  
Insert  
Wendeschneidplatte

Sıkma Vidası  
Screw  
Schraube

Tork Anahtar  
Torx Key  
Torx-Schlüssel

Montaj Vidası  
Mounting Screw  
Befestigungsschraube

Montaj Vida Anahtar  
Mounting Screw Key  
Befestigungsschraubenschlüssel

BD DCON LB LF ATUM Ø

|                 |   |      |      |    |    |         |
|-----------------|---|------|------|----|----|---------|
| ADCR-120-VB1103 | ● | 32   | 12   | 10 | 22 | 12.5    |
| ADCR-125-VB1103 | ● | 32.5 | 12.5 | 10 | 22 | 13      |
| ADCR-130-VB1103 | ● | 33   | 13   | 10 | 22 | 13.5    |
| ADCR-135-VB1103 | ● | 33.5 | 13.5 | 10 | 22 | 14      |
| ADCR-140-VB1103 | ● | 34   | 14   | 10 | 22 | 14.5    |
| ADCR-145-VB1103 | ● | 34.5 | 14.5 | 10 | 22 | 15      |
| ADCR-150-VB1103 | ● | 35   | 15   | 10 | 22 | 15.5-16 |
| ADCR-155-VB1103 | ● | 35.5 | 15.5 | 10 | 22 | 16.5    |
| ADCR-160-VB1103 | ● | 36   | 16   | 10 | 22 | 17      |
| ADCR-165-VB1103 | ● | 36.5 | 16.5 | 10 | 22 | 17.5    |
| ADCR-170-VB1103 | ● | 37   | 17   | 10 | 22 | 18      |
| ADCR-175-VB1103 | ● | 37.5 | 17.5 | 10 | 22 | 18.5    |
| ADCR-180-VB1103 | ● | 38   | 18   | 10 | 22 | 19      |
| ADCR-185-VB1103 | ● | 38.5 | 18.5 | 10 | 22 | 19.5    |
| ADCR-190-VB1103 | ● | 39   | 19   | 10 | 22 | 20      |
| ADCR-195-VB1103 | ● | 39.5 | 19.5 | 10 | 22 | 20.5    |
| ADCR-200-VB1103 | ● | 40   | 20   | 10 | 22 | 21      |
| ADCR-205-VB1103 | ● | 40.5 | 20.5 | 10 | 22 | 21.5    |
| ADCR-210-VB1103 | ● | 41   | 21   | 10 | 22 | 22      |
| ADCR-215-VB1103 | ● | 41.5 | 21.5 | 10 | 22 | 22.5    |
| ADCR-220-VB1103 | ● | 42   | 22   | 10 | 22 | 23      |
| ADCR-225-VB1103 | ● | 42.5 | 22.5 | 10 | 22 | 23.5    |
| ADCR-230-VB1103 | ● | 43   | 23   | 10 | 22 | 24      |
| ADCR-235-VB1103 | ● | 43.5 | 23.5 | 10 | 22 | 24.5    |
| ADCR-240-VB1103 | ● | 44   | 24   | 10 | 22 | 25      |
| ADCR-245-VB1103 | ● | 44.5 | 24.5 | 10 | 22 | 25.5    |
| ADCR-250-VB1103 | ● | 45   | 25   | 10 | 22 | 26      |
| ADCR-255-VB1103 | ● | 45.5 | 25.5 | 10 | 22 | 26.5    |
| ADCR-260-VB1103 | ● | 46   | 26   | 10 | 22 | 27      |
| ADCR-265-VB1103 | ● | 46.5 | 26.5 | 10 | 22 | 27.5    |
| ADCR-270-VB1103 | ● | 47   | 27   | 10 | 22 | 28      |
| ADCR-275-VB1103 | ● | 47.5 | 27.5 | 10 | 22 | 28.5    |
| ADCR-280-VB1103 | ● | 48   | 28   | 10 | 22 | 29      |
| ADCR-285-VB1103 | ● | 48.5 | 28.5 | 10 | 22 | 29.5    |
| ADCR-290-VB1103 | ● | 49   | 29   | 10 | 22 | 30      |
| ADCR-295-VB1103 | ● | 49.5 | 29.5 | 10 | 22 | 30.5    |
| ADCR-300-VB1103 | ● | 50   | 30   | 10 | 22 | 31      |

VB.T 1103..

4008-M2.5x6

82-T08

AAV-14-M5x14

AAL-03-3

R: Sağ / Right / Rechts / L: Sol / Left / Links

● Stokta / In Stock / Auf Lager ○ Stokta Yok / Non Stock Item / Kein Lagerartikel, Lieferzeit auf Anfrage  
ISO Uçuna Uygundur. / Compatible with ISO Insert. / Kompatibel mit ISO Wendeplatten.

Sipariş Örneği/Ordering Example/Bestellbeispiel

1 ad./pcs./stück ADCR-120-VB1103

Delik Pahlama Bileziği Kullanım Kılavuzu : S 219 / User's Guide For Drill Chamfering Ring Tools : P 219

Technische Information Für Bohrer-Fasringwerkzeuge: P 219

Tavsiye Edilen / Recommended / Empfehlung

A

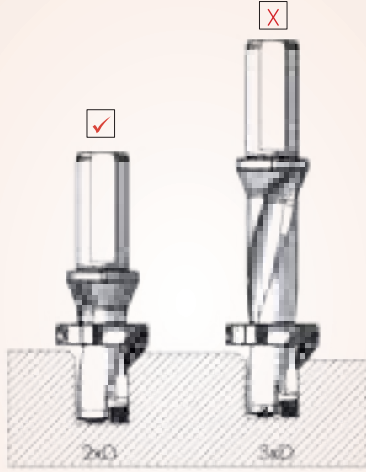

Mümkünse, her zaman kısa bir delme takımı kullanın. Değilse, titreşimi en aza indirmek için kesme hızını azaltın.  
If possible, use it always short drilling tools. Otherwise, reduce your speeds to minimize vibration.  
Bitte möglichst kurze Bohrwerkzeuge verwenden. Sollte dies nicht möglich sein, reduzieren Sie bitte die Geschwindigkeit, um Vibrationen zu vermeiden.

B



Mümkün olduğunca pah kırma halkasını shaft kısmına yakın montaj yap.  
Get close to the mounting shaft of the chamfering ring as possible.  
Befestigen Sie den Fasring möglichst nah am Schaft.

C



Daha iyi uç ömrü için harici soğutucu ve matkap ucu iç soğutucu uygulamak.  
Apply external cooling and internal coolant drill for a better life for inserts.  
Setzen Sie innere und äußere Kühlung ein, um die Standzeit der Wendeplatten zu erhöhen.

Montaj Şekli / Mounting System / Montage-Hinweise

1



Matkap gövdesi üzerine pah kırma halkasını takın.  
Put the chamfering ring to drill body.  
Schieben Sie den Fasring auf den Bohrkörper.

2



İstenilen konuma pah kırma halkasını kaydırın.  
Please slide chamfering ring to the desired position.  
Befestigen Sie den Fasring an der gewünschten Position.

3



Pah kırma halkasını talaş akışına mani olmayacak şekilde helis başlangıcına denk getirin.  
Please keep chamfering ring position which will not resist to fluiding chips and try to be equal to the helix start points.  
Positionieren Sie den Fasring bündig mit der Bohrerspirale um einen problemlosen Späne-transport zu gewährleisten.

4

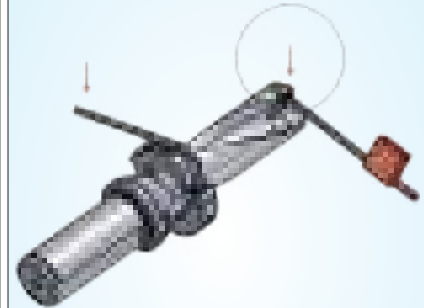

Pah kırma halkasını sıkın ve matkabin uçlarını takın.  
Tightening the chamfering ring and put the drill insert.  
Den Fasring festziehen und die Bohr-Wendeplatten einbauen.

Pah kırma halkasının doğru montaj şekli.  
Proper installation of chamfering rings.  
Korrekte Montage des Fasrings.

✓

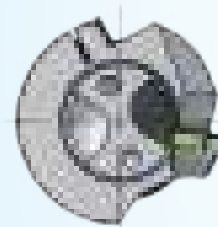

✗

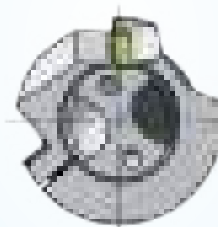

✗



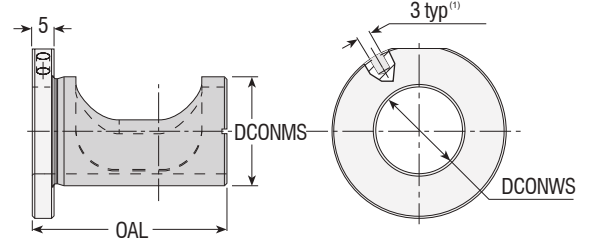

**Takım Kodu**  
**Ordering Code**  
**Bestell-Bezeichnung**

Stok  
 Stock  
 Lager

Takım Ölçüleri (mm)  
 Dimension (mm)  
 Abmessung (mm)

| Takım Kodu / Ordering Code / Bestell-Bezeichnung | Stok / Stock / Lager | DCON | BD | LF |
|--|----------------------|------|----|----|
| AET-2025   | ●                    | 20   | 25 | 44 |
| AET-2532   | ●                    | 25   | 32 | 46 |
| AET-3240   | ●                    | 32   | 40 | 55 |

■ <sup>(1)</sup>Delik ince bir metal yardımıyla adaptörün radyal olarak ayarlanmasını kolaylaştırmak için kullanılır. / Holes for inserting a pin, used to facilitate radial adjustment of the sleeve (pin not supplied).  
 Bohrung zum Einsetzen eines Stiftes mit dem der Adapter radial eingestellt werden kann (Stift ist nicht im Lieferumfang enthalten).

Frezeleme tezgahında takma uçlu matkabın nominal çapı, matkabın ekseninin, spindle eksenine göre ötelenmesiyle değiştirilebilir.  
 On a milling machine the drill's nominal diameter can be changed by shifting the drill's axis out of the tool spindle.

Auf einer Fräsmaschine kann die Nennweite des Bohrers durch Verschieben der Bohrerachse aus der Spindelachse verändert werden.

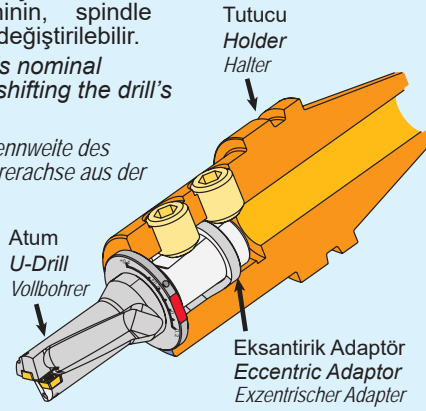

Radyal ayarlama pimi. (Verilmeyecektir.)  
 Radial adjustment pin. (not supplied)  
 Radial - Einstellstift (nicht im Lieferumfang)

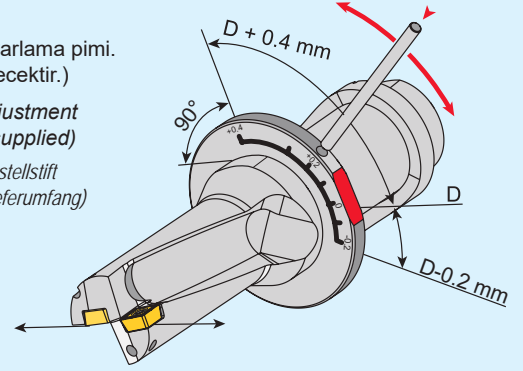

D-0.2  
 Eksantrik Adaptörü Kullanırken (AET) Tavsiye Edilen İlerleme Hızı  
 Recommended Feed When Using Eccentric Adaptor  
 Empfohlener Vorschub bei Einsatz des exzentrischen Adapters

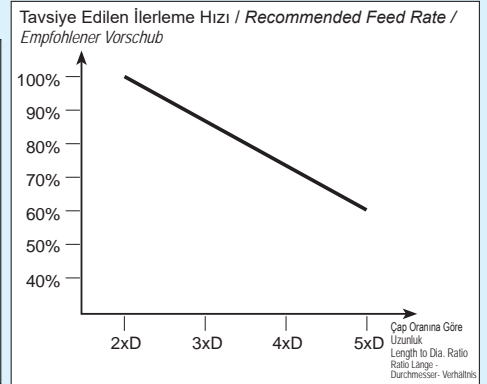
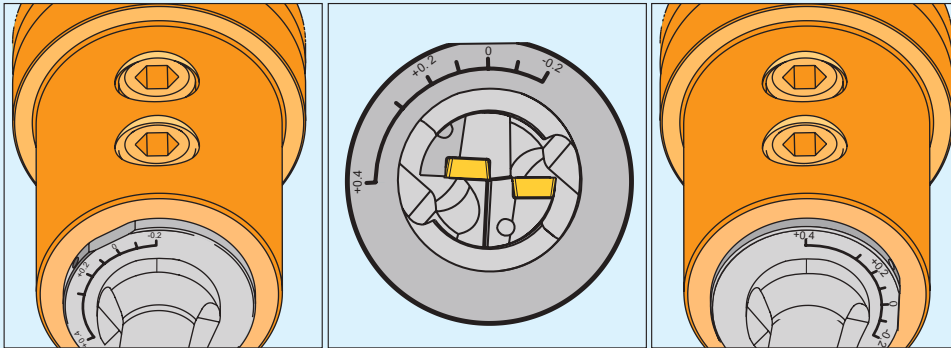

Delik Çapı  
 24.8 mm  
 Hole Diameter  
 Lochdurchmesser

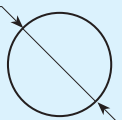

U-Drill Çapı = 25 mm  
 Drill Diameter = 25 mm  
 Vollbohrer Durchmesser = 25mm

Delik Çapı  
 25 mm  
 Hole Diameter  
 Lochdurchmesser

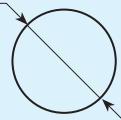

U-Drill Çapı = 25 mm  
 Drill Diameter = 25 mm  
 Vollbohrer Durchmesser = 25mm

Delik Çapı  
 25.4 mm  
 Hole Diameter  
 Lochdurchmesser

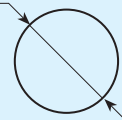

U-Drill Çapı = 25 mm  
 Drill Diameter = 25 mm  
 Vollbohrer Durchmesser = 25mm

ATUM'un üzerindeki düz çizgi adaptörün sıfır rakamının üzerine konulmalıdır. AET'nin (eksantrik adaptörün) çevrilmesini kolaylaştırmak için AET'nin üzerindeki deliğe, metal bir çubuk ya da vida anahtarları yerleştirilebilir. AET'yi ayarlama öncesi tutucunun vidasını hafifçe çözün.

The adjustment markings should be located perpendicular to the flat on the circumference of the U-DRILL flange. To facilitate the rotation of the adaptor, a metal rod or a screw key may be inserted into a hole on the eccentric adaptor flange. Unlock adapter screw before adjusting adaptor.

Die Einstellmarkierung sollte senkrecht zur Fläche des Bohrerschaftes stehen. Zum Drehen des Adapters sollte ein Stift in die Bohrung am Adapterflansch eingesetzt werden. Lösen Sie die Adapter-Schraube vor dem Einstellen des Adapters.

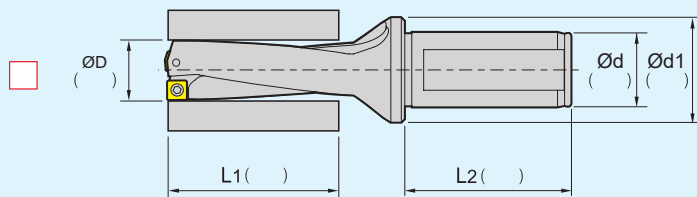
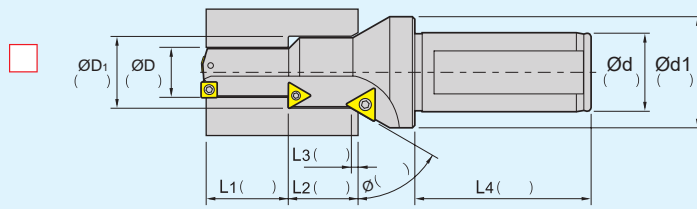
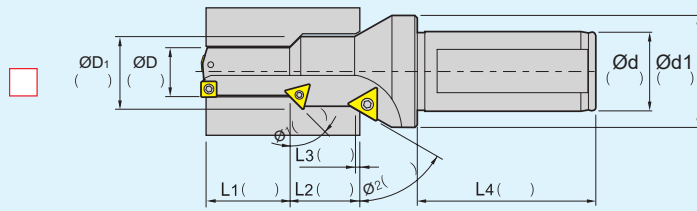
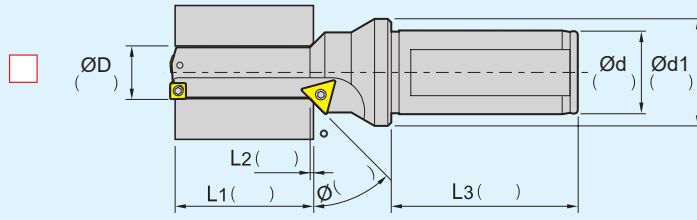
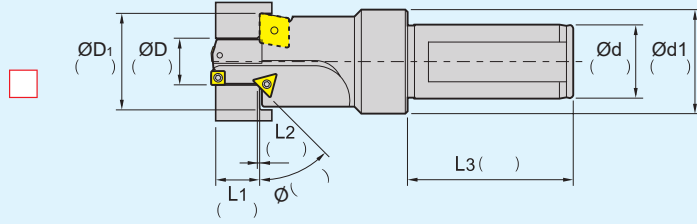

• Soğutma Tipi / Coolant type / Kühlmittelanschluss

- Yağ Deliği Dalma Kismında  
Oil Hole On the Plunge Part  
Kühlmittelzuführung über den Bund
- Yağ Deliği Şaft Kismında  
"Oil hole On the Shank"  
Kühlmittelbohrung durch den Schaft

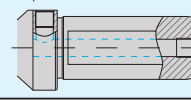

• Delik Tipi / Hole Type / Bohrungstyp

- Kapalı Delik  
Blind Hole  
Grundbohrung
- Açık Delik  
Thru Hole  
Durchgangsbohrung

• Şaft Tipleri / Types of Shank / Schaftausführung

- Düz Tip  
Flat Type  
Bohrungstyp
- Weldon Tip  
Weldon Type  
Weldon-Schaft
- Eğimli Yargı Tipi  
Whistle Notch Type  
Whistle-Notch-Schaft

• Yargı Bağlama Yeri / Location of Side Lock / Position der Spannfläche

- Dış Uca Parellel (Standart)  
Parallel to Peripheral Insert (Standard)  
Parallel zur äußeren Wendeplatte
- Dış Uca 90° Açılı  
90° angle to peripheral insert  
90° außen abgewinkelt
- Dış Uca 150° Açılı  
150° angle to peripheral insert  
150° außen abgewinkelt
- Dış Uca 180° Açılı  
180° angle to peripheral insert  
180° außen abgewinkelt

• Not / Note / Hinweis :

- Şu Anki Kullanılan Takım / Currently Using Tool
- Aktuell verwendetes Werkzeug
- Şu Anki Kesme Durumu / Current Cutting Condition
- Aktuelle Schnittbedingungen
- RPM ya da vc(m/min) / - RPM or vc(m/min)
- Umdrehungen pro Minute oder vc (m/min.)
- vf(mm/min) ya da fn(mm/rev)
- vf(mm/min) or fn(mm/rev) vf (mm/min.) oder fn (mm/Umdr.)
- Kesme Derinliği / Depth of Cut(mm)
- Schnitttiefe (mm)
- Ölçülen Standart Takım Ömrü / Standard of Measuring Tool Life
- Standzeit des Werkzeugs
- Şu Anki Kullanılan Makinalar / Currently Using Machine
- Aktuell eingesetzte Maschine
- İşleme Merkezi / Machining Center
- Bearbeitungszentrum
- Genel Torna / General Lathe
- Drehmaschine
- CNC Torna / CNC Lathe
- CNC-Drehmaschine



*konusulan  
the spoken kalite...  
quality...*

# EKONOMİK KESİCİLER

**EKONOMİK KESİCİLER**

MULTI FUNCTIONAL CUTTING TOOLS

MULTIFUNKTIONALES DREH- UND BOHRWERKZEUG





AKKO **A** **EK** **R** - **D2.25** x **20**

**X** **C** ■ ■ **10** **T3** **04**

**2** Kesiş Stili / Cutter Style / Werkzeugtyp  
EK : Ekonomik Kesici / Economic Cutting  
Multifunktionales Dreh- und Bohrwerkzeug

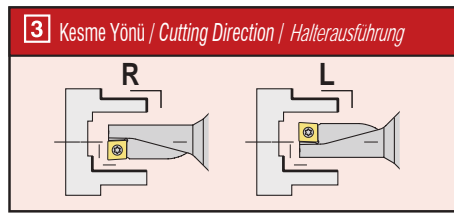

**11** Kalınlık / Thickness / Dicke

01 s = 1.59  
T1 s = 1.98  
02 s = 2.38  
T2 s = 2.78  
03 s = 3.18  
T3 s = 3.97  
04 s = 4.76  
05 s = 5.56  
06 s = 6.35  
07 s = 7.94  
09 s = 9.52

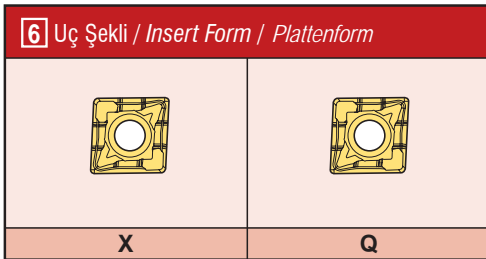
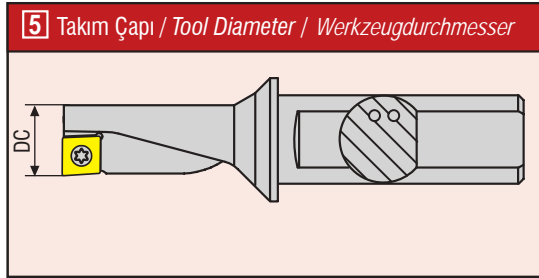
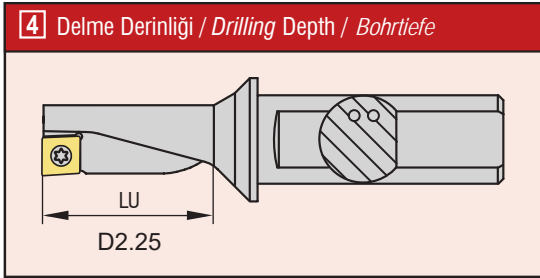

**8** Toleranslar / Tolerance Classes / Toleranzen

|   | IC          | M           | S       |
|---|-------------|-------------|---------|
| A | ± 0.025     | ± 0.005     | ± 0.025 |
| C | ± 0.025     | ± 0.013     | ± 0.025 |
| E | ± 0.025     | ± 0.025     | ± 0.025 |
| F | ± 0.013     | ± 0.005     | ± 0.025 |
| G | ± 0.025     | ± 0.025     | ± 0.130 |
| H | ± 0.013     | ± 0.013     | ± 0.025 |
| J | ± 0.05-0.15 | ± 0.005     | ± 0.025 |
| K | ± 0.05-0.15 | ± 0.013     | ± 0.025 |
| L | ± 0.05-0.15 | ± 0.025     | ± 0.025 |
| M | ± 0.05-0.15 | ± 0.08-0.20 | ± 0.130 |
| N | ± 0.05-0.15 | ± 0.08-0.20 | ± 0.025 |
| U | ± 0.08-0.25 | ± 0.13-0.38 | ± 0.130 |

IC : Daire Ölçüsü / Inscribed Circle  
M : Şekle Göre / Refer to Figure  
S : Kalınlık / Thickness

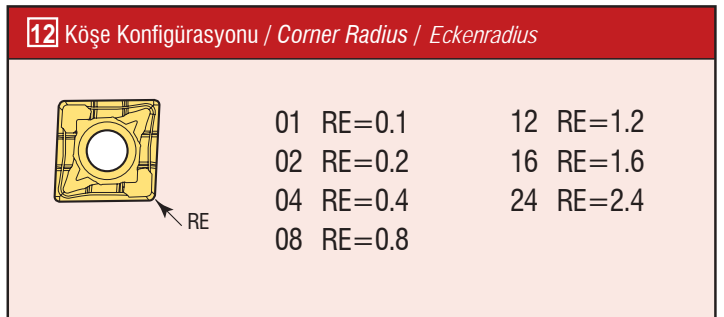
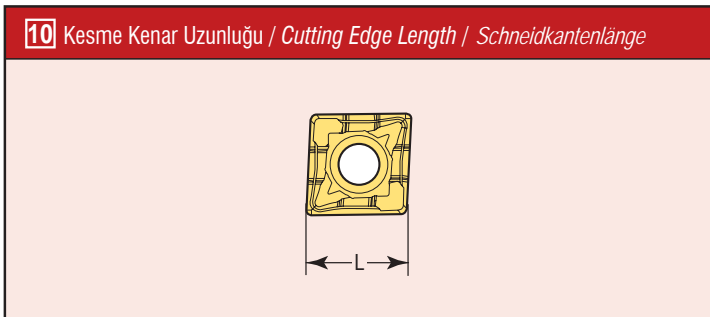
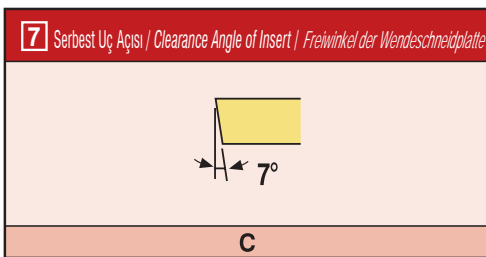
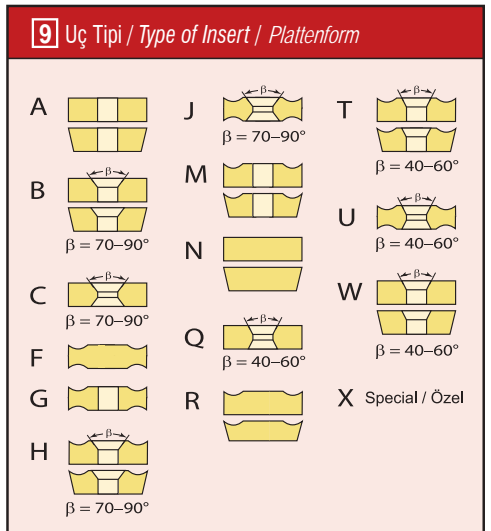

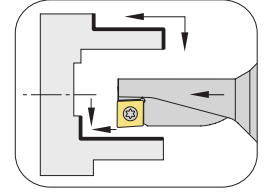
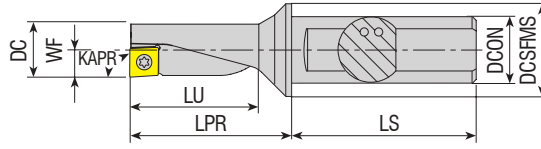

| Takım Kodu<br>Ordering Code<br>Bestell-Bezeichnung | Stok<br>Stock<br>Lager |   | Takım Ölçüleri (mm)<br>Dimension (mm)<br>Abmessung (mm) |      |        |      |      |    |      | Kesici Uç<br>Insert<br>Wendeschneidplatte | Yedek Parçaları / Spare Parts / Ersatzteile |        |
|--|------------------------|---|---|------|--------|------|------|----|------|---|---|--------|
|  | R                      | L | DC  | DCON | DCSFMS | LU   | LPR  | LS | WF   | Sıkma Vidası<br>Screw<br>Schraube         | Tork Anahtar<br>Torx Key<br>Torx-Schlüssel  |        |
| AEKR/L-D2.25X8 XC.. 040104                         | ●                      | ● | 8   | 10   | 12     | 18   | 22   | 38 | 4    | <b>XC.. 040104</b>                        | 3006-M1.8x4                                 | 82-T06 |
| AEKR/L-D2.25X10 XC.. 050204                        | ●                      | ● | 10  | 12   | 16     | 22.5 | 27.5 | 42 | 5    | <b>XC.. 050204</b>                        | 3006-M2x4                                   | 82-T07 |
| AEKR/L-D2.25X12 XC.. 060204                        | ●                      | ● | 12  | 16   | 20     | 27   | 33   | 45 | 6    | <b>XC.. 060204</b>                        | 3007-M2.2x4.6                               | 82-T08 |
| AEKR/L-D2.25X14 XC.. 070304                        | ●                      | ● | 14  | 16   | 20     | 31.5 | 38   | 45 | 7    | <b>XC.. 070304</b>                        | 3008-M2.5x6                                 | 82-T15 |
| AEKR/L-D2.25X16 XC.. 080304                        | ●                      | ● | 16  | 20   | 25     | 36   | 44   | 50 | 8    | <b>XC.. 080304</b>                        | 3008-M3x6                                   | 80-T20 |
| AEKR/L-D2.25X18 XC.. 09T304                        | ●                      | ● | 18  | 25   | 32     | 40.5 | 53.5 | 56 | 9    | <b>XC.. 09T304</b>                        | 4015-M3.5x9                                 |        |
| AEKR/L-D2.25X20 XC.. 10T304                        | ●                      | ● | 20  | 25   | 32     | 45   | 55   | 56 | 10   | <b>XC.. 10T304</b>                        | 4020-M4.5x10                                |        |
| AEKR/L-D2.25X25 XC.. 130404                        | ●                      | ● | 25  | 32   | 40     | 56.5 | 69   | 60 | 12.5 | <b>XC.. 130404</b>                        | 4020-M4.5x12                                |        |
| AEKR/L-D2.25X32 XC.. 170504                        | ●                      | ● | 32  | 32   | 50     | 72   | 88   | 60 | 16   | <b>XC.. 170504</b>                        |   |        |

R: Sağ / Right / Rechts / L: Sol / Left / Links  
 ● Stokta / In Stock / Auf Lager ○ Stokta Yok / Non Stock Item / Kein Lagerartikel, Lieferzeit auf Anfrage  
 CRTZT-ISCR-TGTC-KRLY Ucuna Uygunudur. / Compatible with CRTZT-ISCR-TGTC-KRLY Insert.

Kompatibel mit CRTZT-ISCR-TGTC-KRLY

Sipariş Örneği/Ordering Example/Bestellbeispiel  
 1 ad./pcs./stück AEKR-D2.25X8 XC.. 040104

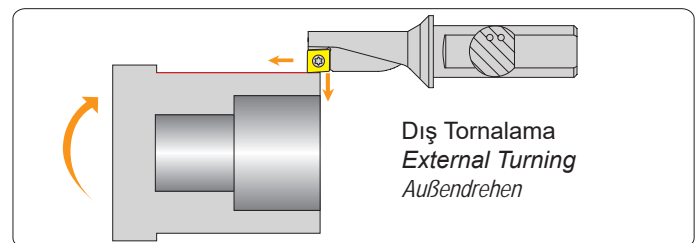
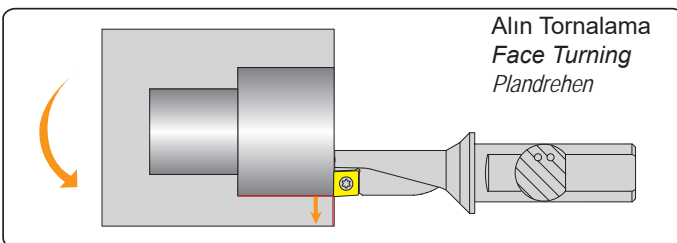
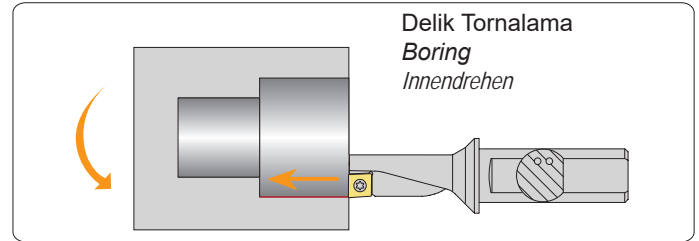
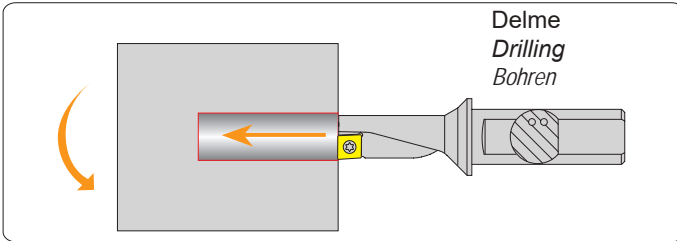
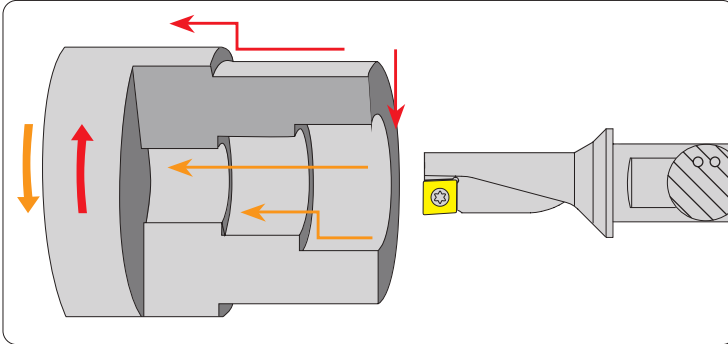



# BARALAR

**AYARLI DELİK İŞLEME BARALARI**  
ADJUSTABLE BORING HEADS  
EINSTELLBARE SPINDELKÖPFE

*konusulan*  
*the spoken kalite...*  
*quality...*



AKKO **A** **BH** **R** - **D18x22**

**W16** - **L90** - **CC06**

**2** Kesiş Stili / Cutter Style / Werkzeugtyp

BH : Delik İşleme / Boring Head  
Spindelkopf

**3** İşlem Tipi / Cutter Type / Einsatzgebiet

R : Kaba Baralama / Rough Boring  
Schruppbearbeitung  
F : Hassas Baralama / Fine Boring  
Schlichtbearbeitung

**5** Montaj Formu / Assembly Form / Schaffform

W : Weldon

**4** Ölçü Aralığı / Boring Range / Bohrbereich

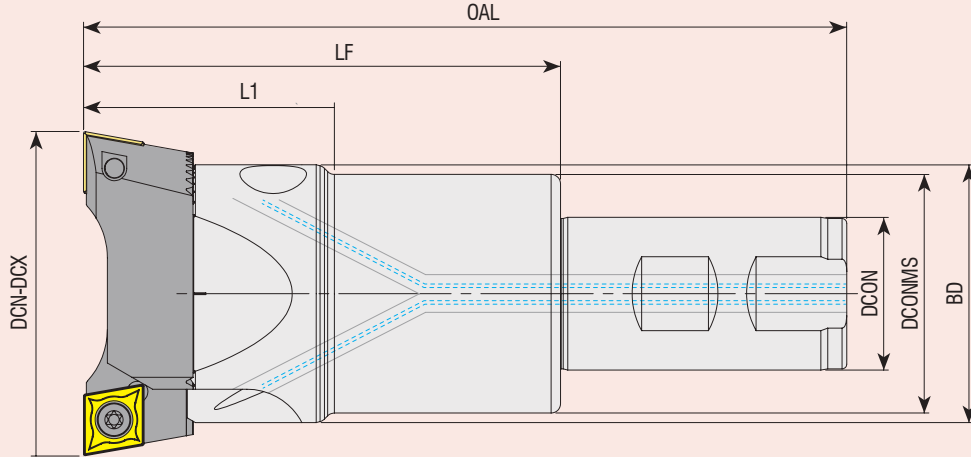

**6** Takım Boyu / Tool Length / Werkzeuglänge

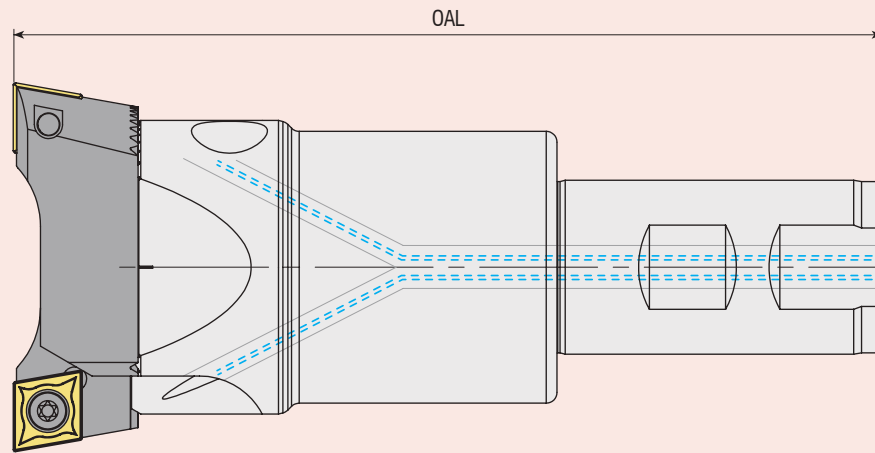

**7** Kesici Uç / Insert / Wendeschneidplatte

CC06 : CC.. 0602..  
CC09 : CC.. 09T3..  
CC12 : CC.. 1204..

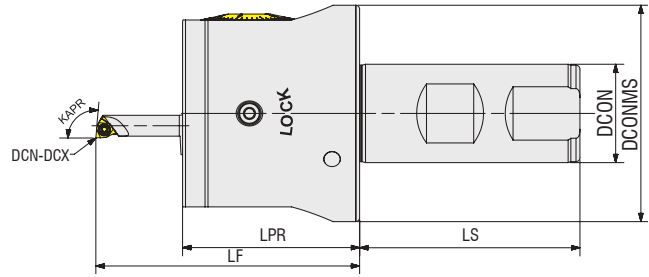

| Takım Kodu<br>Ordering Code<br>Bestell-Bezeichnung | Stok<br>Stock<br>Lager | Ölçü Aralığı<br>Boring Range<br>Bohrbereich<br>DCN-DCX | Takım Ölçüleri (mm)<br>Dimension (mm)<br>Abmessung (mm) |     |    |      |        |      |     | Kartuş<br>Cartridge<br>Kurzdrehalter | Kesici Uç<br>Insert<br>Wendeschneidplatte | Bara Gövde Takım Kodu<br>Boring Head Body Code<br>Trägerwerkzeug-Bezeichnung |                   |
|--|------------------------|--|---|-----|----|------|--------|------|-----|--------------------------------------|---|--|-------------------|
|  |                        |  | LF  | LPR | LS | DCON | DCONMS | KAPR | DCN |                                      |   |  | DCX               |
| SET-06X30-ABHF-D06X30-WA25                         | ●                      | 06-30  | 85  | 45  | 56 | 25   | 55     | 95°  | 6   | 10                                   | SWLCR-D06X10-22                           | WCGT020104L  | ABHF-D06X30-WA25  |
|  |                        |  |   |     |    |      |        |      | 8   | 14                                   | SWLCR-D08X14-30                           |  |                   |
|  |                        |  |   |     |    |      |        |      | 12  | 18                                   | STUPR-D12X18-40                           |  |                   |
|  |                        |  |   |     |    |      |        |      | 16  | 22                                   | STUPR-D16X22-40                           |  |                   |
|  |                        |  |   |     |    |      |        |      | 20  | 26                                   | STUPR-D20X26-40                           |  |                   |
| SET-29X40-ABHF-D29X40-WA16                         | ●                      | 29-40  | 50  | 46  | 40 | 16   | 27     | 93°  | 24  | 30                                   | STUPR-D24X30-50                           | TPGX 090202L   | ABHF-D29X40-WA16  |
|  |                        |  |   |     |    |      |        |      | 29  | 35                                   | STFPR-D29x35                              |  |                   |
| SET-39X54-ABHF-D39X54-WA20                         | ●                      | 39-54  | 60  | 55  | 50 | 20   | 36     | 93°  | 34  | 40                                   | STFPR-D34x40                              | TPGX 090202L   | ABHF-D39X54-WA20  |
|  |                        |  |   |     |    |      |        |      | 39  | 47                                   | STFPR-D39x47                              |  |                   |
| SET-52X80-ABHF-D52X80-WA25                         | ●                      | 52-80  | 70  | 65  | 56 | 25   | 48     | 93°  | 46  | 54                                   | STFPR-D46x54                              | TPGX 090202L   | ABHF-D52X80-WA25  |
|  |                        |  |   |     |    |      |        |      | 52  | 68                                   | STFPR-D52x68                              |  |                   |
| SET-78X116-ABHF-D78X170-WA32                       | ●                      | 78-116   | 83  | 77  | 60 | 32   | 70     | 93°  | 64  | 80                                   | STFPR-D64x80                              | TPGX 090202L   | ABHF-D78X170-WA32 |
|  |                        |  |   |     |    |      |        |      | 78  | 98                                   | STFPR-D78x98                              |  |                   |
|  |                        |  |   |     |    |      |        |      | 96  | 116                                  | STFPR-D96x116                             |  |                   |

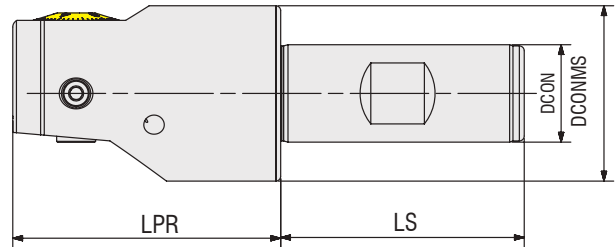

| Takım Kodu<br>Ordering Code<br>Bestell-Bezeichnung | Stok<br>Stock<br>Lager | Ölçü Aralığı<br>Boring Range<br>Bohrbereich<br>DCN-DCX | LPR | LS | DCON | DCONMS | Yedek Parçaları / Spare Parts / Ersatzteile     |            |
|--|------------------------|--|-----|----|------|--------|---|------------|
|  |                        |  |     |    |      |        | Anahtar<br>Allen Key<br>Innensechskantschlüssel |            |
| ABHF-D06X30-WA25                                   | ●                      | 06-30  | 45  | 56 | 25   | 55     | AAL-05-4  |            |
| ABHF-D29X40-WA16                                   | ●                      | 29-40  | 46  | 40 | 16   | 27     | AAL-01-2  | AAL-02-2.5 |
| ABHF-D39X54-WA20                                   | ●                      | 39-54  | 55  | 50 | 20   | 36     | AAL-02-2.5                                      | AAL-03-3   |
| ABHF-D52X80-WA25                                   | ●                      | 52-80  | 65  | 56 | 25   | 48     | AAL-05-4  | AAL-07-5   |
| ABHF-D78X170-WA32                                  | ●                      | 78-170   | 77  | 60 | 32   | 72     | AAL-07-5  | AAL-08-6   |

R: Sağ / Right / Rechts/ L: Sol / Left / Links

● Stokta / In Stock / Auf Lager ○ Stokta Yok / Non Stock Item / Kein Lagerartikel, Lieferzeit auf Anfrage

Siparişte, gövde ve kartuş set olarak verilecektir. / When ordered, body and cartridge will be sent as set.

Bei Bestellung werden Körper und Kassetten als Set geliefert.

Sipariş Örneği/Ordering Example/Bestellbeispiel

1 ad./pcs./stück SET-06X30-ABHF-D06X30-WA25

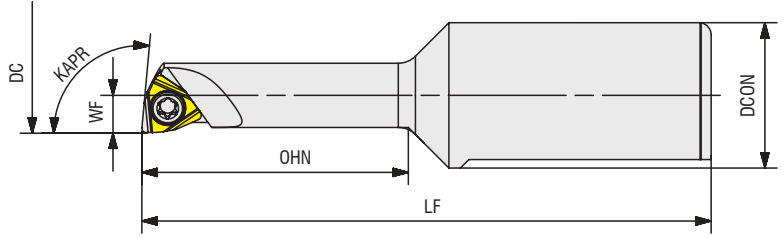

| Takım Kodu<br>Ordering Code<br>Bestell-Bezeichnung | Stok<br>Stock<br>Lager | Takım Ölçüleri (mm)<br>Dimension (mm)<br>Abmessung (mm) |    |      |    |     |      | Kesici Uç<br>Insert<br>Wendeschneidplatte | Yedek Parçaları / Spare Parts / Ersatzteile |  |
|--|------------------------|---|----|------|----|-----|------|---|---|--|
|  |                        | DCN   | WF | KAPR | LF | OHN | DCON |   | Sıkma Vidası<br>Screw<br>Schraube           | Tork Anahtar<br>Torx Key<br>Torx-Schlüssel |
| SWLCR-D06X10-22                                    | ●                      | 6   | 3  | 95°  | 47 | 22  | 12   | WCGT020104L                               | 3006-M2x3.3                                 | 82-T06                                     |
| SWLCR-D08X14-30                                    | ●                      | 8   | 4  |      | 55 | 30  |      |   |   |  |

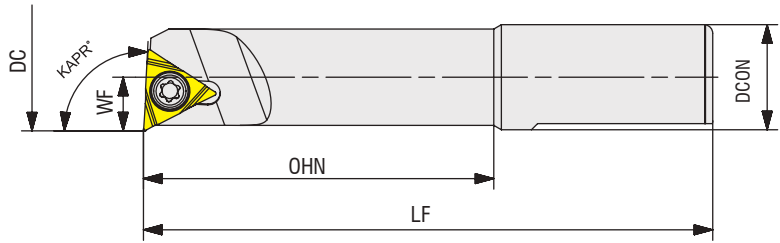

| Takım Kodu<br>Ordering Code<br>Bestell-Bezeichnung | Stok<br>Stock<br>Lager | Takım Ölçüleri (mm)<br>Dimension (mm)<br>Abmessung (mm) |    |      |    |     |      | Kesici Uç<br>Insert<br>Wendeschneidplatte | Yedek Parçaları / Spare Parts / Ersatzteile |  |    |    |  |
|--|------------------------|---|----|------|----|-----|------|---|---|--|----|----|--|
|  |                        | DCN   | WF | KAPR | LF | OHN | DCON |   | Sıkma Vidası<br>Screw<br>Schraube           | Tork Anahtar<br>Torx Key<br>Torx-Schlüssel |    |    |  |
| STUPR-D12X18-40                                    | ●                      | 12  | 6  | 93°  | 65 | 40  | 12   | TPGX 090202L                              | 4008-M2.5x4.5                               | 82-T08                                     |    |    |  |
| STUPR-D16X22-40                                    | ●                      | 16  | 8  |      |    |     |      |   |   |  |    |    |  |
| STUPR-D20X26-40                                    | ●                      | 20  | 10 |      |    |     |      |   |   |  |    |    |  |
| STUPR-D24X30-50                                    | ●                      | 24  | 12 |      |    |     |      |   |   |  | 75 | 50 |  |

● Stokta / In Stock / Auf Lager ○ Stokta Yok / Non Stock Item / Kein Lagerartikel, Lieferzeit auf Anfrage  
Siparişte, gövde ve kartuş set olarak verilecektir. / When ordered, body and cartridge will be sent as set.  
Bei Bestellung werden Körper und Kassetten als Set geliefert.

Sipariş Örneği/Ordering Example/Bestellbeispiel  
1 ad./pcs./stück SWLCR-D06X10-22

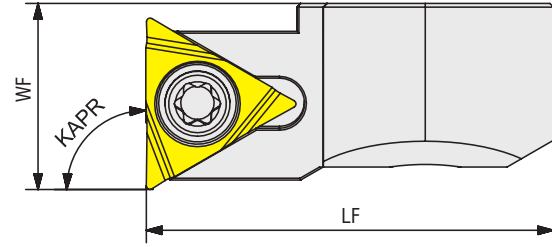

| Takım Kodu<br>Ordering Code<br>Bestell-Bezeichnung | Stok<br>Stock<br>Lager | Takım Ölçüleri (mm)<br>Dimension (mm)<br>Abmessung (mm) |      |       | Kesici Uç<br>Insert<br>Wendeschneidplatte | Yedek Parçaları / Spare Parts / Ersatzteile |  |
|--|------------------------|---|------|-------|---|---|--|
|  |                        | WF  | KAPR | LF    |   | Sıkma Vidası<br>Screw<br>Schraube           | Tork Anahtar<br>Torx Key<br>Torx-Schlüssel |
| STFPR-D29x35                                       | ●                      | 10  | 90°  | 21.90 | TPGX_090202L                              | 4008-M2.5x6                                 | 82-T08                                     |
| STFPR-D34x40                                       | ●                      | 12.50   |      | 21.90 |   |   |  |
| STFPR-D39x47                                       | ●                      | 12  |      | 26.90 |   |   |  |
| STFPR-D46x54                                       | ●                      | 15.50   |      | 26.90 |   |   |  |
| STFPR-D52x68                                       | ●                      | 14  |      | 34.90 |   |   |  |
| STFPR-D64x80                                       | ●                      | 20  |      | 34.90 |   |   |  |
| STFPR-D78x98                                       | ●                      | 20  |      | 44.90 |   |   |  |
| STFPR-D96x116                                      | ●                      | 29  |      | 44.90 |   |   |  |

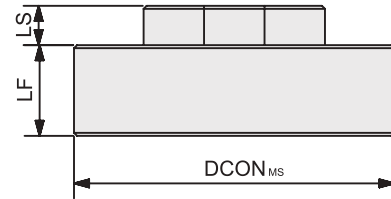

| Takım Kodu<br>Ordering Code<br>Bestell-Bezeichnung | Stok<br>Stock<br>Lager | Takım Ölçüleri (mm)<br>Dimension (mm)<br>Abmessung (mm) |       |    |
|--|------------------------|---|-------|----|
|  |                        | DCON  | LF    | LS |
| AEA-114x134  | ●                      | 31.80   | 12.90 | 9  |
| AEA-132x152  | ●                      | 31.80   | 21.90 | 18 |

● Stokta / In Stock / Auf Lager ○ Stokta Yok / Non Stock Item / Kein Lagerartikel, Lieferzeit auf Anfrage  
Siparişte, gövde ve kartuş set olarak verilecektir. / When ordered, body and cartridge will be sent as set.  
Bei Bestellung werden Körper und Kassetten als Set geliefert.

Sipariş Örneği/Ordering Example/Bestellbeispiel  
1 ad./pcs./stück STFPR-D29x35

Kartuşların Montajı / Assembling Boring Bar / Kartuschen Montage

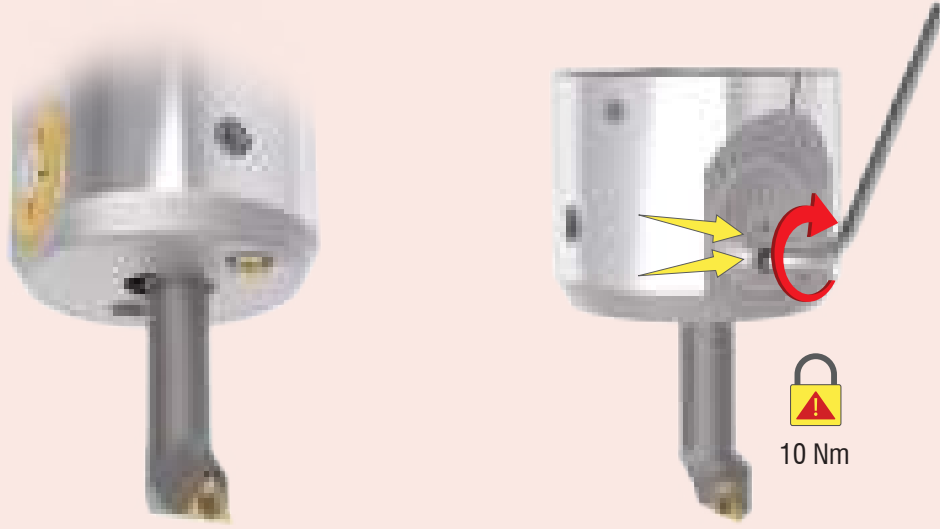

Çap Ayarı / Diameter Adjustment / Umfangeinstellung

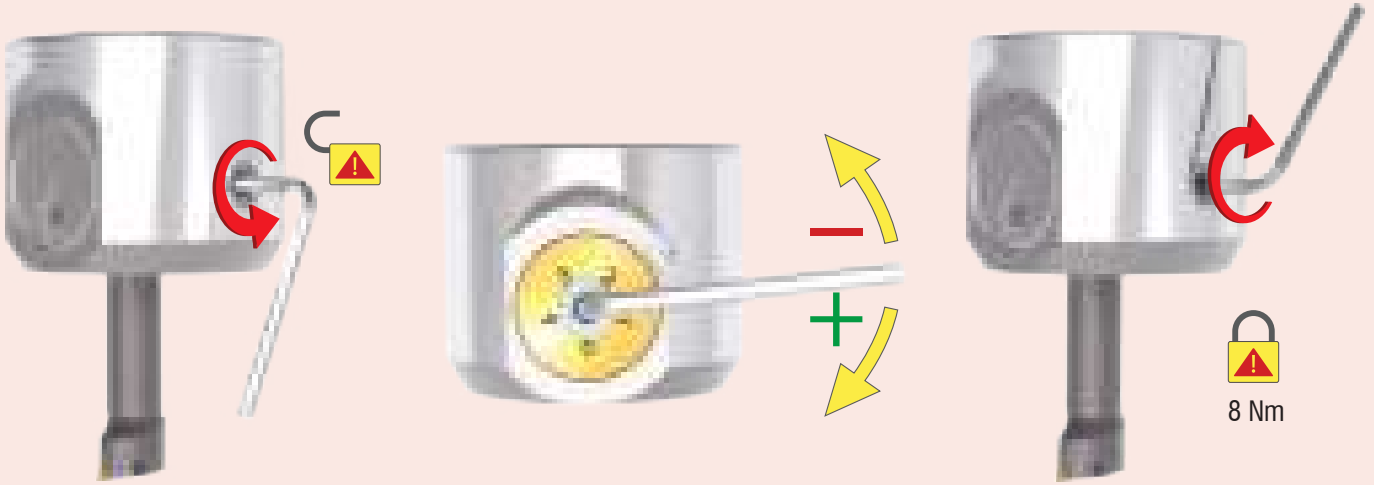

Ölçek / Scale - Vernier / Messparat

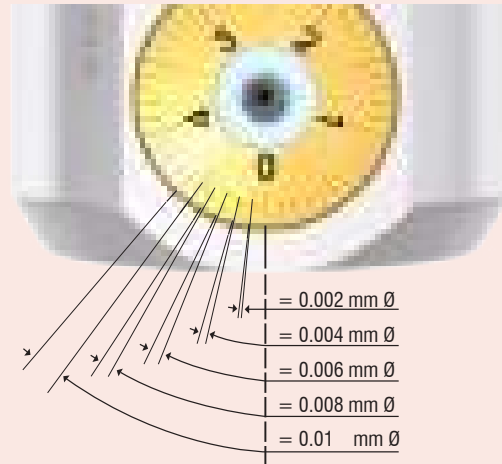
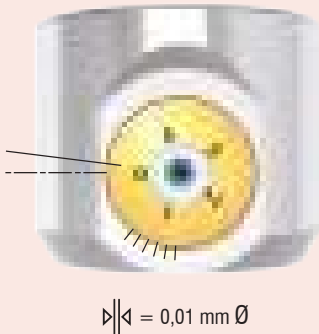

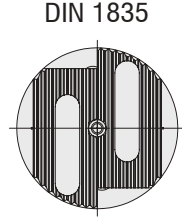
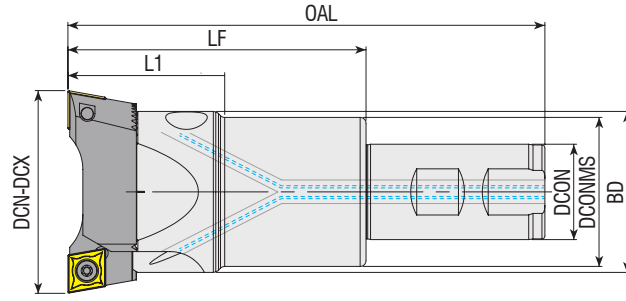

**Takım Kodu**  
**Ordering Code**  
**Bestell-Bezeichnung**

Stok  
Stock  
Lager

Takım Ölçüleri (mm)  
Dimension (mm)  
Abmessung (mm)

Kartuş  
Cartridge  
Kurzdrehhalter

Bara Gövde Takım Kodu  
Boring Head Body Code  
Trägerwerkzeug-Bezeichnung

|                               | Ölçü Aralığı<br>Boring Range<br>Durchmesser<br>DCN-DCX | DCN | DCNMS | BD | OAL | LF  | L1 |               |                        |
|-------------------------------|--|-----|-------|----|-----|-----|----|---------------|------------------------|
| ABHR-D18x22-W16-L90-CC06      | ● 18-22  | 16  | -     | -  | 90  | 42  | -  | AK.. 18-22    | ABHRS-D16x42-W16-L90   |
| ABHR-D18x22-W16-L150-CC06     | ● 18-22  | 16  | -     | -  | 150 | 102 | -  |               | ABHRS-D16x102-W16-L150 |
| ABHR-D18x22-W16-L200-CC06     | ● 18-22  | 16  | -     | -  | 200 | 152 | -  |               | ABHRS-D16x152-W16-L200 |
| ABHR-D22x28-W20-L100-CC06     | ● 22-28  | 20  | -     | -  | 100 | 50  | -  | AK.. 22-28    | ABHRS-D20x50-W20-L100  |
| ABHR-D22x28-W20-L150-CC06     | ● 22-28  | 20  | -     | -  | 150 | 100 | -  |               | ABHRS-D20x100-W20-L150 |
| ABHR-D22x28-W20-L200-CC06     | ● 22-28  | 20  | -     | -  | 200 | 150 | -  |               | ABHRS-D20x150-W20-L200 |
| ABHR-D28x38-W20-L110-CC06     | ● 28-38  | 20  | 25    | -  | 110 | 60  | -  | AK.. 28-38    | ABHRS-D25x60-W20-L110  |
| ABHR-D28x38-W20-L160-CC06     | ● 28-38  | 20  | 25    | -  | 160 | 110 | -  |               | ABHRS-D25x110-W20-L160 |
| ABHR-D28x38-W20-L230-CC06     | ● 28-38  | 20  | 25    | -  | 230 | 180 | -  |               | ABHRS-D25x180-W20-L230 |
| ABHR-D36x50-W25-L120-CC06     | ● 36-50  | 25  | 32    | -  | 120 | 64  | -  | AK.. 36-50    | ABHRS-D32x64-W25-L120  |
| ABHR-D36x50-W25-L170-CC06     | ● 36-50  | 25  | 32    | -  | 170 | 114 | -  |               | ABHRS-D32x114-W25-L170 |
| ABHR-D36x50-W25-L250-CC06     | ● 36-50  | 25  | 32    | -  | 250 | 194 | -  |               | ABHRS-D32x194-W25-L250 |
| ABHR-D36x50-W25-L120-CC09     | ● 36-50  | 25  | 32    | -  | 120 | 64  | -  | AK.. 36-50-09 | ABHRS-D32x64-W25-L120  |
| ABHR-D36x50-W25-L170-CC09     | ● 36-50  | 25  | 32    | -  | 170 | 114 | -  |               | ABHRS-D32x114-W25-L170 |
| ABHR-D36x50-W25-L250-CC09     | ● 36-50  | 25  | 32    | -  | 250 | 194 | -  |               | ABHRS-D32x194-W25-L250 |
| ABHR-D50x68-W32-L140-CC09     | ● 50-68  | 32  | 40    | -  | 140 | 80  | -  | AK.. 50-68    | ABHRS-D40x80-W32-L140  |
| ABHR-D50x68-W32-L200-CC09     | ● 50-68  | 32  | 40    | -  | 200 | 140 | -  |               | ABHRS-D40x140-W32-L200 |
| ABHR-D50x68-W32-L280-CC09     | ● 50-68  | 32  | 40    | -  | 280 | 220 | -  |               | ABHRS-D40x220-W32-L280 |
| ABHR-D50x68-W32-L140-CC12     | ● 50-68  | 32  | 40    | -  | 140 | 80  | -  | AK.. 50-68-12 | ABHRS-D40x80-W32-L140  |
| ABHR-D50x68-W32-L200-CC12     | ● 50-68  | 32  | 40    | -  | 200 | 140 | -  |               | ABHRS-D40x140-W32-L200 |
| ABHR-D50x68-W32-L280-CC12     | ● 50-68  | 32  | 40    | -  | 280 | 220 | -  |               | ABHRS-D40x220-W32-L280 |
| ABHR-D68x90-W32-L160-CC12     | ● 68-90  | 32  | 50    | 54 | 160 | 100 | 50 | AK.. 68-90    | ABHRS-D50x100-W32-L160 |
| ABHR-D68x90-W32-L210-CC12     | ● 68-90  | 32  | 50    | 54 | 210 | 150 | 50 |               | ABHRS-D50x150-W32-L210 |
| ABHR-D68x90-W32-L280-CC12     | ● 68-90  | 32  | 50    | 54 | 280 | 220 | 50 |               | ABHRS-D50x220-W32-L280 |
| ABHR-D90x120-W32-L140-CC12    | ● 90-120   | 32  | 63    | 72 | 140 | 80  | 63 | AK.. 90-120   | ABHRS-D63x80-W32-L140  |
| ABHR-D90x120-W40-L200-CC12    | ● 90-120   | 40  | 63    | 72 | 200 | 130 | 63 |               | ABHRS-D63x130-W40-L200 |
| ABHR-D90x120-W40-L300-CC12    | ● 90-120   | 40  | 63    | 72 | 300 | 230 | 63 |               | ABHRS-D63x230-W40-L300 |
| ABHR-D120x160-W40-L210-CC12   | ● 120-160  | 40  | 80    | 95 | 210 | 140 | 75 | AK.. 120-160  | ABHRS-D80x140-W40-L210 |
| ABHR-D120x160-W40-L300-CC12   | ● 120-160  | 40  | 80    | 95 | 300 | 230 | 75 |               | ABHRS-D80x230-W40-L300 |
| ABHR-D160x200-W40-L210-B-CC12 | ● 160-200  | 40  | 80    | 95 | 210 | 140 | 75 | AK.. 160-800  | ABHRS-D80x140-W40-L210 |
| ABHR-D160x200-W40-L300-B-CC12 | ● 160-200  | 40  | 80    | 95 | 300 | 230 | 75 |               | ABHRS-D80x230-W40-L300 |

R: Sağ / Right / Rechtsl L: Sol / Left / Links

● Stokta / In Stock / Auf Lager ○ Stokta Yok / Non Stock Item / Kein Lagerartikel, Lieferzeit auf Anfrage  
Siparişte, gövde ve kartuş set olarak verilecektir. / When ordered, body and cartridge will be sent as set.  
Bei Bestellung werden Körper und Kassetten als Set geliefert.

Sipariş Örneği/Ordering Example/Bestellbeispiel  
1 ad./pcs./stück ABHR-D18x22-W16-L90-CC06

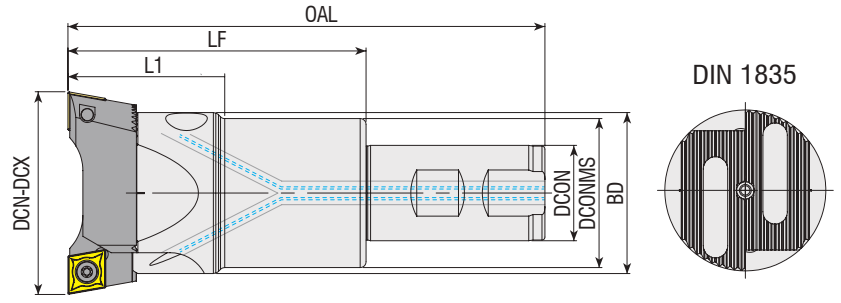

DIN 1835

Yedek Parçaları / Spare Parts / Ersatzteile

| Takım Kodu<br>Ordering Code<br>Bestell-Bezeichnung | Stok<br>Stock<br>Lager | Ölçü Aralığı<br>Boring Range<br>Durchmesser<br>DCN-DCX | Takım Ölçüleri (mm)<br>Dimension (mm)<br>Abmessung (mm) |        |    |     |     | Yedek Parçaları / Spare Parts / Ersatzteile |   |   |                                |  |   |
|--|------------------------|--|---|--------|----|-----|-----|---|---|---|--------------------------------|--|---|
|  |                        |  | DCON  | DCONMS | BD | OAL | LF  | L1  | Montaj Vidası<br>Mounting Screw<br>Befestigungsschraube | Montaj Vida Anahtarı<br>Mounting Screw Key<br>Innenschlüssel für Bolzen | Pabuç<br>Clamp<br>Spannspratze | Ayar Vidası<br>Adjusting Screw<br>Einstellschraube | Ayar Vida Anahtarı<br>Allen Key<br>Innenschlüssel-Schlüssel |
| ABHRS-D16x42-W16-L90                               | ●                      | 18-22  | 16  | -      | -  | 90  | 42  | -   |   |   |                                |  |   |
| ABHRS-D16x102-W16-L150                             | ●                      | 18-22  | 16  | -      | -  | 150 | 102 | -   | 2525-M3x14  | AAL-02-2.5  | ABKS-D16                       | 2715-M3x4  |   |
| ABHRS-D16x152-W16-L200                             | ●                      | 18-22  | 16  | -      | -  | 200 | 152 | -   |   |   |                                |  |   |
| ABHRS-D20x50-W20-L100                              | ●                      | 22-28  | 20  | -      | -  | 100 | 50  | -   |   |   |                                |  |   |
| ABHRS-D20x100-W20-L150                             | ●                      | 22-28  | 20  | -      | -  | 150 | 100 | -   | 2503-M4x15  | AAL-03-3  | ABKS-D20                       | 2715-M3x5  | AAL-09-1.5  |
| ABHRS-D20x150-W20-L200                             | ●                      | 22-28  | 20  | -      | -  | 200 | 150 | -   |   |   |                                |  |   |
| ABHRS-D25x60-W20-L110                              | ●                      | 28-38  | 20  | 25     | -  | 110 | 60  | -   |   |   |                                |  |   |
| ABHRS-D25x110-W20-L160                             | ●                      | 28-38  | 20  | 25     | -  | 160 | 110 | -   | 2503-M4x20  | AAL-03-3  | ABKS-D25                       | 2715-M3x8  |   |
| ABHRS-D25x180-W20-L230                             | ●                      | 28-38  | 20  | 25     | -  | 230 | 180 | -   |   |   |                                |  |   |
| ABHRS-D32X64-W25-L120                              | ●                      | 36-50  | 25  | 32     | -  | 120 | 64  | -   |   |   |                                |  |   |
| ABHRS-D32X114-W25-L170                             | ●                      | 36-50  | 25  | 32     | -  | 170 | 114 | -   | 2504-M5x25  | AAL-05-4  | ABKS-D32                       | 2702-M4x12   | AAL-01-2  |
| ABHRS-D32X194-W25-L250                             | ●                      | 36-50  | 25  | 32     | -  | 250 | 194 | -   |   |   |                                |  |   |
| ABHRS-D40x80-W32-L140                              | ●                      | 50-68  | 32  | 40     | -  | 140 | 80  | -   |   |   |                                |  |   |
| ABHRS-D40x140-W32-L200                             | ●                      | 50-68  | 32  | 40     | -  | 200 | 140 | -   | 2505-M6x30  | AAL-07-5  | ABKS-D40                       | 2725-M5x16   |   |
| ABHRS-D40x220-W32-L280                             | ●                      | 50-68  | 32  | 40     | -  | 280 | 220 | -   |   |   |                                |  | AAL-02-2.5  |
| ABHRS-D50x100-W32-L160                             | ●                      | 68-90  | 32  | 50     | 54 | 160 | 100 | 50  |   |   |                                |  |   |
| ABHRS-D50x150-W32-L210                             | ●                      | 68-90  | 32  | 50     | 54 | 210 | 150 | 50  | 2506-M8x35  | AAL-08-6  | ABKS-D50                       | 2725-M5x12   |   |
| ABHRS-D50x220-W32-L280                             | ●                      | 68-90  | 32  | 50     | 54 | 280 | 220 | 50  |   |   |                                |  |   |
| ABHRS-D63x80-W32-L140                              | ●                      | 90-120   | 32  | 63     | 72 | 140 | 80  | 63  |   |   |                                |  |   |
| ABHRS-D63x130-W40-L200                             | ●                      | 90-120   | 40  | 63     | 72 | 200 | 130 | 63  | 2508-M10x40   | AAL-11-8  | ABKS-D63                       | 2703-M6x16   | AAL-03-3  |
| ABHRS-D63x230-W40-L300                             | ●                      | 90-120   | 40  | 63     | 72 | 300 | 230 | 63  |   |   |                                |  |   |
| ABHRS-D80x140-W40-L210                             | ●                      | 120-160  | 40  | 80     | 95 | 210 | 140 | 75  | 2510-M12x40   |   |                                |  |   |
| ABHRS-D80x230-W40-L300                             | ●                      | 120-160  | 40  | 80     | 95 | 300 | 230 | 75  |   | AAL-12-10   | ABKS-D80                       | 2704-M8x25   | AAL-05-4  |
| ABHRS-D80x140-W40-L210                             | ●                      | 160-200  | 40  | 80     | 95 | 210 | 140 | 75  | 2510-M12x40   |   |                                |  |   |
| ABHRS-D80x230-W40-L300                             | ●                      | 160-200  | 40  | 80     | 95 | 300 | 230 | 75  |   |   |                                |  |   |

R: Sağ / Right / Rechts/ L: Sol / Left / Links

● Stokta / In Stock / Auf Lager ○ Stokta Yok / Non Stock Item / Kein Lagerartikel, Lieferzeit auf Anfrage

Sipariş Örneği/Ordering Example/Bestellbeispiel

1 ad./pcs./stück ABHRS-D16x42-W16-L90



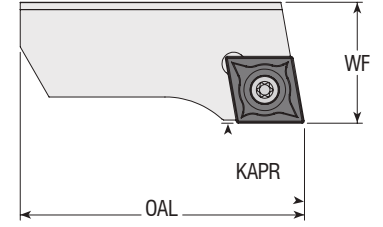

| Takım Kodu<br>Ordering Code<br>Bestell-Bezeichnung | Stok<br>Stock<br>Lager | Takım Ölçüleri (mm)<br>Dimension (mm)<br>Abmessung (mm) |    |     | Kesici Uç<br>Insert<br>Wendeschneidplatte | Yedek Parçaları / Spare Parts / Ersatzteile |  |  |
|--|------------------------|---|----|-----|---|---|--|--|
|  |                        | Ölçü Aralığı<br>Boring Range                            | WF | OAL |   | Sıkma Vidası<br>Screw<br>Schraube           | Tork Anahtar<br>Torx Key<br>Torx-Schlüssel |  |
|  |                        |   |    |     |   |   |  |  |
| AKSR 18-22   | ●                      | 18-22   | 9  | 15  | CC.T 0602..                               | 4008-M2.5x6                                 | 82-T08                                     |  |
| AKSR 22-28   | ●                      | 22-28   | 10 | 19  |   |   |  |  |
| AKSR 28-38   | ●                      | 28-38   | 13 | 23  |   |   |  |  |
| AKSR 36-50   | ●                      | 36-50   | 16 | 32  | CC.T 09T3..                               | 4015-M3.5x8                                 | 80-T15                                     |  |
| AKSR 36-50-09                                      | ●                      | 36-50   | 16 | 32  |   |   |  |  |
| AKSR 50-68   | ●                      | 50-68   | 20 | 40  |   |   |  |  |
| AKSR 50-68-12                                      | ●                      | 50-68   | 20 | 40  | CC.T 1204..                               | 1020-M5x11                                  | 80-T20                                     |  |
| AKSR 68-90   | ●                      | 68-90   | 23 | 54  |   |   |  |  |
| AKSR 90-120  | ●                      | 90-120  | 28 | 70  |   |   |  |  |
| AKSR 120-160                                       | ●                      | 120-160   | 32 | 95  |   |   |  |  |
| AKSR 160-200                                       | ●                      | 160-200   | 32 | 120 |   |   |  |  |

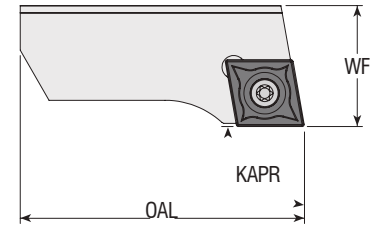

| Takım Kodu<br>Ordering Code<br>Bestell-Bezeichnung | Stok<br>Stock<br>Lager | Takım Ölçüleri (mm)<br>Dimension (mm)<br>Abmessung (mm) |      |     | Kesici Uç<br>Insert<br>Wendeschneidplatte | Yedek Parçaları / Spare Parts / Ersatzteile |  |  |
|--|------------------------|---|------|-----|---|---|--|--|
|  |                        | Ölçü Aralığı<br>Boring Range                            | WF   | OAL |   | Sıkma Vidası<br>Screw<br>Schraube           | Tork Anahtar<br>Torx Key<br>Torx-Schlüssel |  |
|  |                        |   |      |     |   |   |  |  |
| AKCR 28-38   | ●                      | 28-38   | 12.8 | 23  | CC.T 0602..                               | 4008-M2.5x6                                 | 82-T08                                     |  |
| AKCR 36-50   | ●                      | 36-50   | 15.8 | 32  |   |   |  |  |
| AKCR 36-50-09                                      | ●                      | 36-50   | 15.8 | 32  |   |   |  |  |
| AKCR 50-68   | ●                      | 50-68   | 19.7 | 40  | CC.T 09T3..                               | 4015-M3.5x8                                 | 80-T15                                     |  |
| AKCR 50-68-12                                      | ●                      | 50-68   | 19.7 | 40  |   |   |  |  |
| AKCR 68-90   | ●                      | 68-90   | 22.7 | 54  |   |   |  |  |
| AKCR 90-120  | ●                      | 90-120  | 27.7 | 70  | CC.T 1204..                               | 1020-M5x11                                  | 80-T20                                     |  |
| AKCR 120-160                                       | ●                      | 120-160   | 31.7 | 95  |   |   |  |  |
| AKCR 160-800                                       | ●                      | 160-800   | 31.7 | 120 |   |   |  |  |

R: Sağ / Right / Rechts/ L: Sol / Left / Links

● Stokta / In Stock / Auf Lager ○ Stokta Yok / Non Stock Item / Kein Lagerartikel, Lieferzeit auf Anfrage  
ISO Ucuna Uygunudur. / Compatible with ISO Insert. / Kompatibel mit ISO Wendeplatten.

Sipariş Örneği/Ordering Example/Bestellbeispiel  
1 ad./pcs./stück AKSR 18-22

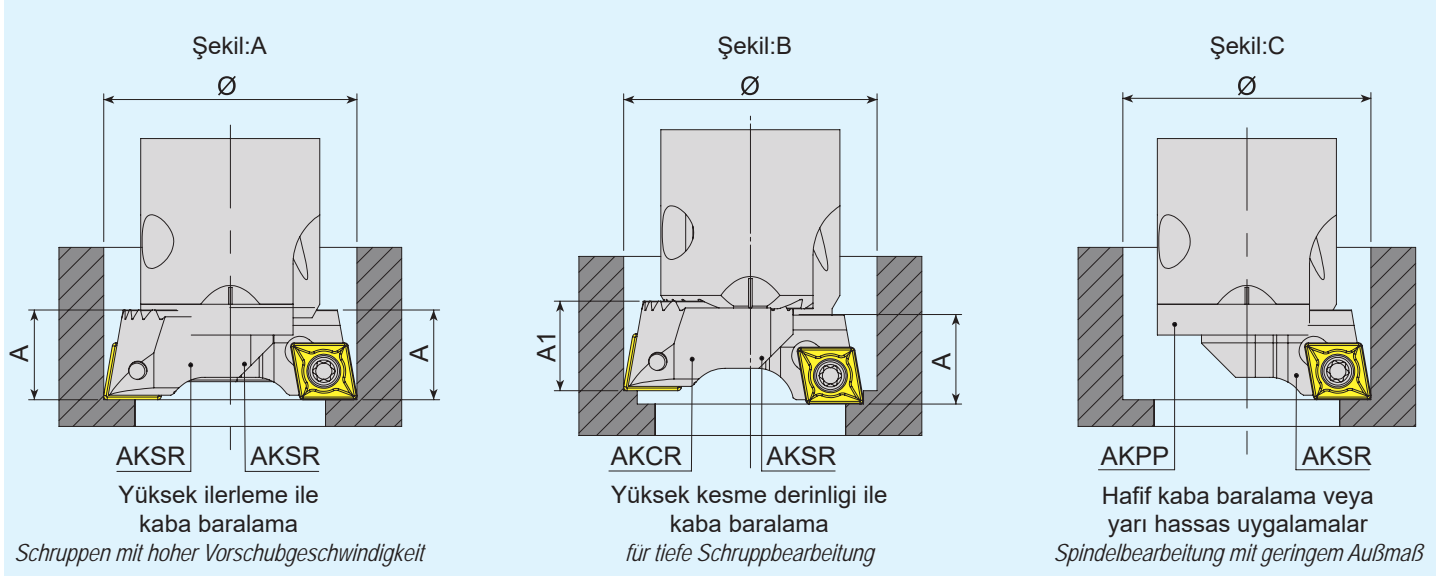

1. Kesici kenarların radyal ayarı, takım ölçme ekipmanı ile yapılmalıdır.
2. İki uçlu baralama takımı, ağır talaş kaldırma işlemini içeren kaba baralama işlemleri içindir.  
Çift uçlu baralama takımı ile:
  - Yüksek ilerleme oranında kaba baralama işlemleri için, aynı düzlemdeki iki AKSR kartuşu, aynı radyal mesafeye ayarlanır. (Şekil A)
  - Aynı düzlemde olmayan bir AKCR kartuşu ve bir AKSR kartuşu yüksek derinlikte kaba baralama işlemleri için kullanılır. (Şekil B)
    - i. Kaba baralama işleminde, alınacak paso miktarı tam olarak ikiye bölünüp, düzgün bir kesim sağlanmış olur, ancak bu durumda tur başına ilerleme tek ağız olarak hesaplanmalıdır. ( $f=f1$ )
    - ii. Hassas baralama işleminde, alınacak paso miktarı AKSR kartuş için ara kaba olarak ve AKCR kartuş için hassas bara olarak çaplar ayarlanır ve bu sayede bazı ara kaba işleme ihtiyacı kalmaz.
3. Tek kartuşlu baralama takımları, normal talaş kaldırma işlemini içeren kaba ve hassas baralama işlemleri içindir. Dişleri koruma plakası, AKPP daima kullanılmalıdır. (Şekil C)

1. Radial setting of the cutting edges should be carried out with tool presetting equipment.
2. Boring bars fitted with two insert pockets are for roughing operations involving heavy chip removal.  
The double-insert boring bars include:
  - Two AKSR cartridges on the same plane with two cutting edges set at identical radial distance for high feed rate roughing operations. (fig. A)
  - An AKCR cartridge and an AKSR cartridge not on the same plane for high-depth roughing operations. (fig. B)
    - i. With the rough boring operation, this allows double the cutting width, using only a single feed rate. ( $f=f1$ )
    - ii. With the finish boring operation, the cutting width is divided so that some of the intermediate machining can be omitted.
3. Boring bars fitted with a single cartridge are for roughing and finishing operations involving normal chip removal. The serrated surface protection plate AKPP should always be used (fig. C)

1. Die radiale Einstellung der Schneiden sollte auf einem Voreinstellgerät durchgeführt werden.
2. Spindelköpfe, die mit 2 Kassetten bestückt sind, werden für die Schrubbearbeitung eingesetzt.  
Doppelte Kassetten beinhalten:
  - Für die Schrubbearbeitung mit hoher Vorschubgeschwindigkeit sind zwei AKSR-Kassetten in derselben Höhe auf denselben radialen Abstand einzustellen ( Abbildung A )
  - Eine AKCR-Kassette und eine AKSR-Kassette, die nicht in derselben Ebene liegen, werden für tiefe Schrubbearbeitungen eingesetzt.
    - i. Bei einer Schrubbearbeitung kann die Schnitttiefe verdoppelt werden. Bitte nur eine Schneide zur Vorschubberechnung verwenden ( $f=f1$ ).
    - ii. Bei der Schlichtbearbeitung wird die Schnitttiefe halbiert. Weitere zusätzliche Bearbeitungsdurchgänge werden überflüssig.
3. Bohrköpfe mit einer einzelnen Kassette können sowohl für Schlicht- als auch für Schrubb-Operationen eingesetzt werden. Voraussetzung hierfür ist eine gute Spanabfuhr. Zum Schutz der verzahnten Oberfläche des Bohrkörpers sollte immer die Abdeckung AKPP verwendet werden (siehe Abb.C).



*konusulan  
the spoken kalite...  
quality...*

**FREZELEME TAKIMLARI**  
MILLING TOOLS  
FRÄSWERKZEUGE



AKKO **A** **EM** **90** **L** - **A** **P** **10**

1 2 3 4 5 6 7

**D12** - **W16** - **L100** - **Z01** - **H**

8 9 10 11 12

**2** Kesiş Stili / Cutter Style / Fräswerkzeug-Typ

FM: Yüzey Frezeleme Takımları / Face Milling Tools / Eck-und Planfräsköpfe  
EM: Alın ve Yüzey Parmak Frezeleri / End Face Milling Tools / Schafffräser  
CM: Pah Kırma Parmak Frezeleri / Chamfering End Milling Tools / Fasfräser  
HM: Helis Parmak Frezeleri / Helix End Milling Tools / Schafffräser Helix  
TSM: T Kanal Frezeleri / T Slot Milling Tools / T-Nutenfräser  
HFM: Yüksek İlerleme Frezeleme Takımları / High Feed Milling Tools / Fräser für hohe Vorschübe  
PMR: Küresel Uçlu Parmak Frezeleri / Ball Nose End Milling Tools / Kugel und Koperfräser  
SDM: Disk Frezeler / Slot Disc Milling / Scheibenfräser  
CBM: Silindirik Alyan Başlı Vida Havşalarını Açma Frezeleri / Countersink Milling Tool for Cylindrical Allen Head Screws  
Fräswerkzeug für zylindrische Inbusschrauben

**3** Freze Yanaşma Açısı / Lead Angle / Anstellwinkel

90° - 75° - 60° - 45°  
20° - 15° - 11° - 5° - 0°

**4** Freze Yanaşma Açısı / Lead Angle / Ausführung

L: Sol - Left / Links  
C: Baskı Pabuçu - Clamp / Spannpratze  
S: Altlık - Shim / Unterlage  
CL: Baskı Pabuçlu Sol Yön - Left Way with Clamp  
Spannspratze links  
CS: Baskı Pabuçlu Altlıklı - Clamp with Shim  
Spannspratze mit Unterlage  
CSL: Baskı Pabuçlu Altlıklı Sol Yön - Left Way Clamp with Shim  
Spannspratze mit Unterlage Links

**5** Uç Tipi / Type of Insert / Plattenform

|          |          |          |          |
|----------|----------|----------|----------|
|          |          |          |          |
| <b>C</b> | <b>D</b> | <b>E</b> | <b>K</b> |
|          |          |          |          |
| <b>L</b> | <b>R</b> | <b>S</b> | <b>T</b> |
|          |          |          |          |
| <b>V</b> | <b>W</b> | <b>A</b> | <b>B</b> |
|          |          |          |          |
| <b>H</b> | <b>M</b> | <b>O</b> | <b>P</b> |

**6** Serbest Uç Açısı / Clearance angle of Insert  
Freiwinkel der Wendeschneidplatte

|          |          |          |
|----------|----------|----------|
|          |          |          |
| <b>A</b> | <b>B</b> | <b>C</b> |
|          |          |          |
| <b>D</b> | <b>E</b> | <b>F</b> |
|          |          |          |
| <b>G</b> | <b>N</b> | <b>P</b> |

**7** Kesme Kenar Uzunluğu  
Cutting Edge Length  
Länge der Schneidkante

|          |          |
|----------|----------|
|          |          |
| <b>A</b> | <b>L</b> |
|          |          |
| <b>R</b> | <b>S</b> |
|          |          |
| <b>T</b> |          |

**8** Takım Çapı / Tool Diameter / Werkzeug-ø

**9** Montaj Formu ve Çapı / Assembly Form and Diameter / Schaft-ø und Form

A, B, C, D: ISO'ya göre montaj formu / Assembly Form and Diameter / Art der Montage und Durchmesser  
Silindirik Şaft / Cylindrical Shank / Zylindrischer Schaft  
W: Weldon

**10** Takım Boyu / Tool Length / Werkzeug Länge

**11** Etkili Diş Adedi / Number of Effective Tooth / Effektive Zähnezahl

**12** İçten Soğutmalı / With Coolant Hole / Innenkühlung

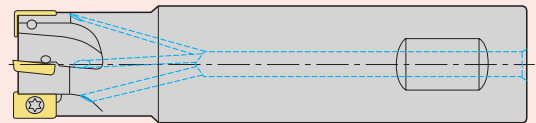

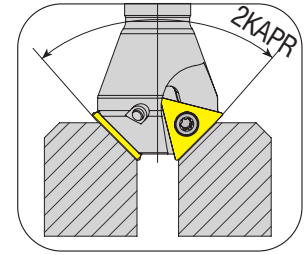
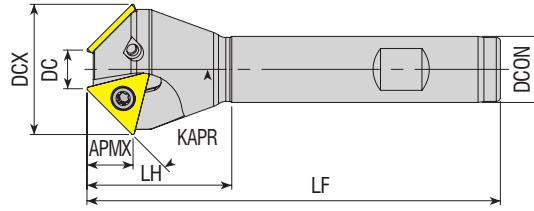

**Takım Kodu**  
**Ordering Code**  
*Bestell-Bezeichnung*

Stok  
Stock  
Lager

Takım Ölçüleri (mm)  
Dimension (mm)  
Abmessung (mm)

Kesici Uç  
Insert  
Wendeschneidplatte

Yedek Parçaları / Spare Parts / Ersatzteile

Sıkma Vidası  
Screw  
Schraube

Tork Anahtar  
Torx Key  
Torx-Schlüssel

KAPR DC DCX DCON LF LH ZEFP APMX



|   |   |       |      |      |    |     |    |   |      |             |               |        |             |
|---|---|-------|------|------|----|-----|----|---|------|-------------|---------------|--------|-------------|
| ACM10-TC16-D17X22-W16-L90-Z01             | ● | 10°   | 17   | 22   | 16 | 90  | 30 | 1 | 15.2 | TC.T 16T304 | 4015-M3.5x9   | 80-T15 |             |
| ACM15-TC16-D17X24-W16-L90-Z01             | ● | 15°   | 17   | 24   | 16 | 90  | 30 | 1 | 14.9 |             |               |        |             |
| ACM15-TC16-D22X29-W16-L100-Z01            | ● | 15°   | 22   | 29   | 16 | 100 | 30 | 1 | 14.9 |             |               |        |             |
| ACM15-TC16-D30X37-W20-L100-Z02            | ● | 15°   | 30   | 37   | 20 | 100 | 35 | 2 | 14.9 |             |               |        |             |
| ACM15-TC16-D35X42-W20-L100-Z03            | ● | 15°   | 35   | 42   | 20 | 100 | 38 | 3 | 14.9 |             |               |        |             |
| ACM15-TC16-D52X59-W25-L110-Z03            | ● | 15°   | 52   | 59   | 25 | 110 | 40 | 3 | 14.9 |             |               |        |             |
| ACM17.5-TC16-D17X25-W16-L90-Z01           | ● | 17.5° | 17   | 25   | 16 | 90  | 30 | 1 | 14.7 |             |               |        |             |
| ACM18.5-TC16-D21.3X30-W20-L100-Z02        | ● | 18.5° | 21.3 | 30   | 20 | 100 | 30 | 2 | 13.5 |             |               |        | TC.T 16T308 |
| ACM20-TC16-D12X22-W16-L100-Z01            | ● | 20°   | 12   | 22   | 16 | 100 | 30 | 1 | 14.4 |             |               |        |             |
| ACM20-TC16-D17X27-W16-L100-Z01            | ● | 20°   | 17   | 27   | 16 | 100 | 30 | 1 | 14.4 |             |               |        |             |
| ACM20-TC16-D23X33-W20-L100-Z02            | ● | 20°   | 23   | 33   | 20 | 100 | 30 | 2 | 14.4 |             |               |        |             |
| ACM20-TC16-D28X38-W20-L100-Z02            | ● | 20°   | 28   | 38   | 20 | 100 | 35 | 2 | 14.4 |             |               |        |             |
| ACM20-TC16-D35X45-W20-L100-Z03            | ● | 20°   | 35   | 45   | 20 | 100 | 40 | 3 | 14.4 |             |               |        |             |
| ACM20-TC16-D39X49-W20-L100-Z03            | ● | 20°   | 39   | 49   | 20 | 100 | 40 | 3 | 14.4 |             |               |        |             |
| ACM20-TC16-D45X55-W25-L110-Z03            | ● | 20°   | 45   | 55   | 25 | 110 | 40 | 3 | 14.4 |             |               |        |             |
| ACM20-TC16-D51X61-W25-L110-Z03            | ● | 20°   | 51   | 61   | 25 | 110 | 40 | 3 | 14.4 |             |               |        |             |
| ACM22.5-TC16-D17X28-W16-L100-Z01          | ● | 22.5° | 17   | 28   | 16 | 100 | 30 | 1 | 14.2 |             |               |        |             |
| ACM25-TC16-D17X29-W16-L100-Z01            | ● | 25°   | 17   | 29   | 16 | 100 | 30 | 1 | 13.9 |             |               |        |             |
| ACM30-TC16-D6X20-W16-L100-Z01             | ● | 30°   | 6    | 20   | 16 | 100 | 30 | 1 | 13.3 |             |               |        |             |
| ACM30-TC16-D15X30-W16-L100-Z01            | ● | 30°   | 15   | 30   | 16 | 100 | 30 | 1 | 13.3 |             |               |        |             |
| ACM30-TC16-D17.5X32.5-W20-L100-Z02        | ● | 30°   | 17.5 | 32.5 | 20 | 100 | 30 | 2 | 13.3 |             |               |        |             |
| ACM30-TC16-D20X35-W16-L100-Z02            | ● | 30°   | 20   | 35   | 16 | 100 | 35 | 2 | 13.3 |             |               |        |             |
| ACM30-TC16-D30X45-W20-L100-Z02            | ● | 30°   | 30   | 45   | 20 | 100 | 40 | 2 | 13.3 |             |               |        |             |
| ACM30-TC16-D35X50-W20-L100-Z03            | ● | 30°   | 35   | 50   | 20 | 100 | 40 | 3 | 13.3 |             |               |        |             |
| ACM30-TC16-D45X60-W25-L110-Z03            | ● | 30°   | 45   | 60   | 25 | 110 | 40 | 3 | 13.3 |             |               |        |             |
| <b>new</b> ACM40-TC16-D18x37-W20-L100-Z02 | ● | 40°   | 18   | 37   | 20 | 100 | 40 | 2 | 11.7 |             |               |        |             |
| ACM45-TC09-D7X18-W16-L100-Z02             | ● | 45°   | 7    | 18   | 16 | 100 | 25 | 2 | 5.9  | TC.T 090204 | 3007-M2.2x4.6 | 82-T07 |             |
| ACM45-TC11-D11X24-W16-L100-Z02            | ● | 45°   | 11   | 24   | 16 | 100 | 25 | 2 | 6.9  | TC.T 110204 | 3008-M2.5x6   | 82-T08 |             |
| ACM45-TC16-D5X26-W16-L100-Z01             | ● | 45°   | 5    | 26   | 16 | 100 | 30 | 1 | 10.8 |             |               |        |             |
| ACM45-TC16-D10X31-W16-L100-Z02            | ● | 45°   | 10   | 31   | 16 | 100 | 35 | 2 | 10.8 |             |               |        |             |
| ACM45-TC16-D10X31-W20-L100-Z02            | ● | 45°   | 10   | 31   | 20 | 100 | 35 | 2 | 10.8 |             |               |        |             |
| ACM45-TC16-D18X39-W16-L100-Z02            | ● | 45°   | 18   | 39   | 16 | 100 | 40 | 2 | 10.8 |             |               |        |             |
| ACM45-TC16-D18X39-W20-L100-Z02            | ● | 45°   | 18   | 39   | 20 | 100 | 40 | 2 | 10.8 |             |               |        |             |
| ACM45-TC16-D20X41-W20-L100-Z02            | ● | 45°   | 20   | 41   | 20 | 100 | 40 | 2 | 10.8 |             |               |        |             |
| ACM45-TC16-D30X51-W20-L100-Z02            | ● | 45°   | 30   | 51   | 20 | 100 | 40 | 2 | 10.8 |             |               |        |             |
| <b>new</b> ACM50-TC16-D16X39-W20-L100-Z03 | ● | 50°   | 16   | 39   | 20 | 100 | 40 | 3 | 9.8  |             |               |        |             |
| ACM55-TC16-D16X40-W20-L100-Z03            | ● | 55°   | 16   | 40   | 20 | 100 | 40 | 3 | 8.7  |             |               |        |             |
| ACM62-TC16-D14X40-W20-L100-Z03            | ● | 62°   | 14   | 40   | 20 | 100 | 40 | 3 | 7.1  |             |               |        |             |
| ACM72-TC16-D14X42-W20-L100-Z03            | ● | 72°   | 14   | 42   | 20 | 100 | 40 | 3 | 4.6  |             |               |        |             |

R: Sağ / Right / Rechts/ L: Sol / Left / Links

● Stokta / In Stock / Auf Lager ○ Stokta Yok / Non Stock Item / Kein Lagerartikel, Lieferzeit auf Anfrage

ISO Uçuna Uygundur. / Compatible with ISO Insert. / Kompatibel mit ISO Wendeplatten.

Sipariş Örneği/Ordering Example/Bestellbeispiel

1 ad./pcs./stück ACM10-TC16-D17X22-W16-L90-Z01

Kesme Hesabı : S 377/ Cutting Calculation : P 377 / Schnittberechnung : P 377



KAPR=45°

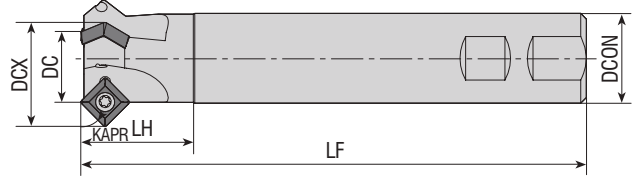

| Takım Kodu<br>Ordering Code<br>Bestell-Bezeichnung | Stok<br>Stock<br>Lager | Takım Ölçüleri (mm)<br>Dimension (mm)<br>Abmessung (mm) |    |     |      |     |    |      |   | Kesici Uç<br>Insert<br>Wendeschneidplatte | Yedek Parçaları / Spare Parts / Ersatzteile |  |
|--|------------------------|---|----|-----|------|-----|----|------|---|---|---|--|
|  |                        | KAPR  | DC | DCX | DCON | LF  | LH | ZEFP | a |   | Sıkma Vidası<br>Screw<br>Schraube           | Tork Anahtar<br>Torx Key<br>Torx-Schlüssel |
| ACM45-SP1104-D12x26-W20-L150-Z01                   | ●                      | 45°   | 12 | 26  | 20   | 150 | 30 | 1    | - | SPGT 110408                               | 4015-M4x9                                   | 80-T15                                     |
| ACM45-SP1104-D25x39-W25-L150-Z02                   | ●                      | 45°   | 25 | 39  | 25   | 150 | 35 | 2    | - |   |   |  |
| ACM45-SP1104-D32x46-W32-L150-Z03                   | ●                      | 45°   | 32 | 46  | 32   | 150 | 40 | 3    | - |   |   |  |

ZCC Ucuna Uygun. / Compatible with ZCC Insert. / Kompatibel mit ZCC Wendeplatten.

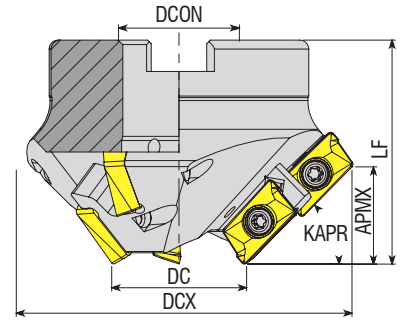

| Takım Kodu<br>Ordering Code<br>Bestell-Bezeichnung | Stok<br>Stock<br>Lager | Takım Ölçüleri (mm)<br>Dimension (mm)<br>Abmessung (mm) |                                 |      |    |     |      |      |    | Kesici Uç<br>Insert<br>Wendeschneidplatte | Yedek Parçaları / Spare Parts / Ersatzteile |  |
|--|------------------------|---|---------------------------------|------|----|-----|------|------|----|---|---|--|
|  |                        | ZEFP  |                                 | KAPR | DC | DCX | DCON | APMX | LF |   | Sıkma Vidası<br>Screw<br>Schraube           | Tork Anahtar<br>Torx Key<br>Torx-Schlüssel |
|  |                        | Toplam<br>Total<br>Gesamt                               | Etkili<br>Effective<br>Effektiv |      |    |     |      |      |    |   |   |  |
| AHM15-AP16-D35x93-A27-Z0306-H                      | ●                      | 6   | 3                               | 15   | 35 | 93  | 27   | 8    | 50 | AP. 1604..                                | 4015-M4x11                                  | 80-T15                                     |
| AHM30-AP16-D35x87-A27-Z0306-H                      | ●                      | 6   | 3                               | 30   | 35 | 87  | 27   | 15   | 50 |   |   |  |
| AHM45-AP16-D35x77-A27-Z0306-H                      | ●                      | 6   | 3                               | 45   | 35 | 77  | 27   | 21.5 | 50 |   |   |  |
| AHM60-AP16-D35x65-A22-Z0306-H                      | ●                      | 6   | 3                               | 60   | 35 | 65  | 22   | 26.5 | 50 |   |   |  |
| AHM75-AP16-D35x50-A22-Z0306-H                      | ●                      | 6   | 3                               | 75   | 35 | 50  | 22   | 29.5 | 50 |   |   |  |

R: Sağ / Right / Rechts/ L: Sol / Left / Links

● Stokta / In Stock / Auf Lager ○ Stokta Yok / Non Stock Item / Kein Lagerartikel, Lieferzeit auf Anfrage  
ISO Ucuna Uygun. / Compatible with ISO Insert. / Kompatibel mit ISO Wendeplatten.

Sipariş Örneği/Ordering Example/Bestellbeispiel

1 ad./pcs./stück ACM45-SP1104-D12x26-W20-L150-Z01

Kesme Hesabı : S 377/ Cutting Calculation : P 377 / Schnittberechnung : P 377

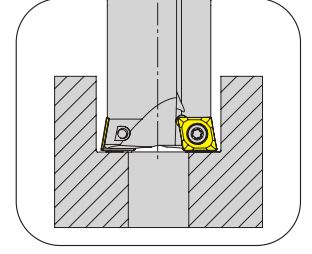
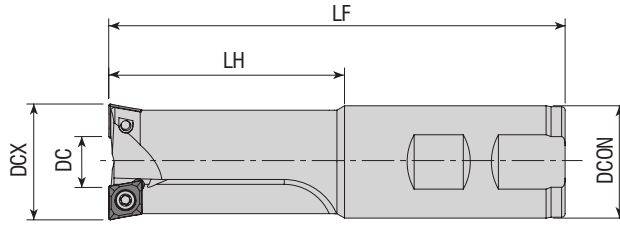

**Takım Kodu**  
**Ordering Code**  
*Bestell-Bezeichnung*

Stok  
 Stock  
 Lager

Takım Ölçüleri (mm)  
 Dimension (mm)  
 Abmessung (mm)

Kesici Uç  
 Insert  
 Wendeschneidplatte

Yedek Parçaları / Spare Parts / Ersatzteile

Sıkma Vidası  
 Screw  
 Schraube

Tork Anahtar  
 Torx Key  
 Torx-Schlüssel

DC DCX DCON LH LF

Kullanılan  
 Vidalar  
 For Screws  
 Für Schraube



|                                   |   |      |    |    |    |     |     |
|-----------------------------------|---|------|----|----|----|-----|-----|
| ACBM-CC06-D17X6-W16-L150-Z02      | ● | 6    | 17 | 16 | 30 | 150 | -   |
| ACBM-CC06-D18X7-W16-L100-Z02-H    | ● | 7    | 18 | 16 | 32 | 100 | M10 |
| ACBM-CC06-D18X7-W16-L160-Z02-H    | ● | 7    | 18 | 16 | 32 | 160 | M10 |
| ACBM-CC06-D20X9-W20-L100-Z02-H    | ● | 9    | 20 | 20 | 40 | 100 | M12 |
| ACBM-CC06-D20X9-W20-L160-Z02-H    | ● | 9    | 20 | 20 | 38 | 160 | M12 |
| ACBM-CC09-D26X8.5-W25-L130-Z02-H  | ● | 8.5  | 26 | 25 | 50 | 130 | M16 |
| ACBM-CC09-D26X8.5-W25-L200-Z02-H  | ● | 8.5  | 26 | 25 | 50 | 200 | M16 |
| ACBM-CC09-D30X12.5-W32-L130-Z02-H | ● | 12.5 | 30 | 32 | 65 | 130 | -   |
| ACBM-CC09-D33X15.5-W32-L130-Z02-H | ● | 15.5 | 33 | 32 | 65 | 130 | M20 |
| ACBM-CC09-D33X15.5-W32-L200-Z02-H | ● | 15.5 | 33 | 32 | 65 | 200 | M20 |
| ACBM-SP06-D15X4-W16-L160-Z02-H    | ● | 4    | 15 | 16 | 80 | 160 | M8  |

CC.. 060204

3008-M2.5x6

82-T08

CC.. 09T304

4015-M3.5x9

80-T15

SP. 060204

3007-M2.2x4.6

82-T07

R: Sağ / Right / Rechts! L: Sol / Left / Links

● Stokta / In Stock / Auf Lager ○ Stokta Yok / Non Stock Item / Kein Lagerartikel, Lieferzeit auf Anfrage  
 ISO Ucuna Uygundur. / Compatible with ISO Insert. / Kompatibel mit ISO Wendeplatten.

Sipariş Örneği/Ordering Example/Bestellbeispiel

1 ad./pcs./stück ACBM-CC06-D17X6-W16-L150-Z02

Kesme Hesabı : S 377/ Cutting Calculation : P 377 / Schnittberechnung : P 377



## S-SİSTEM YÜZEY PARMAK FREZELER

S-SYSTEM END MILLS

S-SYSTEM SCHAFTFRÄSER

KAPR=90°

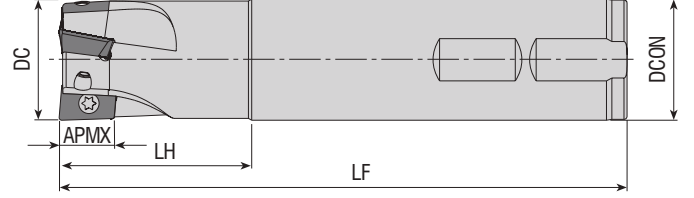

| Takım Kodu<br>Ordering Code<br>Bestell-Bezeichnung | Stok<br>Stock<br>Lager | Takım Ölçüleri (mm)<br>Dimension (mm)<br>Abmessung (mm) |      |      |     |    |       | Kesici Uç<br>Insert<br>Wendeschneidplatte | Yedek Parçaları / Spare Parts / Ersatzteile |  |                    |           |        |
|--|------------------------|---|------|------|-----|----|-------|---|---|--|--------------------|-----------|--------|
|  |                        | DC  | ZEFP | DCON | LF  | LH | APMX  |   | Sıkma Vidası<br>Screw<br>Schraube           | Tork Anahtar<br>Torx Key<br>Torx-Schlüssel |                    |           |        |
| AEM90-AD1505-D25-W25-L150-Z02                      | ●                      | 25  | 2    | 25   | 150 | 50 | 14.30 |   |   |  |                    |           |        |
| AEM90-AD1505-D30-W25-L150-Z03                      | ●                      | 30  | 3    | 25   | 150 | 40 | 14.30 |   |   |  | <b>AD.. 1505..</b> | 4015-M4x9 | 80-T15 |
| AEM90-AD1505-D32-W32-L150-Z03                      | ●                      | 32  | 3    | 32   | 150 | 50 | 14.30 |   |   |  |                    |           |        |

ISCR Ucuna Uygunur. / Compatible with ISCR Insert. / Kompatibel mit ISCR Wendepplatten.

KAPR=90°

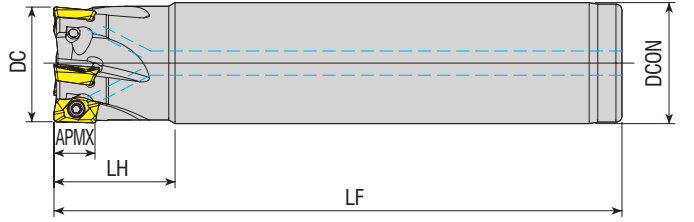

| Takım Kodu<br>Ordering Code<br>Bestell-Bezeichnung | Stok<br>Stock<br>Lager | Takım Ölçüleri (mm)<br>Dimension (mm)<br>Abmessung (mm) |      |      |     |    |      | Kesici Uç<br>Insert<br>Wendeschneidplatte | Yedek Parçaları / Spare Parts / Ersatzteile                           |  |
|--|------------------------|---|------|------|-----|----|------|---|---|--|
|  |                        | DC  | ZEFP | DCON | LF  | LH | APMX |   | Sıkma Vidası<br>Screw<br>Schraube                                     | Tork Anahtar<br>Torx Key<br>Torx-Schlüssel |
| AEM90-AD07-D10-C08-L90-Z02-H                       | ●                      | 10  | 2    | 8    | 90  | 16 | 6    |   |   |  |
| AEM90-AD07-D10-C10-L80-Z02-H                       | ●                      | 10  | 2    | 10   | 80  | 16 | 6    |   |   |  |
| AEM90-AD07-D12-C10-L80-Z03-H                       | ●                      | 12  | 3    | 10   | 80  | 18 | 6    |   |   |  |
| AEM90-AD07-D12-C12-L90-Z03-H                       | ●                      | 12  | 3    | 12   | 90  | 18 | 6    |   |   |  |
| AEM90-AD07-D16-C16-L110-Z04-H                      | ●                      | 16  | 4    | 16   | 110 | 19 | 6    |   |   |  |
| AEM90-AD07-D20-C20-L125-Z05-H                      | ●                      | 20  | 5    | 20   | 125 | 20 | 6    |   |   |  |
| AEM90-AD07-D25-C25-L140-Z06-H                      | ●                      | 25  | 6    | 25   | 140 | 24 | 6    | <b>ADMX 0702..</b>                        | 3006-M2x3.3<br>3006-M2x3.1<br>3006-M2x3.3<br>3006-M2x3.6<br>3006-M2x4 | 82-T06                                     |
| AEM90-AD11-D16-C16-L135-Z02-H                      | ●                      | 16  | 2    | 16   | 135 | 24 | 9    |   |   |  |
| AEM90-AD11-D18-C16-L135-Z02-H                      | ●                      | 18  | 2    | 16   | 135 | 15 | 9    |   |   |  |
| AEM90-AD11-D18-C16-L160-Z02-H                      | ●                      | 18  | 2    | 16   | 160 | 15 | 9    | <b>ADMX 11T3..</b>                        | 3008-M2.5x5<br>3008-M2.5x6  | 82-T08                                     |
| AEM90-AD11-D20-C20-L150-Z02-H                      | ●                      | 20  | 2    | 20   | 150 | 50 | 9    |   |   |  |
| AEM90-AD11-D20-C20-L150-Z03-H                      | ●                      | 20  | 3    | 20   | 150 | 50 | 9    |   |   |  |
| AEM90-AD11-D22-C20-L150-Z03-H                      | ●                      | 22  | 3    | 20   | 150 | 15 | 9    |   |   |  |
| AEM90-AD11-D22-C20-L200-Z03-H                      | ●                      | 22  | 3    | 20   | 200 | 15 | 9    |   |   |  |
| AEM90-AD11-D25-C25-L170-Z03-H                      | ●                      | 25  | 3    | 25   | 170 | 50 | 9    |   |   |  |
| AEM90-AD11-D25-C25-L170-Z04-H                      | ●                      | 25  | 4    | 25   | 170 | 50 | 9    |   |   |  |
| AEM90-AD11-D28-C25-L165-Z04-H                      | ●                      | 28  | 4    | 25   | 165 | 17 | 9    |   |   |  |
| AEM90-AD11-D28-C25-L200-Z04-H                      | ●                      | 28  | 4    | 25   | 200 | 17 | 9    |   |   |  |
| AEM90-AD11-D30-C25-L165-Z04-H                      | ●                      | 30  | 4    | 25   | 165 | 19 | 9    |   |   |  |
| AEM90-AD11-D30-C25-L200-Z04-H                      | ●                      | 30  | 4    | 25   | 200 | 19 | 9    |   |   |  |
| AEM90-AD11-D32-C32-L195-Z05-H                      | ●                      | 32  | 5    | 32   | 195 | 50 | 9    |   |   |  |

R: Sağ / Right / Rechts/ L: Sol / Left / Links

● Stokta / In Stock / Auf Lager ○ Stokta Yok / Non Stock Item / Kein Lagerartikel, Lieferzeit auf Anfrage

PRMT Ucuna Uygunur. / Compatible with PRMT Insert. / Kompatibel mit PRMT Wendepplatten.

Sipariş Örneği/Ordering Example/Bestellbeispiel

1 ad./pcs./stück AEM90-AD1505-D25-W25-L150-Z02

Kesme Hesabı : S 377/ Cutting Calculation : P 377 / Schnittberechnung : P 377



www.akkо.com.tr



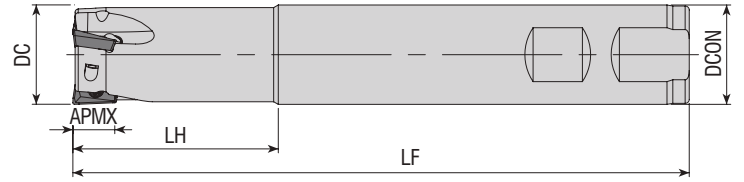

| Takım Kodu<br>Ordering Code<br>Bestell-Bezeichnung | Stok<br>Stock<br>Lager | Takım Ölçüleri (mm)<br>Dimension (mm)<br>Abmessung (mm) |      |      |     |    |      | Kesici Uç<br>Insert<br>Wendeschneidplatte | Yedek Parçaları / Spare Parts / Ersatzteile |  |  |
|--|------------------------|---|------|------|-----|----|------|---|---|--|--|
|  |                        | DC  | ZEPF | DCON | LF  | LH | APMX |   | Sıkma Vidası<br>Screw<br>Schraube           | Tork Anahtar<br>Torx Key<br>Torx-Schlüssel |  |
| AEM90-AD0803-D16-W16-L150-Z02                      | ●                      | 16  | 2    | 16   | 150 | 30 | 8    | ADMT 0803..                               | 3008-M2.5x5                                 |  |  |
| AEM90-AD0803-D17-W16-L150-Z02                      | ●                      | 17  | 2    | 16   | 150 | 30 | 8    |   |   |  |  |
| AEM90-AD0803-D17-W16-L200-Z02                      | ●                      | 17  | 2    | 16   | 200 | 30 | 8    |   |   |  |  |
| AEM90-AD0803-D20-W20-L150-Z03                      | ●                      | 20  | 3    | 20   | 150 | 30 | 8    |   |   |  |  |
| AEM90-AD0803-D21-W20-L200-Z03                      | ●                      | 21  | 3    | 20   | 200 | 30 | 8    |   |   |  |  |
| AEM90-AD10T3-D16-W16-L100-Z02-H                    | ●                      | 16  | 2    | 16   | 100 | 30 | 10   | ADMT 10T3..                               | 3008-M2.5x6                                 | 82-T08                                     |  |
| AEM90-AD10T3-D16-W16-L150-Z02                      | ●                      | 16  | 2    | 16   | 150 | 40 | 10   |   |   |  |  |
| AEM90-AD10T3-D16-C16-L200-Z02                      | ●                      | 16  | 2    | 16   | 200 | 50 | 10   |   |   |  |  |
| AEM90-AD10T3-D17-W16-L150-Z02                      | ●                      | 17  | 2    | 16   | 150 | 30 | 10   |   |   |  |  |
| AEM90-AD10T3-D17-W16-L200-Z02                      | ●                      | 17  | 2    | 16   | 200 | 30 | 10   |   |   |  |  |
| AEM90-AD10T3-D20-W20-L70-Z03                       | ●                      | 20  | 3    | 20   | 70  | 30 | 10   |   |   |  |  |
| AEM90-AD10T3-D20-W20-L100-Z03-H                    | ●                      | 20  | 3    | 20   | 100 | 30 | 10   |   |   |  |  |
| AEM90-AD10T3-D20-W20-L150-Z03                      | ●                      | 20  | 3    | 20   | 150 | 40 | 10   |   |   |  |  |
| AEM90-AD10T3-D20-C20-L150-Z03                      | ●                      | 20  | 3    | 20   | 150 | 40 | 10   |   |   |  |  |
| AEM90-AD10T3-D20-C20-L200-Z03                      | ●                      | 20  | 3    | 20   | 200 | 50 | 10   |   |   |  |  |
| AEM90-AD10T3-D25-W25-L100-Z03-H                    | ●                      | 25  | 3    | 25   | 100 | 30 | 10   | ADMT 1204..                               | 4010-M3x6                                   | 82-T10                                     |  |
| AEM90-AD10T3-D25-W25-L100-Z04-H                    | ●                      | 25  | 4    | 25   | 100 | 30 | 10   |   |   |  |  |
| AEM90-AD10T3-D25-W25-L150-Z03                      | ●                      | 25  | 3    | 25   | 150 | 50 | 10   |   |   |  |  |
| AEM90-AD1204-D20-W20-L150-Z02                      | ●                      | 20  | 2    | 20   | 150 | 50 | 12   |   |   |  |  |
| AEM90-AD1204-D21-C20-L150-Z02                      | ●                      | 21  | 2    | 20   | 150 | 30 | 12   |   |   |  |  |
| AEM90-AD1204-D22-C20-L150-Z02                      | ●                      | 22  | 2    | 20   | 150 | 30 | 12   | ADMT 1606..                               | 4015-M4x9                                   | 80-T15                                     |  |
| AEM90-AD1204-D25-W25-L150-Z03                      | ●                      | 25  | 3    | 25   | 150 | 50 | 12   |   |   |  |  |
| AEM90-AD1204-D26-W25-L180-Z03                      | ●                      | 26  | 3    | 25   | 180 | 30 | 12   |   |   |  |  |
| AEM90-AD1204-D32-W32-L150-Z04                      | ●                      | 32  | 4    | 32   | 150 | 50 | 12   | ADMT 1606..                               | 4015-M4x9                                   | 80-T15                                     |  |
| AEM90-AD1606-D25-W25-L150-Z02                      | ●                      | 25  | 2    | 25   | 150 | 50 | 15   |   |   |  |  |
| AEM90-AD1606-D32-W32-L150-Z03                      | ●                      | 32  | 3    | 32   | 150 | 50 | 15   |   |   |  |  |

R: Sağ / Right / Rechtsl L: Sol / Left / Links

● Stokta / In Stock / Auf Lager ○ Stokta Yok / Non Stock Item / Kein Lagerartikel, Lieferzeit auf Anfrage  
WLTR Ucuna Uygundur. / Compatible with WLTR Insert. / Kompatibel mit WLTR Wendeplatten.

Sipariş Örneği/Ordering Example/Bestellbeispiel

1 ad./pcs./stück AEM90-AD0803-D16-W16-L150-Z02

Kesme Hesabı : S 377 / Cutting Calculation : P 377 / Schnittberechnung : P 377

## S-SİSTEM YÜZEY PARMAK FREZELER

S-SYSTEM END MILLS

S-SYSTEM SCHAFTFRÄSER

KAPR=90°

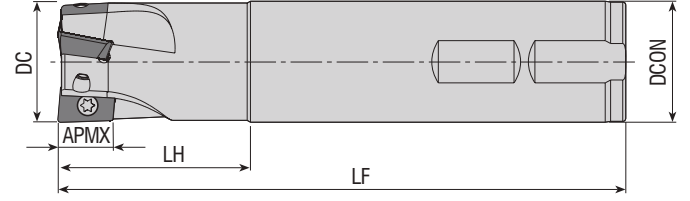

| Takım Kodu<br>Ordering Code<br>Bestell-Bezeichnung | Stok<br>Stock<br>Lager | Takım Ölçüleri (mm)<br>Dimension (mm)<br>Abmessung (mm) |      |      |     |    |      | Kesici Uç<br>Insert<br>Wendeschneidplatte | Yedek Parçaları / Spare Parts / Ersatzteile |  |
|--|------------------------|---|------|------|-----|----|------|---|---|--|
|  |                        | DC  | ZEFP | DCON | LF  | LH | APMX |   | Sıkma Vidası<br>Screw<br>Schraube           | Tork Anahtar<br>Torx Key<br>Torx-Schlüssel |
| AEM90-AD1003-D16-C16-L150-Z02                      | ●                      | 16  | 2    | 16   | 150 | 30 | 8    | ADMT 1003..                               | 3008-M2.5x5                                 | 82-T08                                     |
| AEM90-AD1003-D17-C16-L150-Z02                      | ●                      | 17  | 2    | 16   | 150 | 25 | 8    |   |   |  |
| AEM90-AD1003-D20-C20-L200-Z03                      | ●                      | 20  | 3    | 20   | 200 | 50 | 8    |   |   |  |
| AEM90-AD1003-D21-C20-L150-Z03                      | ●                      | 21  | 3    | 20   | 150 | 25 | 8    |   |   |  |
| AEM90-AD1003-D21-C20-L200-Z03                      | ●                      | 21  | 3    | 20   | 200 | 25 | 8    |   |   |  |
| AEM90-AD1003-D25-C25-L200-Z03                      | ●                      | 25  | 3    | 25   | 200 | 50 | 8    |   |   |  |
| AEM90-AD1003-D26-C25-L150-Z03                      | ●                      | 26  | 3    | 25   | 150 | 30 | 8    |   |   |  |
| AEM90-AD1003-D26-C25-L200-Z03                      | ●                      | 26  | 3    | 25   | 200 | 30 | 8    | ADKT 1505..                               | 4015-M4x9<br>4015-M4x11                     | 80-T15                                     |
| AEM90-AD1505D-D25-W25-L150-Z02                     | ●                      | 25  | 2    | 25   | 150 | 50 | 14.3 |   |   |  |
| AEM90-AD1505D-D32-W32-L150-Z03                     | ●                      | 32  | 3    | 32   | 150 | 50 | 14.3 |   |   |  |

DJT Ucuna Uygundur. / Compatible with DJT Insert. / Kompatibel mit DJT Wendeplatten.

KAPR=90°

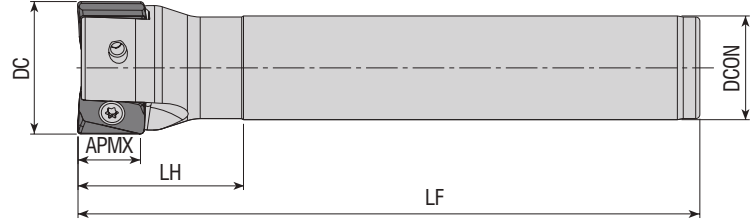

| Takım Kodu<br>Ordering Code<br>Bestell-Bezeichnung | Stok<br>Stock<br>Lager | Takım Ölçüleri (mm)<br>Dimension (mm)<br>Abmessung (mm) |      |      |     |    |      | Kesici Uç<br>Insert<br>Wendeschneidplatte | Yedek Parçaları / Spare Parts / Ersatzteile |  |
|--|------------------------|---|------|------|-----|----|------|---|---|--|
|  |                        | DC  | ZEFP | DCON | LF  | LH | APMX |   | Sıkma Vidası<br>Screw<br>Schraube           | Tork Anahtar<br>Torx Key<br>Torx-Schlüssel |
| AEM90-AN11-D22-W20-L150-Z02                        | ●                      | 22  | 2    | 20   | 150 | 30 | 11   | ANGX 1105..                               | 4010-M3x8                                   | 82-T10                                     |
| AEM90-AN11-D25-W25-L150-Z02                        | ●                      | 25  | 2    | 25   | 150 | 40 | 11   |   |   |  |
| AEM90-AN11-D25-C25-L200-Z02                        | ●                      | 25  | 2    | 25   | 200 | 40 | 11   |   |   |  |
| AEM90-AN11-D26-W25-L150-Z02                        | ●                      | 26  | 2    | 25   | 150 | 40 | 11   |   |   |  |
| AEM90-AN11-D28-W25-L150-Z02                        | ●                      | 28  | 2    | 25   | 150 | 25 | 11   |   |   |  |
| AEM90-AN11-D32-W32-L150-Z03                        | ●                      | 32  | 3    | 32   | 150 | 50 | 11   |   |   |  |
| AEM90-AN11-D32-C32-L200-Z03                        | ●                      | 32  | 3    | 32   | 200 | 50 | 11   |   |   |  |
| AEM90-AN11-D40-W32-L150-Z04                        | ●                      | 40  | 4    | 32   | 150 | 40 | 11   |   |   |  |

R: Sağ / Right / Rechts / L: Sol / Left / Links

● Stokta / In Stock / Auf Lager ○ Stokta Yok / Non Stock Item / Kein Lagerartikel, Lieferzeit auf Anfrage  
ZCC Ucuna Uygundur. / Compatible with ZCC Insert. / Kompatibel mit ZCC Wendeplatten.

Sipariş Örneği/Ordering Example/Bestellbeispiel

1 ad./pcs./stück AEM90-AD1003-D16-C16-L150-Z02

Kesme Hesabı : S 377 / Cutting Calculation : P 377 / Schnittberechnung : P 377



www.akkо.com.tr

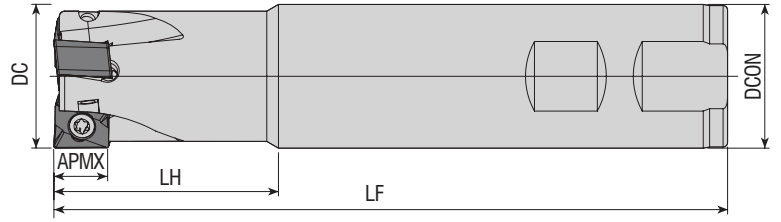

| Takım Kodu<br>Ordering Code<br>Bestell-Bezeichnung | Stok<br>Stock<br>Lager | Takım Ölçüleri (mm)<br>Dimension (mm)<br>Abmessung (mm) |      |      |     |    |      | Kesici Uç<br>Insert<br>Wendeschneidplatte | Yedek Parçaları / Spare Parts / Ersatzteile |  |  |
|--|------------------------|---|------|------|-----|----|------|---|---|--|--|
|  |                        | DC  | ZEFP | DCON | LF  | LH | APMX |   | Sıkma Vidası<br>Screw<br>Schraube           | Tork Anahtar<br>Torx Key<br>Torx-Schlüssel |  |
| AEM90-AN1207-D25-W25-L150-Z02                      | ●                      | 25  | 2    | 25   | 150 | 40 | 10   | ANKX 1207..                               | 4015-M4x11                                  | 80-T15                                     |  |
| AEM90-AN1207-D32-W32-L150-Z03                      | ●                      | 32  | 3    | 32   | 150 | 50 | 10   |   |   |  |  |
| AEM90-AN1207-D40-W32-L150-Z04                      | ●                      | 40  | 4    | 32   | 150 | 40 | 10   |   |   |  |  |

XTC-GSC Ucuna Uygun. / Compatible with XTC-GSC Insert. / Kompatibel mit XTC-GSC Wendeplatten.

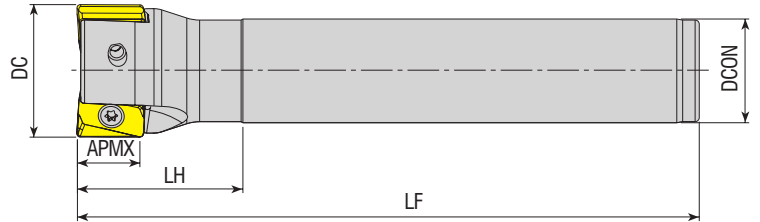

| Takım Kodu<br>Ordering Code<br>Bestell-Bezeichnung | Stok<br>Stock<br>Lager | Takım Ölçüleri (mm)<br>Dimension (mm)<br>Abmessung (mm) |      |      |     |    |      | Kesici Uç<br>Insert<br>Wendeschneidplatte | Yedek Parçaları / Spare Parts / Ersatzteile |  |  |
|--|------------------------|---|------|------|-----|----|------|---|---|--|--|
|  |                        | DC  | ZEFP | DCON | LF  | LH | APMX |   | Sıkma Vidası<br>Screw<br>Schraube           | Tork Anahtar<br>Torx Key<br>Torx-Schlüssel |  |
| AEM90-AN1607-D32-C25-L150-Z02                      | ●                      | 32  | 2    | 25   | 150 | 50 | 15   | AN.X 1607..                               | 4015-M4x11                                  | 80-T15                                     |  |
| AEM90-AN1607-D40-C32-L150-Z03                      | ●                      | 40  | 3    | 32   | 150 | 50 | 15   |   |   |  |  |

R: Sağ / Right / Rechts/ L: Sol / Left / Links

● Stokta / In Stock / Auf Lager ○ Stokta Yok / Non Stock Item / Kein Lagerartikel, Lieferzeit auf Anfrage

TGTC Ucuna Uygun. / Compatible with TGTC Insert. / Kompatibel mit TGTC Wendeplatten.

Sipariş Örneği/Ordering Example/Bestellbeispiel

1 ad./pcs./stück AEM90-AN1207-D25-W25-L150-Z02

Kesme Hesabı : S 377 / Cutting Calculation : P 377 / Schnittberechnung : P 377

KAPR=90°

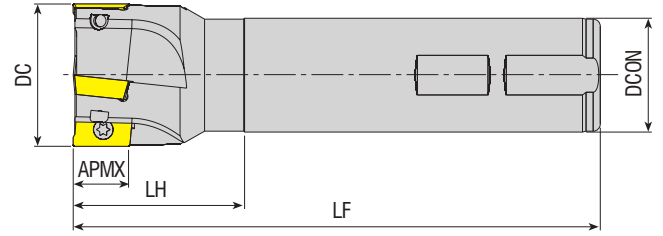

| Takım Kodu<br>Ordering Code<br>Bestell-Bezeichnung | Stok<br>Stock<br>Lager | Takım Ölçüleri (mm)<br>Dimension (mm)<br>Abmessung (mm) |      |      |     |     |      | Kesici Uç<br>Insert<br>Wendeschneidplatte                                       | Yedek Parçaları / Spare Parts / Ersatzteile |  |
|--|------------------------|---|------|------|-----|-----|------|---|---|--|
|  |                        | DC  | ZEFP | DCON | LF  | LH  | APMX |   | Sıkma Vidası<br>Screw<br>Schraube           | Tork Anahtar<br>Torx Key<br>Torx-Schlüssel |
| AEM90-AP06-D10-C10-L120-Z02                        | ●                      | 10  | 2    | 10   | 120 | 20  | 5.6  | APMT 0602..<br>KRLY UCUNA UYGUNDUR.<br>FOR KRLY INSERT. Kompatibel mit KRLY     | 3006-M1.8x4                                 | 82-T06                                     |
| AEM90-AP06-D12-C12-L120-Z02                        | ●                      | 12  | 2    | 12   | 120 | 20  | 5.6  |   |   |  |
| AEM90-AP0903-D12-C16-L080-Z01-H                    | ●                      | 12  | 1    | 16   | 80  | 30  | 9    | APMT 0903..<br><br>KRLY UCUNA UYGUNDUR.<br>FOR KRLY INSERT. Kompatibel mit KRLY | 3008-M2.5x5                                 |  |
| AEM90-AP0903-D16-C16-L090-Z02                      | ●                      | 16  | 2    | 16   | 90  | 30  | 9    |   |   |  |
| AEM90-AP0903-D16-C16-L150-Z02                      | ●                      | 16  | 2    | 16   | 150 | 30  | 9    |   |   |  |
| AEM90-AP0903-D17-C16-L150-Z02                      | ●                      | 17  | 2    | 16   | 150 | 30  | 9    |   |   |  |
| AEM90-AP0903-D18-C16-L090-Z02-H                    | ●                      | 18  | 2    | 16   | 90  | 30  | 9    |   |   |  |
| AEM90-AP0903-D20-C20-L110-Z03                      | ●                      | 20  | 3    | 20   | 110 | 30  | 9    |   |   |  |
| AEM90-AP0903-D20-C20-L150-Z02                      | ●                      | 20  | 2    | 20   | 150 | 30  | 9    |   |   |  |
| AEM90-AP0903-D20-C20-L200-Z02                      | ●                      | 20  | 2    | 20   | 200 | 100 | 9    |   |   |  |
| AEM90-AP0903-D21-C20-L150-Z02                      | ●                      | 21  | 2    | 20   | 150 | 30  | 9    |   |   |  |
| AEM90-AP0903-D25-C25-L120-Z03                      | ●                      | 25  | 3    | 25   | 120 | 30  | 9    |   |   |  |
| AEM90-AP0903-D25-C25-L150-Z03                      | ●                      | 25  | 3    | 25   | 150 | 30  | 9    |   |   |  |
| AEM90-AP0903-D25-C25-L200-Z02                      | ●                      | 25  | 2    | 25   | 200 | 100 | 9    |   |   |  |
| AEM90-AP09-D16-C16-L100-Z02-H                      | ●                      | 16  | 2    | 16   | 100 | 30  | 8.8  | APKT 09T3..<br><br>TGTC UCUNA UYGUNDUR.<br>FOR TGTC INSERT. Kompatibel mit TGTC | 3008-M2.5x5                                 | 82-T08                                     |
| AEM90-AP09-D16-C15-L150-Z02                        | ●                      | 16  | 2    | 15   | 150 | 25  | 8.8  |   |   |  |
| AEM90-AP09-D16-W16-L150-Z02-H                      | ●                      | 16  | 2    | 16   | 150 | 25  | 8.8  |   |   |  |
| AEM90-AP09-D16-C16-L200-Z02-H                      | ●                      | 16  | 2    | 16   | 200 | 100 | 8.8  |   |   |  |
| AEM90-AP09-D17-C16-L150-Z02                        | ●                      | 17  | 2    | 16   | 150 | 25  | 8.8  |   |   |  |
| AEM90-AP09-D17-C16-L180-Z02-H                      | ●                      | 17  | 2    | 16   | 180 | 25  | 8.8  |   |   |  |
| AEM90-AP09-D20-C20-L150-Z03-H                      | ●                      | 20  | 3    | 20   | 150 | 50  | 8.8  |   |   |  |
| AEM90-AP09-D20-C20-L200-Z03-H                      | ●                      | 20  | 3    | 20   | 200 | 100 | 8.8  |   |   |  |
| AEM90-AP09-D20-C20-L250-Z02-H                      | ●                      | 20  | 2    | 20   | 250 | 150 | 8.8  |   |   |  |
| AEM90-AP09-D21-C20-L150-Z03                        | ●                      | 21  | 3    | 20   | 150 | 25  | 8.8  |   |   |  |
| AEM90-AP09-D21-C20-L180-Z02-H                      | ●                      | 21  | 2    | 20   | 180 | 25  | 8.8  |   |   |  |
| AEM90-AP09-D26-C25-L150-Z04                        | ●                      | 26  | 4    | 25   | 150 | 30  | 8.8  |   |   |  |
| AEM90-AP10-D10-C10-L100-Z01                        | ●                      | 10  | 1    | 10   | 100 | 20  | 10   | AP. 1003..<br><br>ISO UCUNA UYGUNDUR.<br>FOR ISO INSERT. Kompatibel mit ISO     | 3008-M2.5x5                                 |  |
| AEM90-AP10-D12-C16-L100-Z01-H                      | ●                      | 12  | 1    | 16   | 100 | 30  | 10   |   |   |  |
| AEM90-AP10-D12-W16-L100-Z01-H                      | ●                      | 12  | 1    | 16   | 100 | 30  | 10   |   |   |  |
| AEM90-AP10-D12-W16-L150-Z01                        | ●                      | 12  | 1    | 16   | 150 | 38  | 10   |   |   |  |
| AEM90-AP10-D14-W16-L100-Z01-H                      | ●                      | 14  | 1    | 16   | 100 | 30  | 10   |   |   |  |
| AEM90-AP10-D14-W16-L150-Z01                        | ●                      | 14  | 1    | 16   | 150 | 38  | 10   |   |   |  |
| AEM90-AP10-D16-C16-L100-Z02-H                      | ●                      | 16  | 2    | 16   | 100 | 30  | 10   |   |   |  |
| AEM90-AP10-D16-W16-L85-Z02-H                       | ●                      | 16  | 2    | 16   | 85  | 30  | 10   |   |   |  |
| AEM90-AP10-D16-W16-L100-Z02-H                      | ●                      | 16  | 2    | 16   | 100 | 30  | 10   |   |   |  |
| AEM90-AP10-D16-W16-L150-Z02-H                      | ●                      | 16  | 2    | 16   | 150 | 50  | 10   |   |   |  |
| AEM90-AP10-D16-W16-L200-Z02                        | ●                      | 16  | 2    | 16   | 200 | 100 | 10   |   |   |  |
| AEM90-AP10-D16-C16-L120-Z02-H                      | ●                      | 16  | 2    | 16   | 120 | 30  | 10   |   |   |  |

R: Sağ / Right / Rechts/ L: Sol / Left / Links

● Stokta / In Stock / Auf Lager ○ Stokta Yok / Non Stock Item / Kein Lagerartikel, Lieferzeit auf Anfrage

Sipariş Örneği/Ordering Example/Bestellbeispiel

1 ad./pcs./stück AEM90-AP06-D10-C10-L120-Z02

Kesme Hesabı : S 377/ Cutting Calculation : P 377 / Schnittberechnung : P 377

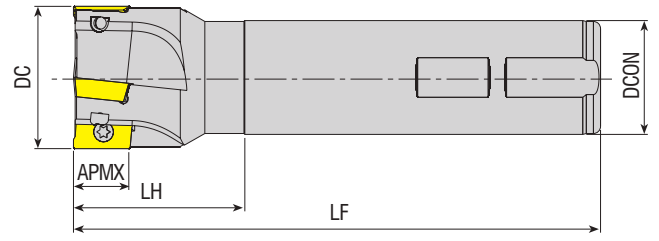

**Takım Kodu**  
**Ordering Code**  
*Bestell-Bezeichnung*

Stok  
Stock  
Lager

Takım Ölçüleri (mm)  
Dimension (mm)  
Abmessung (mm)

Kesici Uç  
Insert  
Wendeschneidplatte

Yedek Parçaları / Spare Parts / Ersatzteile

Sıkma Vidası  
Screw  
Schraube

Tork Anahtar  
Torx Key  
Torx-Schlüssel

DC ZEFP DCON LF LH APMX



|                                   |   |      |   |    |     |     |    |
|-----------------------------------|---|------|---|----|-----|-----|----|
| AEM90-AP10-D16-C16-L150-Z02       | ● | 16   | 2 | 16 | 150 | 50  | 10 |
| AEM90-AP10-D16-C16-L150-Z02-H     | ● | 16   | 2 | 16 | 150 | 50  | 10 |
| AEM90-AP10-D16-W16-L150-Z02       | ● | 16   | 2 | 16 | 150 | 50  | 10 |
| AEM90-AP10-D16-C16-L200-Z02       | ● | 16   | 2 | 16 | 200 | 100 | 10 |
| AEM90-AP10-D16-C16-L200-Z02-H     | ● | 16   | 2 | 16 | 200 | 100 | 10 |
| AEM90-AP10-D16-C16-L250-Z02       | ● | 17   | 2 | 16 | 150 | 30  | 10 |
| new AEM90-AP10-D17-C16-L150-Z02   | ● | 17   | 2 | 16 | 250 | 150 | 10 |
| AEM90-AP10-D18-W16-L100-Z02-H     | ● | 18   | 2 | 16 | 100 | 30  | 10 |
| AEM90-AP10-D18-W16-L150-Z02       | ● | 18   | 2 | 16 | 150 | 30  | 10 |
| new AEM90-AP10-D20-C19-L180-Z02   | ● | 20   | 2 | 19 | 180 | 30  | 10 |
| AEM90-AP10-D20-C20-L100-Z03-H     | ● | 20   | 3 | 20 | 100 | 30  | 10 |
| new AEM90-AP10-D20-W20-L90-Z03-H  | ● | 20   | 3 | 20 | 90  | 30  | 10 |
| AEM90-AP10-D20-W20-L100-Z03-H     | ● | 20   | 3 | 20 | 100 | 30  | 10 |
| AEM90-AP10-D20-C20-L120-Z03-H     | ● | 20   | 3 | 20 | 120 | 30  | 10 |
| AEM90-AP10-D20-C20-L150-Z03       | ● | 20   | 3 | 20 | 150 | 50  | 10 |
| AEM90-AP10-D20-C20-L150-Z03-H     | ● | 20   | 3 | 20 | 150 | 50  | 10 |
| AEM90-AP10-D20-W20-L150-Z03       | ● | 20   | 3 | 20 | 150 | 50  | 10 |
| AEM90-AP10-D20-C20-L200-Z02       | ● | 20   | 2 | 20 | 200 | 100 | 10 |
| AEM90-AP10-D20-C20-L200-Z03-H     | ● | 20   | 3 | 20 | 200 | 100 | 10 |
| AEM90-AP10-D20-C20-L250-Z02       | ● | 20   | 2 | 20 | 250 | 150 | 10 |
| AEM90-AP10-D20-C20-L250-Z02-H     | ● | 20   | 2 | 20 | 250 | 150 | 10 |
| new AEM90-AP10-D20.5-C20-L90-Z03  | ● | 20.5 | 3 | 20 | 90  | 30  | 10 |
| new AEM90-AP10-D21-C20-L150-Z03   | ● | 21   | 3 | 20 | 200 | 35  | 10 |
| AEM90-AP10-D21-C20-L200-Z03       | ● | 21   | 3 | 20 | 200 | 30  | 10 |
| new AEM90-AP10-D21-C20-L200-Z03-H | ● | 21   | 3 | 20 | 200 | 35  | 10 |
| AEM90-AP10-D21-W20-L150-Z03       | ● | 21   | 3 | 20 | 150 | 30  | 10 |
| AEM90-AP10-D22-W20-L100-Z03-H     | ● | 22   | 3 | 20 | 100 | 30  | 10 |
| AEM90-AP10-D22-W20-L150-Z03       | ● | 22   | 3 | 20 | 150 | 30  | 10 |
| new AEM90-AP10-D22.5-W20-L150-Z03 | ● | 22.5 | 3 | 20 | 150 | 30  | 10 |
| AEM90-AP10-D23-W20-L150-Z03       | ● | 23   | 3 | 20 | 150 | 30  | 10 |
| AEM90-AP10-D24-W20-L150-Z03       | ● | 24   | 3 | 20 | 150 | 30  | 10 |
| AEM90-AP10-D25-W25-L100-Z04-H     | ● | 25   | 4 | 25 | 100 | 30  | 10 |
| new AEM90-AP10-D25-W25-L95-Z04-H  | ● | 25   | 4 | 25 | 95  | 30  | 10 |
| new AEM90-AP10-D25-W25-L150-Z04-H | ● | 25   | 4 | 25 | 150 | 50  | 10 |
| AEM90-AP10-D25-C25-L100-Z03-H     | ● | 25   | 3 | 25 | 100 | 30  | 10 |
| AEM90-AP10-D25-W25-L100-Z03-H     | ● | 25   | 3 | 25 | 100 | 30  | 10 |
| AEM90-AP10-D25-C25-L120-Z03-H     | ● | 25   | 3 | 25 | 120 | 30  | 10 |
| AEM90-AP10-D25-C25-L150-Z03       | ● | 25   | 3 | 25 | 150 | 50  | 10 |
| AEM90-AP10-D25-W25-L150-Z03       | ● | 25   | 3 | 25 | 150 | 50  | 10 |
| AEM90-AP10-D25-C25-L200-Z02       | ● | 25   | 2 | 25 | 200 | 100 | 10 |
| AEM90-AP10-D25-C25-L200-Z03       | ● | 25   | 3 | 25 | 200 | 100 | 10 |
| AEM90-AP10-D25-C25-L250-Z02       | ● | 25   | 2 | 25 | 250 | 100 | 10 |
| new AEM90-AP10-D26-C25-L200-Z04   | ● | 26   | 4 | 25 | 200 | 35  | 10 |

AP. 1003..

ISO UCUNA  
UYGUNDUR.  
FOR ISO INSERT.  
Kompatibel mit ISO

3008-M2.5x5

82-T08

3008-M2.5x6

R: Sağ / Right / Rechtsl L: Sol / Left / Links

● Stokta / In Stock / Auf Lager ○ Stokta Yok / Non Stock Item / Kein Lagerartikel, Lieferzeit auf Anfrage









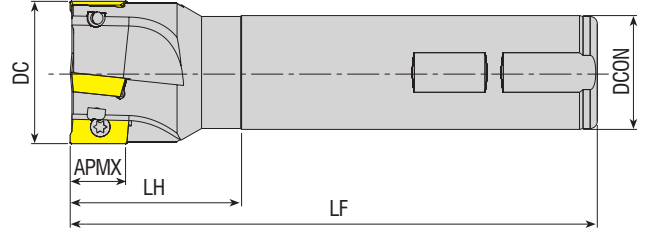



Sipariş Örneği/Ordering Example/Bestellbeispiel

1 ad./pcs./stück AEM90-AP10-D16-C16-L150-Z02

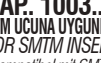
Kesme Hesabı : S 377/ Cutting Calculation : P 377 / Schnittberechnung : P 377

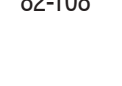
KAPR=90°



| Takım Kodu<br>Ordering Code<br>Bestell-Bezeichnung | Stok<br>Stock<br>Lager | Takım Ölçüleri (mm)<br>Dimension (mm)<br>Abmessung (mm) |      |      |     |     |      | Kesici Uç<br>Insert<br>Wendeschneidplatte   | Yedek Parçaları / Spare Parts / Ersatzteile  |   |  |   |   |
|--|------------------------|---|------|------|-----|-----|------|---|--|---|--|---|---|
|  |                        | DC  | ZEFP | DCON | LF  | LH  | APMX |   | Sıkma Vidası<br>Screw<br>Schraube  | Tork Anahtar<br>Torx Key<br>Torx-Schlüssel  |  |   |   |
| AEM90-AP10-D30-C25-L100-Z04-H                      | ●                      | 30  | 4    | 25   | 100 | 30  | 10   | <br><b>AP. 1003..</b><br>ISO UCUNA UYGUNDUR.<br>FOR ISO INSERT.<br>Kompatibel mit ISO                    | <br>3008-M2.5x6   |    |  |   |   |
| AEM90-AP10-D30-C25-L120-Z04-H                      | ●                      | 30  | 4    | 25   | 120 | 30  | 10   |   |  |   |  |   |   |
| AEM90-AP10-D30-C25-L150-Z04                        | ●                      | 30  | 4    | 25   | 150 | 30  | 10   |   |  |   |  |   |   |
| AEM90-AP10-D32-C25-L100-Z04-H                      | ●                      | 32  | 4    | 25   | 100 | 35  | 10   |   |  |   |  |   |   |
| AEM90-AP10-D32-C25-L120-Z04-H                      | ●                      | 32  | 4    | 25   | 120 | 35  | 10   |   |  |   |  |   |   |
| AEM90-AP10-D32-C25-L150-Z04                        | ●                      | 32  | 4    | 25   | 150 | 35  | 10   |   |  |   |  |   |   |
| AEM90-AP10-D32-W25-L150-Z04                        | ●                      | 32  | 4    | 25   | 150 | 35  | 10   |   |  |   |  |   |   |
| <b>new</b> AEM90-AP10-D32-C32-L170-Z04             | ●                      | 32  | 4    | 32   | 170 | 50  | 10   |   |  |   |  |   |   |
| <b>new</b> AEM90-AP10-D32-W25-L105-Z05-H           | ●                      | 32  | 5    | 25   | 105 | 35  | 10   |   |  |   |  |   |   |
| AEM90-AP10-D32-C32-L130-Z05                        | ●                      | 32  | 5    | 32   | 130 | 30  | 10   |   |  |   |  |   |   |
| AEM90-AP10-D32-W32-L150-Z04                        | ●                      | 32  | 4    | 32   | 150 | 50  | 10   |   |  |   |  |   |   |
| AEM90-AP10-D40-W32-L150-Z05                        | ●                      | 40  | 5    | 32   | 150 | 40  | 10   |   |  |   |  |   |   |
| AEM90-AP10D-D16-W16-L150-Z02                       | ●                      | 16  | 2    | 16   | 150 | 50  | 10   | <br><b>AP. 1003..</b><br>DJT UCUNA UYGUNDUR.<br>FOR DJT INSERT. Kompatibel mit DJT                     | <br>3008-M2.5x5 |  |  |   |   |
| AEM90-AP10D-D20-W20-L150-Z03                       | ●                      | 20  | 3    | 20   | 150 | 50  | 10   |   |  |   |  |   |   |
| AEM90-AP10D-D25-W20-L150-Z03                       | ●                      | 25  | 3    | 20   | 150 | 30  | 10   |   |  |   |  |   |   |
| AEM90-AP100-D16-C15-L150-Z02                       | ●                      | 16  | 2    | 15   | 150 | 30  | 10   |   |  |   |  |   |   |
| AEM90-AP100-D21-C20-L150-Z03                       | ●                      | 21  | 3    | 20   | 150 | 30  | 10   |   |  |   |  |   |   |
| AEM90-AP100-D26-C25-L150-Z04                       | ●                      | 26  | 4    | 25   | 150 | 35  | 10   |   |  |   |  |   |   |
| AEM90-AP100-D33-C32-L200-Z05                       | ●                      | 33  | 5    | 32   | 200 | 50  | 10   |   |  |   |  |   |   |
| AEM90-AP10S-D16-W16-L150-Z02                       | ●                      | 16  | 2    | 16   | 150 | 26  | 10   |   |  |   | <br><b>AP. 1003..</b><br>SMTM UCUNA UYGUNDUR.<br>FOR SMTM INSERT<br>Kompatibel mit SMTM |  |  |
| AEM90-AP10S-D20-W20-L150-Z02                       | ●                      | 20  | 2    | 20   | 150 | 26  | 10   |   |  |   |  |   |   |
| AEM90-AP10S-D25-W25-L150-Z03                       | ●                      | 25  | 3    | 25   | 150 | 26  | 10   |   |  |   |  |   |   |
| AEM90-AP11-D16-C16-L150-Z02                        | ●                      | 16  | 2    | 16   | 150 | 50  | 11   |   |  |   |  |   |   |
| AEM90-AP11-D16-C16-L150-Z02-H                      | ●                      | 16  | 2    | 16   | 150 | 50  | 11   |   |  |   |  |   |   |
| AEM90-AP11-D16-W16-L150-Z02                        | ●                      | 16  | 2    | 16   | 150 | 50  | 11   |   |  |   |  |   |   |
| AEM90-AP11-D16-W16-L150-Z02-H                      | ●                      | 16  | 2    | 16   | 150 | 50  | 11   |   |  |   |  |   |   |
| AEM90-AP11-D16-C16-L200-Z02                        | ●                      | 16  | 2    | 16   | 200 | 100 | 11   |   |  |   |  |   |   |
| AEM90-AP11-D17-C16-L150-Z02                        | ●                      | 17  | 2    | 16   | 150 | 30  | 11   |   |  |   |  |   |   |
| AEM90-AP11-D17-C16-L200-Z02                        | ●                      | 17  | 2    | 16   | 200 | 30  | 11   |   |  |   |  |   |   |
| AEM90-AP11-D20-C20-L150-Z03                        | ●                      | 20  | 3    | 20   | 150 | 50  | 11   | <br><b>AP. 11T3..</b><br>ZCC UCUNA UYGUNDUR.<br>FOR ZCC INSERT.<br>Kompatibel mit ZCC<br>Wendeplatten. | <br>3008-M2.5x6 |  |  |   |   |
| AEM90-AP11-D20-W20-L150-Z03                        | ●                      | 20  | 3    | 20   | 150 | 50  | 11   |   |  |   |  |   |   |
| AEM90-AP11-D20-W20-L150-Z03-H                      | ●                      | 20  | 3    | 20   | 150 | 50  | 11   |   |  |   |  |   |   |
| AEM90-AP11-D20-C20-L200-Z03                        | ●                      | 20  | 3    | 20   | 200 | 100 | 11   |   |  |   |  |   |   |
| AEM90-AP11-D21-C20-L150-Z03                        | ●                      | 21  | 3    | 20   | 150 | 30  | 11   |   |  |   |  |   |   |
| AEM90-AP11-D21-W20-L150-Z03                        | ●                      | 21  | 3    | 20   | 150 | 30  | 11   |   |  |   |  |   |   |
| AEM90-AP11-D21-W20-L150-Z03-H                      | ●                      | 21  | 3    | 20   | 150 | 30  | 11   |   |  |   |  |   |   |
| AEM90-AP11-D21-C20-L200-Z03                        | ●                      | 21  | 3    | 20   | 200 | 30  | 11   |   |  |   |  |   |   |
| <b>new</b> AEM90-AP11-D22-C20-L180-Z03-H           | ●                      | 22  | 3    | 20   | 180 | 30  | 11   |   |  |   |  |   |   |
| AEM90-AP11-D25-C25-L150-Z03                        | ●                      | 25  | 3    | 25   | 150 | 50  | 11   |   |  |   |  |   |   |
| AEM90-AP11-D25-W25-L150-Z03                        | ●                      | 25  | 3    | 25   | 150 | 50  | 11   |   |  |   |  |   |   |
| AEM90-AP11-D25-W25-L150-Z03-H                      | ●                      | 25  | 3    | 25   | 150 | 50  | 11   |   |  |   |  |   |   |
| AEM90-AP11-D26-C25-L150-Z03                        | ●                      | 26  | 3    | 25   | 150 | 35  | 11   |   |  |   |  |   |   |
| AEM90-AP11-D26-C24-L150-Z03                        | ●                      | 26  | 3    | 24   | 150 | 35  | 11   |   |  |   |  |   |   |
| <b>new</b> AEM90-AP11-D28-C25-L180-Z03-H           | ●                      | 28  | 3    | 25   | 180 | 30  | 11   |   |  |   |  |   |   |
| AEM90-AP11-D32-W25-L150-Z04                        | ●                      | 32  | 4    | 25   | 150 | 35  | 11   |   |  |   |  |   |   |
| AEM90-AP11-D32-W32-L150-Z03-H                      | ●                      | 32  | 3    | 32   | 150 | 50  | 11   |   |  |   |  |   |   |
| AEM90-AP11-D32-W32-L150-Z04                        | ●                      | 32  | 4    | 32   | 150 | 50  | 11   |   |  |   |  |   |   |

R: Sağ / Right / Rechts / L: Sol/Left/Links / ● Stokta / In Stock / Auf Lager ○ Stokta Yok / Non Stock Item / Kein Lagerartikel, Lieferzeit auf Anfrage

Sipariş Örneği/Ordering Example/Bestellbeispiel

1 ad./pcs./stück AEM90-AP10-D30-C25-L100-Z04-H

Kesme Hesabı : S 377/ Cutting Calculation : P 377 / Schnittberechnung : P 377



www.akkо.com.tr

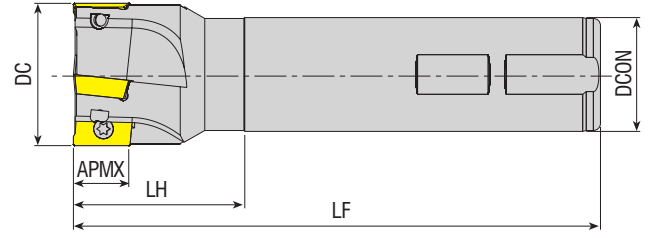

**Takım Kodu**  
**Ordering Code**  
*Bestell-Bezeichnung*

Stok  
Stock  
Lager

Takım Ölçüleri (mm)  
Dimension (mm)  
Abmessung (mm)

Kesici Uç  
Insert  
Wendeschneidplatte

Yedek Parçaları / Spare Parts / Ersatzteile

Sıkma Vidası  
Screw  
Schraube

Tork Anahtar  
Torx Key  
Torx-Schlüssel

| Stok | DC | ZEP | DCON | LF  | LH  | APMX | Kesici Uç  | Sıkma Vidası | Tork Anahtar |   |             |        |
|------|----|-----|------|-----|-----|------|--|--------------|--------------|---|-------------|--------|
| ●    | 14 | 1   | 16   | 150 | 40  | 9.5  | APMT 1135..<br>ACHTK UCUNA UYGUNDUR.<br>FOR ACHTK INSERT.<br>Kompatibel mit ACHTK      | 3008-M2.5x5  | 82-T08       |   |             |        |
| ●    | 16 | 2   | 16   | 150 | 40  | 9.5  |  |              |              |   |             |        |
| ●    | 16 | 2   | 16   | 200 | 100 | 9.5  |  |              |              |   |             |        |
| ●    | 16 | 2   | 16   | 250 | 150 | 9.5  |  |              |              |   |             |        |
| ●    | 17 | 2   | 16   | 180 | 30  | 9.5  |  |              |              |   |             |        |
| ●    | 20 | 3   | 20   | 150 | 50  | 9.5  |  |              |              |   |             |        |
| ●    | 20 | 2   | 20   | 200 | 100 | 9.5  |  |              |              |   |             |        |
| ●    | 21 | 2   | 20   | 180 | 30  | 9.5  |  |              |              |   |             |        |
| ●    | 25 | 3   | 25   | 200 | 100 | 9.5  |  |              |              |   |             |        |
| ●    | 26 | 2   | 25   | 250 | 35  | 9.5  |  |              |              |   |             |        |
| ●    | 33 | 2   | 32   | 250 | 35  | 9.5  |  |              |              |   |             |        |
| ●    | 16 | 2   | 15   | 150 | 30  | 11   | AP. 1135..<br>B.OKE UCUNA UYGUNDUR.<br>FOR B.OKE INSERT<br>Kompatibel mit B.OKE        | 3008-M2.5x5  | 82-T08       |   |             |        |
| ●    | 21 | 3   | 20   | 150 | 30  | 11   |  |              |              |   |             |        |
| ●    | 26 | 4   | 25   | 150 | 35  | 11   |  |              |              |   |             |        |
| ●    | 33 | 5   | 32   | 200 | 50  | 11   |  |              |              |   |             |        |
| ●    | 16 | 2   | 16   | 150 | 26  | 11   |  |              |              |   |             |        |
| ●    | 20 | 3   | 20   | 150 | 26  | 11   | APKT 1135..<br>XTC-GSC UCUNA UYGUNDUR.<br>FOR XTC-GSC INSERT<br>Kompatibel mit XTC-GSC | 3008-M3x5    | 82-T08       |   |             |        |
| ●    | 25 | 3   | 25   | 150 | 26  | 11   |  |              |              |   |             |        |
| ●    | 25 | 3   | 25   | 150 | 26  | 11   |  |              |              |   |             |        |
| ●    | 16 | 2   | 16   | 110 | 30  | 9.5  | AP. 1135..<br>XTC-GSC UCUNA UYGUNDUR.<br>FOR XTC-GSC INSERT.<br>Kompatibel mit XTC-GSC | 3008-M2.5x6  | 82-T10       |   |             |        |
| ●    | 16 | 2   | 16   | 150 | 50  | 9.5  |  |              |              |   |             |        |
| ●    | 20 | 3   | 20   | 125 | 30  | 9.5  |  |              |              |   |             |        |
| ●    | 20 | 3   | 20   | 150 | 50  | 9.5  |  |              |              |   |             |        |
| ●    | 25 | 4   | 25   | 125 | 30  | 9.5  |  |              |              |   |             |        |
| ●    | 25 | 4   | 25   | 200 | 100 | 9.5  |  |              |              |   |             |        |
| ●    | 32 | 5   | 32   | 125 | 30  | 9.5  |  |              |              |   |             |        |
| ●    | 32 | 4   | 32   | 200 | 100 | 9.5  |  |              |              |   |             |        |
| ●    | 16 | 2   | 16   | 120 | 30  | 9.5  |  |              |              |   |             |        |
| ●    | 16 | 2   | 16   | 150 | 50  | 9.5  |  |              |              |   |             |        |
| ●    | 17 | 2   | 16   | 150 | 30  | 9.5  | APMT 1135..<br>YG UCUNA UYGUNDUR.<br>FOR YG INSERT.<br>Kompatibel mit YG               | 3008-M2.5x6  | 82-T10       |   |             |        |
| ●    | 20 | 2   | 20   | 120 | 30  | 9.5  |  |              |              |   |             |        |
| ●    | 20 | 3   | 20   | 150 | 50  | 9.5  |  |              |              |   |             |        |
| ●    | 21 | 3   | 20   | 150 | 30  | 9.5  |  |              |              |   |             |        |
| ●    | 25 | 3   | 25   | 150 | 50  | 9.5  |  |              |              |   |             |        |
| ●    | 25 | 4   | 25   | 150 | 30  | 9.5  |  |              |              |   |             |        |
| ●    | 26 | 3   | 25   | 150 | 35  | 9.5  |  |              |              |   |             |        |
| ●    | 32 | 4   | 25   | 110 | 35  | 9.5  |  |              |              |   |             |        |
| ●    | 20 | 2   | 20   | 150 | 30  | 12   |  |              |              | AP. 1204..<br>TGTC UCUNA UYGUNDUR.<br>FOR TGTC INSERT.<br>Kompatibel mit TGTC | 3010-M3.5x7 | 82-T10 |
| ●    | 21 | 2   | 20   | 150 | 30  | 12   |  |              |              |   |             |        |
| ●    | 21 | 2   | 20   | 200 | 30  | 12   |  |              |              |   |             |        |
| ●    | 22 | 2   | 20   | 200 | 30  | 12   |  |              |              |   |             |        |
| ●    | 25 | 3   | 25   | 150 | 40  | 12   |  |              |              |   |             |        |
| ●    | 25 | 3   | 25   | 250 | 40  | 12   |  |              |              |   |             |        |
| ●    | 26 | 2   | 25   | 250 | 35  | 12   |  |              |              |   |             |        |
| ●    | 32 | 3   | 25   | 150 | 35  | 12   |  |              |              |   |             |        |

new

new

R: Sağ / Right / Rechts L: Sol / Left / Links

● Stokta / In Stock / Auf Lager ○ Stokta Yok / Non Stock Item / Kein Lagerartikel, Lieferzeit auf Anfrage

Sipariş Örneği/Ordering Example/Bestellbeispiel

1 ad./pcs./stück AEM90-AP1135A-D14-C16-L150-Z01

Kesme Hesabı : S 377/ Cutting Calculation : P 377 / Schnittberechnung : P 377



# S-SİSTEM YÜZEY PARMAK FREZELER

S-SYSTEM END MILLS

S-SYSTEM SCHAFTFRÄSER

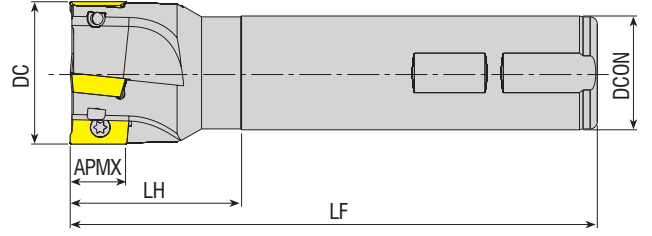
KAPR=90°



| Takım Kodu<br>Ordering Code<br>Bestell-Bezeichnung | Stok<br>Stock<br>Lager | Takım Ölçüleri (mm)<br>Dimension (mm)<br>Abmessung (mm) |      |      |     |     |      | Kesici Uç<br>Insert<br>Wendeschneidplatte  | Yedek Parçaları / Spare Parts / Ersatzteile  |   |  |
|--|------------------------|---|------|------|-----|-----|------|--|--|---|--|
|  |                        | DC  | ZEPF | DCON | LF  | LH  | APMX |  | Sıkma Vidası<br>Screw<br>Schraube  | Tork Anahtar<br>Torx Key<br>Torx-Schlüssel  |  |
| AEM90-AP16-D25-C20-L100-Z02                        | ●                      | 25  | 2    | 20   | 100 | 35  | 16   | <br><b>AP. 1604..</b><br>ISO UCUNA<br>UYGUNDUR.<br>FOR ISO INSERT<br>Kompatibel mit ISO | <br>4015-M4x9 | <br>80-T15 |  |
| AEM90-AP16-D25-W25-L100-Z02-H                      | ●                      | 25  | 2    | 25   | 100 | 35  | 16   |  |  |   |  |
| AEM90-AP16-D25-W25-L150-Z02                        | ●                      | 25  | 2    | 25   | 150 | 50  | 16   |  |  |   |  |
| AEM90-AP16-D25-C25-L250-Z02                        | ●                      | 25  | 2    | 25   | 250 | 100 | 16   |  |  |   |  |
| AEM90-AP16-D28-W25-L100-Z03-H                      | ●                      | 28  | 3    | 25   | 100 | 40  | 16   |  |  |   |  |
| AEM90-AP16-D28-W25-L150-Z03                        | ●                      | 28  | 3    | 25   | 150 | 40  | 16   |  |  |   |  |
| AEM90-AP16-D30-W25-L110-Z03-H                      | ●                      | 30  | 3    | 25   | 110 | 40  | 16   |  |  |   |  |
| AEM90-AP16-D30-W25-L150-Z02                        | ●                      | 30  | 2    | 25   | 150 | 40  | 16   |  |  |   |  |
| AEM90-AP16-D30-W25-L150-Z03                        | ●                      | 30  | 3    | 25   | 150 | 40  | 16   |  |  |   |  |
| AEM90-AP16-D32-W32-L110-Z03-H                      | ●                      | 32  | 3    | 32   | 110 | 40  | 16   |  |  |   |  |
| AEM90-AP16-D32-C32-L150-Z03                        | ●                      | 32  | 3    | 32   | 150 | 50  | 16   |  |  |   |  |
| AEM90-AP16-D32-W25-L150-Z03                        | ●                      | 32  | 3    | 25   | 150 | 40  | 16   |  |  |   |  |
| AEM90-AP16-D32-W32-L150-Z03                        | ●                      | 32  | 3    | 32   | 150 | 50  | 16   |  |  |   |  |
| AEM90-AP16-D32-W32-L150-Z03-H                      | ●                      | 32  | 3    | 32   | 150 | 50  | 16   |  |  |   |  |
| AEM90-AP16-D32-C25-L200-Z03-H                      | ●                      | 32  | 3    | 25   | 200 | 40  | 16   |  |  |   |  |
| AEM90-AP16-D32-C32-L250-Z02                        | ●                      | 32  | 2    | 32   | 250 | 100 | 16   |  |  |   |  |
| AEM90-AP16-D32-C32-L250-Z03                        | ●                      | 32  | 3    | 32   | 250 | 100 | 16   |  |  |   |  |
| AEM90-AP16-D35-W32-L150-Z03                        | ●                      | 35  | 3    | 32   | 150 | 40  | 16   |  |  |   |  |
| AEM90-AP16-D36-W32-L110-Z03-H                      | ●                      | 36  | 3    | 32   | 110 | 40  | 16   |  |  |   |  |
| AEM90-AP16-D36-W32-L150-Z03                        | ●                      | 36  | 3    | 32   | 150 | 40  | 16   |  |  |   |  |
| AEM90-AP16-D40-W32-L110-Z04-H                      | ●                      | 40  | 4    | 32   | 110 | 40  | 16   |  |  |   |  |
| AEM90-AP16-D40-C32-L150-Z04                        | ●                      | 40  | 4    | 32   | 150 | 40  | 16   |  |  |   |  |
| AEM90-AP16-D40-W32-L150-Z04                        | ●                      | 40  | 4    | 32   | 150 | 40  | 16   |  |  |   |  |
| AEM90-AP16-D40-C32-L250-Z02                        | ●                      | 40  | 2    | 32   | 250 | 40  | 16   |  |  |   |  |
| AEM90-AP16-D40-C32-L250-Z04                        | ●                      | 40  | 4    | 32   | 250 | 40  | 16   |  |  |   |  |
| AEM90-AP16DJ-D25-W25-L150-Z02                      | ●                      | 25  | 2    | 25   | 150 | 50  | 16   | <b>AP. 1604..</b><br>DJT UCUNA<br>UYGUNDUR.<br>FOR DJT INSERT.<br>Kompatibel mit DJT   | 4015-M4x9  | 80-T15  |  |
| AEM90-AP16DJ-D25-C25-L200-Z02                      | ●                      | 25  | 2    | 25   | 200 | 50  | 16   |  |  |   |  |
| AEM90-AP16DJ-D32-W32-L150-Z03                      | ●                      | 32  | 3    | 32   | 150 | 50  | 16   |  |  |   |  |
| AEM90-AP16DJ-D32-C32-L180-Z03                      | ●                      | 32  | 3    | 32   | 180 | 50  | 16   |  |  |   |  |
| AEM90-AP16DJ-D32-C32-L200-Z03                      | ●                      | 32  | 3    | 32   | 200 | 50  | 16   |  |  |   |  |
| AEM90-AP16L-D25-C25-L120-Z02-H                     | ●                      | 25  | 2    | 25   | 120 | 45  | 16   | <b>AP. 1604..</b><br>LMN UCUNA<br>UYGUNDUR.<br>FOR LMN INSERT.<br>Kompatibel mit LMN   | 4015-M4x9  | 80-T15  |  |
| AEM90-AP16L-D25-C25-L150-Z02                       | ●                      | 25  | 2    | 25   | 150 | 55  | 16   |  |  |   |  |
| AEM90-AP16L-D25-C25-L200-Z02                       | ●                      | 25  | 2    | 25   | 200 | 55  | 16   |  |  |   |  |
| AEM90-AP16L-D25-C25-L250-Z02                       | ●                      | 25  | 2    | 25   | 250 | 100 | 16   |  |  |   |  |
| AEM90-AP16L-D30-W25-L120-Z03-H                     | ●                      | 30  | 3    | 25   | 120 | 40  | 16   |  |  |   |  |
| AEM90-AP16L-D32-C32-L120-Z03-H                     | ●                      | 32  | 3    | 32   | 120 | 45  | 16   |  |  |   |  |
| AEM90-AP16L-D32-C32-L150-Z03                       | ●                      | 32  | 3    | 32   | 150 | 55  | 16   |  |  |   |  |
| AEM90-AP16L-D32-C32-L200-Z03                       | ●                      | 32  | 3    | 32   | 200 | 55  | 16   |  |  |   |  |
| AEM90-AP16L-D32-C32-L250-Z03                       | ●                      | 32  | 3    | 32   | 250 | 100 | 16   |  |  |   |  |
| AEM90-AP16L-D36-W32-L130-Z03                       | ●                      | 36  | 3    | 32   | 130 | 40  | 16   |  |  |   |  |
| AEM90-AP16L-D40-C32-L120-Z04-H                     | ●                      | 40  | 4    | 32   | 120 | 40  | 16   |  |  |   |  |
| AEM90-AP16L-D40-C32-L150-Z04                       | ●                      | 40  | 4    | 32   | 150 | 40  | 16   |  |  |   |  |
| AEM90-AP16L-D40-C32-L200-Z04                       | ●                      | 40  | 4    | 32   | 200 | 40  | 16   |  |  |   |  |
| AEM90-AP16L-D40-C32-L250-Z04                       | ●                      | 40  | 4    | 32   | 250 | 40  | 16   |  |  |   |  |

R: Sağ / Right / Rechts/ L: Sol / Left / Links

● Stokta / In Stock / Auf Lager ○ Stokta Yok / Non Stock Item / Kein Lagerartikel, Lieferzeit auf Anfrage

Sipariş Örneği/Ordering Example/Bestellbeispiel

1 ad./pcs./stück AEM90-AP16-D25-C20-L100-Z02

Kesme Hesabı : S 377/ Cutting Calculation : P 377 / Schnittberechnung : P 377



www.akkо.com.tr



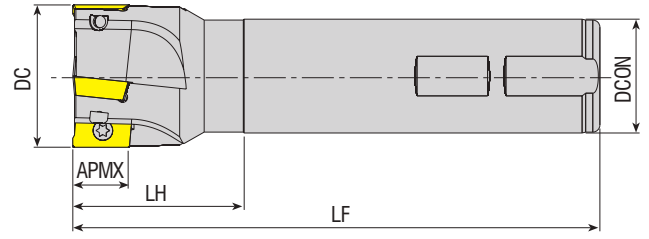

| Takım Kodu<br>Ordering Code<br>Bestell-Bezeichnung | Stok<br>Stock<br>Lager | Takım Ölçüleri (mm)<br>Dimension (mm)<br>Abmessung (mm) |      |      |     |     |      | Kesici Uç<br>Insert<br>Wendeschneidplatte  | Yedek Parçaları / Spare Parts / Ersatzteile |  |
|--|------------------------|---|------|------|-----|-----|------|--|---|--|
|  |                        | DC  | ZEFP | DCON | LF  | LH  | APMX |  | Sıkma Vidası<br>Screw<br>Schraube           | Tork Anahtar<br>Torx Key<br>Torx-Schlüssel |
| AEM90-AP16P-D25-W25-L100-Z02-H                     | ●                      | 25  | 2    | 25   | 100 | 35  | 16   | AP. 1604..<br>PLBT UCUNA<br>UYGUNDUR.<br>FOR PLBT INSERT.<br>Kompatibel mit PLBT             | 4015-M4x9                                   | 80-T15                                     |
| AEM90-AP16P-D25-W25-L150-Z02                       | ●                      | 25  | 2    | 25   | 150 | 50  | 16   |  |   |  |
| AEM90-AP16P-D32-W32-L150-Z03                       | ●                      | 32  | 3    | 32   | 150 | 50  | 16   | AP. 1604..<br>YG UCUNA<br>UYGUNDUR.<br>FOR YG INSERT.<br>Kompatibel mit YG                   | 4015-M4x9                                   | 80-T15                                     |
| AEM90-AP16P-D32-C32-L250-Z02                       | ●                      | 32  | 2    | 32   | 250 | 100 | 16   |  |   |  |
| AEM90-AP16P-D40-W32-L150-Z04                       | ●                      | 40  | 4    | 32   | 150 | 50  | 16   | AP. 1705..<br>TGTC-LMN UCUNA<br>UYGUNDUR.<br>FOR TGTC-LMN INSERT.<br>Kompatibel mit TGTC-LMN | 4015-M4x9                                   | 80-T15                                     |
| AEM90-AP16Y-D25-C20-L100-Z02-H                     | ●                      | 25  | 2    | 20   | 100 | 35  | 16   |  |   |  |
| AEM90-AP16Y-D25-C25-L120-Z02                       | ●                      | 25  | 2    | 25   | 120 | 50  | 16   | AP. 1705..<br>TGTC-LMN UCUNA<br>UYGUNDUR.<br>FOR TGTC-LMN INSERT.<br>Kompatibel mit TGTC-LMN | 4015-M4x9                                   | 80-T15                                     |
| AEM90-AP16Y-D25-C25-L150-Z02                       | ●                      | 25  | 2    | 25   | 150 | 50  | 16   |  |   |  |
| AEM90-AP16Y-D25-C25-L250-Z02                       | ●                      | 25  | 2    | 25   | 250 | 100 | 16   | AP. 1705..<br>TGTC-LMN UCUNA<br>UYGUNDUR.<br>FOR TGTC-LMN INSERT.<br>Kompatibel mit TGTC-LMN | 4015-M4x9                                   | 80-T15                                     |
| AEM90-AP1705-D25-C25-L120-Z02                      | ●                      | 25  | 2    | 25   | 120 | 40  | 16   |  |   |  |
| AEM90-AP1705-D26-C25-L200-Z02                      | ●                      | 26  | 2    | 25   | 200 | 40  | 16   | AP. 1705..<br>TGTC-LMN UCUNA<br>UYGUNDUR.<br>FOR TGTC-LMN INSERT.<br>Kompatibel mit TGTC-LMN | 4015-M4x9                                   | 80-T15                                     |
| AEM90-AP1705-D26-C25-L250-Z02                      | ●                      | 26  | 2    | 25   | 250 | 40  | 16   |  |   |  |
| AEM90-AP1705-D26-C25-L300-Z02                      | ○                      | 26  | 2    | 25   | 300 | 40  | 16   | AP. 1705..<br>TGTC-LMN UCUNA<br>UYGUNDUR.<br>FOR TGTC-LMN INSERT.<br>Kompatibel mit TGTC-LMN | 4015-M4x9                                   | 80-T15                                     |
| AEM90-AP1705-D28-W25-L075-Z02                      | ●                      | 28  | 2    | 25   | 75  | 20  | 16   |  |   |  |
| AEM90-AP1705-D32-C25-L150-Z03                      | ●                      | 32  | 3    | 25   | 150 | 40  | 16   | AP. 1705..<br>TGTC-LMN UCUNA<br>UYGUNDUR.<br>FOR TGTC-LMN INSERT.<br>Kompatibel mit TGTC-LMN | 4015-M4x9                                   | 80-T15                                     |
| AEM90-AP1705-D33-C32-L250-Z03                      | ●                      | 33  | 3    | 32   | 250 | 40  | 16   |  |   |  |
| AEM90-AP1705-D33-C32-L300-Z02                      | ●                      | 33  | 2    | 32   | 300 | 40  | 16   |  |   |  |

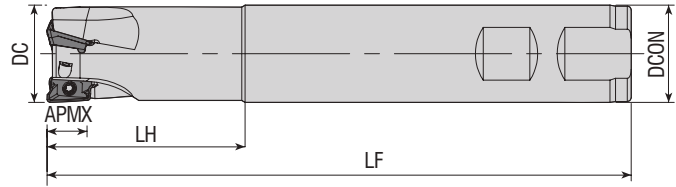

| Takım Kodu<br>Ordering Code<br>Bestell-Bezeichnung | Stok<br>Stock<br>Lager | Takım Ölçüleri (mm)<br>Dimension (mm)<br>Abmessung (mm) |      |      |     |    |      | Kesici Uç<br>Insert<br>Wendeschneidplatte | Yedek Parçaları / Spare Parts / Ersatzteile |  |
|--|------------------------|---|------|------|-----|----|------|---|---|--|
|  |                        | DC  | ZEFP | DCON | LF  | LH | APMX |   | Sıkma Vidası<br>Screw<br>Schraube           | Tork Anahtar<br>Torx Key<br>Torx-Schlüssel |
| AEM90-A01236-D16-W16-L150-Z02                      | ●                      | 16  | 2    | 16   | 150 | 50 | 10   | A0.1236..                                 | 3008-M2.5x6                                 | 82-T08                                     |
| new AEM90-A01236-D16-C16-L160-Z02-H                | ●                      | 16  | 2    | 16   | 160 | 25 | 10   |   |   |  |
| new AEM90-A01236-D17-C16-L150-Z02-H                | ●                      | 17  | 2    | 16   | 150 | 25 | 10   | A0.1236..                                 | 3008-M2.5x6                                 | 82-T08                                     |
| new AEM90-A01236-D18-C16-L160-Z02-H                | ●                      | 18  | 2    | 16   | 160 | 25 | 10   |   |   |  |
| new AEM90-A01236-D20-C20-L160-Z03-H                | ●                      | 20  | 3    | 20   | 160 | 30 | 10   | A0.1236..                                 | 3008-M2.5x6                                 | 82-T08                                     |
| AEM90-A01236-D20-C20-L100-Z02                      | ●                      | 20  | 2    | 20   | 100 | 30 | 10   |   |   |  |
| new AEM90-A01236-D21-C20-L220-Z03-H                | ●                      | 21  | 3    | 20   | 220 | 30 | 10   | A0.1236..                                 | 3008-M2.5x6                                 | 82-T08                                     |
| new AEM90-A01236-D22-C20-L160-Z03-H                | ●                      | 22  | 3    | 20   | 160 | 30 | 10   |   |   |  |
| AEM90-A01236-D25-C25-L115-Z02                      | ●                      | 25  | 2    | 25   | 150 | 50 | 10   | A0.1236..                                 | 3008-M2.5x6                                 | 82-T08                                     |
| new AEM90-A01236-D25-C25-L160-Z04-H                | ●                      | 25  | 4    | 25   | 160 | 50 | 10   |   |   |  |
| AEM90-A01236-D25-W25-L150-Z03                      | ●                      | 25  | 3    | 25   | 150 | 50 | 10   | A0.1236..                                 | 3008-M2.5x6                                 | 82-T08                                     |
| new AEM90-A01236-D26-C25-L150-Z04-H                | ●                      | 26  | 4    | 25   | 150 | 35 | 10   |   |   |  |
| new AEM90-A01236-D26-C25-L160-Z04-H                | ●                      | 26  | 4    | 25   | 160 | 35 | 10   | A0.1236..                                 | 3008-M2.5x6                                 | 82-T08                                     |
| AEM90-A01236-D32-W32-L150-Z04                      | ●                      | 32  | 4    | 32   | 150 | 50 | 10   |   |   |  |
| new AEM90-A01236-D32-C32-L160-Z05-H                | ●                      | 32  | 5    | 32   | 160 | 50 | 10   |   |   |  |

R: Sağ / Right / Rechtsl L: Sol / Left / Links

● Stokta / In Stock / Auf Lager ○ Stokta Yok / Non Stock Item / Kein Lagerartikel, Lieferzeit auf Anfrage  
MTSBH Ucuna Uygundur. / Compatible with MTSBH Insert. / Kompatibel mit MTSBH Wendeplatten.

Sipariş Örneği/Ordering Example/Bestellbeispiel

1 ad./pcs./stück AEM90-AP16P-D25-W25-L100-Z02-H

Kesme Hesabı : S 367 / Cutting Calculation : P 367 / Schnittberechnung : P 367

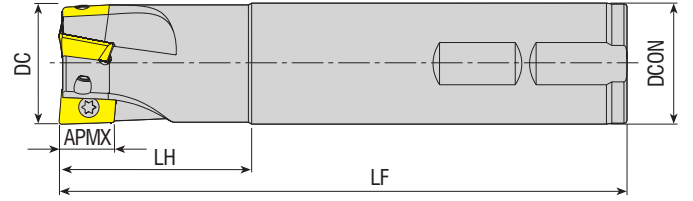

| Takım Kodu<br>Ordering Code<br>Bestell-Bezeichnung | Stok<br>Stock<br>Lager | Takım Ölçüleri (mm)<br>Dimension (mm)<br>Abmessung (mm) |      |      |     |    |      | Kesici Uç<br>Insert<br>Wendeschneidplatte | Yedek Parçaları / Spare Parts / Ersatzteile |  |
|--|------------------------|---|------|------|-----|----|------|---|---|--|
|  |                        | DC  | ZEFP | DCON | LF  | LH | APMX |   | Sıkma Vidası<br>Screw<br>Schraube           | Tork Anahtar<br>Torx Key<br>Torx-Schlüssel |
| AEM90-AX0602-D10-C09-L120-Z02                      | ●                      | 10  | 2    | 9    | 120 | 20 | 5.7  | AX.. 0602                                 | 3006-M1.8x4                                 | 82-T06                                     |
| AEM90-AX0602-D10-C10-L080-Z02                      | ●                      | 10  | 2    | 10   | 80  | 20 | 5.7  |   |   |  |
| AEM90-AX0602-D10-C10-L120-Z02                      | ●                      | 10  | 2    | 10   | 120 | 20 | 5.7  |   |   |  |
| AEM90-AX0602-D12-C11-L120-Z02                      | ●                      | 12  | 2    | 11   | 120 | 20 | 5.7  |   |   |  |
| AEM90-AX0602-D12-C12-L080-Z02                      | ●                      | 12  | 2    | 12   | 80  | 20 | 5.7  |   |   |  |
| AEM90-AX0602-D12-C12-L120-Z02                      | ●                      | 12  | 2    | 12   | 120 | 20 | 5.7  |   |   |  |
| AEM90-AX0602-D14-C12-L120-Z03                      | ●                      | 14  | 3    | 12   | 120 | 20 | 5.7  |   |   |  |
| AEM90-AX0602-D16-W16-L120-Z04-H                    | ●                      | 16  | 4    | 16   | 120 | 20 | 5.7  |   |   |  |
| AEM90-AX0602-D16-W16-L150-Z04-H                    | ●                      | 16  | 4    | 16   | 150 | 20 | 5.7  |   |   |  |
| AEM90-AX0602-D20-W20-L120-Z05-H                    | ●                      | 20  | 5    | 20   | 120 | 25 | 5.7  |   |   |  |
| AEM90-AX0602-D20-W20-L150-Z05-H                    | ●                      | 20  | 5    | 20   | 150 | 25 | 5.7  |   |   |  |
| AEM90-AX0903-D16-C16-L120-Z02                      | ●                      | 16  | 2    | 16   | 120 | 30 | 8.8  | AX.. 0903                                 | 3008-M2.5x5                                 | 82-T08                                     |
| AEM90-AX0903-D16-C16-L180-Z02                      | ●                      | 16  | 2    | 16   | 180 | 30 | 8.8  |   |   |  |
| AEM90-AX0903-D17-C16-L120-Z02                      | ●                      | 17  | 2    | 16   | 120 | 25 | 8.8  |   |   |  |
| AEM90-AX0903-D17-C16-L180-Z02                      | ●                      | 17  | 2    | 16   | 180 | 25 | 8.8  |   |   |  |
| AEM90-AX0903-D20-C20-L120-Z03                      | ●                      | 20  | 3    | 20   | 120 | 30 | 8.8  |   |   |  |
| AEM90-AX0903-D20-C20-L200-Z02                      | ●                      | 20  | 2    | 20   | 200 | 30 | 8.8  |   |   |  |
| AEM90-AX0903-D21-C20-L120-Z03                      | ●                      | 21  | 3    | 20   | 120 | 25 | 8.8  |   |   |  |
| AEM90-AX0903-D21-C20-L200-Z02                      | ●                      | 21  | 2    | 20   | 200 | 25 | 8.8  |   |   |  |
| AEM90-AX0903-D25-C25-L150-Z03                      | ●                      | 25  | 3    | 25   | 150 | 30 | 8.8  |   |   |  |
| AEM90-AX0903-D25-C25-L250-Z02                      | ●                      | 25  | 2    | 25   | 250 | 40 | 8.8  |   |   |  |
| AEM90-AX0903-D26-C25-L150-Z03                      | ●                      | 26  | 3    | 25   | 150 | 30 | 8.8  |   |   |  |

R: Sağ / Right / Rechts/ L: Sol / Left / Links

● Stokta / In Stock / Auf Lager ○ Stokta Yok / Non Stock Item / Kein Lagerartikel, Lieferzeit auf Anfrage  
TGTC Ucuna Uygunudur. / Compatible with TGTC Insert. / Kompatibel mit TGTC Wendeplatten.

Sipariş Örneği/Ordering Example/Bestellbeispiel

1 ad./pcs./stück AEM90-AX0602-D10-C09-L120-Z02

Kesme Hesabı : S 377/ Cutting Calculation : P 377 / Schnittberechnung : P 377



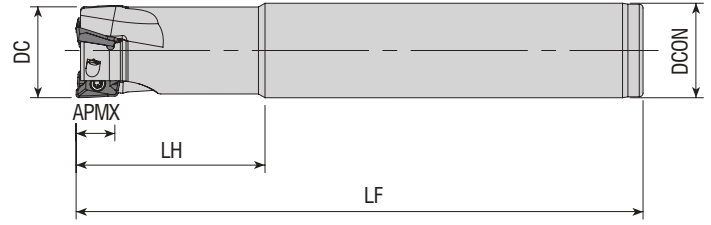

| Takım Kodu<br>Ordering Code<br>Bestell-Bezeichnung | Stok<br>Stock<br>Lager | Takım Ölçüleri (mm)<br>Dimension (mm)<br>Abmessung (mm) |      |      |     |    |      | Kesici Uç<br>Insert<br>Wendeschneidplatte | Yedek Parçaları / Spare Parts / Ersatzteile |  |           |        |
|--|------------------------|---|------|------|-----|----|------|---|---|--|-----------|--------|
|  |                        | DC  | ZEFP | DCON | LF  | LH | APMX |   | Sıkma Vidası<br>Screw<br>Schraube           | Tork Anahtar<br>Torx Key<br>Torx-Schlüssel |           |        |
| AEM90-AX1235-D16-C14-L120-Z02-H                    | ●                      | 16  | 2    | 14   | 120 | 25 | 10   | AX.T 1235..                               | 3008-M3x6                                   | 82-T08                                     |           |        |
| AEM90-AX1235-D16-C15-L145-Z02-H                    | ●                      | 16  | 2    | 15   | 145 | 30 | 10   |   | 3108-M3x6                                   |  |           |        |
| AEM90-AX1235-D16-C16-L100-Z02-H                    | ●                      | 16  | 2    | 16   | 100 | 30 | 10   |   | 3008-M3x6                                   |  |           |        |
| AEM90-AX1235-D16-C16-L140-Z02-H                    | ●                      | 16  | 2    | 16   | 140 | 30 | 10   |   | 3108-M3x6                                   |  |           |        |
| AEM90-AX1235-D16-C16-L145-Z02-H                    | ●                      | 16  | 2    | 16   | 145 | 30 | 10   |   | 3008-M3x6                                   |  |           |        |
| AEM90-AX1235-D16-C16-L150-Z02                      | ●                      | 16  | 2    | 16   | 150 | 30 | 10   |   | 3108-M3x6                                   |  |           |        |
| AEM90-AX1235-D20-C19-L150-Z02-H                    | ●                      | 20  | 2    | 19   | 150 | 40 | 10   |   | 3008-M3x6                                   |  |           |        |
| AEM90-AX1235-D20-C20-L110-Z03-H                    | ●                      | 20  | 3    | 20   | 110 | 40 | 10   |   | 3108-M3x6                                   |  |           |        |
| AEM90-AX1235-D20-C20-L150-Z02                      | ●                      | 20  | 2    | 20   | 150 | 40 | 10   |   | 3008-M3x6                                   |  |           |        |
| AEM90-AX1235-D20-C20-L150-Z02-H                    | ●                      | 20  | 2    | 20   | 150 | 40 | 10   |   | 3108-M3x6                                   |  |           |        |
| AEM90-AX1235-D20-C20-L150-Z03                      | ●                      | 20  | 3    | 20   | 150 | 40 | 10   |   | 3008-M3x6                                   |  |           |        |
| AEM90-AX1235-D25-C20-L120-Z04-H                    | ●                      | 25  | 4    | 20   | 120 | 30 | 10   |   | 3108-M3x6                                   |  |           |        |
| AEM90-AX1235-D25-C20-L150-Z04-H                    | ●                      | 25  | 4    | 20   | 150 | 30 | 10   |   | 3008-M3x6                                   |  |           |        |
| AEM90-AX1235-D25-C24-L170-Z02-H                    | ●                      | 25  | 2    | 24   | 170 | 50 | 10   |   | 3108-M3x6                                   |  |           |        |
| AEM90-AX1235-D25-C25-L120-Z04-H                    | ●                      | 25  | 4    | 25   | 120 | 40 | 10   |   | 3008-M3x6                                   |  |           |        |
| AEM90-AX1235-D25-C25-L150-Z03                      | ●                      | 25  | 3    | 25   | 150 | 50 | 10   |   | 3108-M3x6                                   |  |           |        |
| AEM90-AX1235-D25-C25-L170-Z02-H                    | ●                      | 25  | 2    | 25   | 170 | 50 | 10   |   | 3008-M3x6                                   |  |           |        |
| AEM90-AX1235-D25-W25-L100-Z04-H                    | ●                      | 25  | 4    | 25   | 100 | 30 | 10   |   | 3108-M3x6                                   |  |           |        |
| AEM90-AX1235-D32-C32-L130-Z05-H                    | ●                      | 32  | 5    | 32   | 130 | 40 | 10   |   | AX.T 1705..                                 |  | 4015-M4x9 | 80-T15 |
| AEM90-AX1235-D32-C32-L180-Z02-H                    | ●                      | 32  | 2    | 32   | 180 | 50 | 10   |   |   |  |           |        |
| AEM90-AX1705-D25-C25-L150-Z02                      | ●                      | 25  | 2    | 25   | 150 | 50 | 14   |   |   |  |           |        |
| AEM90-AX1705-D28-W25-L115-Z02-H                    | ●                      | 28  | 2    | 25   | 115 | 35 | 14   |   |   |  |           |        |
| AEM90-AX1705-D32-C32-L150-Z03                      | ●                      | 32  | 3    | 32   | 150 | 50 | 14   |   |   |  |           |        |
| AEM90-AX1705-D32-C32-L180-Z02-H                    | ●                      | 32  | 2    | 32   | 180 | 50 | 14   |   |   |  |           |        |





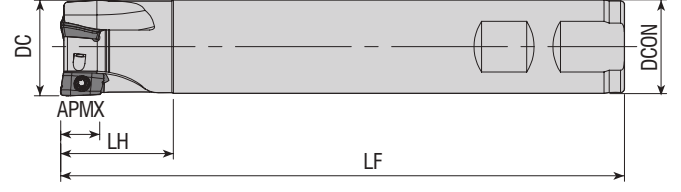

R: Sağ / Right / Rechts/ L: Sol / Left / Links

● Stokta / In Stock / Auf Lager ○ Stokta Yok / Non Stock Item / Kein Lagerartikel, Lieferzeit auf Anfrage  
SMTM Ucuna Uygunudur. / Compatible with SMTM Insert / Kompatibel mit SMTM Wendepplatten.

Sipariş Örneği/Ordering Example/Bestellbeispiel  
1 ad./pcs./stück AEM90-AX1235-D16-C14-L120-Z02-H  
Kesme Hesabı : S 377/ Cutting Calculation : P 377 / Schnittberechnung : P 377

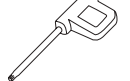
KAPR=90°

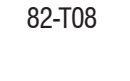

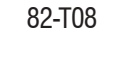
| Takım Kodu<br>Ordering Code<br>Bestell-Bezeichnung | Stok<br>Stock<br>Lager | Takım Ölçüleri (mm)<br>Dimension (mm)<br>Abmessung (mm) |      |      |     |     |      | Kesici Uç<br>Insert<br>Wendeschneidplatte   | Yedek Parçaları / Spare Parts / Ersatzteile   |   |
|--|------------------------|---|------|------|-----|-----|------|---|---|---|
|  |                        | DC  | ZEFP | DCON | LF  | LH  | APMX |   | Sıkma Vidası<br>Screw<br>Schraube   | Tork Anahtar<br>Torx Key<br>Torx-Schlüssel  |
| AEM90-AZ11-D12-W16-L90-Z01                         | ●                      | 12  | 1    | 16   | 90  | 30  | 11   |    |    |    |
| AEM90-AZ11-D16-C16-L200-Z02                        | ●                      | 16  | 2    | 16   | 200 | 100 | 11   |   |   |   |
| AEM90-AZ11-D16-W15-L170-Z02                        | ●                      | 16  | 2    | 15   | 170 | 50  | 11   |   |   |   |
| AEM90-AZ11-D16-W16-L100-Z02                        | ●                      | 16  | 2    | 16   | 100 | 35  | 11   |   |   |   |
| AEM90-AZ11-D16-W16-L150-Z02                        | ●                      | 16  | 2    | 16   | 150 | 50  | 11   |   |   |   |
| AEM90-AZ11-D17-C16-L150-Z02                        | ●                      | 17  | 2    | 16   | 150 | 30  | 11   |   |   |   |
| AEM90-AZ11-D17-C16-L180-Z02                        | ●                      | 17  | 2    | 16   | 180 | 50  | 11   |   |   |   |
| AEM90-AZ11-D17-W16-L100-Z02                        | ●                      | 17  | 2    | 16   | 100 | 30  | 11   |   |   |   |
| AEM90-AZ11-D18-W16-L120-Z02                        | ●                      | 18  | 2    | 16   | 120 | 18  | 11   |   |  |  |
| AEM90-AZ11-D20-C20-L200-Z03                        | ●                      | 20  | 3    | 20   | 200 | 100 | 11   |   |   |   |
| AEM90-AZ11-D20-W19-L170-Z03                        | ●                      | 20  | 3    | 19   | 170 | 50  | 11   |   |   |   |
| AEM90-AZ11-D20-W20-L110-Z02                        | ●                      | 20  | 2    | 20   | 110 | 35  | 11   |   |   |   |
| AEM90-AZ11-D21-C20-L150-Z03                        | ●                      | 21  | 3    | 20   | 150 | 30  | 11   |   |   |   |
| AEM90-AZ11-D21-C20-L180-Z03                        | ●                      | 21  | 3    | 20   | 180 | 50  | 11   |   |   |   |
| AEM90-AZ11-D21-W20-L110-Z03                        | ●                      | 21  | 3    | 20   | 110 | 35  | 11   |   |   |   |
| AEM90-AZ11-D22-C20-L150-Z02                        | ●                      | 22  | 2    | 20   | 150 | 30  | 11   |   |   |   |
| AEM90-AZ11-D25-C24-L180-Z04                        | ●                      | 25  | 4    | 24   | 180 | 50  | 11   |  |  |  |
| AEM90-AZ11-D25-W25-L110-Z04                        | ●                      | 25  | 4    | 25   | 110 | 40  | 11   |   |   |   |
| AEM90-AZ11-D26-C25-L250-Z02                        | ●                      | 26  | 2    | 25   | 250 | 50  | 11   |   |   |   |
| AEM90-AZ11-D26-W25-L120-Z03                        | ●                      | 26  | 3    | 25   | 120 | 30  | 11   |   |   |   |
| AEM90-AZ11-D26-W25-L120-Z04                        | ●                      | 26  | 4    | 25   | 120 | 40  | 11   |   |   |   |
| AEM90-AZ11-D28-C25-L180-Z03                        | ●                      | 28  | 3    | 25   | 180 | 50  | 11   |   |   |   |
| AEM90-AZ11-D28-C25-L250-Z02                        | ●                      | 28  | 2    | 25   | 250 | 50  | 11   |   |   |   |
| AEM90-AZ11-D33-W32-L130-Z04                        | ●                      | 33  | 4    | 32   | 130 | 50  | 11   |   |   |   |

R: Sağ / Right / Rechtsl L: Sol / Left / Links

● Stokta / In Stock / Auf Lager ○ Stokta Yok / Non Stock Item / Kein Lagerartikel, Lieferzeit auf Anfrage  
ZCC Ucuna Uygunudur. / Compatible with ZCC Insert. / Kompatibel mit ZCC Wendeplatten.

Sipariş Örneği/Ordering Example/Bestellbeispiel

1 ad./pcs./stück AEM90-AZ11-D12-W16-L90-Z01

Kesme Hesabı : S 377/ Cutting Calculation : P 377 / Schnittberechnung : P 377

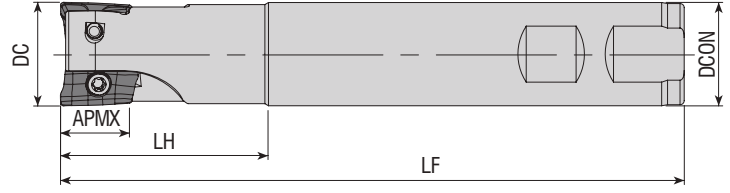

**Takım Kodu**  
**Ordering Code**  
**Bestell-Bezeichnung**

Stok  
Stock  
Lager

Takım Ölçüleri (mm)  
Dimension (mm)  
Abmessung (mm)

Kesici Uç  
Insert  
Wendeschneidplatte

Yedek Parçaları / Spare Parts / Ersatzteile

Sıkma Vidası  
Screw  
Schraube

Tork Anahtar  
Torx Key  
Torx-Schlüssel

| Takım Kodu<br>Ordering Code<br>Bestell-Bezeichnung | Stok<br>Stock<br>Lager | DC | ZEFP | DCON | LF  | LH  | APMX | Kesici Uç<br>Insert<br>Wendeschneidplatte | Sıkma Vidası<br>Screw<br>Schraube | Tork Anahtar<br>Torx Key<br>Torx-Schlüssel |
|--|------------------------|----|------|------|-----|-----|------|---|-----------------------------------|--|
| AEM90-BD11T3-D16-C16-L100-Z02-H                    | ●                      | 16 | 2    | 16   | 100 | 30  | 10   | BDMT 11T3..                               | 3008-M2.5x5                       |  |
| AEM90-BD11T3-D16-W16-L100-Z02-H                    | ●                      | 16 | 2    | 16   | 100 | 30  | 10   |   |                                   |  |
| AEM90-BD11T3-D16-W16-L150-Z02                      | ●                      | 16 | 2    | 16   | 150 | 50  | 10   |   |                                   |  |
| AEM90-BD11T3-D16-C16-L160-Z02-H                    | ●                      | 16 | 2    | 16   | 160 | 60  | 10   |   |                                   |  |
| AEM90-BD11T3-D16-C15-L180-Z02                      | ●                      | 16 | 2    | 15   | 180 | 50  | 10   |   |                                   |  |
| AEM90-BD11T3-D17-W16-L150-Z02                      | ●                      | 17 | 2    | 16   | 150 | 25  | 10   |   |                                   |  |
| AEM90-BD11T3-D17-C16-L180-Z02                      | ●                      | 17 | 2    | 16   | 180 | 25  | 10   |   |                                   |  |
| AEM90-BD11T3-D18-W16-L100-Z02                      | ●                      | 18 | 2    | 16   | 100 | 25  | 10   |   |                                   |  |
| AEM90-BD11T3-D18-W16-L100-Z02-H                    | ●                      | 18 | 2    | 16   | 100 | 25  | 10   |   |                                   |  |
| new AEM90-BD11T3-D20-W16-L61-Z03                   | ●                      | 20 | 3    | 16   | 61  | 26  | 10   |   |                                   |  |
| AEM90-BD11T3-D20-W20-L81-Z03-H                     | ●                      | 20 | 3    | 20   | 81  | 30  | 10   |   |                                   |  |
| AEM90-BD11T3-D20-W20-L100-Z02-H                    | ●                      | 20 | 2    | 20   | 100 | 30  | 10   |   |                                   |  |
| AEM90-BD11T3-D20-W20-L100-Z03-H                    | ●                      | 20 | 3    | 20   | 100 | 30  | 10   |   |                                   |  |
| AEM90-BD11T3-D20-C20-L110-Z03-H                    | ●                      | 20 | 3    | 20   | 110 | 30  | 10   |   |                                   |  |
| AEM90-BD11T3-D20-W20-L150-Z02                      | ●                      | 20 | 2    | 20   | 150 | 50  | 10   |   |                                   |  |
| AEM90-BD11T3-D20-W20-L150-Z03                      | ●                      | 20 | 3    | 20   | 150 | 50  | 10   |   |                                   |  |
| AEM90-BD11T3-D20-W20-L150-Z03-H                    | ●                      | 20 | 3    | 20   | 150 | 50  | 10   |   |                                   |  |
| AEM90-BD11T3-D20-C20-L170-Z03-H                    | ●                      | 20 | 3    | 20   | 170 | 60  | 10   |   |                                   |  |
| AEM90-BD11T3-D21-W20-L150-Z03                      | ●                      | 21 | 3    | 20   | 150 | 25  | 10   |   |                                   |  |
| AEM90-BD11T3-D21-C20-L200-Z02                      | ●                      | 21 | 2    | 20   | 200 | 25  | 10   |   |                                   |  |
| AEM90-BD11T3-D22-W20-L090-Z02-H                    | ●                      | 22 | 2    | 20   | 90  | 25  | 10   |   |                                   |  |
| new AEM90-BD11T3-D22-W20-L100-Z03-H                | ●                      | 22 | 3    | 20   | 100 | 30  | 10   |   |                                   |  |
| AEM90-BD11T3-D25-W25-L100-Z03-H                    | ●                      | 25 | 3    | 25   | 100 | 30  | 10   |   |                                   |  |
| AEM90-BD11T3-D25-C20-L120-Z03-H                    | ●                      | 25 | 3    | 20   | 120 | 30  | 10   |   |                                   |  |
| AEM90-BD11T3-D25-C25-L120-Z03-H                    | ●                      | 25 | 3    | 25   | 120 | 30  | 10   |   |                                   |  |
| AEM90-BD11T3-D25-W25-L150-Z03                      | ●                      | 25 | 3    | 25   | 150 | 50  | 10   |   |                                   |  |
| AEM90-BD11T3-D26-W25-L150-Z03                      | ●                      | 26 | 3    | 25   | 150 | 35  | 10   |   |                                   |  |
| AEM90-BD11T3-D26-C25-L250-Z02                      | ●                      | 26 | 2    | 25   | 250 | 35  | 10   |   |                                   |  |
| AEM90-BD11T3-D32-W32-L110-Z04-H                    | ●                      | 32 | 4    | 32   | 110 | 40  | 10   |   |                                   |  |
| AEM90-BD11T3-D32-C32-L130-Z04-H                    | ●                      | 32 | 4    | 32   | 130 | 40  | 10   |   |                                   |  |
| AEM90-BD11T3-D32-W32-L150-Z04                      | ●                      | 32 | 4    | 32   | 150 | 50  | 10   |   |                                   |  |
| AEM90-BD11T3-D40-W32-L110-Z04-H                    | ●                      | 40 | 4    | 32   | 110 | 35  | 10   |   |                                   |  |
| AEM90-BD1704-D25-W25-L100-Z02-H                    | ●                      | 25 | 2    | 25   | 100 | 35  | 15.7 | BDMT 1704..                               | 4015-M4x8                         | 80-T15                                     |
| AEM90-BD1704-D25-W25-L150-Z02                      | ●                      | 25 | 2    | 25   | 150 | 50  | 15.7 |   |                                   |  |
| AEM90-BD1704-D25-C25-L210-Z02-H                    | ●                      | 25 | 2    | 25   | 210 | 100 | 15.7 |   |                                   |  |
| AEM90-BD1704-D32-W32-L110-Z03-H                    | ●                      | 32 | 3    | 32   | 110 | 40  | 15.7 |   |                                   |  |
| AEM90-BD1704-D32-C32-L130-Z03-H                    | ●                      | 32 | 3    | 32   | 130 | 40  | 15.7 |   |                                   |  |
| AEM90-BD1704-D32-W32-L130-Z03-H                    | ●                      | 32 | 3    | 32   | 130 | 40  | 15.7 |   |                                   |  |
| AEM90-BD1704-D32-W32-L150-Z03                      | ●                      | 32 | 3    | 32   | 150 | 50  | 15.7 |   |                                   |  |
| AEM90-BD1704-D40-W32-L110-Z04-H                    | ●                      | 40 | 4    | 32   | 110 | 40  | 15.7 |   |                                   |  |
| AEM90-BD1704-D40-W32-L150-Z04                      | ●                      | 40 | 4    | 32   | 150 | 40  | 15.7 |   |                                   |  |

R: Sağ / Right / Rechts/ L: Sol / Left / Links

● Stokta / In Stock / Auf Lager ○ Stokta Yok / Non Stock Item / Kein Lagerartikel, Lieferzeit auf Anfrage

KYCR Ucuna Uygundur. / Compatible with KYCR Insert. / Kompatibel mit KYCR Wendeplatten.

Sipariş Örneği/Ordering Example/Bestellbeispiel

1 ad./pcs./stück AEM90-BD11T3-D16-C16-L100-Z02-H

Kesme Hesabı : S 367 / Cutting Calculation : P 367 / Schnittberechnung : P 367

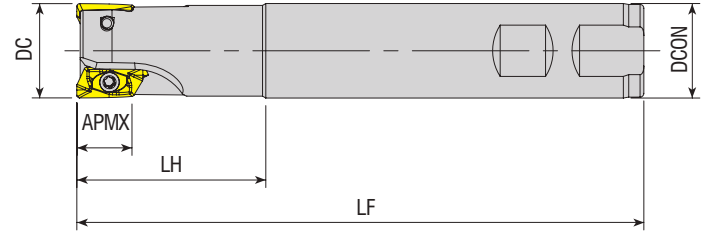

| Takım Kodu<br>Ordering Code<br>Bestell-Bezeichnung | Stok<br>Stock<br>Lager | Takım Ölçüleri (mm)<br>Dimension (mm)<br>Abmessung (mm) |      |      |     |    |      | Kesici Uç<br>Insert<br>Wendeschneidplatte | Yedek Parçaları / Spare Parts / Ersatzteile |  |
|--|------------------------|---|------|------|-----|----|------|---|---|--|
|  |                        | DC  | ZEFP | DCON | LF  | LH | APMX |   | Sıkma Vidası<br>Screw<br>Schraube           | Tork Anahtar<br>Torx Key<br>Torx-Schlüssel |
| AEM90-ED10T3-D16-W16-L120-Z02                      | ●                      | 16  | 2    | 16   | 120 | 30 | 30   | EDPT 10T3..                               | 3008-M2.5x5                                 | 82-T08                                     |
| AEM90-ED10T3-D20-W20-L120-Z02                      | ●                      | 20  | 2    | 20   | 120 | 30 | 30   |   | 3008-M2.5x6                                 |  |
| AEM90-ED1404-D20-W20-L150-Z02                      | ●                      | 20  | 2    | 20   | 150 | 50 | 14.5 | EDPT 1404..                               | 3008-M3x6                                   |  |
| AEM90-ED1404-D25-W25-L150-Z02                      | ●                      | 25  | 2    | 25   | 150 | 50 | 14.5 |   |   |  |
| AEM90-ED1404-D30-C25-L150-Z03                      | ●                      | 30  | 3    | 25   | 150 | 50 | 14.5 |   |   |  |

KNMTL Ucuna Uygunudur. / Compatible with KNMTL Insert. / Kompatibel mit KNMTL

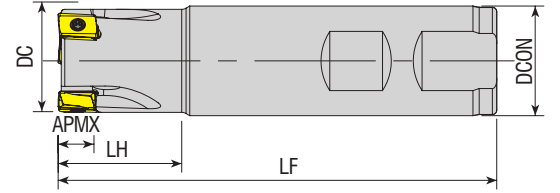

| Takım Kodu<br>Ordering Code<br>Bestell-Bezeichnung | Stok<br>Stock<br>Lager | Takım Ölçüleri (mm)<br>Dimension (mm)<br>Abmessung (mm) |      |      |     |    |      | Kesici Uç<br>Insert<br>Wendeschneidplatte | Yedek Parçaları / Spare Parts / Ersatzteile |  |
|--|------------------------|---|------|------|-----|----|------|---|---|--|
|  |                        | DC  | ZEFP | DCON | LF  | LH | APMX |   | Sıkma Vidası<br>Screw<br>Schraube           | Tork Anahtar<br>Torx Key<br>Torx-Schlüssel |
| AEM90-LN08-D16-W16-L100-Z02-H                      | ●                      | 16  | 2    | 16   | 100 | 28 | 8    | LNMT 0804..                               | 1707-U4-48x6                                | 82-T07                                     |
| AEM90-LN08-D16-W16-L150-Z02                        | ●                      | 16  | 2    | 16   | 150 | 40 | 8    |   | 1707-U4-48x6.5                              |  |
| AEM90-LN08-D20-W20-L100-Z03-H                      | ●                      | 20  | 3    | 20   | 100 | 28 | 8    |   | 1707-U4-48x8.2                              |  |
| AEM90-LN08-D25-W25-L100-Z03-H                      | ●                      | 25  | 3    | 25   | 100 | 30 | 8    |   |   |  |
| AEM90-LN08-D32-W32-L110-Z05-H                      | ●                      | 32  | 5    | 32   | 110 | 30 | 8    |   |   |  |
| <b>new</b> AEM90-LN1306-D32-W32-L150-Z03           | ●                      | 32  | 3    | 32   | 150 | 50 | 12.5 | LNMT 1306..                               | 4015-M4x11                                  | 80-T15                                     |
| <b>new</b> AEM90-LN1306-D36-C32-L110-Z03-H         | ●                      | 36  | 3    | 32   | 110 | 40 | 12.5 |   |   |  |

R: Sağ / Right / Rechts/ L: Sol / Left / Links

● Stokta / In Stock / Auf Lager ○ Stokta Yok / Non Stock Item / Kein Lagerartikel, Lieferzeit auf Anfrage  
ISCR Ucuna Uygunudur. / Compatible with ISCR Insert. / Kompatibel mit ISCR Wendeplatten.

Sipariş Örneği/Ordering Example/Bestellbeispiel

1 ad./pcs./stück AEM90-ED10T3-D16-W16-L120-Z02

Kesme Hesabı : S 377/ Cutting Calculation : P 377 / Schnittberechnung : P 377

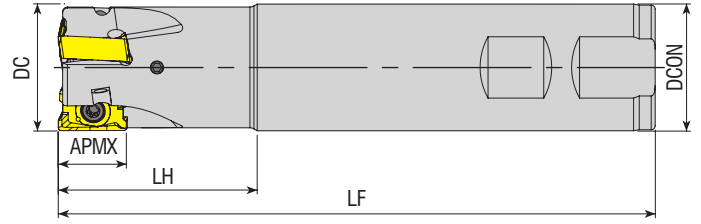

| Takım Kodu<br>Ordering Code<br>Bestell-Bezeichnung | Stok<br>Stock<br>Lager | Takım Ölçüleri (mm)<br>Dimension (mm)<br>Abmessung (mm) |      |      |     |    |      | Kesici Uç<br>Insert<br>Wendeschneidplatte | Yedek Parçaları / Spare Parts / Ersatzteile |  |  |
|--|------------------------|---|------|------|-----|----|------|---|---|--|--|
|  |                        | DC  | ZEFP | DCON | LF  | LH | APMX |   | Sıkma Vidası<br>Screw<br>Schraube           | Tork Anahtar<br>Torx Key<br>Torx-Schlüssel |  |
| AEM90-LN15T6-D25-W25-L150-Z02-H                    | ●                      | 25  | 2    | 25   | 150 | 50 | 15.5 | LNGU 15T6..                               | 4015-M4x12                                  | 80-T15                                     |  |
| AEM90-LN15T6-D32-W32-L150-Z03-H                    | ●                      | 32  | 3    | 32   | 150 | 50 | 15.5 |   |   |  |  |
| AEM90-LN15T6-D40-W32-L150-Z03-H                    | ●                      | 40  | 3    | 32   | 150 | 40 | 15.5 |   |   |  |  |

KNMTL Ucuna Uygunur. / Compatible with KNMTL Insert. / Kompatibel mit KNMTL Wendeplatten.

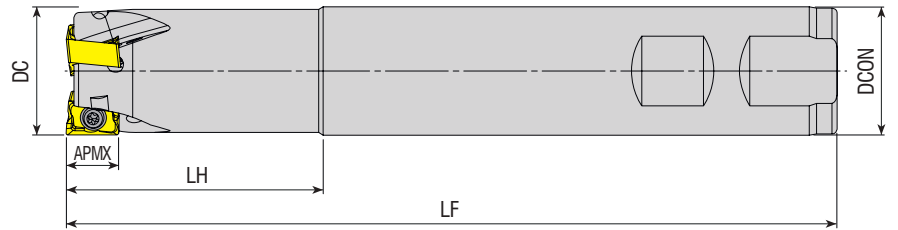

| Takım Kodu<br>Ordering Code<br>Bestell-Bezeichnung | Stok<br>Stock<br>Lager | Takım Ölçüleri (mm)<br>Dimension (mm)<br>Abmessung (mm) |      |      |     |    |      | Kesici Uç<br>Insert<br>Wendeschneidplatte | Yedek Parçaları / Spare Parts / Ersatzteile |  |  |
|--|------------------------|---|------|------|-----|----|------|---|---|--|--|
|  |                        | DC  | ZEFP | DCON | LF  | LH | APMX |   | Sıkma Vidası<br>Screw<br>Schraube           | Tork Anahtar<br>Torx Key<br>Torx-Schlüssel |  |
| AEM90-LN1006-D16-W16-L120-Z01-H                    | ●                      | 16  | 1    | 16   | 120 | 30 | 9    | LN.X 1006..                               | 4010-M3x8                                   | 82-T10                                     |  |
| AEM90-LN1006-D16-W16-L150-Z01                      | ●                      | 16  | 1    | 16   | 150 | 50 | 9    |   |   |  |  |
| AEM90-LN1006-D18-W16-L120-Z02-H                    | ●                      | 18  | 2    | 16   | 120 | 30 | 9    |   |   |  |  |
| AEM90-LN1006-D20-W20-L120-Z02-H                    | ●                      | 20  | 2    | 20   | 120 | 30 | 9    |   |   |  |  |
| AEM90-LN1006-D20-W20-L150-Z02                      | ●                      | 20  | 2    | 20   | 150 | 50 | 9    |   |   |  |  |
| AEM90-LN1006-D25-W25-L120-Z03-H                    | ●                      | 25  | 3    | 25   | 120 | 30 | 9    |   |   |  |  |
| AEM90-LN1006-D25-W25-L150-Z03                      | ●                      | 25  | 3    | 25   | 150 | 50 | 9    |   |   |  |  |
| AEM90-LN1006-D32-W32-L120-Z04-H                    | ●                      | 32  | 4    | 32   | 120 | 30 | 9    |   |   |  |  |
| AEM90-LN1006-D32-W32-L150-Z04                      | ●                      | 32  | 4    | 32   | 150 | 50 | 9    |   |   |  |  |

R: Sağ / Right / Rechts/ L: Sol / Left / Links

● Stokta / In Stock / Auf Lager ○ Stokta Yok / Non Stock Item / Kein Lagerartikel, Lieferzeit auf Anfrage  
KRYL Ucuna Uygunur. / Compatible with KRYL Insert. / Kompatibel mit KRYL Wendeplatten.

Sipariş Örneği/Ordering Example/Bestellbeispiel  
1 ad./pcs./stück AEM90-LN15T6-D25-W25-L150-Z02-H  
Kesme Hesabı : S 377/ Cutting Calculation : P 377 / Schnittberechnung : P 377

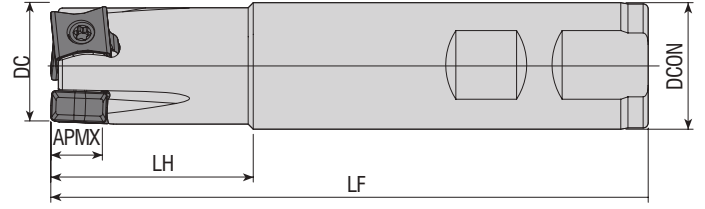

| Takım Kodu<br>Ordering Code<br>Bestell-Bezeichnung | Stok<br>Stock<br>Lager | Takım Ölçüleri (mm)<br>Dimension (mm)<br>Abmessung (mm) |      |      |     |    |      | Kesici Uç<br>Insert<br>Wendeschneidplatte | Yedek Parçaları / Spare Parts / Ersatzteile |  |
|--|------------------------|---|------|------|-----|----|------|---|---|--|
|  |                        | DC  | ZEFP | DCON | LF  | LH | APMX |   | Sıkma Vidası<br>Screw<br>Schraube           | Tork Anahtar<br>Torx Key<br>Torx-Schlüssel |
| AEM90-LN1106-D25-W25-L150-Z03                      | ●                      | 25  | 3    | 25   | 150 | 40 | 10   | LNMT 1106..                               | 4015-M3.5x11                                | 80-T15                                     |
| AEM90-LN1106-D32-W32-L150-Z04                      | ●                      | 32  | 4    | 32   | 150 | 40 | 10   |   |   |  |
| AEM90-LN1106-D40-W32-L150-Z05                      | ●                      | 40  | 5    | 32   | 150 | 40 | 10   |   |   |  |

ISCR-XTC-GSC Ucuna Uygunudur. / Compatible with ISCR-XTC-GSC Insert. / Kompatibel mit ISCR-XTC-GSC Wendeschneidplatten.

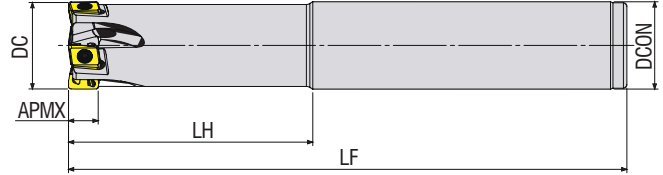

| Takım Kodu<br>Ordering Code<br>Bestell-Bezeichnung | Stok<br>Stock<br>Lager | Takım Ölçüleri (mm)<br>Dimension (mm)<br>Abmessung (mm) |      |      |     |    |      | Kesici Uç<br>Insert<br>Wendeschneidplatte | Yedek Parçaları / Spare Parts / Ersatzteile |  |
|--|------------------------|---|------|------|-----|----|------|---|---|--|
|  |                        | DC  | ZEFP | DCON | LF  | LH | APMX |   | Sıkma Vidası<br>Screw<br>Schraube           | Tork Anahtar<br>Torx Key<br>Torx-Schlüssel |
| AEM90-L009-D16-C16-L160-Z02-H                      | ○                      | 16  | 2    | 16   | 160 | 60 | 8    | LOGU 0904..                               | 1110-M3x8.5                                 | 82-T08                                     |
| AEM90-L009-D18-C16-L160-Z02-H                      | ○                      | 18  | 2    | 16   | 160 | 25 | 8    |   |   |  |
| AEM90-L009-D20-C20-L160-Z03-H                      | ○                      | 20  | 3    | 20   | 160 | 60 | 8    |   |   |  |
| AEM90-L009-D20-W20-L100-Z03-H                      | ●                      | 20  | 3    | 20   | 100 | 30 | 8    |   |   |  |
| AEM90-L009-D22-C20-L160-Z03-H                      | ○                      | 22  | 3    | 20   | 160 | 30 | 8    |   |   |  |
| AEM90-L009-D25-C25-L160-Z04-H                      | ○                      | 25  | 4    | 25   | 160 | 70 | 8    |   |   |  |
| AEM90-L009-D25-W25-L091-Z03-H                      | ●                      | 25  | 3    | 25   | 91  | 30 | 8    |   |   |  |
| AEM90-L009-D32-C32-L160-Z05-H                      | ●                      | 32  | 5    | 32   | 160 | 70 | 8    |   |   |  |

R: Sağ / Right / Rechtsl L: Sol / Left / Links  
● Stokta / In Stock / Auf Lager ○ Stokta Yok / Non Stock Item / Kein Lagerartikel, Lieferzeit auf Anfrage  
MTSBH Ucuna Uygunudur. / Compatible with MTSBH Insert. / Kompatibel mit MTSBH Wendeschneidplatten.

Sipariş Örneği/Ordering Example/Bestellbeispiel  
1 ad./pcs./stück AEM90-LN1106-D25-W25-L150-Z03  
Kesme Hesabı : S 377 / Cutting Calculation : P 377 / Schnittberechnung : P 377





KAPR=90°

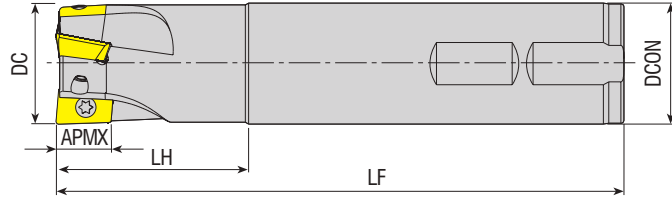

| Takım Kodu<br>Ordering Code<br>Bestell-Bezeichnung | Stok<br>Stock<br>Lager | Takım Ölçüleri (mm)<br>Dimension (mm)<br>Abmessung (mm) |      |      |     |    |      | Kesici Uç<br>Insert<br>Wendeschneidplatte | Yedek Parçaları / Spare Parts / Ersatzteile |  |             |
|--|------------------------|---|------|------|-----|----|------|---|---|--|-------------|
|  |                        | DC  | ZEFP | DCON | LF  | LH | APMX |   | Sıkma Vidası<br>Screw<br>Schraube           | Tork Anahtar<br>Torx Key<br>Torx-Schlüssel |             |
| AEM90-L010-D16-W16-L100-Z02                        | ●                      | 16  | 2    | 16   | 100 | 30 | 10   | LOMU 1004..                               |   |  |             |
| AEM90-L010-D16-W16-L160-Z02                        | ●                      | 16  | 2    | 16   | 160 | 50 | 10   |   |   |  | 1108-M3x6   |
| AEM90-L010-D20-W20-L130-Z03                        | ●                      | 20  | 3    | 20   | 130 | 40 | 10   |   |   |  | 1108-M3x6.8 |
| AEM90-L010-D25-W25-L150-Z03                        | ●                      | 25  | 3    | 25   | 150 | 50 | 10   |   |   |  |             |
| AEM90-L010-D32-W32-L150-Z04                        | ●                      | 32  | 4    | 32   | 150 | 50 | 10   |   |   |  |             |

KYCR Ucuna Uygundur. / Compatible with KYCR Insert. / Kompatibel mit KYCR Wendeplatten.

KAPR=90°

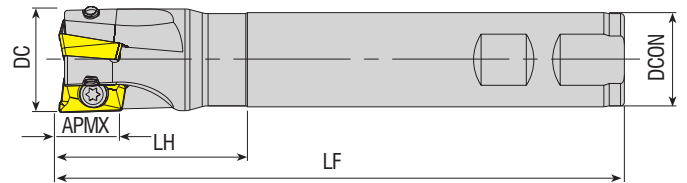

| Takım Kodu<br>Ordering Code<br>Bestell-Bezeichnung | Stok<br>Stock<br>Lager | Takım Ölçüleri (mm)<br>Dimension (mm)<br>Abmessung (mm) |      |      |     |    |      | Kesici Uç<br>Insert<br>Wendeschneidplatte | Yedek Parçaları / Spare Parts / Ersatzteile |  |
|--|------------------------|---|------|------|-----|----|------|---|---|--|
|  |                        | DC  | ZEFP | DCON | LF  | LH | APMX |   | Sıkma Vidası<br>Screw<br>Schraube           | Tork Anahtar<br>Torx Key<br>Torx-Schlüssel |
| AEM90-R390.11-D12-W12-L100-Z01                     | ●                      | 12  | 1    | 12   | 100 | 25 | 10   | R390-11T3..                               |   |  |
| AEM90-R390.11-D16-W16-L100-Z02-H                   | ●                      | 16  | 2    | 16   | 100 | 30 | 10   |   |   |  |
| AEM90-R390.11-D16-W16-L150-Z02                     | ●                      | 16  | 2    | 16   | 150 | 50 | 10   |   |   |  |
| AEM90-R390.11-D16-W16-L150-Z02-H                   | ●                      | 16  | 2    | 16   | 150 | 50 | 10   |   |   |  |
| AEM90-R390.11-D20-W20-L090-Z02-H                   | ●                      | 20  | 2    | 20   | 90  | 30 | 10   |   |   |  |
| AEM90-R390.11-D20-W20-L100-Z03-H                   | ●                      | 20  | 3    | 20   | 100 | 30 | 10   |   |   |  |
| AEM90-R390.11-D20-W20-L150-Z03                     | ●                      | 20  | 3    | 20   | 150 | 50 | 10   |   |   |  |
| AEM90-R390.11-D20-W20-L150-Z03-H                   | ●                      | 20  | 3    | 20   | 150 | 50 | 10   |   |   |  |
| AEM90-R390.11-D20-C20-L150-Z03                     | ●                      | 20  | 3    | 20   | 150 | 30 | 10   |   |   |  |
| AEM90-R390.11-D22-W20-L090-Z02-H                   | ●                      | 22  | 2    | 20   | 90  | 30 | 10   |   |   |  |
| AEM90-R390.11-D25-C20-L150-Z03                     | ●                      | 25  | 3    | 20   | 150 | 40 | 10   |   |   |  |
| AEM90-R390.11-D25-W25-L100-Z03-H                   | ●                      | 25  | 3    | 25   | 100 | 30 | 10   |   |   |  |
| AEM90-R390.11-D25-W25-L150-Z03                     | ●                      | 25  | 3    | 25   | 150 | 50 | 10   |   |   |  |
| AEM90-R390.11-D25-W25-L150-Z03-H                   | ●                      | 25  | 3    | 25   | 150 | 50 | 10   |   |   |  |
| AEM90-R390.11-D30-W25-L150-Z04-H                   | ●                      | 30  | 4    | 25   | 150 | 30 | 10   |   |   |  |
| AEM90-R390.11-D32-C25-L200-Z03                     | ●                      | 32  | 3    | 25   | 200 | 40 | 10   |   |   |  |
| AEM90-R390.11-D32-W32-L150-Z05-H                   | ●                      | 32  | 5    | 32   | 150 | 50 | 10   |   |   |  |
| AEM90-R390.17-D25-W25-L150-Z02                     | ●                      | 25  | 2    | 25   | 150 | 50 | 15.4 | R390-1704..                               |   |  |
| AEM90-R390.17-D25-W25-L150-Z02-H                   | ●                      | 25  | 2    | 25   | 150 | 50 | 15.4 |   |   |  |
| AEM90-R390.17-D30-W25-L150-Z03                     | ●                      | 30  | 3    | 25   | 150 | 40 | 15.4 |   |   |  |
| AEM90-R390.17-D30-W25-L150-Z03-H                   | ●                      | 30  | 3    | 25   | 150 | 40 | 15.4 |   |   |  |
| AEM90-R390.17-D32-W32-L150-Z03-H                   | ●                      | 32  | 3    | 32   | 150 | 40 | 15.4 |   |   |  |
| AEM90-R390.18-D32-C32-L150-Z03                     | ●                      | 32  | 3    | 32   | 150 | 45 | 15.4 | R390-1806..                               |   |  |
| AEM90-R390.18-D40-C32-L150-Z04-H                   | ●                      | 40  | 4    | 32   | 150 | 40 | 15.4 |   |   |  |

R: Sağ / Right / Rechts! L: Sol / Left / Links

● Stokta / In Stock / Auf Lager ○ Stokta Yok / Non Stock Item / Kein Lagerartikel, Lieferzeit auf Anfrage  
SNDVK Ucuna Uygundur. / Compatible with SNDVK Insert. / Kompatibel mit SNDVK Wendeplatten.

Sipariş Örneği/Ordering Example/Bestellbeispiel

1 ad./pcs./stück AEM90-L010-D16-W16-L100-Z02

Kesme Hesabı : S 377/ Cutting Calculation : P 377 / Schnittberechnung : P 377

# S-SİSTEM YÜZEY PARMAK FREZELER

S-SYSTEM END MILLS

S-SYSTEM SCHAFTFRÄSER

KAPR=90°

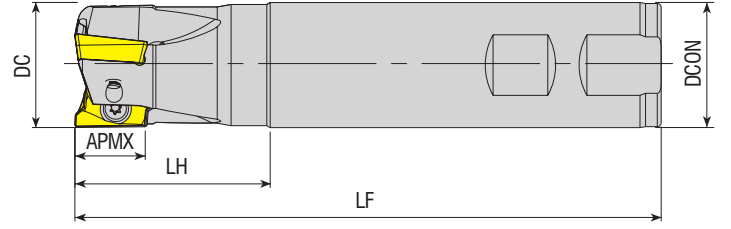

**Takım Kodu**  
**Ordering Code**  
**Bestell-Bezeichnung**

Stok  
Stock  
Lager

Takım Ölçüleri (mm)  
Dimension (mm)  
Abmessung (mm)

Kesici Uç  
Insert  
Wendeschneidplatte

Yedek Parçaları / Spare Parts / Ersatzteile

Sıkma Vidası  
Screw  
Schraube

Tork Anahtar  
Torx Key  
Torx-Schlüssel

| Takım Kodu<br>Ordering Code<br>Bestell-Bezeichnung | Stok<br>Stock<br>Lager | DC | ZEP | DCON | LF  | LH  | APMX | Kesici Uç<br>Insert<br>Wendeschneidplatte | Sıkma Vidası<br>Screw<br>Schraube | Tork Anahtar<br>Torx Key<br>Torx-Schlüssel |         |             |        |
|--|------------------------|----|-----|------|-----|-----|------|---|-----------------------------------|--|---------|-------------|--------|
| AEM90-RT07-D10-W10-L120-Z02                        | ●                      | 10 | 2   | 10   | 120 | 30  | 7    | RT 0702                                   | 3006-M2x4                         | 82-T06                                     |         |             |        |
| AEM90-RT07-D12-C12-L120-Z02                        | ●                      | 12 | 2   | 12   | 120 | 30  | 7    |   |                                   |  |         |             |        |
| AEM90-RT07-D12-W12-L120-Z02                        | ●                      | 12 | 2   | 12   | 120 | 30  | 7    |   |                                   |  |         |             |        |
| AEM90-RT07-D14-W12-L120-Z02                        | ●                      | 14 | 2   | 12   | 120 | 30  | 7    |   |                                   |  |         |             |        |
| AEM90-RT10-D16-C15-L160-Z02                        | ●                      | 16 | 2   | 15   | 160 | 30  | 10   |   |                                   |  | RT 1003 | 3008-M2.5x6 | 82-T08 |
| AEM90-RT10-D16-W16-L120-Z02-H                      | ●                      | 16 | 2   | 16   | 120 | 30  | 10   |   |                                   |  |         |             |        |
| AEM90-RT10-D16-W16-L150-Z02                        | ●                      | 16 | 2   | 16   | 150 | 30  | 10   |   |                                   |  |         |             |        |
| AEM90-RT10-D16-C16-L200-Z02                        | ●                      | 16 | 2   | 16   | 200 | 100 | 10   |   |                                   |  |         |             |        |
| AEM90-RT10-D17-W16-L160-Z02                        | ●                      | 17 | 2   | 16   | 160 | 30  | 10   |   |                                   |  |         |             |        |
| AEM90-RT10-D17-C16-L200-Z02                        | ●                      | 17 | 2   | 16   | 200 | 30  | 10   |   |                                   |  |         |             |        |
| AEM90-RT10-D18-W16-L120-Z02-H                      | ●                      | 18 | 2   | 16   | 120 | 30  | 10   |   |                                   |  |         |             |        |
| AEM90-RT10-D20-C19-L200-Z03                        | ●                      | 20 | 3   | 19   | 200 | 30  | 10   |   |                                   |  |         |             |        |
| AEM90-RT10-D20-C20-L110-Z03                        | ●                      | 20 | 3   | 20   | 110 | 30  | 10   |   |                                   |  |         |             |        |
| AEM90-RT10-D20-W20-L120-Z03-H                      | ●                      | 20 | 3   | 20   | 120 | 30  | 10   |   |                                   |  |         |             |        |
| AEM90-RT10-D20-W20-L150-Z03                        | ●                      | 20 | 3   | 20   | 150 | 50  | 10   |   |                                   |  |         |             |        |
| AEM90-RT10-D20-C20-L200-Z03                        | ●                      | 20 | 3   | 20   | 200 | 100 | 10   |   |                                   |  |         |             |        |
| AEM90-RT10-D21-W20-L200-Z03                        | ●                      | 21 | 3   | 20   | 200 | 30  | 10   |   |                                   |  |         |             |        |
| AEM90-RT10-D22-W20-L120-Z03-H                      | ●                      | 22 | 3   | 20   | 120 | 30  | 10   |   |                                   |  |         |             |        |
| AEM90-RT10-D22-C20-L150-Z03                        | ●                      | 22 | 3   | 20   | 150 | 30  | 10   |   |                                   |  |         |             |        |
| AEM90-RT10-D22-C20-L200-Z03                        | ●                      | 22 | 3   | 20   | 200 | 30  | 10   |   |                                   |  |         |             |        |
| AEM90-RT10-D25-W25-L120-Z04-H                      | ●                      | 25 | 4   | 25   | 120 | 40  | 10   | RT 1304                                   | 3008-M3x8                         |  |         |             |        |
| AEM90-RT10-D25-W25-L150-Z04                        | ●                      | 25 | 4   | 25   | 150 | 50  | 10   |   |                                   |  |         |             |        |
| AEM90-RT10-D25-C25-L200-Z04                        | ●                      | 25 | 4   | 25   | 200 | 100 | 10   |   |                                   |  |         |             |        |
| AEM90-RT10-D26-C25-L250-Z04                        | ●                      | 26 | 4   | 25   | 250 | 32  | 10   |   |                                   |  |         |             |        |
| AEM90-RT10-D32-W32-L120-Z05-H                      | ●                      | 32 | 5   | 32   | 120 | 50  | 10   |   |                                   |  |         |             |        |
| AEM90-RT10-D32-W32-L150-Z05                        | ●                      | 32 | 5   | 32   | 150 | 50  | 10   |   |                                   |  |         |             |        |
| AEM90-RT10-D32-C32-L200-Z05                        | ●                      | 32 | 5   | 32   | 200 | 100 | 10   |   |                                   |  |         |             |        |
| AEM90-RT10-D33-C32-L250-Z04                        | ●                      | 33 | 4   | 32   | 250 | 32  | 10   |   |                                   |  |         |             |        |
| AEM90-RT13-D32-C32-L250-Z04                        | ●                      | 32 | 4   | 32   | 250 | 50  | 13   |   |                                   |  |         |             |        |
| AEM90-RT16-D25-W25-L120-Z02-H                      | ●                      | 25 | 2   | 25   | 120 | 40  | 16   |   |                                   |  | RT 1606 | 4015-M4x9   | 80-T15 |
| AEM90-RT16-D25-W25-L150-Z02                        | ●                      | 25 | 2   | 25   | 150 | 50  | 16   |   |                                   |  |         |             |        |
| AEM90-RT16-D25-C25-L200-Z02                        | ●                      | 25 | 2   | 25   | 200 | 100 | 16   |   |                                   |  |         |             |        |
| AEM90-RT16-D32-W32-L120-Z03-H                      | ●                      | 32 | 3   | 32   | 120 | 50  | 16   |   |                                   |  |         |             |        |
| AEM90-RT16-D32-W32-L150-Z03                        | ●                      | 32 | 3   | 32   | 150 | 50  | 16   |   |                                   |  |         |             |        |
| AEM90-RT16-D32-C32-L200-Z03                        | ●                      | 32 | 3   | 32   | 200 | 100 | 16   |   |                                   |  |         |             |        |
| AEM90-RT16-D32-C32-L250-Z03                        | ●                      | 32 | 3   | 32   | 250 | 100 | 16   |   |                                   |  |         |             |        |
| AEM90-RT16-D32-C32-L270-Z03                        | ●                      | 32 | 3   | 32   | 270 | 100 | 16   |   |                                   |  |         |             |        |
| AEM90-RT16-D40-W32-L120-Z04-H                      | ●                      | 40 | 4   | 32   | 120 | 50  | 16   |   |                                   |  |         |             |        |
| AEM90-RT16-D40-W32-L150-Z04                        | ●                      | 40 | 4   | 32   | 150 | 50  | 16   |   |                                   |  |         |             |        |
| AEM90-RT16-D40-C32-L200-Z04                        | ●                      | 40 | 4   | 32   | 200 | 100 | 16   |   |                                   |  |         |             |        |
|  |                        |    |     |      |     |     |      | 4015-M4x11                                |                                   |  |         |             |        |

R: Sağ / Right / Rechts L: Sol / Left / Links

● Stokta / In Stock / Auf Lager ○ Stokta Yok / Non Stock Item / Kein Lagerartikel, Lieferzeit auf Anfrage  
SFTY Ucuna Uygundur. / Compatible with SFTY Insert. / Kompatibel mit SFTY Wendeplatten.

Sipariş Örneği/Ordering Example/Bestellbeispiel



1 ad./pcs./stück AEM90-RT07-D10-W10-L120-Z02

Kesme Hesabı : S 377 / Cutting Calculation : P 377 / Schnittberechnung : P 377



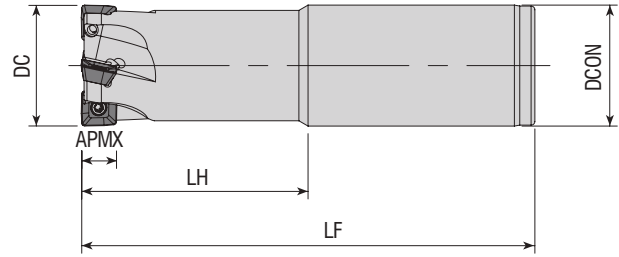



www.akkо.com.tr

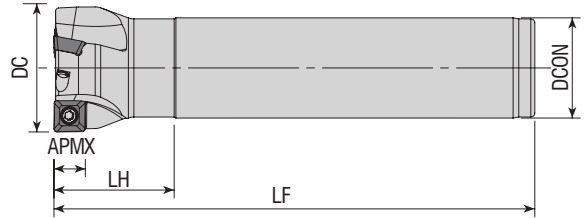

| Takım Kodu<br>Ordering Code<br>Bestell-Bezeichnung | Stok<br>Stock<br>Lager | Takım Ölçüleri (mm)<br>Dimension (mm)<br>Abmessung (mm) |      |      |     |    |      | Kesici Uç<br>Insert<br>Wendeschneidplatte   | Yedek Parçaları / Spare Parts / Ersatzteile   |   |  |
|--|------------------------|---|------|------|-----|----|------|---|---|---|--|
|  |                        | DC  | ZEFP | DCON | LF  | LH | APMX |   | Sıkma Vidası<br>Screw<br>Schraube   | Tork Anahtar<br>Torx Key<br>Torx-Schlüssel  |  |
| AEM90-SE09-D25-C25-L120-Z03-H                      | ●                      | 25  | 3    | 25   | 120 | 60 | 6.7  |  |  |  |  |
| AEM90-SE09-D25-C25-L150-Z02                        | ●                      | 25  | 2    | 25   | 150 | 50 | 6.7  |   |   |   |  |
| AEM90-SE09-D32-C32-L120-Z04-H                      | ●                      | 32  | 4    | 32   | 120 | 60 | 6.7  |   |   |   |  |
| AEM90-SE09-D32-C32-L150-Z03                        | ●                      | 32  | 3    | 32   | 150 | 50 | 6.7  |   |   |   |  |

ZCC Ucuna Uygunur. / Compatible with ZCC Insert. / Kompatibel mit ZCC Wendeplatten.



| Takım Kodu<br>Ordering Code<br>Bestell-Bezeichnung | Stok<br>Stock<br>Lager | Takım Ölçüleri (mm)<br>Dimension (mm)<br>Abmessung (mm) |      |      |     |    |      | Kesici Uç<br>Insert<br>Wendeschneidplatte   | Yedek Parçaları / Spare Parts / Ersatzteile   |   |  |
|--|------------------------|---|------|------|-----|----|------|---|---|---|--|
|  |                        | DC  | ZEFP | DCON | LF  | LH | APMX |   | Sıkma Vidası<br>Screw<br>Schraube   | Tork Anahtar<br>Torx Key<br>Torx-Schlüssel  |  |
| AEM90-S00803-D20-C16-L110-Z02-H                    | ●                      | 20  | 2    | 16   | 110 | 25 | 7    |  |  |  |  |
| AEM90-S00803-D25-C20-L110-Z02-H                    | ●                      | 25  | 2    | 20   | 110 | 25 | 7    |   |   |   |  |
| AEM90-S00803-D32-C25-L120-Z03-H                    | ●                      | 32  | 3    | 25   | 120 | 30 | 7    |   |   |   |  |

R: Sağ / Right / Rechts/ L: Sol / Left / Links

● Stokta / In Stock / Auf Lager ○ Stokta Yok / Non Stock Item / Kein Lagerartikel, Lieferzeit auf Anfrage  
SMTM Ucuna Uygunur. / Compatible with SMTM Insert. / Kompatibel mit SMTM Wendeplatten.

Sipariş Örneği/Ordering Example/ Bestellbeispiel  
1 ad./pcs./stück AEM90-SE09-D25-C25-L120-Z03-H  
Kesme Hesabı : S 377 / Cutting Calculation : P 377 / Schnittberechnung : P 377

KAPR=90°

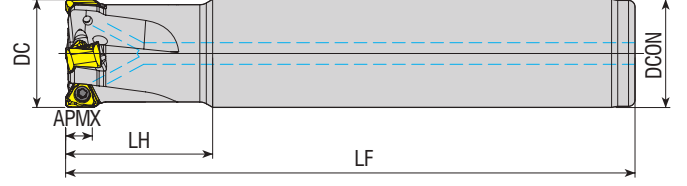







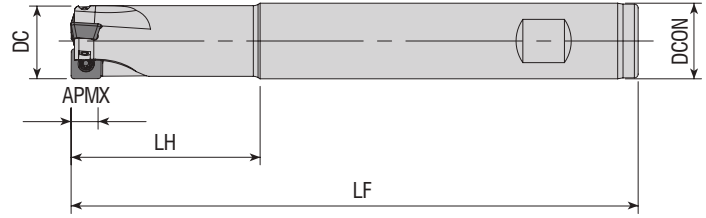





| Takım Kodu<br>Ordering Code<br>Bestell-Bezeichnung | Stok<br>Stock<br>Lager | Takım Ölçüleri (mm)<br>Dimension (mm)<br>Abmessung (mm) |      |      |     |    |      | Kesici Uç<br>Insert<br>Wendeschneidplatte | Yedek Parçaları / Spare Parts / Ersatzteile |  |             |            |        |
|--|------------------------|---|------|------|-----|----|------|---|---|--|-------------|------------|--------|
|  |                        | DC  | ZEFP | DCON | LF  | LH | APMX |   | Sıkma Vidası<br>Screw<br>Schraube           | Tork Anahtar<br>Torx Key<br>Torx-Schlüssel |             |            |        |
| <b>new</b> AEM90-TNG10-D20-W20-L90-Z02-H           | ●                      | 20  | 2    | 20   | 90  | 32 | 5    | TNGX 1004..                               | 3008-M2.5x6                                 | 82-T08                                     |             |            |        |
| <b>new</b> AEM90-TNG10-D20-W20-L90-Z03-H           | ●                      | 20  | 3    | 20   | 90  | 32 | 5    |   |   |  |             |            |        |
| AEM90-TNG10-D20-C20-L125-Z02-H                     | ●                      | 20  | 2    | 20   | 125 | 29 | 5    |   |   |  |             |            |        |
| AEM90-TNG10-D20-C20-L125-Z03-H                     | ●                      | 20  | 3    | 20   | 125 | 29 | 5    |   |   |  |             |            |        |
| AEM90-TNG10-D20-C20-L150-Z03-H                     | ●                      | 20  | 3    | 20   | 150 | 50 | 5    |   |   |  |             |            |        |
| AEM90-TNG10-D21-C20-L200-Z03-H                     | ●                      | 21  | 3    | 20   | 200 | 30 | 5    |   |   |  |             |            |        |
| AEM90-TNG10-D25-C25-L150-Z03-H                     | ●                      | 25  | 3    | 25   | 100 | 42 | 5    |   |   |  |             |            |        |
| <b>new</b> AEM90-TNG10-D25-W25-L100-Z03-H          | ●                      | 25  | 4    | 25   | 100 | 42 | 5    |   |   |  |             |            |        |
| <b>new</b> AEM90-TNG10-D25-W25-L100-Z04-H          | ●                      | 25  | 3    | 25   | 150 | 34 | 5    |   |   |  |             |            |        |
| AEM90-TNG10-D25-C25-L150-Z04-H                     | ●                      | 25  | 4    | 25   | 150 | 34 | 5    |   |   |  |             |            |        |
| AEM90-TNG10-D25-C25-L170-Z04-H                     | ●                      | 25  | 4    | 25   | 170 | 50 | 5    |   |   |  |             |            |        |
| AEM90-TNG10-D26-C25-L250-Z04-H                     | ●                      | 26  | 4    | 25   | 250 | 35 | 5    |   |   |  |             |            |        |
| <b>new</b> AEM90-TNG10-D28-W25-L100-Z04-H          | ●                      | 28  | 4    | 25   | 100 | 29 | 5    |   |   |  |             |            |        |
| <b>new</b> AEM90-TNG10-D32-W32-L110-Z04-H          | ●                      | 32  | 4    | 32   | 110 | 42 | 5    |   |   |  |             |            |        |
| <b>new</b> AEM90-TNG10-D32-W32-L110-Z05-H          | ●                      | 32  | 5    | 32   | 110 | 42 | 5    |   |   |  |             |            |        |
| AEM90-TNG10-D32-C32-L170-Z04-H                     | ●                      | 32  | 4    | 32   | 170 | 37 | 5    |   |   |  |             |            |        |
| AEM90-TNG10-D32-C32-L170-Z05-H                     | ●                      | 32  | 5    | 32   | 170 | 37 | 5    |   |   |  |             |            |        |
| AEM90-TNG10-D33-C32-L250-Z05-H                     | ●                      | 33  | 5    | 32   | 250 | 35 | 5    |   |   |  |             |            |        |
| AEM90-TNG16-D25-C25-L170-Z02-H                     | ●                      | 25  | 2    | 25   | 170 | 34 | 10   |   |   |  | TNGX 1606.. | 3015-M4x11 | 80-T15 |
| AEM90-TNG16-D25-C25-L170-Z02-H-80                  | ●                      | 25  | 2    | 25   | 170 | 80 | 10   |   |   |  |             |            |        |
| AEM90-TNG16-D25-W25-L110-Z02-H                     | ●                      | 25  | 2    | 25   | 110 | 42 | 10   |   |   |  |             |            |        |
| AEM90-TNG16-D32-C32-L195-Z02-H                     | ●                      | 32  | 2    | 32   | 195 | 34 | 10   |   |   |  |             |            |        |
| AEM90-TNG16-D32-C32-L195-Z02-H-80                  | ●                      | 32  | 2    | 32   | 195 | 80 | 10   |   |   |  |             |            |        |
| AEM90-TNG16-D32-C32-L195-Z03-H                     | ●                      | 32  | 3    | 32   | 195 | 34 | 10   |   |   |  |             |            |        |
| AEM90-TNG16-D32-W32-L110-Z03-H                     | ●                      | 32  | 3    | 32   | 110 | 42 | 10   |   |   |  |             |            |        |
| AEM90-TNG16-D35-C32-L195-Z04-H                     | ●                      | 35  | 4    | 32   | 195 | 34 | 10   |   |   |  |             |            |        |
| AEM90-TNG16-D40-W32-L120-Z04-H                     | ●                      | 40  | 4    | 32   | 120 | 50 | 10   |   |   |  |             |            |        |

R: Sağ / Right / Rechtsl L: Sol / Left / Links  
● Stokta / In Stock / Auf Lager ○ Stokta Yok / Non Stock Item / Kein Lagerartikel, Lieferzeit auf Anfrage  
PRMT Ucuna Uygunudur. / Compatible with PRMT Insert. / Kompatibel mit PRMT Wendeplatten.







Sipariş Örneği/Ordering Example/Bestellbeispiel  
1 ad./pcs./stück AEM90-TNG10-D20-W20-L90-Z02-H  
Kesme Hesabı : S 377/ Cutting Calculation : P 377 / Schnittberechnung : P 377

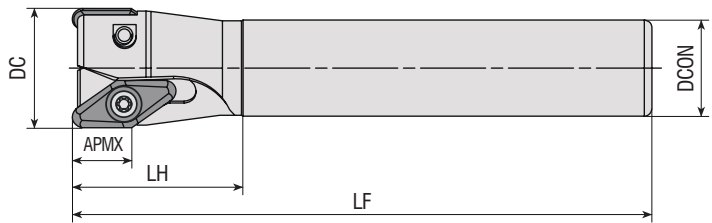

| Takım Kodu<br>Ordering Code<br>Bestell-Bezeichnung | Stok<br>Stock<br>Lager | Takım Ölçüleri (mm)<br>Dimension (mm)<br>Abmessung (mm) |      |      |     |    |      | Kesici Uç<br>Insert<br>Wendeschneidplatte   | Yedek Parçaları / Spare Parts / Ersatzteile   |   |
|--|------------------------|---|------|------|-----|----|------|---|---|---|
|  |                        | DC  | ZEPF | DCON | LF  | LH | APMX |   | Sıkma Vidası<br>Screw<br>Schraube   | Tork Anahtar<br>Torx Key<br>Torx-Schlüssel  |
| AEM90-SPGT0602-D16-W16-L150-Z02                    | ●                      | 16  | 2    | 16   | 150 | 50 | 5.5  |    |    |    |
| AEM90-SPGT07T3-D20-W20-L150-Z03                    | ●                      | 20  | 3    | 20   | 150 | 50 | 7    |    |    |    |
| AEM90-SPGT07T3-D25-W25-L150-Z03                    | ●                      | 25  | 3    | 25   | 150 | 50 | 7    |    |    |    |
| AEM90-SPGT0904-D30-W32-L150-Z03                    | ●                      | 30  | 3    | 32   | 150 | 50 | 9    |  |  |  |

ZCC Ucuna Uygunur. / Compatible with ZCC Insert. / Kompatibel mit ZCC Wendeplatten Wendeplatten.



| Takım Kodu<br>Ordering Code<br>Bestell-Bezeichnung | Stok<br>Stock<br>Lager | Takım Ölçüleri (mm)<br>Dimension (mm)<br>Abmessung (mm) |      |      |     |    |      | Kesici Uç<br>Insert<br>Wendeschneidplatte  | Yedek Parçaları / Spare Parts / Ersatzteile   |   |
|--|------------------------|---|------|------|-----|----|------|--|---|---|
|  |                        | DC  | ZEPF | DCON | LF  | LH | APMX |  | Sıkma Vidası<br>Screw<br>Schraube   | Tork Anahtar<br>Torx Key<br>Torx-Schlüssel  |
| AEM90-VC2205-D32-C25-L150-Z02-H                    | ●                      | 32  | 2    | 25   | 150 | 50 | 15   |  |  |  |
| AEM90-VC2205-D40-C32-L150-Z03-H                    | ●                      | 40  | 3    | 32   | 150 | 50 | 15   |  |  |  |

R: Sağ / Right / Rechts/ L: Sol / Left / Links

● Stokta / In Stock / Auf Lager ○ Stokta Yok / Non Stock Item / Kein Lagerartikel, Lieferzeit auf Anfrage  
ISO Ucuna Uygunur. / Compatible with ISO Insert. / Kompatibel mit ISO Wendeplatten.

Sipariş Örneği/Ordering Example/Bestellbeispiel  
1 ad./pcs./stück AEM90-SPGT0602-D16-W16-L150-Z02  
Kesme Hesabı : S 377/ Cutting Calculation : P 377 / Schnittberechnung : P 377

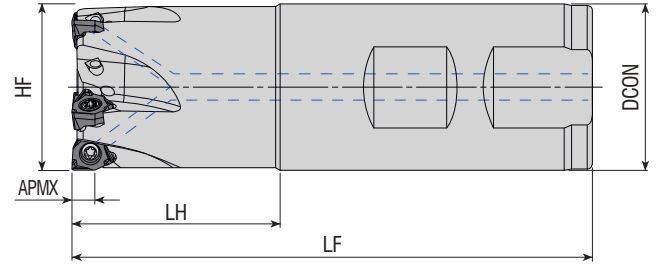

| Takım Kodu<br>Ordering Code<br>Bestell-Bezeichnung | Stok<br>Stock<br>Lager | Takım Ölçüleri (mm)<br>Dimension (mm)<br>Abmessung (mm) |      |      |     |    |      | Kesici Uç<br>Insert<br>Wendeschneidplatte | Yedek Parçaları / Spare Parts / Ersatzteile |  |  |
|--|------------------------|---|------|------|-----|----|------|---|---|--|--|
|  |                        | DC  | ZEFP | DCON | LF  | LH | APMX |   | Sıkma Vidası<br>Screw<br>Schraube           | Tork Anahtar<br>Torx Key<br>Torx-Schlüssel |  |
| new AEM90-WNG04-D20-W20-L81-Z02-H                  | ●                      | 20  | 2    | 20   | 81  | 31 | 4    | WNGU 0403..                               | 3008-M3x6                                   | 82-T08                                     |  |
| AEM90-WNG04-D20-W20-L81-Z03-H                      | ●                      | 20  | 3    | 20   | 81  | 31 | 4    |   |   |  |  |
| new AEM90-WNG04-D20-C20-L170-Z02-H                 | ●                      | 20  | 2    | 20   | 170 | 50 | 4    |   |   |  |  |
| AEM90-WNG04-D20-C20-L170-Z03-H                     | ●                      | 20  | 3    | 20   | 170 | 50 | 4    |   |   |  |  |
| AEM90-WNG04-D25-W25-L88-Z03-H                      | ●                      | 25  | 3    | 25   | 88  | 32 | 4    |   |   |  |  |
| AEM90-WNG04-D25-W25-L88-Z04-H                      | ●                      | 25  | 4    | 25   | 88  | 32 | 4    |   |   |  |  |
| new AEM90-WNG04-D25-C25-L170-Z02-H                 | ●                      | 25  | 2    | 25   | 170 | 50 | 4    |   |   |  |  |
| AEM90-WNG04-D25-C25-L170-Z03-H                     | ●                      | 25  | 3    | 25   | 170 | 50 | 4    |   |   |  |  |
| AEM90-WNG04-D32-W25-L100-Z05-H                     | ●                      | 32  | 5    | 25   | 100 | 35 | 4    |   |   |  |  |
| AEM90-WNG04-D32-W32-L100-Z05-H                     | ●                      | 32  | 5    | 32   | 100 | 40 | 4    |   |   |  |  |
| new AEM90-WNG04-D32-C32-L170-Z03-H                 | ●                      | 32  | 3    | 32   | 170 | 50 | 4    |   |   |  |  |
| AEM90-WNG04-D32-C25-L170-Z04-H                     | ●                      | 32  | 4    | 25   | 170 | 35 | 4    |   |   |  |  |
| AEM90-WNG04-D32-C32-L170-Z04-H                     | ●                      | 32  | 4    | 32   | 170 | 50 | 4    |   |   |  |  |
| new AEM90-WNG08-D32-C32-L170-Z02-H                 | ●                      | 32  | 2    | 32   | 170 | 50 | 7.5  | WNGU 0806..                               | 4015-M4x11                                  | 80-T15                                     |  |
| AEM90-WNG08-D40-W32-L100-Z03-H                     | ●                      | 40  | 3    | 32   | 100 | 35 | 7.5  |   |   |  |  |
| new AEM90-WNG08-D40-W40-L110-Z03-H                 | ●                      | 40  | 3    | 40   | 110 | 40 | 7.5  |   |   |  |  |
| AEM90-WNG08-D40-C32-L170-Z03-H                     | ●                      | 40  | 3    | 32   | 170 | 35 | 7.5  |   |   |  |  |

XTC-GSC Ucuna Uygunudur. / Compatible with XTC-GSC Insert. / Kompatibel mit XTC-GSC Wendeplatten.

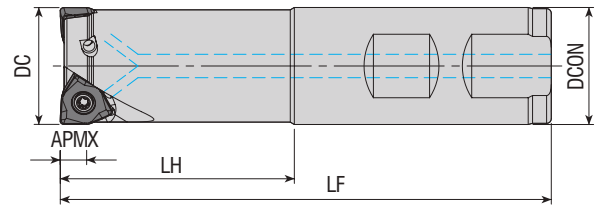

| Takım Kodu<br>Ordering Code<br>Bestell-Bezeichnung | Stok<br>Stock<br>Lager | Takım Ölçüleri (mm)<br>Dimension (mm)<br>Abmessung (mm) |      |      |     |     |      | Kesici Uç<br>Insert<br>Wendeschneidplatte | Yedek Parçaları / Spare Parts / Ersatzteile |  |  |
|--|------------------------|---|------|------|-----|-----|------|---|---|--|--|
|  |                        | DC  | ZEFP | DCON | LF  | LH  | APMX |   | Sıkma Vidası<br>Screw<br>Schraube           | Tork Anahtar<br>Torx Key<br>Torx-Schlüssel |  |
| AEM90L-WN0604Z-D25-C25-L200-Z02-H                  | ●                      | 25  | 2    | 25   | 200 | 100 | 5.7  | WNHU 0604..                               | 3008-M3x8                                   | 82-T08                                     |  |
| AEM90-WN0604Z-D25-W25-L150-Z02-H                   | ●                      | 25  | 2    | 25   | 150 | 50  | 5.7  |   |   |  |  |
| AEM90-WN0604Z-D32-W32-L150-Z03-H                   | ●                      | 32  | 3    | 32   | 150 | 50  | 5.7  |   |   |  |  |
| AEM90-WN0604Z-D40-W32-L150-Z04-H                   | ●                      | 40  | 4    | 32   | 150 | 35  | 5.7  |   |   |  |  |

R: Sağ / Right / Rechts | L: Sol / Left / Links  
● Stokta / In Stock / Auf Lager ○ Stokta Yok / Non Stock Item / Kein Lagerartikel, Lieferzeit auf Anfrage  
ZCC Ucuna Uygunudur. / Compatible with ZCC Insert. / Kompatibel mit ZCC Wendeplatten.

Sipariş Örneği/Ordering Example/Bestellbeispiel

1 ad./pcs./stück AEM90-WNG04-D20-W20-L81-Z02-H

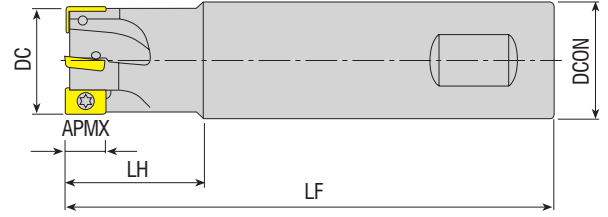

Kesme Hesabı : S 377 / Cutting Calculation : P 377 / Schnittberechnung : P 377

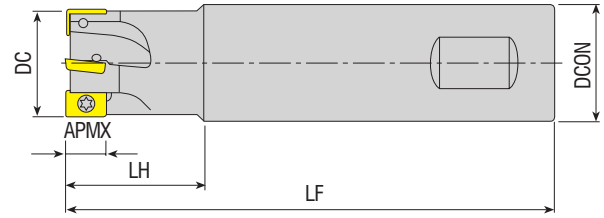

| Takım Kodu<br>Ordering Code<br>Bestell-Bezeichnung | Stok<br>Stock<br>Lager | Takım Ölçüleri (mm)<br>Dimension (mm)<br>Abmessung (mm) |      |      |     |    |      | Kesici Uç<br>Insert<br>Wendeschneidplatte  | Yedek Parçaları / Spare Parts / Ersatzteile   |   |        |
|--|------------------------|---|------|------|-----|----|------|--|---|---|--------|
|  |                        | DC  | ZEFP | DCON | LF  | LH | APMX |  | Sıkma Vidası<br>Screw<br>Schraube   | Tork Anahtar<br>Torx Key<br>Torx-Schlüssel  |        |
| AEM90-XD11T3-D16-W16-L150-Z02                      | ●                      | 16  | 2    | 16   | 150 | 30 | 10   |  |  |  |        |
| AEM90-XD11T3-D17-C16-L150-Z02                      | ●                      | 17  | 2    | 16   | 150 | 30 | 10   |  |   |   |        |
| AEM90-XD11T3-D20-W20-L150-Z03                      | ●                      | 20  | 3    | 20   | 150 | 50 | 10   |  |   |   |        |
| AEM90-XD11T3-D21-C20-L080-Z03-H                    | ●                      | 21  | 3    | 20   | 80  | 25 | 10   |  | XD.T 11T3..   | 3008-M2.5x6   | 82-T08 |
| AEM90-XD11T3-D21-C20-L150-Z03                      | ●                      | 21  | 3    | 20   | 150 | 30 | 10   |  |   |   |        |
| AEM90-XD11T3-D25-W25-L150-Z04                      | ●                      | 25  | 4    | 25   | 150 | 50 | 10   |  |   |   |        |
| AEM90-XD11T3-D30-W25-L120-Z04                      | ●                      | 30  | 4    | 25   | 120 | 30 | 10   |  |   |   |        |
| AEM90-XD11T3-D32-W32-L150-Z04                      | ●                      | 32  | 4    | 32   | 150 | 50 | 10   |  |   |   |        |
| AEM90-XD11T3-D33-C20-L080-Z04-H                    | ●                      | 33  | 4    | 20   | 80  | 30 | 10   |  |   |   |        |

CRTZT Ucuna Uygunur. / Compatible with CRTZT Insert. / Kompatibel mit CRTZT Wendeplatten.

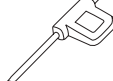

| Takım Kodu<br>Ordering Code<br>Bestell-Bezeichnung | Stok<br>Stock<br>Lager | Takım Ölçüleri (mm)<br>Dimension (mm)<br>Abmessung (mm) |      |      |     |    |      | Kesici Uç<br>Insert<br>Wendeschneidplatte  | Yedek Parçaları / Spare Parts / Ersatzteile   |   |
|--|------------------------|---|------|------|-----|----|------|--|---|---|
|  |                        | DC  | ZEFP | DCON | LF  | LH | APMX |  | Sıkma Vidası<br>Screw<br>Schraube   | Tork Anahtar<br>Torx Key<br>Torx-Schlüssel  |
| AEM90-XC13-D20-W20-L150-Z02                        | ●                      | 20  | 2    | 20   | 150 | 60 | 13   |  |  |  |
| AEM90-XC13-D25-W25-L150-Z03                        | ●                      | 25  | 3    | 25   | 150 | 60 | 13   |  |   |   |
| AEM90-XC13-D32-W32-L150-Z04                        | ●                      | 32  | 4    | 32   | 150 | 60 | 13   |  | XCKX 13T3..   | 3008-M3x8   |

R: Sağ / Right / Rechts/ L: Sol / Left / Links

● Stokta / In Stock / Auf Lager ○ Stokta Yok / Non Stock Item / Kein Lagerartikel, Lieferzeit auf Anfrage  
SC Ucuna Uygunur. / Compatible with SC Insert. / Kompatibel mit SC Wendeplatten.

Sipariş Örneği/Ordering Example/Bestellbeispiel

1 ad./pcs./stück AEM90-XD11T3-D16-W16-L150-Z02

Kesme Hesabı : S 377 / Cutting Calculation : P 377 / Schnittberechnung : P 377

## S-SİSTEM YÜZEY PARMAK FREZELER

S-SYSTEM END MILLS

S-SYSTEM SCHAFTFRÄSER

KAPR=90°

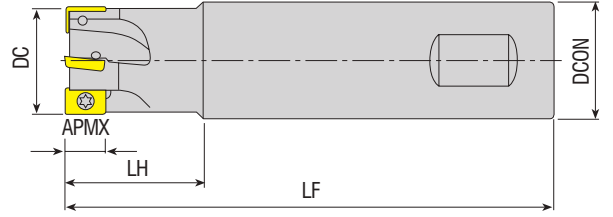

| Takım Kodu<br>Ordering Code<br>Bestell-Bezeichnung | Stok<br>Stock<br>Lager | Takım Ölçüleri (mm)<br>Dimension (mm)<br>Abmessung (mm) |      |      |     |     |      | Kesici Uç<br>Insert<br>Wendeschneidplatte | Yedek Parçaları / Spare Parts / Ersatzteile |  |
|--|------------------------|---|------|------|-----|-----|------|---|---|--|
|  |                        | DC  | ZEFP | DCON | LF  | LH  | APMX |   | Sıkma Vidası<br>Screw<br>Schraube           | Tork Anahtar<br>Torx Key<br>Torx-Schlüssel |
| AEM90-X006-D10-C12-L120-Z02                        | ●                      | 10  | 2    | 12   | 120 | 50  | 5    |   |   |  |
| AEM90-X006-D12-C12-L120-Z02                        | ●                      | 12  | 2    | 12   | 120 | 25  | 5    |   |   |  |
| AEM90-X009-D16-W16-L150-Z02                        | ●                      | 16  | 2    | 16   | 150 | 50  | 8    |   |   |  |
| AEM90-X009-D20-W20-L150-Z03                        | ●                      | 20  | 3    | 20   | 150 | 50  | 8    |   |   |  |
| AEM90-X012-D20-W20-L150-Z02                        | ●                      | 20  | 2    | 20   | 150 | 50  | 11   |   |   |  |
| AEM90-X012-D20-C20-L200-Z02                        | ●                      | 20  | 2    | 20   | 200 | 100 | 11   |   |   |  |
| AEM90-X012-D22-W20-L150-Z02                        | ●                      | 22  | 2    | 20   | 150 | 30  | 11   |   |   |  |
| AEM90-X012-D25-W25-L150-Z03                        | ●                      | 25  | 3    | 25   | 150 | 50  | 11   |   |   |  |
| AEM90-X012-D25-C25-L200-Z03                        | ●                      | 25  | 3    | 25   | 200 | 100 | 11   |   |   |  |
| AEM90-X012-D32-C25-L150-Z04                        | ●                      | 32  | 4    | 25   | 150 | 40  | 11   |   |   |  |
| AEM90-X012-D32-W32-L150-Z04                        | ●                      | 32  | 4    | 32   | 150 | 50  | 11   |   |   |  |
| AEM90-X012-D32-C32-L250-Z04                        | ●                      | 32  | 4    | 32   | 250 | 100 | 11   |   |   |  |

SC Ucuna Uygundur. / Compatible with SC Insert. / Kompatibel mit SC Wendeplatten.

KAPR=90°

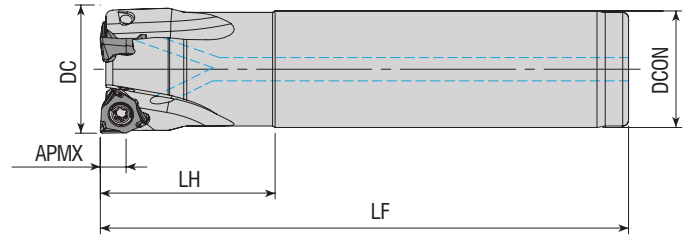

| Takım Kodu<br>Ordering Code<br>Bestell-Bezeichnung | Stok<br>Stock<br>Lager | Takım Ölçüleri (mm)<br>Dimension (mm)<br>Abmessung (mm) |      |      |     |    |      | Kesici Uç<br>Insert<br>Wendeschneidplatte | Yedek Parçaları / Spare Parts / Ersatzteile |  |
|--|------------------------|---|------|------|-----|----|------|---|---|--|
|  |                        | DC  | ZEFP | DCON | LF  | LH | APMX |   | Sıkma Vidası<br>Screw<br>Schraube           | Tork Anahtar<br>Torx Key<br>Torx-Schlüssel |
| AEM90-XN0403-D16-C16-L100-Z01-H                    | ●                      | 16  | 1    | 16   | 100 | 30 | 4    |   |   |  |
| AEM90-XN0403-D22-C20-L110-Z03-H                    | ●                      | 22  | 3    | 20   | 110 | 30 | 4    |   |   |  |
| AEM90-XN0806-D32-C32-L110-Z02-H                    | ●                      | 32  | 2    | 32   | 110 | 40 | 7.5  |   |   |  |

R: Sağ / Right / Rechts/ L: Sol / Left / Links

● Stokta / In Stock / Auf Lager ○ Stokta Yok / Non Stock Item / Kein Lagerartikel, Lieferzeit auf Anfrage

SC Ucuna Uygundur. / Compatible with SC Insert. / Kompatibel mit SC Wendeplatten.



Sipariş Örneği/Ordering Example/Bestellbeispiel

1 ad./pcs./stück AEM90-X006-D10-C12-L120-Z02

Kesme Hesabı : S 377 / Cutting Calculation : P 377 / Schnittberechnung : P 377

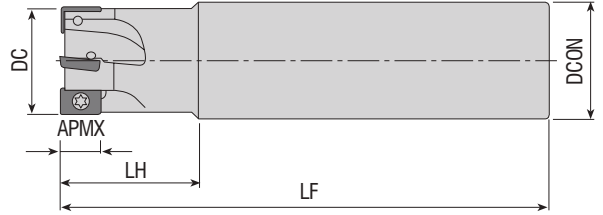



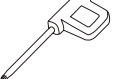

| Takım Kodu<br>Ordering Code<br>Bestell-Bezeichnung | Stok<br>Stock<br>Lager | Takım Ölçüleri (mm)<br>Dimension (mm)<br>Abmessung (mm) |      |      |     |    |      | Kesici Uç<br>Insert<br>Wendeschneidplatte   | Yedek Parçaları / Spare Parts / Ersatzteile   |   |
|--|------------------------|---|------|------|-----|----|------|---|---|---|
|  |                        | DC  | ZEFP | DCON | LF  | LH | APMX |   | Sıkma Vidası<br>Screw<br>Schraube   | Tork Anahtar<br>Torx Key<br>Torx-Schlüssel  |
| AEM90-ZC1003-D16-C14-L150-Z02                      | ●                      | 16  | 2    | 14   | 150 | 25 | 9    |  |  |  |
| AEM90-ZC1003-D16-C14-L200-Z02                      | ●                      | 16  | 2    | 14   | 200 | 25 | 9    |   |   |   |
| AEM90-ZC1003-D16-C15-L150-Z02                      | ●                      | 16  | 2    | 15   | 150 | 25 | 9    |   |   |   |
| AEM90-ZC1003-D16-C16-L150-Z02                      | ●                      | 16  | 2    | 16   | 150 | 25 | 9    |   |   |   |
| AEM90-ZC1003-D16-C16-L200-Z02                      | ●                      | 16  | 2    | 16   | 200 | 50 | 9    |   |   |   |
| AEM90-ZC1003-D17-C16-L150-Z02                      | ●                      | 17  | 2    | 16   | 150 | 25 | 9    |   |   |   |
| AEM90-ZC1003-D17-C16-L200-Z02                      | ●                      | 17  | 2    | 16   | 200 | 25 | 9    |   |   |   |
| AEM90-ZC1003-D20-C18-L150-Z03                      | ●                      | 20  | 3    | 18   | 150 | 25 | 9    |   |   |   |
| AEM90-ZC1003-D20-C18-L200-Z02                      | ●                      | 20  | 2    | 18   | 200 | 25 | 9    |   |   |   |
| AEM90-ZC1003-D20-C20-L150-Z03                      | ●                      | 20  | 3    | 20   | 150 | 40 | 9    |   |   |   |
| AEM90-ZC1003-D20-C18-L200-Z03                      | ●                      | 20  | 3    | 18   | 200 | 25 | 9    |   |   |   |
| AEM90-ZC1003-D21-C20-L150-Z02                      | ●                      | 21  | 2    | 20   | 150 | 30 | 9    |   |   |   |
| AEM90-ZC1003-D21-C20-L150-Z03                      | ●                      | 21  | 3    | 20   | 150 | 30 | 9    |   |   |   |
| AEM90-ZC1003-D21-C20-L200-Z03                      | ●                      | 21  | 3    | 20   | 200 | 30 | 9    |   |   |   |
| AEM90-ZC1003-D25-C20-L150-Z03                      | ●                      | 25  | 3    | 20   | 150 | 30 | 9    |   |   |   |
| AEM90-ZC1003-D25-C20-L200-Z03                      | ●                      | 25  | 3    | 20   | 200 | 30 | 9    |   |   |   |
| AEM90-ZC1003-D25-C25-L150-Z03                      | ●                      | 25  | 3    | 25   | 150 | 40 | 9    |   |   |   |
| AEM90-ZC1003-D26-C25-L170-Z03                      | ●                      | 26  | 3    | 25   | 170 | 25 | 9    |   |   |   |
| AEM90-ZC1003-D26-C25-L200-Z03                      | ●                      | 26  | 3    | 25   | 200 | 25 | 9    |   |   |   |
| AEM90-ZC1003-D32-C25-L180-Z04                      | ●                      | 32  | 4    | 25   | 180 | 30 | 9    |   |   |   |
| AEM90-ZC1003-D33-C32-L200-Z04                      | ●                      | 33  | 4    | 32   | 200 | 25 | 9    |   |   |   |

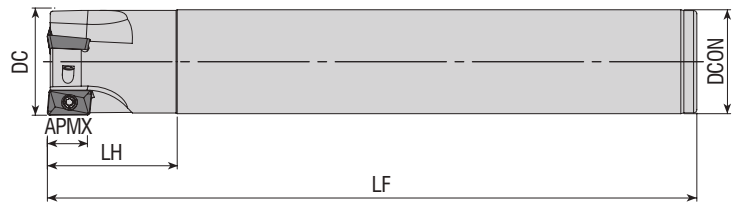
DJT Ucuna Uygundur. / Compatible with DJT Insert. / Kompatibel mit DJT Wendeplatten.

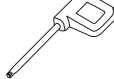

| Takım Kodu<br>Ordering Code<br>Bestell-Bezeichnung | Stok<br>Stock<br>Lager | Takım Ölçüleri (mm)<br>Dimension (mm)<br>Abmessung (mm) |      |      |     |    |      | Kesici Uç<br>Insert<br>Wendeschneidplatte   | Yedek Parçaları / Spare Parts / Ersatzteile   |   |
|--|------------------------|---|------|------|-----|----|------|---|---|---|
|  |                        | DC  | ZEFP | DCON | LF  | LH | APMX |   | Sıkma Vidası<br>Screw<br>Schraube   | Tork Anahtar<br>Torx Key<br>Torx-Schlüssel  |
| AEM90-ZP13T3-D26-C25-L200-Z02                      | ●                      | 26  | 2    | 25   | 200 | 35 | 13   |  |  |  |
| AEM90-ZP13T3-D26-C25-L200-Z03                      | ●                      | 26  | 3    | 25   | 200 | 35 | 13   |   |   |   |
| AEM90-ZP13T3-D26-C25-L250-Z02                      | ●                      | 26  | 2    | 25   | 250 | 35 | 13   |   |   |   |
| AEM90-ZP13T3-D33-C32-L200-Z03                      | ●                      | 33  | 3    | 32   | 200 | 40 | 13   |   |   |   |
| AEM90-ZP13T3-D33-C32-L250-Z03                      | ●                      | 33  | 3    | 32   | 250 | 40 | 13   |   |   |   |

R: Sağ / Right / Rechts | L: Sol / Left / Links

● Stokta / In Stock / Auf Lager ○ Stokta Yok / Non Stock Item / Kein Lagerartikel, Lieferzeit auf Anfrage

DJT Ucuna Uygundur. / Compatible with DJT Insert. / Kompatibel mit DJT Wendeplatten.

Sipariş Örneği/Ordering Example/Bestellbeispiel

1 ad./pcs./stück AEM90-ZC1003-D16-C14-L150-Z02

Kesme Hesabı : S 377 / Cutting Calculation : P 377 / Schnittberechnung : P 377

KAPR=90°

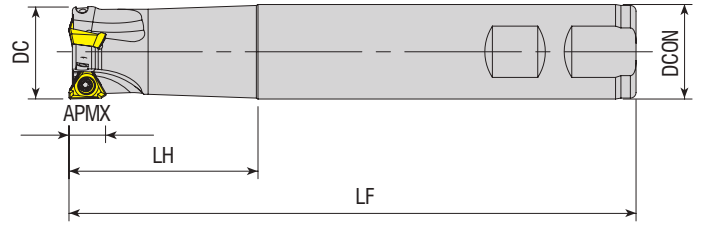

**Takım Kodu**  
**Ordering Code**  
**Bestell-Bezeichnung**

Stok  
Stock  
LagerTakım Ölçüleri (mm)  
Dimension (mm)  
Abmessung (mm)Kesici Uç  
Insert  
Wendeschneidplatte

Yedek Parçaları / Spare Parts / Ersatzteile

Sıkma Vidası  
Screw  
SchraubeTork Anahtar  
Torx Key  
Torx-Schlüssel

new

AEM90-3P0603-D12-C12-L120-Z01-H

●

12

1

12

120

25

4.7

3PKT 0603

3006-M2x4

82-T06

AEM90-3P0603-D16-W16-L120-Z03-H

●

16

3

16

120

25

4.7

AEM90-3P0603-D20-W20-L150-Z03-H

●

20

3

20

150

25

4.7

AEM90-3P0603-D25-W25-L150-Z05-H

●

25

5

25

150

25

4.7

AEM90-3P1004-D20-W20-L150-Z02

●

20

2

20

150

40

7

3PKT 1004

1108-M2.5x6

82-T08

AEM90-3P1004-D21-C20-L200-Z02

●

21

2

20

200

30

7

new

AEM90-3P1004-D22-W20-L150-Z02

●

22

2

20

150

30

7

AEM90-3P1004-D25-W25-L150-Z03

●

25

3

25

150

40

7

AEM90-3P1505-D32-W32-L150-Z03

●

32

3

32

150

50

11

AEM90-3P1505-D38-W32-L150-Z03

●

38

3

32

150

35

11

3PKT 1505

1115-M4x10

80-T15

AEM90-3P1505-D40-W32-L150-Z04

●

40

4

32

150

35

11

TGTC Ucuna Uygun. / Compatible with TGTC Insert. / Kompatibel mit TGTC Wendeplatten.

KAPR=90°

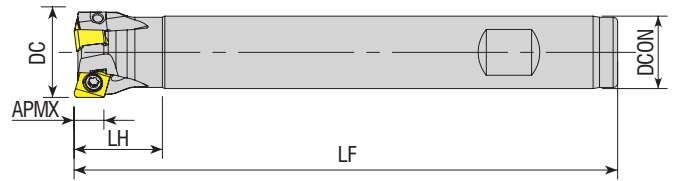

**Takım Kodu**  
**Ordering Code**  
**Bestell-Bezeichnung**

Stok  
Stock  
LagerTakım Ölçüleri (mm)  
Dimension (mm)  
Abmessung (mm)Kesici Uç  
Insert  
Wendeschneidplatte

Yedek Parçaları / Spare Parts / Ersatzteile

Sıkma Vidası  
Screw  
SchraubeTork Anahtar  
Torx Key  
Torx-Schlüssel

AEM90-4N06-D16-W16-L120-Z02-H

●

16

2

16

120

25

6

4NKT 0603..

1108-M3x6.8

82-T08

AEM90-4N06-D16-W16-L160-Z02

●

16

2

16

160

25

6

AEM90-4N06-D20-W16-L120-Z03-H

●

20

3

16

120

20

6

AEM90-4N06-D20-W16-L160-Z03

●

20

3

16

160

20

6

new

AEM90-4N06-D20-W20-L160-Z03

●

20

3

20

160

25

6

TGTC Ucuna Uygun. / Compatible with TGTC Insert. / Kompatibel mit TGTC Wendeplatten.

R: Sağ / Right / Rechts | L: Sol / Left / Links

● Stokta / In Stock / Auf Lager ○ Stokta Yok / Non Stock Item / Kein Lagerartikel, Lieferzeit auf Anfrage

Sipariş Örneği/Ordering Example/Bestellbeispiel

1 ad./pcs./stück AEM90-3P0603-D12-C12-L120-Z01-H

Kesme Hesabı : S 377/ Cutting Calculation : P 377 / Schnittberechnung : P 377

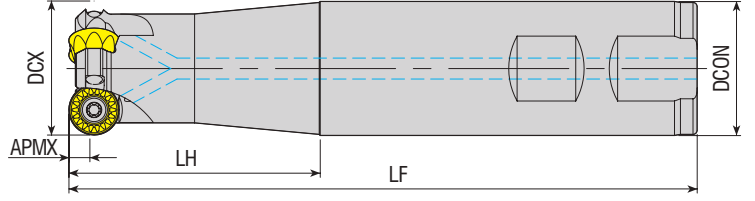

| Takım Kodu<br>Ordering Code<br>Bestell-Bezeichnung | Stok<br>Stock<br>Lager | Takım Ölçüleri (mm)<br>Dimension (mm)<br>Abmessung (mm) |      |      |     |     |      | Kesici Uç<br>Insert<br>Wendeschneidplatte | Yedek Parçaları / Spare Parts / Ersatzteile |   |   |  |
|--|------------------------|---|------|------|-----|-----|------|---|---|---|---|--|
|  |                        | DCX   | ZEFP | DCON | LF  | LH  | APMX |   | Sıkma Vidası<br>Screw<br>Schraube           | Baskı Parçası<br>Wedge Clamp<br>Spannpratze | Baskı Vidası<br>Clamp Screw<br>Schraube | Tork Anahtar<br>Torx Key<br>Torx-Schlüssel |
| AEMR-RP08T2M-D20-W20-L150-Z02-H                    | ●                      | 20  | 2    | 20   | 150 | 60  | 4    | RPMT 08T2..                               | 3008-M2.5x6                                 | -   | -                                       | 82-T08                                     |
| AEMR-RP08T2M-D25-W25-L200-Z03-H                    | ●                      | 25  | 3    | 25   | 200 | 100 | 4    |   |   |   |   |  |
| AEMR-RP10T3M-D25-W25-L200-Z02-H                    | ●                      | 25  | 2    | 25   | 200 | 100 | 5    | RPMT 10T3..                               | 4015-M3.5x9                                 | -   | -                                       |  |
| AEMR-RP10T3M-D32-W32-L200-Z03-H                    | ●                      | 32  | 3    | 32   | 200 | 100 | 5    |   |   |   |   |  |
| new AEMR-RP1204M-D25-C25-L180-Z02                  | ●                      | 25  | 2    | 25   | 180 | 50  | 6    | RPMT 1204..                               | 4015-M4x9                                   | -   | -                                       | 80-T15                                     |
| new AEMR-RP1204M-D25-C25-L180-Z02-H                | ●                      | 25  | 2    | 25   | 180 | 50  | 6    |   |   |   |   |  |
| AEMR-RP1204M-D32-W32-L150-Z03-H                    | ●                      | 32  | 3    | 32   | 150 | 60  | 6    |   |   |   |   |  |
| AEMR-RP1204M-D32-W32-L200-Z03-H                    | ●                      | 32  | 3    | 32   | 200 | 100 | 6    |   |   |   |   |  |
| new AEMR-RP1204M-D36-C25-L160-Z03                  | ●                      | 36  | 3    | 25   | 160 | 30  | 3    |   |   |   |   |  |
| AEMR-RP1606M-D40-W32-L150-Z02-H                    | ●                      | 40  | 2    | 16   | 150 | 35  | 8    | RPMT 1606..                               | 1020-M5x11                                  | -   | -                                       | 80-T20                                     |
| AEMR-RP1606M-D40-W32-L200-Z02-H                    | ●                      | 40  | 2    | 16   | 200 | 35  | 8    |   |   |   |   |  |

R: Sağ / Right / Rechts L: Sol / Left / Links

● Stokta / In Stock / Auf Lager ○ Stokta Yok / Non Stock Item / Kein Lagerartikel, Lieferzeit auf Anfrage  
MTSBH Ucuna Uygunudur. / Compatible with MTSBH Insert. / Kompatibel mit MTSBH Wendeplatten.

Sipariş Örneği/Ordering Example/Bestellbeispiel

1 ad./pcs./stück AEMR-RP08T2M-D20-W20-L150-Z02-H

Kesme Hesabı : S 377 / Cutting Calculation : P 377 / Schnittberechnung : P 377



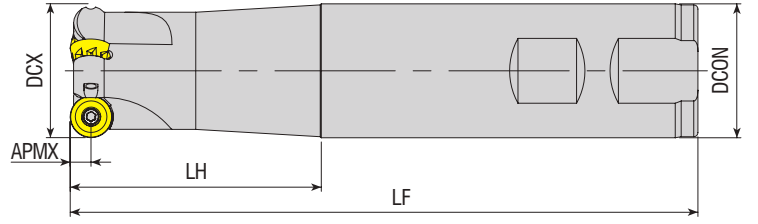

| Takım Kodu<br>Ordering Code<br>Bestell-Bezeichnung | Stok<br>Stock<br>Lager | Takım Ölçüleri (mm)<br>Dimension (mm)<br>Abmessung (mm) |      |      |     |    |      | Kesici Uç<br>Insert<br>Wendeschneidplatte | Yedek Parçaları / Spare Parts / Ersatzteile |   |   |  |
|--|------------------------|---|------|------|-----|----|------|---|---|---|---|--|
|  |                        | DCX   | ZEFP | DCON | LF  | LH | APMX |   | Sıkma Vidası<br>Screw<br>Schraube           | Baskı Parçası<br>Wedge Clamp<br>Spannpratze | Baskı Vidası<br>Clamp Screw<br>Schraube | Tork Anahtar<br>Torx Key<br>Torx-Schlüssel |
| AEMR-RP10T3-D25-W25-L125-Z02                       | ●                      | 25  | 2    | 25   | 125 | 60 | 5    | RPNX 10T3..                               | 4010-M3x8                                   | -   | -                                       | 82-T10                                     |
| AEMR-RP10T3-D25-W25-L150-Z02                       | ●                      | 25  | 2    | 25   | 150 | 60 | 5    |   |   |   |   |  |
| AEMR-RP10T3-D32-W32-L150-Z03                       | ●                      | 32  | 3    | 32   | 150 | 60 | 5    |   |   |   |   |  |

CRTZT Ucuna Uygunur. / Compatible with CRTZT Insert. / Kompatibel mit CRTZT Wendeplatten.

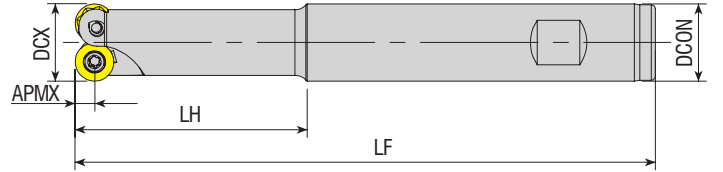

| Takım Kodu<br>Ordering Code<br>Bestell-Bezeichnung | Stok<br>Stock<br>Lager | Takım Ölçüleri (mm)<br>Dimension (mm)<br>Abmessung (mm) |      |      |     |     |      | Kesici Uç<br>Insert<br>Wendeschneidplatte | Yedek Parçaları / Spare Parts / Ersatzteile |  |  |
|--|------------------------|---|------|------|-----|-----|------|---|---|--|--|
|  |                        | DCX   | ZEFP | DCON | LF  | LH  | APMX |   | Sıkma Vidası<br>Screw<br>Schraube           | Tork Anahtar<br>Torx Key<br>Torx-Schlüssel |  |
| AEMR-RY08-D16-W16-L150-Z02                         | ●                      | 16  | 2    | 16   | 150 | 55  | 4    | RYMX 0803..                               | 4010-M3x6                                   | 82-T10                                     |  |
| AEMR-RY10-D20-W20-L150-Z02                         | ●                      | 20  | 2    | 20   | 150 | 60  | 5    | RYMX 1004..                               | 4015-M3.5x8                                 | 80-T15                                     |  |
| AEMR-RY10-D20-C20-L200-Z02                         | ●                      | 20  | 2    | 20   | 200 | 100 | 5    |   |   |  |  |
| AEMR-RY10-D21-W20-L200-Z02-H                       | ●                      | 21  | 2    | 20   | 200 | 30  | 5    |   |   |  |  |
| AEMR-RY10-D25-W25-L150-Z02                         | ●                      | 25  | 2    | 25   | 150 | 60  | 5    | RYMX 1205..                               | 4015-M4x11                                  |  |  |
| AEMR-RY10-D26-W25-L200-Z02-H                       | ●                      | 26  | 2    | 25   | 200 | 60  | 5    |   |   |  |  |
| AEMR-RY10-D32-W32-L160-Z04-H                       | ●                      | 32  | 4    | 32   | 160 | 60  | 5    |   |   |  |  |
| AEMR-RY12-D32-C25-L160-Z03                         | ●                      | 32  | 3    | 25   | 160 | 30  | 6    |   |   |  |  |

R: Sağ / Right / Rechts/ L: Sol / Left / Links

● Stokta / In Stock / Auf Lager ○ Stokta Yok / Non Stock Item / Kein Lagerartikel, Lieferzeit auf Anfrage  
TGTC Ucuna Uygunur. / Compatible with TGTC Insert. / Kompatibel mit TGTC Wendeplatten.

Sipariş Örneği/Ordering Example/Bestellbeispiel

1 ad./pcs./stück AEMR-RP10T3-D25-W25-L125-Z02

Kesme Hesabı : S 377/ Cutting Calculation : P 377 / Schnittberechnung : P 377

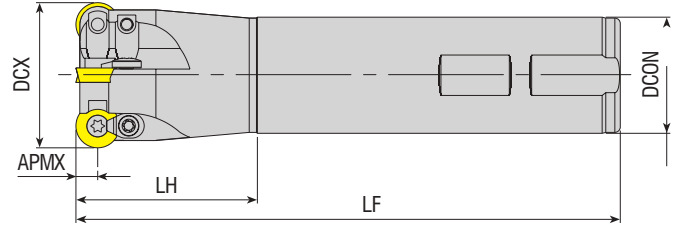

**Takım Kodu**  
**Ordering Code**  
**Bestell-Bezeichnung**

Stok  
Stock  
Lager

Takım Ölçüleri (mm)  
Dimension (mm)  
Abmessung (mm)

Kesici Uç  
Insert  
Wendeschneidplatte

Yedek Parçaları / Spare Parts / Ersatzteile

Sıkma Vidası  
Screw  
Schraube

Baskı Parçası  
Wedge Clamp  
Spannpratze

Baskı Vidası  
Clamp Screw  
Schraube

Tork Anahtar  
Torx Key  
Torx-Schlüssel

|                                     | DCX | ZEP | DCON | LF | LH  | APMX |     |           |              |             |             |        |              |        |
|-------------------------------------|-----|-----|------|----|-----|------|-----|-----------|--------------|-------------|-------------|--------|--------------|--------|
| AEMR-RD0501-D08-W10-L100-Z01-H      | ●   | 8   | 1    | 10 | 100 | 20   | 2.5 | RD.. 0501 | 3006-M2x3.6  |             |             | 82-T06 |              |        |
| AEMR-RD0501-D10-W12-L100-Z02-H      | ●   | 10  | 2    | 12 | 100 | 20   | 2.5 |           | 3006-M2x4    |             |             |        |              |        |
| AEMR-RD0501-D12-W12-L120-Z02-H      | ●   | 12  | 2    | 12 | 120 | 20   | 2.5 | RD.. 0803 | 3008-M3x6    | -           | -           | 82-T08 |              |        |
| AEMR-RD0803-D16-W16-L150-Z02        | ●   | 16  | 2    | 16 | 150 | 60   | 4   |           |              |             |             |        |              |        |
| AEMR-RD0803-D16-C20-L200-Z02        | ●   | 16  | 2    | 20 | 200 | 60   | 4   | RD.. 08T2 | 3008-M2.5x6  |             |             | 82-T08 |              |        |
| AEMR-RD0803-D20-W20-L150-Z03        | ●   | 20  | 3    | 20 | 150 | 60   | 4   |           |              |             |             |        |              |        |
| AEMR-RD08T2-D16-W16-L150-Z02        | ●   | 16  | 2    | 16 | 150 | 60   | 4   | RD.. 1003 |              |             |             | 82-T08 |              |        |
| AEMR-RD08T2-D20-W20-L150-Z02        | ●   | 20  | 2    | 20 | 150 | 60   | 4   |           |              |             |             |        |              |        |
| AEMRC-RD1003-D20-W20-L150-Z02       | ●   | 20  | 2    | 20 | 150 | 60   | 5   | RD.. 1003 |              |             |             | 82-T08 |              |        |
| AEMRC-RD1003-D20-C20-L160-Z02       | ●   | 20  | 2    | 20 | 160 | 70   | 5   |           |              |             |             |        |              |        |
| AEMRC-RD1003-D20-C20-L250-Z02       | ●   | 20  | 2    | 20 | 250 | 150  | 5   |           |              |             |             |        |              |        |
| AEMRC-RD1003-D21-C20-L160-Z02       | ●   | 21  | 2    | 20 | 160 | 70   | 5   |           |              |             |             |        |              |        |
| AEMRC-RD1003-D25-W25-L150-Z02       | ●   | 25  | 2    | 25 | 150 | 60   | 5   |           |              |             |             |        |              |        |
| AEMRC-RD1003-D25-C25-L160-Z02       | ●   | 25  | 2    | 25 | 160 | 70   | 5   |           |              |             |             |        |              |        |
| AEMRC-RD1003-D25-C25-L200-Z02       | ●   | 25  | 2    | 25 | 200 | 100  | 5   |           |              |             |             |        |              |        |
| AEMRC-RD1003-D25-C25-L200-Z02       | ●   | 25  | 2    | 25 | 200 | 100  | 5   |           |              |             |             |        |              |        |
| AEMRC-RD1003-D25-C25-L250-Z02       | ●   | 25  | 2    | 25 | 250 | 150  | 5   |           |              |             |             |        |              |        |
| AEMRC-RD1003-D26-C25-L160-Z02       | ●   | 26  | 2    | 25 | 160 | 70   | 5   |           |              |             |             |        |              |        |
| AEMRC-RD1003-D32-W32-L150-Z03       | ●   | 32  | 3    | 32 | 150 | 60   | 5   |           |              |             |             |        |              |        |
| AEMRC-RD1003-D32-C32-L250-Z02       | ●   | 32  | 2    | 32 | 250 | 150  | 5   |           |              |             |             |        |              |        |
| AEMRC-RD1003-D33-C32-L160-Z03       | ●   | 33  | 3    | 32 | 160 | 70   | 5   |           |              |             |             |        |              |        |
| AEMRC-RD1003-D40-W32-L150-Z04       | ●   | 40  | 4    | 32 | 150 | 35   | 5   |           |              |             |             |        |              |        |
| AEMRC-RD1003-D40-C32-L250-Z02       | ●   | 40  | 2    | 32 | 250 | 50   | 5   |           |              |             |             |        |              |        |
| new AEMR-RD10T3-D20-C20-L180-Z02-H  | ●   | 20  | 2    | 20 | 180 | 60   | 5   |           |              |             | 4015-M3.5x9 |        |              |        |
| AEMRC-RD10T3-D20-C20-L150-Z02       | ●   | 20  | 2    | 20 | 150 | 60   | 5   |           | RD.. 10T3    | 4015-M3.5x9 | ACK-15      |        | 4015-M3.5x11 | 80-T15 |
| AEMRC-RD10T3-D20-W20-L150-Z02       | ●   | 20  | 2    | 20 | 150 | 60   | 5   |           |              |             |             |        |              |        |
| new AEMRC-RD10T3-D21-C20-L200-Z02-H | ●   | 21  | 2    | 20 | 200 | 80   | 5   |           |              |             |             |        |              |        |
| AEMRC-RD10T3-D25-C25-L150-Z02       | ●   | 25  | 2    | 25 | 150 | 60   | 5   |           |              |             |             |        |              |        |
| AEMRC-RD10T3-D25-C25-L200-Z02-H     | ●   | 25  | 2    | 25 | 200 | 100  | 5   |           |              |             |             |        |              |        |
| new AEMRC-RD10T3-D25-C32-L150-Z03   | ●   | 25  | 3    | 32 | 150 | 50   | 5   |           |              |             |             |        |              |        |
| AEMRC-RD10T3-D25-W25-L150-Z02       | ●   | 25  | 2    | 25 | 150 | 60   | 5   |           |              |             |             |        |              |        |
| new AEMRC-RD10T3-D26-C25-L200-Z02-H | ●   | 26  | 2    | 25 | 200 | 35   | 5   |           |              |             |             |        |              |        |
| AEMRC-RD10T3-D32-C25-L250-Z03-H     | ●   | 32  | 3    | 25 | 250 | 35   | 5   |           |              |             |             |        |              |        |
| AEMRC-RD10T3-D32-W32-L150-Z03       | ●   | 32  | 3    | 32 | 150 | 60   | 5   |           |              |             |             |        |              |        |
| new AEMRC-RD10T3-D32-C32-L150-Z04   | ●   | 32  | 4    | 32 | 150 | 60   | 5   |           |              |             |             |        |              |        |
| AEMRC-RD12T3-D25-W25-L150-Z02       | ●   | 25  | 2    | 25 | 150 | 60   | 6   | RD.. 12T3 |              |             |             | 80-T15 |              |        |
| AEMRC-RD12T3-D25-W25-L200-Z02       | ●   | 25  | 2    | 25 | 200 | 100  | 6   |           |              |             |             |        |              |        |
| AEMRC-RD12T3-D25-C25-L250-Z02       | ●   | 25  | 2    | 25 | 250 | 150  | 6   |           |              |             |             |        |              |        |
| AEMRC-RD12T3-D25-C25-L300-Z02       | ●   | 25  | 2    | 25 | 300 | 200  | 6   |           |              |             |             |        |              |        |
| AEMRC-RD12T3-D32-W32-L150-Z03       | ●   | 32  | 3    | 32 | 150 | 60   | 6   |           |              |             |             |        |              |        |
| AEMRC-RD12T3-D32-C32-L250-Z02       | ●   | 32  | 2    | 32 | 250 | 150  | 6   |           |              |             |             |        |              |        |
| AEMRC-RD12T3-D40-W32-L150-Z04       | ●   | 40  | 4    | 32 | 150 | 50   | 6   |           |              |             |             |        |              |        |
| AEMRC-RD12T3-D40-C32-L250-Z02       | ●   | 40  | 2    | 32 | 250 | 50   | 6   |           |              |             |             |        |              |        |
| new AEMRC-RD1204-D32-C32-L200-Z02   | ●   | 32  | 2    | 32 | 200 | 100  | 6   | RD.. 1204 |              |             |             | 80-T15 |              |        |
| AEMRC-RD1204-D32-C32-L160-Z03       | ●   | 32  | 3    | 32 | 160 | 70   | 6   |           |              |             |             |        |              |        |
| AEMRC-RD1204-D32-W32-L160-Z03       | ●   | 32  | 3    | 32 | 160 | 70   | 6   |           |              |             |             |        |              |        |
| AEMRC-RD1204-D33-C32-L160-Z03       | ●   | 33  | 3    | 32 | 160 | 70   | 6   |           |              |             |             |        |              |        |
| new AEMRC-RD1204-D32-C32-L160-Z03-H | ●   | 32  | 3    | 32 | 160 | 70   | 6   | RD.. 1604 | 4015-M4.5x11 | ACK-05      | 4015-M4x11  | 80-T15 |              |        |
| AEMRC-RD1604-D40-W32-L150-Z02       | ●   | 40  | 2    | 32 | 150 | 35   | 8   |           |              |             |             |        |              |        |

R: Sağ / Right / Rechts/ L: Sol / Left / Links

● Stokta / In Stock / Auf Lager ○ Stokta Yok / Non Stock Item / Kein Lagerartikel, Lieferzeit auf Anfrage  
ISO Ucuuna Uygundur. / Compatible with ISO Insert. / Kompatibel mit ISO Wendeplatten.

Sipariş Örneği/Ordering Example/Bestellbeispiel

1 ad./pcs./шт. AEMR-RD0501-D08-W10-L100-Z01-H

Kesme Hesabı : S 377/ Cutting Calculation : P 377 / Schnittberechnung : P 377

**S-SİSTEM YÜZEY ve KOPYA PARMAK FREZELER**  
**S-SYSTEM FACE and COPY END MILLS**  
**S-SYSTEM KOPIER- UND SCHAFTFRÄSER**

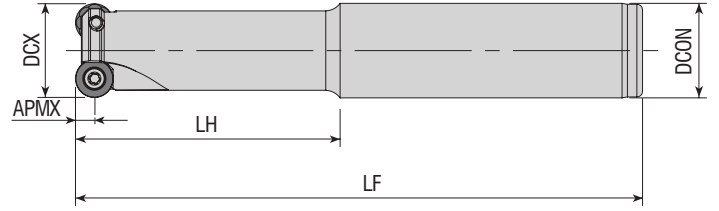

| Takım Kodu<br>Ordering Code<br>Bestell-Bezeichnung | Stok<br>Stock<br>Lager | Takım Ölçüleri (mm)<br>Dimension (mm)<br>Abmessung (mm) |      |      |     |    |      | Kesici Uç<br>Insert<br>Wendeschneidplatte | Yedek Parçaları / Spare Parts / Ersatzteile |   |   |  |
|--|------------------------|---|------|------|-----|----|------|---|---|---|---|--|
|  |                        | DCX   | ZEFP | DCON | LF  | LH | APMX |   | Sıkma Vidası<br>Screw<br>Schraube           | Baskı Parçası<br>Wedge Clamp<br>Spannpratze | Baskı Vidası<br>Clamp Screw<br>Schraube | Tork Anahtar<br>Torx Key<br>Torx-Schlüssel |
| AEMR-QP10T3-D20-C20-L150-Z01-H                     | ●                      | 20  | 1    | 20   | 150 | 70 | 5    | QP. 10T3..                                | 4015-M3.5x9                                 | -   | -                                       | 80-T15                                     |
| AEMR-QP10T3-D25-C25-L120-Z02-H                     | ●                      | 25  | 2    | 25   | 120 | 40 | 5    |   |   |   |   |  |
| AEMR-QP10T3-D25-C25-L150-Z02-H                     | ●                      | 25  | 2    | 25   | 150 | 70 | 5    |   |   |   |   |  |
| AEMR-QP10T3-D25-C25-L170-Z02                       | ●                      | 25  | 2    | 25   | 170 | 90 | 5    |   |   |   |   |  |
| AEMR-QP10T3-D32-C32-L150-Z03-H                     | ●                      | 32  | 3    | 32   | 150 | 70 | 5    |   |   |   |   |  |
| AEMR-QP10T3-D32-C32-L170-Z03                       | ●                      | 32  | 3    | 32   | 170 | 90 | 5    |   |   |   |   |  |
| AEMR-QP1204-D25-C25-L150-Z02-H                     | ●                      | 25  | 2    | 25   | 150 | 70 | 6    | QP. 1204..                                | 4015-M4x9                                   | -   | -                                       |  |

SMTM Ucuna Uygundur. / Compatible with SMTM Insert. / Kompatibel mit SMTM Wendepfatten.

**S-SİSTEM HIZLI İLERLEMELİ PARMAK FREZELER**  
**S-SYSTEM HIGHFEED END MILLS**  
**S-SYSTEM HOCHVORSCHUB- SCHAFTFRÄSER**

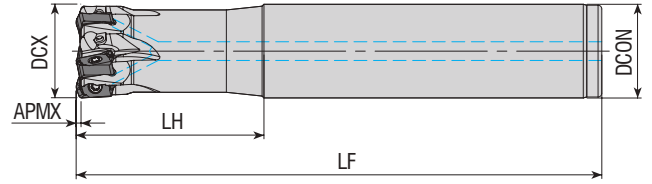

| Takım Kodu<br>Ordering Code<br>Bestell-Bezeichnung | Stok<br>Stock<br>Lager | Takım Ölçüleri (mm)<br>Dimension (mm)<br>Abmessung (mm) |      |      |     |     |      | Kesici Uç<br>Insert<br>Wendeschneidplatte | Yedek Parçaları / Spare Parts / Ersatzteile |  |
|--|------------------------|---|------|------|-----|-----|------|---|---|--|
|  |                        | DCX   | ZEFP | DCON | LF  | LH  | APMX |   | Sıkma Vidası<br>Screw<br>Schraube           | Tork Anahtar<br>Torx Key<br>Torx-Schlüssel |
| AHFM-BN10T3-D16-C16-L100-Z02-H                     | ●                      | 16  | 2    | 16   | 100 | 30  | 1    | BNGX 10T3..                               | 3008-M2.5x6                                 | 82-T08                                     |
| AHFM-BN10T3-D16-C16-L150-Z02-H                     | ●                      | 16  | 2    | 16   | 150 | 50  | 1    |   |   |  |
| AHFM-BN10T3-D20-C20-L130-Z03-H                     | ●                      | 20  | 3    | 20   | 130 | 40  | 1    |   |   |  |
| AHFM-BN10T3-D20-C20-L130-Z04-H                     | ●                      | 20  | 4    | 20   | 130 | 40  | 1    |   |   |  |
| AHFM-BN10T3-D20-C20-L160-Z03-H                     | ●                      | 20  | 3    | 20   | 160 | 80  | 1    |   |   |  |
| AHFM-BN10T3-D25-C25-L140-Z04-H                     | ●                      | 25  | 4    | 25   | 140 | 50  | 1    |   |   |  |
| AHFM-BN10T3-D25-W25-L140-Z04-H                     | ●                      | 25  | 4    | 25   | 140 | 50  | 1    |   |   |  |
| AHFM-BN10T3-D25-C25-L140-Z05-H                     | ●                      | 25  | 5    | 25   | 140 | 50  | 1    |   |   |  |
| AHFM-BN10T3-D25-C25-L180-Z04-H                     | ●                      | 25  | 4    | 25   | 180 | 100 | 1    |   |   |  |
| AHFM-BN10T3-D32-C32-L150-Z05-H                     | ●                      | 32  | 5    | 32   | 150 | 70  | 1    |   |   |  |
| AHFM-BN10T3-D32-C32-L150-Z06-H                     | ●                      | 32  | 6    | 32   | 150 | 70  | 1    |   |   |  |
| AHFM-BN10T3-D35-C32-L200-Z06-H                     | ●                      | 35  | 6    | 32   | 200 | 50  | 1    |   |   |  |

R: Sağ / Right / Rechts / L: Sol / Left / Links

● Stokta / In Stock / Auf Lager ○ Stokta Yok / Non Stock Item / Kein Lagerartikel, Lieferzeit auf Anfrage

PRMT Ucuna Uygundur. / Compatible with PRMT Insert. / Kompatibel mit PRMT Wendepfatten.

Sipariş Örneği/Ordering Example/Bestellbeispiel

1 ad./pcs./stück AEMR-QP10T3-D20-C20-L150-Z01-H

Kesme Hesabı : S 377 / Cutting Calculation : P 377 / Schnittberechnung : P 377



www.akkо.com.tr

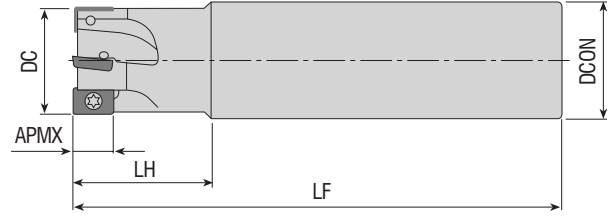

| Takım Kodu<br>Ordering Code<br>Bestell-Bezeichnung | Stok<br>Stock<br>Lager | Takım Ölçüleri (mm)<br>Dimension (mm)<br>Abmessung (mm) |      |      |     |    |      | Kesici Uç<br>Insert<br>Wendeschneidplatte | Yedek Parçaları / Spare Parts / Ersatzteile |  |  |
|--|------------------------|---|------|------|-----|----|------|---|---|--|--|
|  |                        | DC  | ZEFP | DCON | LF  | LH | APMX |   | Sıkma Vidası<br>Screw<br>Schraube           | Tork Anahtar<br>Torx Key<br>Torx-Schlüssel |  |
| AHFM-E00602-D10-C10-L080-Z02                       | ●                      | 10  | 2    | 10   | 80  | 20 | -    | EO.. 0602..<br>ZOMT 0602..                | 3006-M1.8x4                                 | 82-T06                                     |  |
| AHFM-E00602-D10-C09-L120-Z02                       | ●                      | 10  | 2    | 9    | 120 | 15 | -    |   |   |  |  |
| AHFM-E00602-D10-C10-L120-Z02                       | ●                      | 10  | 2    | 10   | 120 | 60 | -    |   |   |  |  |
| AHFM-E00602-D12-C12-L080-Z02                       | ●                      | 12  | 2    | 12   | 80  | 20 | -    |   |   |  |  |
| AHFM-E00602-D12-C12-L080-Z03                       | ●                      | 12  | 3    | 12   | 80  | 20 | -    |   |   |  |  |
| AHFM-E00602-D12-C11-L120-Z02                       | ●                      | 12  | 2    | 11   | 120 | 15 | -    |   |   |  |  |
| AHFM-E00602-D12-C11-L120-Z03                       | ●                      | 12  | 3    | 11   | 120 | 15 | -    |   |   |  |  |
| AHFM-E00602-D12-C12-L120-Z02                       | ●                      | 12  | 2    | 12   | 120 | 60 | -    |   |   |  |  |
| AHFM-E00602-D12-C12-L120-Z03                       | ●                      | 12  | 3    | 12   | 120 | 60 | -    |   |   |  |  |
| AHFM-E00602-D16-C16-L150-Z04                       | ●                      | 16  | 4    | 16   | 150 | 60 | -    |   |   |  |  |

DJT Ucuna Uygundur. / Compatible with DJT Insert. / Kompatibel mit DJT Wendeplatten.

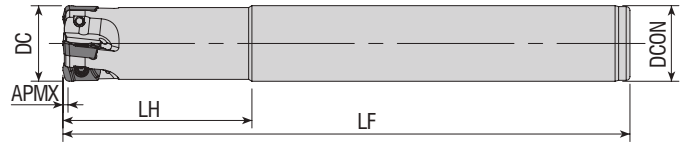

| Takım Kodu<br>Ordering Code<br>Bestell-Bezeichnung | Stok<br>Stock<br>Lager | Takım Ölçüleri (mm)<br>Dimension (mm)<br>Abmessung (mm) |      |      |     |     |      | Kesici Uç<br>Insert<br>Wendeschneidplatte | Yedek Parçaları / Spare Parts / Ersatzteile |  |  |
|--|------------------------|---|------|------|-----|-----|------|---|---|--|--|
|  |                        | DC  | ZEFP | DCON | LF  | LH  | APMX |   | Sıkma Vidası<br>Screw<br>Schraube           | Tork Anahtar<br>Torx Key<br>Torx-Schlüssel |  |
| new AHFM-EP1003-D16-C16-L80-Z02-H                  | ●                      | 16  | 2    | 16   | 80  | 20  | 1    | EP. 1003..<br>ZPMT 1003..<br>YPHW 1003..  | 3008-M2.5x5                                 | 82-T08                                     |  |
| AHFM-EP1003-D16-C16-L150-Z02-H                     | ●                      | 16  | 2    | 16   | 150 | 50  | 1    |   |   |  |  |
| AHFM-EP1003-D17-C16-L150-Z02-H                     | ●                      | 17  | 2    | 16   | 150 | 20  | 1    |   |   |  |  |
| AHFM-EP1003-D20-C20-L150-Z04-H                     | ●                      | 20  | 4    | 20   | 150 | 50  | 1    |   |   |  |  |
| AHFM-EP1003-D21-C20-L150-Z04-H                     | ●                      | 21  | 4    | 20   | 150 | 20  | 1    |   |   |  |  |
| AHFM-EP1003-D25-C25-L200-Z04-H                     | ●                      | 25  | 4    | 25   | 200 | 100 | 1    |   |   |  |  |
| AHFM-EP1003-D25-C25-L250-Z04-H                     | ●                      | 25  | 4    | 25   | 250 | 100 | 1    |   |   |  |  |

R: Sağ / Right / Rechts! L: Sol / Left / Links

● Stokta / In Stock / Auf Lager ○ Stokta Yok / Non Stock Item / Kein Lagerartikel, Lieferzeit auf Anfrage

DJT Ucuna Uygundur. / Compatible with DJT Insert. / Kompatibel mit DJT Wendeplatten.

Sipariş Örneği/Ordering Example/Bestellbeispiel

1 ad./pcs./stück AHFM-E00602-D10-C10-L080-Z02

Kesme Hesabı : S 377/ Cutting Calculation : P 377 / Schnittberechnung : P 377

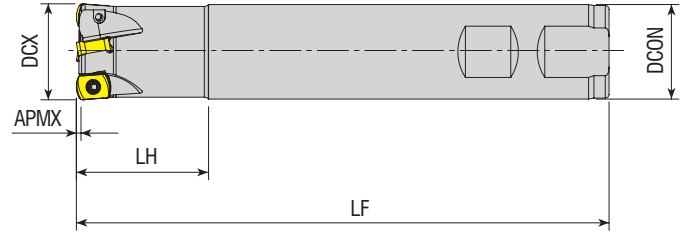

| Takım Kodu<br>Ordering Code<br>Bestell-Bezeichnung | Stok<br>Stock<br>Lager | Takım Ölçüleri (mm)<br>Dimension (mm)<br>Abmessung (mm) |      |      |     |     |      | Kesici Uç<br>Insert<br>Wendeschneidplatte | Yedek Parçaları / Spare Parts / Ersatzteile |  |  |
|--|------------------------|---|------|------|-----|-----|------|---|---|--|--|
|  |                        | DCX   | ZEFP | DCON | LF  | LH  | APMX |   | Sıkma Vidası<br>Screw<br>Schraube           | Tork Anahtar<br>Torx Key<br>Torx-Schlüssel |  |
| AHFM-BL0603-D16-C15-L150-Z02                       | ●                      | 16  | 2    | 15   | 150 | 20  | 1    | BLMP 0603..                               | 3008-M2.5x6                                 | 82-T08                                     |  |
| AHFM-BL0603-D16-C16-L100-Z02-H                     | ●                      | 16  | 2    | 16   | 100 | 30  | 1    |   |   |  |  |
| AHFM-BL0603-D16-C16-L150-Z02                       | ●                      | 16  | 2    | 16   | 150 | 50  | 1    |   |   |  |  |
| AHFM-BL0603-D17-C16-L150-Z02                       | ●                      | 17  | 2    | 16   | 150 | 20  | 1    |   |   |  |  |
| AHFM-BL0603-D17-W16-L170-Z02                       | ●                      | 17  | 2    | 16   | 170 | 20  | 1    |   |   |  |  |
| AHFM-BL0603-D17-W16-L170-Z02-H                     | ●                      | 17  | 2    | 16   | 170 | 20  | 1    |   |   |  |  |
| AHFM-BL0603-D17-C16-L200-Z02                       | ●                      | 17  | 2    | 16   | 200 | 30  | 1    |   |   |  |  |
| AHFM-BL0603-D18-C16-L150-Z02                       | ●                      | 18  | 2    | 16   | 150 | 20  | 1    |   |   |  |  |
| AHFM-BL0603-D18-W16-L150-Z02-H                     | ●                      | 18  | 2    | 16   | 150 | 20  | 1    |   |   |  |  |
| AHFM-BL0603-D20-C20-L130-Z03                       | ●                      | 20  | 3    | 20   | 130 | 50  | 1    |   |   |  |  |
| AHFM-BL0603-D20-C20-L160-Z03                       | ●                      | 20  | 3    | 20   | 160 | 50  | 1    |   |   |  |  |
| AHFM-BL0603-D21-C20-L200-Z03                       | ●                      | 21  | 3    | 20   | 200 | 25  | 1    |   |   |  |  |
| AHFM-BL0603-D21-W20-L200-Z03                       | ●                      | 21  | 3    | 20   | 200 | 25  | 1    |   |   |  |  |
| AHFM-BL0603-D22-W20-L150-Z03                       | ●                      | 22  | 3    | 20   | 150 | 20  | 1    |   |   |  |  |
| AHFM-BL0603-D25-C25-L250-Z04                       | ●                      | 25  | 4    | 25   | 250 | 40  | 1    |   |   |  |  |
| new AHFM-BL0603-D26-C25-L150-Z04                   | ●                      | 26  | 4    | 25   | 150 | 35  | 1    |   |   |  |  |
| AHFM-BL0603-D26-C25-L200-Z04                       | ●                      | 26  | 4    | 25   | 200 | 35  | 1    |   |   |  |  |
| AHFM-BL0603-D26-W25-L200-Z04                       | ●                      | 26  | 4    | 25   | 200 | 35  | 1    |   |   |  |  |
| AHFM-BL0603-D26-C25-L250-Z04                       | ●                      | 26  | 4    | 25   | 250 | 35  | 1    |   |   |  |  |
| AHFM-BL0603-D32-C32-L150-Z05                       | ●                      | 32  | 5    | 32   | 150 | 70  | 1    |   |   |  |  |
| AHFM-BL0603-D32-C32-L200-Z05                       | ●                      | 32  | 5    | 32   | 200 | 120 | 1    |   |   |  |  |
| AHFM-BL0603-D33-C32-L150-Z05                       | ●                      | 33  | 5    | 32   | 150 | 40  | 1    |   |   |  |  |
| AHFM-BL0603-D33-C32-L200-Z05                       | ●                      | 33  | 5    | 32   | 200 | 40  | 1    |   |   |  |  |
| AHFM-BL0603-D33-C32-L250-Z05                       | ●                      | 33  | 5    | 32   | 250 | 40  | 1    |   |   |  |  |
| new AHFM-BL0904-D28-W25-L180-Z03                   | ●                      | 28  | 3    | 25   | 180 | 30  | 1.5  | BLMP 0904..                               | 3010-M3.5x9                                 | 82-T10                                     |  |

R: Sağ / Right / Rechtsl L: Sol / Left / Links  
● Stokta / In Stock / Auf Lager ○ Stokta Yok / Non Stock Item / Kein Lagerartikel, Lieferzeit auf Anfrage  
TGTC Ucuna Uygunudur. / Compatible with TGTC Insert. / Kompatibel mit TGTC Wendeplatten.

Sipariş Örneği/Ordering Example/Bestellbeispiel  
1 ad./pcs./stück AHFM-BL0603-D16-C15-L150-Z02  
Kesme Hesabı : S 377/ Cutting Calculation : P 377 / Schnittberechnung : P 377



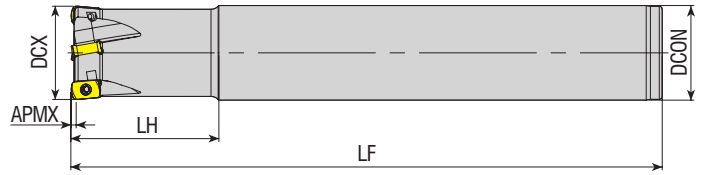

| Takım Kodu<br>Ordering Code<br>Bestell-Bezeichnung | Stok<br>Stock<br>Lager | Takım Ölçüleri (mm)<br>Dimension (mm)<br>Abmessung (mm) |      |      |     |    |      | Kesici Uç<br>Insert<br>Wendeschneidplatte | Yedek Parçaları / Spare Parts / Ersatzteile |  |  |
|--|------------------------|---|------|------|-----|----|------|---|---|--|--|
|  |                        | DCX   | ZEFP | DCON | LF  | LH | APMX |   | Sıkma Vidası<br>Screw<br>Schraube           | Tork Anahtar<br>Torx Key<br>Torx-Schlüssel |  |
| AHFM-EN1004-D16-C15-L150-Z02                       | ●                      | 16  | 2    | 15   | 150 | 25 | 1    | ENMU 1004..                               | 3008-M2.5x6                                 | 82-T08                                     |  |
| AHFM-EN1004-D16-C16-L150-Z02                       | ●                      | 16  | 2    | 16   | 150 | 25 | 1    |   |   |  |  |
| AHFM-EN1004-D16-C16-L250-Z02                       | ●                      | 16  | 2    | 16   | 250 | 70 | 1    |   |   |  |  |
| AHFM-EN1004-D17-C16-L150-Z02-H                     | ●                      | 17  | 2    | 16   | 150 | 25 | 1    |   |   |  |  |
| AHFM-EN1004-D17-C16-L150-Z02                       | ●                      | 17  | 2    | 16   | 150 | 25 | 1    |   |   |  |  |
| AHFM-EN1004-D17-C16-L200-Z02                       | ●                      | 17  | 2    | 16   | 200 | 25 | 1    |   |   |  |  |
| AHFM-EN1004-D18-C16-L150-Z02                       | ●                      | 18  | 2    | 16   | 150 | 25 | 1    |   |   |  |  |
| AHFM-EN1004-D20-C20-L150-Z03                       | ●                      | 20  | 3    | 20   | 150 | 40 | 1    |   |   |  |  |
| AHFM-EN1004-D20-C20-L250-Z03                       | ●                      | 20  | 3    | 20   | 250 | 70 | 1    |   |   |  |  |
| AHFM-EN1004-D21-C20-L150-Z02                       | ●                      | 21  | 2    | 20   | 150 | 30 | 1    |   |   |  |  |
| AHFM-EN1004-D21-C20-L150-Z03                       | ●                      | 21  | 3    | 20   | 150 | 30 | 1    |   |   |  |  |
| AHFM-EN1004-D21-C20-L150-Z03-H                     | ●                      | 21  | 3    | 20   | 150 | 30 | 1    |   |   |  |  |
| AHFM-EN1004-D21-C20-L200-Z03                       | ●                      | 21  | 3    | 20   | 200 | 30 | 1    |   |   |  |  |
| AHFM-EN1004-D22-C20-L150-Z03                       | ●                      | 22  | 3    | 20   | 150 | 30 | 1    |   |   |  |  |
| AHFM-EN1004-D25-C25-L150-Z03                       | ●                      | 25  | 3    | 25   | 150 | 40 | 1    |   |   |  |  |
| AHFM-EN1004-D25-C25-L150-Z04                       | ●                      | 25  | 4    | 25   | 150 | 40 | 1    |   |   |  |  |
| AHFM-EN1004-D26-C25-L150-Z03                       | ●                      | 26  | 3    | 25   | 150 | 30 | 1    |   |   |  |  |
| AHFM-EN1004-D26-C25-L150-Z04                       | ●                      | 26  | 4    | 25   | 150 | 30 | 1    |   |   |  |  |
| AHFM-EN1004-D26-C25-L200-Z03                       | ●                      | 26  | 3    | 25   | 200 | 30 | 1    |   |   |  |  |
| AHFM-EN1004-D26-C25-L200-Z03-H                     | ●                      | 26  | 3    | 25   | 200 | 30 | 1    |   |   |  |  |
| AHFM-EN1004-D26-C25-L250-Z03-H                     | ●                      | 26  | 3    | 25   | 250 | 30 | 1    |   |   |  |  |
| AHFM-EN1004-D28-C25-L200-Z04                       | ●                      | 28  | 4    | 25   | 200 | 30 | 1    |   |   |  |  |
| AHFM-EN1004-D32-C32-L200-Z04                       | ●                      | 32  | 4    | 32   | 200 | 50 | 1    |   |   |  |  |
| AHFM-EN1004-D33-C32-L200-Z04                       | ●                      | 33  | 4    | 32   | 200 | 30 | 1    |   |   |  |  |
| AHFM-EN1004-D33-C32-L200-Z04-H                     | ●                      | 33  | 4    | 32   | 200 | 30 | 1    |   |   |  |  |

R: Sağ / Right / Rechts/ L: Sol / Left / Links

● Stokta / In Stock / Auf Lager ○ Stokta Yok / Non Stock Item / Kein Lagerartikel, Lieferzeit auf Anfrage

DJT Ucuna Uygun. / Compatible with DJT Insert. / Kompatibel mit DJT Wendepalten.

Sipariş Örneği/Ordering Example/Bestellbeispiel

1 ad./pcs./stück AHFM-EN1004-D16-C15-L150-Z02

Kesme Hesabı : S 377/ Cutting Calculation : P 377 / Schnittberechnung : P 377



**S-SİSTEM HIZLI İLERLEMELİ PARMAK FREZELER**  
**S-SYSTEM HIGHFEED END MILLS**  
**S-SYSTEM HOCHVORSCHUB- SCHAFTFRÄSER**

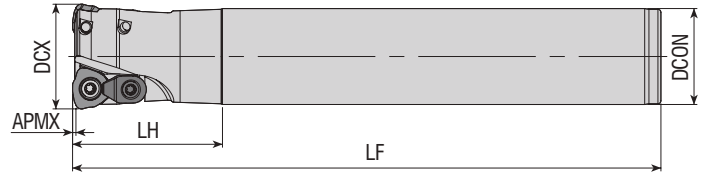

| Takım Kodu<br>Ordering Code<br>Bestell-Bezeichnung | Stok<br>Stock<br>Lager | Takım Ölçüleri (mm)<br>Dimension (mm)<br>Abmessung (mm) |      |      |     |    |      | Kesici Uç<br>Insert<br>Wendeschneidplatte | Yedek Parçaları / Spare Parts / Ersatzteile |   |   |  |
|--|------------------------|---|------|------|-----|----|------|---|---|---|---|--|
|  |                        | DCX   | ZEFP | DCON | LF  | LH | APMX |   | Sıkma Vidası<br>Screw<br>Schraube           | Baskı Parçası<br>Wedge Clamp<br>Spannpratze | Baskı Vidası<br>Clamp Screw<br>Schraube | Tork Anahtar<br>Torx Key<br>Torx-Schlüssel |
| AHFMC-JD1204-D32-C32-L150-Z02                      | ●                      | 32  | 2    | 32   | 150 | 50 | 1    | JDMW 1204..                               | 4615-M4x11                                  | ACK-05                                      | 4015-M4x11                              | 80-T15                                     |
| AHFMC-JD1204-D32-C32-L200-Z02                      | ●                      | 32  | 2    | 32   | 200 | 50 | 1    |   |   |   |   |  |
| AHFMC-JD1204-D35-C32-L200-Z02                      | ●                      | 35  | 2    | 32   | 200 | 50 | 1    |   |   |   |   |  |
| AHFMC-JD1204-D35-C32-L250-Z02                      | ●                      | 35  | 2    | 32   | 250 | 50 | 1    |   |   |   |   |  |

MTSBH Ucuna Uygunur. / Compatible with MTSBHInsert. / Kompatibel mit MTSBH Wendeplatten.

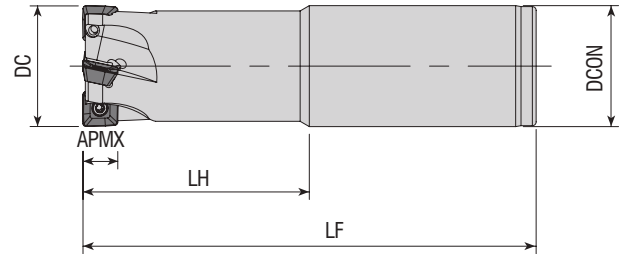

| Takım Kodu<br>Ordering Code<br>Bestell-Bezeichnung | Stok<br>Stock<br>Lager | Takım Ölçüleri (mm)<br>Dimension (mm)<br>Abmessung (mm) |      |      |     |    |      | Kesici Uç<br>Insert<br>Wendeschneidplatte | Yedek Parçaları / Spare Parts / Ersatzteile |  |
|--|------------------------|---|------|------|-----|----|------|---|---|--|
|  |                        | DCX   | ZEFP | DCON | LF  | LH | APMX |   | Sıkma Vidası<br>Screw<br>Schraube           | Tork Anahtar<br>Torx Key<br>Torx-Schlüssel |
| AHFM-SP0735-D16-C16-L160-Z02-H                     | ●                      | 16  | 2    | 16   | 160 | 30 | 1.2  | SPMX 073505                               | 3108-M3x6                                   | 82-T08                                     |
| AHFM-SP0735-D17-C16-L160-Z02-H                     | ●                      | 17  | 2    | 16   | 160 | 30 | 1.2  |   |   |  |
| AHFM-SP0735-D20-C20-L160-Z03-H                     | ●                      | 20  | 2    | 20   | 160 | 30 | 1.2  |   |   |  |
| AHFM-SP0735-D21-C20-L160-Z03-H                     | ●                      | 21  | 2    | 20   | 160 | 30 | 1.2  |   |   |  |

R: Sağ / Right / Rechts! L: Sol / Left / Links  
 ● Stokta / In Stock / Auf Lager ○ Stokta Yok / Non Stock Item / Kein Lagerartikel, Lieferzeit auf Anfrage  
 MTSBH Ucuna Uygunur. / Compatible with MTSBH Insert. / Kompatibel mit MTSBH Wendeplatten.

Sipariş Örneği/Ordering Example/Bestellbeispiel  
 1 ad./pcs./stück AHFMC-JD1204-D32-C32-L150-Z02  
 Kesme Hesabı : S 377/ Cutting Calculation : P 377 | Schnittberechnung : P 377

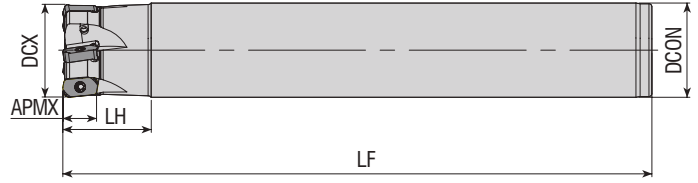

| Takım Kodu<br>Ordering Code<br>Bestell-Bezeichnung | Stok<br>Stock<br>Lager | Takım Ölçüleri (mm)<br>Dimension (mm)<br>Abmessung (mm) |      |      |     |    |      | Kesici Uç<br>Insert<br>Wendeschneidplatte | Yedek Parçaları / Spare Parts / Ersatzteile |  |  |
|--|------------------------|---|------|------|-----|----|------|---|---|--|--|
|  |                        | DCX   | ZEFP | DCON | LF  | LH | APMX |   | Sıkma Vidası<br>Screw<br>Schraube           | Tork Anahtar<br>Torx Key<br>Torx-Schlüssel |  |
| AHFM-LN0303-D16-C15-L150-Z02                       | ●                      | 16  | 2    | 15   | 150 | 30 | 12   | LNMU 0303..                               | 3008-M2.5x6                                 | 82-T08                                     |  |
| AHFM-LN0303-D16-W16-L150-Z02-H                     | ●                      | 16  | 2    | 16   | 150 | 50 | 12   |   |   |  |  |
| <b>new</b> AHFM-LN0303-D17-C16-L150-Z02-H          | ●                      | 17  | 2    | 16   | 150 | 30 | 12   |   |   |  |  |
| AHFM-LN0303-D20-W20-L150-Z03-H                     | ●                      | 20  | 3    | 20   | 150 | 50 | 12   |   |   |  |  |
| AHFM-LN0303-D21-C20-L150-Z03                       | ●                      | 21  | 3    | 20   | 150 | 30 | 12   |   |   |  |  |
| AHFM-LN0303-D25-W25-L150-Z04-H                     | ●                      | 25  | 4    | 25   | 150 | 50 | 12   |   |   |  |  |
| AHFM-LN0303-D26-C25-L150-Z04                       | ●                      | 26  | 4    | 25   | 150 | 30 | 12   |   |   |  |  |
| <b>new</b> AHFM-LN0303-D28-C25-L180-Z03            | ●                      | 28  | 3    | 25   | 180 | 30 | 12   |   |   |  |  |
| AHFM-LN0303-D33-C32-L200-Z05                       | ●                      | 33  | 5    | 32   | 200 | 30 | 12   |   |   |  |  |

TNGLY Ucuna Uygun. / Compatible with TNGLY Insert. / Kompatibel mit TNGLY Wendeplatten.

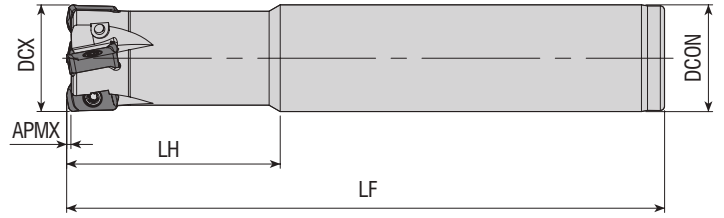

| Takım Kodu<br>Ordering Code<br>Bestell-Bezeichnung | Stok<br>Stock<br>Lager | Takım Ölçüleri (mm)<br>Dimension (mm)<br>Abmessung (mm) |      |      |     |     |      | Kesici Uç<br>Insert<br>Wendeschneidplatte | Yedek Parçaları / Spare Parts / Ersatzteile |  |  |
|--|------------------------|---|------|------|-----|-----|------|---|---|--|--|
|  |                        | DCX   | ZEFP | DCON | LF  | LH  | APMX |   | Sıkma Vidası<br>Screw<br>Schraube           | Tork Anahtar<br>Torx Key<br>Torx-Schlüssel |  |
| AHFM-L003-D16-C15-L160-Z02                         | ●                      | 16  | 2    | 15   | 160 | 30  | 1    | LOGU 0303..                               | 1108-M3x6.8                                 | 82-T08                                     |  |
| AHFM-L003-D16-C16-L100-Z02-F                       | ●                      | 16  | 2    | 16   | 100 | 30  | 1    |   |   |  |  |
| AHFM-L003-D16-C16-L100-Z02                         | ●                      | 16  | 2    | 16   | 100 | 30  | 1    |   |   |  |  |
| AHFM-L003-D16-C16-L130-Z02-H                       | ●                      | 16  | 2    | 16   | 130 | 40  | 1    |   |   |  |  |
| AHFM-L003-D16-C16-L160-Z02                         | ●                      | 16  | 2    | 16   | 160 | 50  | 1    |   |   |  |  |
| AHFM-L003-D16-C16-L160-Z02-H                       | ●                      | 16  | 2    | 16   | 160 | 100 | 1    |   |   |  |  |
| AHFM-L003-D17-C16-L180-Z02                         | ●                      | 17  | 2    | 16   | 180 | 30  | 1    |   |   |  |  |
| AHFM-L003-D20-C20-L130-Z03                         | ●                      | 20  | 3    | 20   | 130 | 40  | 1    |   |   |  |  |
| AHFM-L003-D20-C20-L130-Z03-H                       | ●                      | 20  | 3    | 20   | 130 | 40  | 1    |   |   |  |  |
| AHFM-L003-D20-C20-L160-Z03                         | ●                      | 20  | 3    | 20   | 160 | 80  | 1    |   |   |  |  |
| AHFM-L003-D20-C20-L160-Z03-H                       | ●                      | 20  | 3    | 20   | 160 | 100 | 1    |   |   |  |  |
| AHFM-L003-D21-C20-L150-Z03-H                       | ●                      | 21  | 3    | 20   | 150 | 30  | 1    |   |   |  |  |
| AHFM-L003-D21-C20-L200-Z03                         | ●                      | 21  | 3    | 20   | 200 | 30  | 1    |   |   |  |  |
| AHFM-L003-D21-C20-L200-Z03-H                       | ●                      | 21  | 3    | 20   | 200 | 30  | 1    |   |   |  |  |
| AHFM-L003-D25-C25-L140-Z04-F                       | ●                      | 25  | 4    | 25   | 140 | 50  | 1    |   |   |  |  |
| AHFM-L003-D25-C25-L140-Z04                         | ●                      | 25  | 4    | 25   | 140 | 50  | 1    |   |   |  |  |
| AHFM-L003-D25-C25-L180-Z04                         | ●                      | 25  | 4    | 25   | 180 | 100 | 1    |   |   |  |  |
| AHFM-L003-D26-C25-L250-Z04                         | ●                      | 26  | 4    | 25   | 250 | 40  | 1    |   |   |  |  |
| AHFM-L003-D32-C32-L200-Z05                         | ●                      | 32  | 5    | 32   | 200 | 120 | 1    |   |   |  |  |
| AHFM-L003-D33-C32-L250-Z05                         | ●                      | 33  | 5    | 32   | 250 | 40  | 1    |   |   |  |  |

R: Sağ / Right / Rechts/ L: Sol / Left / Links

● Stokta / In Stock / Auf Lager ○ Stokta Yok / Non Stock Item / Kein Lagerartikel, Lieferzeit auf Anfrage

KYCR Ucuna Uygun. / Compatible with KYCR Insert. / Kompatibel mit KYCR Wendeplatten.

F: Eksenel ve Radyal Salgı Değeri 0,02 mm içindedir. / F: Axial and Radial Runout Value is within 0,02 mm.

F: Der axiale und radiale Rundlaufwert liegt innerhalb von 0,02 mm.

Sipariş Örneği/Ordering Example/Bestellbeispiel

1 ad./pcs./stück AHFM-LN0303-D16-C15-L150-Z02

Kesme Hesabı : S 377/ Cutting Calculation : P 377 / Schnittberechnung : P 377

# S-SİSTEM HIZLI İLERLEMELİ PARMAK FREZELER

S-SYSTEM HIGHFEED END MILLS

S-SYSTEM HOCHVORSCHUB- SCHAFTFRÄSER

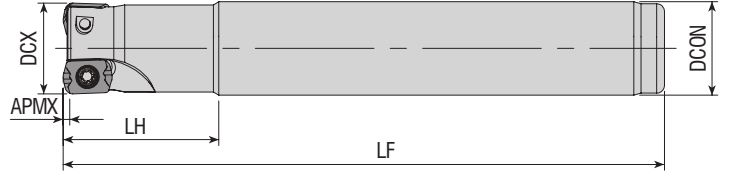

| Takım Kodu<br>Ordering Code<br>Bestell-Bezeichnung | Stok<br>Stock<br>Lager | Takım Ölçüleri (mm)<br>Dimension (mm)<br>Abmessung (mm) |      |      |     |    |      | Kesici Uç<br>Insert<br>Wendeschneidplatte | Yedek Parçaları / Spare Parts / Ersatzteile |  |  |
|--|------------------------|---|------|------|-----|----|------|---|---|--|--|
|  |                        | DCX   | ZEFP | DCON | LF  | LH | APMX |   | Sıkma Vidası<br>Screw<br>Schraube           | Tork Anahtar<br>Torx Key<br>Torx-Schlüssel |  |
| AHFM-LP0102-D10-C09-L120-Z02                       | ●                      | 10  | 2    | 9    | 120 | 20 | 0.5  | LPGT 0102..                               |   | 82-T06                                     |  |
| AHFM-LP0102-D10-C10-L120-Z02                       | ●                      | 10  | 2    | 10   | 120 | 20 | 0.5  |   |   |  |  |
| AHFM-LP0102-D12-C11-L120-Z02                       | ●                      | 12  | 2    | 11   | 120 | 20 | 0.5  |   |   |  |  |
| AHFM-LP0102-D12-C12-L120-Z02                       | ●                      | 12  | 2    | 12   | 120 | 20 | 0.5  |   |   |  |  |

KYCR Ucuna Uygunur. / Compatible with KYCR Insert. / Kompatibel mit KYCR Wendeplatten.

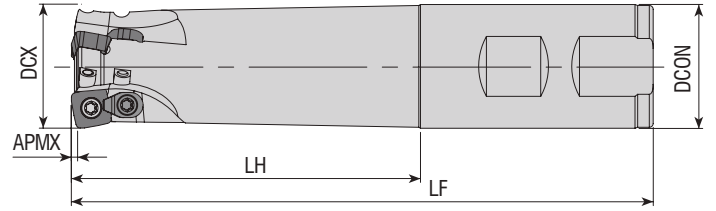

| Takım Kodu<br>Ordering Code<br>Bestell-Bezeichnung | Stok<br>Stock<br>Lager | Takım Ölçüleri (mm)<br>Dimension (mm)<br>Abmessung (mm) |      |      |     |     |      | Kesici Uç<br>Insert<br>Wendeschneidplatte | Yedek Parçaları / Spare Parts / Ersatzteile |   |   |  |
|--|------------------------|---|------|------|-----|-----|------|---|---|---|---|--|
|  |                        | DCX   | ZEFP | DCON | LF  | LH  | APMX |   | Sıkma Vidası<br>Screw<br>Schraube           | Baskı Parçası<br>Wedge Clamp<br>Spannpratze | Baskı Vidası<br>Clamp Screw<br>Schraube | Tork Anahtar<br>Torx Key<br>Torx-Schlüssel |
| AHFM-SD06T2-D16-C16-L100-Z02-H                     | ●                      | 16  | 2    | 16   | 100 | 50  | 0.8  | SD.. 06T2..                               |   |   |   | 82-T07                                     |
| AHFM-SD06T2-D16-C16-L150-Z02-H                     | ●                      | 16  | 2    | 16   | 150 | 50  | 0.8  |   |   |   |   |  |
| AHFM-SD06T2-D16-C16-L200-Z02                       | ●                      | 16  | 2    | 16   | 200 | 100 | 0.8  |   |   |   |   |  |
| AHFM-SD06T2-D17-C16-L150-Z02-H                     | ●                      | 17  | 2    | 16   | 150 | 50  | 0.8  |   |   |   |   |  |
| AHFM-SD06T2-D20-C20-L150-Z03-H                     | ●                      | 20  | 3    | 20   | 150 | 50  | 0.8  |   |   |   |   |  |
| AHFM-SD06T2-D20-C20-L200-Z03                       | ●                      | 20  | 3    | 20   | 200 | 100 | 0.8  |   |   |   |   |  |
| AHFM-SD06T2-D21-C20-L150-Z03-H                     | ●                      | 21  | 3    | 20   | 150 | 50  | 0.8  |   |   |   |   |  |
| AHFM-SD06T2-D25-C25-L150-Z04-H                     | ●                      | 25  | 4    | 25   | 150 | 60  | 0.8  |   |   |   |   |  |
| AHFM-SD06T2-D26-C25-L150-Z04-H                     | ●                      | 26  | 4    | 25   | 150 | 60  | 0.8  |   |   |   |   |  |
| AHFMC-SD09T3-D22-W20-L150-Z02                      | ●                      | 22  | 2    | 20   | 150 | 30  | 1.4  |   |   |   |   |  |
| AHFMC-SD09T3-D25-C25-L150-Z02                      | ●                      | 25  | 2    | 25   | 150 | 94  | 1.4  |   |   |   |   |  |
| AHFMC-SD09T3-D25-W25-L150-Z02                      | ●                      | 25  | 2    | 25   | 150 | 94  | 1.4  |   |   |   |   |  |
| AHFMC-SD09T3-D28-C25-L150-Z02                      | ●                      | 28  | 2    | 25   | 150 | 30  | 1.4  |   |   |   |   |  |
| AHFMC-SD09T3-D32-C32-L150-Z03                      | ●                      | 32  | 3    | 32   | 150 | 100 | 1.4  |   |   |   |   |  |
| AHFMC-SD09T3-D32-W32-L150-Z03                      | ●                      | 32  | 3    | 32   | 150 | 90  | 1.4  |   |   |   |   |  |
| AHFMC-SD09T3-D25-C25-L150-Z03                      | ●                      | 25  | 3    | 25   | 150 | 60  | 1.4  |   |   |   |   |  |
| AHFMC-SD09T3-D32-C32-L150-Z04                      | ●                      | 32  | 4    | 25   | 150 | 60  | 1.4  |   |   |   |   |  |

R: Sağ / Right / Rechts L: Sol / Left / Links

● Stokta / In Stock / Auf Lager ○ Stokta Yok / Non Stock Item / Kein Lagerartikel, Lieferzeit auf Anfrage  
ZCC Ucuna Uygunur. / Compatible with ZCC Insert. / Kompatibel mit ZCC Wendeplatten.

Sipariş Örneği/Ordering Example/Bestellbeispiel

1 ad./pcs./stück AHFM-LP0102-D10-C09-L120-Z02

Kesme Hesabı : S 377/ Cutting Calculation : P 377 / Schnittberechnung : P 377



www.akkо.com.tr

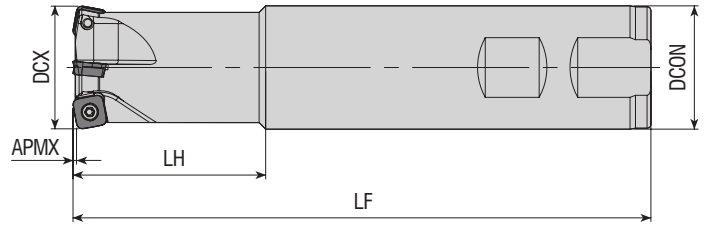

| Takım Kodu<br>Ordering Code<br>Bestell-Bezeichnung | Stok<br>Stock<br>Lager | Takım Ölçüleri (mm)<br>Dimension (mm)<br>Abmessung (mm) |      |      |     |    |      | Kesici Uç<br>Insert<br>Wendeschneidplatte | Yedek Parçaları / Spare Parts / Ersatzteile |  |  |
|--|------------------------|---|------|------|-----|----|------|---|---|--|--|
|  |                        | DCX   | ZEFP | DCON | LF  | LH | APMX |   | Sıkma Vidası<br>Screw<br>Schraube           | Tork Anahtar<br>Torx Key<br>Torx-Schlüssel |  |
| AHFM-S00803-D20-W20-L150-Z02                       | ●                      | 20  | 2    | 20   | 150 | 50 | -    | SOMW 0803..                               |   | 4010-M3x8                                  |  |
| AHFM-S00803-D25-W25-L150-Z03                       | ●                      | 25  | 3    | 25   | 150 | 50 | -    |   |   |  |  |
| AHFM-S00803-D32-W32-L150-Z04                       | ●                      | 32  | 4    | 32   | 150 | 50 | -    |   |   |  |  |

KPTK Ucuna Uygun. / Compatible with KPTK Insert. / Kompatibel mit KPTK Wendepfatten.

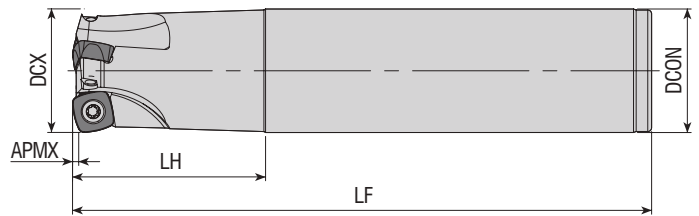

| Takım Kodu<br>Ordering Code<br>Bestell-Bezeichnung | Stok<br>Stock<br>Lager | Takım Ölçüleri (mm)<br>Dimension (mm)<br>Abmessung (mm) |      |      |     |    |      | Kesici Uç<br>Insert<br>Wendeschneidplatte | Yedek Parçaları / Spare Parts / Ersatzteile |  |  |
|--|------------------------|---|------|------|-----|----|------|---|---|--|--|
|  |                        | DCX   | ZEFP | DCON | LF  | LH | APMX |   | Sıkma Vidası<br>Screw<br>Schraube           | Tork Anahtar<br>Torx Key<br>Torx-Schlüssel |  |
| AHFM-SP1004-D25-C25-L150-Z02                       | ●                      | 25  | 2    | 25   | 150 | 50 | 1.5  | SPNW 1004..                               |   | 3015-M3.5x9                                |  |
| AHFM-SP1004-D32-C32-L150-Z03                       | ●                      | 32  | 3    | 32   | 150 | 50 | 1.5  |   |   |  |  |

R: Sağ / Right / Rechts/ L: Sol / Left / Links

● Stokta / In Stock / Auf Lager ○ Stokta Yok / Non Stock Item / Kein Lagerartikel, Lieferzeit auf Anfrage  
DJT Ucuna Uygun. / Compatible with DJT Insert. / Kompatibel mit DJT Wendepfatten.



Sipariş Örneği/Ordering Example/Bestellbeispiel

1 ad./pcs./stück AHFM-S00803-D20-W20-L150-Z02

Kesme Hesabı : S 377/ Cutting Calculation : P 377 / Schnittberechnung : P 377

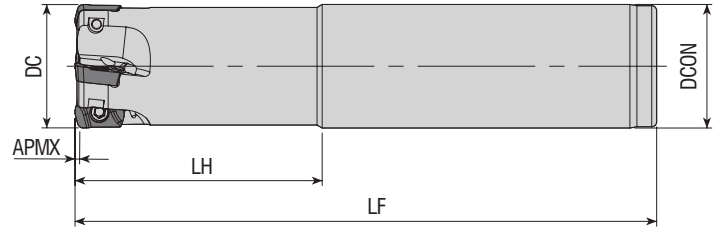
**S-SİSTEM HIZLI İLERLEMELİ PARMAK FREZELER**  
**S-SYSTEM HIGHFEED END MILLS**  
**S-SYSTEM HOCHVORSCHUB- SCHAFTFRÄSER**

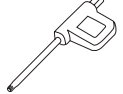

| Takım Kodu<br>Ordering Code<br>Bestell-Bezeichnung | Stok<br>Stock<br>Lager | Takım Ölçüleri (mm)<br>Dimension (mm)<br>Abmessung (mm) |      |      |     |    |      | Kesici Uç<br>Insert<br>Wendeschneidplatte  | Yedek Parçaları / Spare Parts / Ersatzteile  |   |
|--|------------------------|---|------|------|-----|----|------|--|--|---|
|  |                        | DC  | ZEFP | DCON | LF  | LH | APMX |  | Sıkma Vidası<br>Screw<br>Schraube  | Tork Anahtar<br>Torx Key<br>Torx-Schlüssel  |
| AHFM-YP1003-D16-C15-L150-Z02-F                     | ●                      | 16  | 2    | 15   | 150 | 20 | 1    | <br><b>EP. 1003..</b><br><b>YPHW 1003..</b><br><b>ZPMT 1003..</b> | <br>3008-M2.5x5 | <br>82-T08 |
| AHFM-YP1003-D16-C15-L200-Z02-F                     | ●                      | 16  | 2    | 15   | 200 | 20 | 1    |  |  |   |
| AHFM-YP1003-D16-C16-L150-Z02-F                     | ●                      | 16  | 2    | 16   | 150 | 50 | 1    |  |  |   |
| AHFM-YP1003-D17-C16-L150-Z02-F                     | ●                      | 17  | 2    | 16   | 150 | 20 | 1    |  |  |   |
| AHFM-YP1003-D17-C16-L200-Z02-F                     | ●                      | 17  | 2    | 16   | 200 | 20 | 1    |  |  |   |
| AHFM-YP1003-D20-C18-L150-Z03-F                     | ●                      | 20  | 3    | 18   | 150 | 25 | 1    |  |  |   |
| AHFM-YP1003-D20-C18-L200-Z03-F                     | ●                      | 20  | 3    | 18   | 200 | 25 | 1    |  |  |   |
| AHFM-YP1003-D20-C20-L150-Z03-F                     | ●                      | 20  | 3    | 20   | 150 | 50 | 1    |  |  |   |
| AHFM-YP1003-D21-C20-L150-Z03-F                     | ●                      | 21  | 3    | 20   | 150 | 20 | 1    |  |  |   |
| AHFM-YP1003-D21-C20-L150-Z03-H                     | ●                      | 21  | 3    | 20   | 150 | 20 | 1    |  |  |   |
| AHFM-YP1003-D21-C20-L150-Z04-F                     | ●                      | 21  | 4    | 20   | 150 | 20 | 1    |  |  |   |
| AHFM-YP1003-D21-C20-L200-Z03                       | ●                      | 21  | 3    | 20   | 200 | 20 | 1    |  |  |   |
| AHFM-YP1003-D21-C20-L200-Z03-F                     | ●                      | 21  | 3    | 20   | 200 | 20 | 1    |  |  |   |
| AHFM-YP1003-D25-C20-L150-Z04-F                     | ●                      | 25  | 4    | 20   | 150 | 25 | 1    |  |  |   |
| AHFM-YP1003-D25-C20-L200-Z04-F                     | ●                      | 25  | 4    | 20   | 200 | 25 | 1    |  |  |   |
| AHFM-YP1003-D25-C25-L150-Z04-F                     | ●                      | 25  | 4    | 25   | 150 | 50 | 1    |  |  |   |
| AHFM-YP1003-D26-C25-L150-Z04                       | ●                      | 26  | 4    | 25   | 150 | 30 | 1    |  |  |   |
| <b>new</b> AHFM-YP1003-D25-C25-L150-Z04-H          | ●                      | 25  | 4    | 25   | 150 | 50 | 1    |  |  |   |
| AHFM-YP1003-D26-C25-L150-Z04-F                     | ●                      | 26  | 4    | 25   | 150 | 30 | 1    |  |  |   |
| <b>new</b> AHFM-YP1003-D26-C25-L250-Z04-F          | ●                      | 26  | 4    | 25   | 250 | 30 | 1    |  |  |   |
| AHFM-YP1003-D26-C25-L200-Z03-F                     | ●                      | 26  | 3    | 25   | 200 | 30 | 1    |  |  |   |
| AHFM-YP1003-D26-C25-L200-Z04-F                     | ●                      | 26  | 4    | 25   | 200 | 30 | 1    |  |  |   |
| <b>new</b> AHFM-YP1003-D33-C32-L200-Z04-F          | ●                      | 33  | 4    | 32   | 200 | 30 | 1    |  |  |   |
| <b>new</b> AHFM-YP1003-D33-C32-L250-Z04-F          | ●                      | 33  | 4    | 32   | 250 | 30 | 1    |  |  |   |
| <b>new</b> AHFM-YP1003-D33-C32-L300-Z04-F          | ●                      | 33  | 4    | 32   | 300 | 30 | 1    |  |  |   |

R: Sağ / Right / Rechts/ L: Sol / Left / Links

● Stokta / In Stock / Auf Lager ○ Stokta Yok / Non Stock Item / Kein Lagerartikel, Lieferzeit auf Anfrage

DJT Ucuna Uygunudur. / Compatible with DJT Insert. / Kompatibel mit DJT Wendepplatten.

Çap Ölçüsü - 0,02 mm Olarak üretiliyor. F: ± 0,02 mm Demektir. Ör: Ø16 Takım 15,98 ± 0,02 mm yani 16,00 mm - 15,96 mm Olmalıdır.

Diameter Size is produced as - 0.02 mm. F: means ± 0,02 mm. For example: Ø16 tool 15.98 ± 0,02 mm, it means that it should be 16,00 mm - 15,96 mm.

Durchmesser - Es wird mit -0,02 mm hergestellt. Das heißt F: ± 0,02 mm. Zum Beispiel: Der Ø16-Satz sollte 15,98 ± 0,02 mm, 16,00 mm - 15,96 mm betragen.

Sipariş Örneği/Ordering Example/Bestellbeispiel

1 ad./pcs./stück AHFM-YP1003-D16-C15-L150-Z02-F

Kesme Hesabı : S 377/ Cutting Calculation : P 377 / Schnittberechnung : P 377



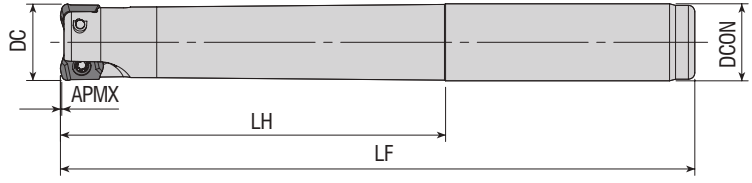

| Takım Kodu<br>Ordering Code<br>Bestell-Bezeichnung | Stok<br>Stock<br>Lager | Takım Ölçüleri (mm)<br>Dimension (mm)<br>Abmessung (mm) |      |      |     |    |      | Kesici Uç<br>Insert<br>Wendeschneidplatte | Yedek Parçaları / Spare Parts / Ersatzteile |   |  |
|--|------------------------|---|------|------|-----|----|------|---|---|---|--|
|  |                        | DC  | ZEFP | DCON | LF  | LH | APMX |   | Sıkma Vidası<br>Screw<br>Schraube           | Baskı Parçası<br>Wedge Clamp<br>Spannpratze | Tork Anahtar<br>Torx Key<br>Torx-Schlüssel |
| AHFM-Y00602-D10-C09-L120-Z02-F                     | ●                      | 10  | 2    | 9    | 120 | 15 | 0.3  | YOHW 0602..                               | 3006-M1.8X4                                 | 82-T06                                      |  |
| AHFM-Y00602-D10-C10-L080-Z02-F                     | ●                      | 10  | 2    | 10   | 80  | 20 | 0.3  |   |   |   |  |
| AHFM-Y00602-D10-C10-L120-Z02-F                     | ●                      | 10  | 2    | 10   | 120 | 60 | 0.3  |   |   |   |  |
| AHFM-Y00602-D10-C10-L120-Z02-H-F                   | ●                      | 10  | 2    | 10   | 120 | 60 | 0.3  |   |   |   |  |
| AHFM-Y00602-D10-C10-L120-Z02-H                     | ●                      | 10  | 2    | 10   | 120 | 60 | 0.3  |   |   |   |  |
| AHFM-Y00602-D12-C11-L120-Z02-F                     | ●                      | 12  | 2    | 11   | 120 | 15 | 0.3  |   |   |   |  |
| AHFM-Y00602-D12-C11-L120-Z02-H-F                   | ●                      | 12  | 2    | 11   | 120 | 15 | 0.3  |   |   |   |  |
| AHFM-Y00602-D12-C11-L120-Z02-H                     | ●                      | 12  | 2    | 11   | 120 | 15 | 0.3  |   |   |   |  |
| AHFM-Y00602-D12-C11-L120-Z03-F                     | ●                      | 12  | 3    | 11   | 120 | 15 | 0.3  |   |   |   |  |
| AHFM-Y00602-D12-C12-L080-Z02-F                     | ●                      | 12  | 2    | 12   | 80  | 20 | 0.3  |   |   |   |  |
| AHFM-Y00602-D12-C12-L080-Z03-F                     | ●                      | 12  | 3    | 12   | 80  | 20 | 0.3  |   |   |   |  |
| AHFM-Y00602-D12-C12-L120-Z02-F                     | ●                      | 12  | 2    | 12   | 120 | 60 | 0.3  |   |   |   |  |
| AHFM-Y00602-D12-C12-L120-Z02-H                     | ●                      | 12  | 2    | 12   | 120 | 60 | 0.3  |   |   |   |  |
| AHFM-Y00602-D12-C12-L120-Z03-F                     | ●                      | 12  | 3    | 12   | 120 | 60 | 0.3  |   |   |   |  |
| AHFM-Y00602-D12-C12-L120-Z03-H                     | ●                      | 12  | 3    | 12   | 120 | 60 | 0.3  |   |   |   |  |

DJT Ucuna Uygunudur. / Compatible with DJT Insert. / Kompatibel mit DJT Wendeplatten.

F: Eksenel ve Radyal Salgı Değeri 0,02 mm içindedir. / F: Axial and radial runout value is within 0,02mm // F: Der axiale und radiale Rundlaufwert liegt innerhalb von 0,02 mm.

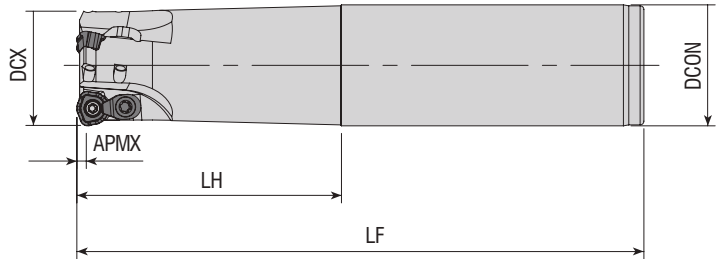

| Takım Kodu<br>Ordering Code<br>Bestell-Bezeichnung | Stok<br>Stock<br>Lager | Takım Ölçüleri (mm)<br>Dimension (mm)<br>Abmessung (mm) |      |      |     |    |      | Kesici Uç<br>Insert<br>Wendeschneidplatte | Yedek Parçaları / Spare Parts / Ersatzteile |   |   |  |
|--|------------------------|---|------|------|-----|----|------|---|---|---|---|--|
|  |                        | DCX   | ZEFP | DCON | LF  | LH | APMX |   | Sıkma Vidası<br>Screw<br>Schraube           | Baskı Parçası<br>Wedge Clamp<br>Spannpratze | Baskı Vidası<br>Clamp Screw<br>Schraube | Tork Anahtar<br>Torx Key<br>Torx-Schlüssel |
| AHFM-WD0603-D16-C16-L150-Z02                       | ●                      | 16  | 2    | 16   | 150 | 70 | 2    | WDMT 0603..                               | 3008-M2.5x6                                 | -   | -                                       | 82-T08                                     |
| AHFM-WD0603-D20-C20-L150-Z03                       | ●                      | 20  | 3    | 20   | 150 | 70 | 2    | WDMT 0603..                               | 3008-M2.5x6                                 | -   | -                                       | 82-T08                                     |
| AHFMC-WD0804-D25-C25-L150-Z02                      | ●                      | 25  | 2    | 25   | 150 | 70 | 1.5  | WDMT 0804..                               | 4010-M3X8                                   | ACK-15                                      | 4010-M3x8                               | 82-T10                                     |
| AHFMC-WD0804-D32-C32-L150-Z03                      | ●                      | 32  | 3    | 32   | 150 | 70 | 1.5  | WDMT 0804..                               | 4010-M3X8                                   | ACK-15                                      | 4010-M3x8                               | 82-T10                                     |
| AHFMC-WD1205-D32-C32-L150-Z02                      | ●                      | 32  | 2    | 32   | 150 | 70 | 3    | WDMT 1205..                               | 1415-M4x11                                  | ACK-05                                      | 4015-M4x11                              | 80-T15                                     |

R: Sağ / Right / Rechts! L: Sol / Left / Links

● Stokta / In Stock / Auf Lager ○ Stokta Yok / Non Stock Item / Kein Lagerartikel, Lieferzeit auf Anfrage

SMTM Ucuna Uygunudur. / Compatible with SMTM Insert. / Kompatibel mit SMTM Wendeplatten.

Sipariş Örneği/Ordering Example/Bestellbeispiel

1 ad./pcs./stück AHFM-Y00602-D10-C09-L120-Z02-F

Kesme Hesabı : S 377/ Cutting Calculation : P 377 / Schnittberechnung : P 377

# S-SİSTEM HIZLI İLERLEMELİ PARMAK FREZELER

S-SYSTEM HIGHFEED END MILLS

S-SYSTEM HOCHVORSCHUB- SCHAFTFRÄSER

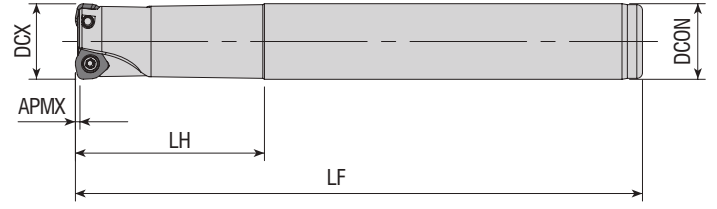

| Takım Kodu<br>Ordering Code<br>Bestell-Bezeichnung | Stok<br>Stock<br>Lager | Takım Ölçüleri (mm)<br>Dimension (mm)<br>Abmessung (mm) |      |      |     |    |      | Kesici Uç<br>Insert<br>Wendeschneidplatte | Yedek Parçaları / Spare Parts / Ersatzteile |   |   |  |
|--|------------------------|---|------|------|-----|----|------|---|---|---|---|--|
|  |                        | DCX   | ZEFP | DCON | LF  | LH | APMX |   | Sıkma Vidası<br>Screw<br>Schraube           | Baskı Parçası<br>Wedge Clamp<br>Spannpratze | Baskı Vidası<br>Clamp Screw<br>Schraube | Tork Anahtar<br>Torx Key<br>Torx-Schlüssel |
| AHFM-WD0503D-D20-C20-L150-Z02                      | ●                      | 20  | 2    | 20   | 150 | 50 | 1.25 | WD.W 0503..                               | 4010-M3x6                                   | -   | -                                       | 82-T10                                     |
| AHFM-WD0503D-D21-C20-L150-Z02                      | ●                      | 21  | 2    | 20   | 150 | 30 | 1.25 |   |   |   |   |  |
| AHFMC-WD06T3D-D26-C25-L200-Z02                     | ●                      | 26  | 2    | 25   | 200 | 30 | 1.5  | WD.W 06T3..                               | 3015-M3.5x9                                 | ACK-15                                      | 4015-M3.5x11                            | 80-T15                                     |
| AHFMC-WD06T3D-D33-C32-L200-Z03                     | ●                      | 33  | 3    | 32   | 200 | 32 | 1.5  |   |   |   |   |  |

DJT Ucuna Uygundur. / Compatible with DJT Insert. / Kompatibel mit DJT Wendeleplatten.

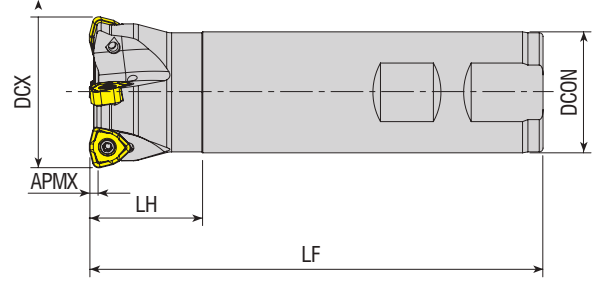

| Takım Kodu<br>Ordering Code<br>Bestell-Bezeichnung | Stok<br>Stock<br>Lager | Takım Ölçüleri (mm)<br>Dimension (mm)<br>Abmessung (mm) |      |      |     |     |      | Kesici Uç<br>Insert<br>Wendeschneidplatte | Yedek Parçaları / Spare Parts / Ersatzteile |  |
|--|------------------------|---|------|------|-----|-----|------|---|---|--|
|  |                        | DCX   | ZEFP | DCON | LF  | LH  | APMX |   | Sıkma Vidası<br>Screw<br>Schraube           | Tork Anahtar<br>Torx Key<br>Torx-Schlüssel |
| AHFM-WN0603-D16-C16-L110-Z02-H                     | ●                      | 16  | 2    | 16   | 110 | 30  | 1    | WNMX 0603..                               | 3008-M2.5x6                                 | 82-T08                                     |
| AHFM-WN0603-D16-C16-L150-Z02-H                     | ●                      | 16  | 2    | 16   | 150 | 70  | 1    |   |   |  |
| AHFM-WN0603-D17-C16-L150-Z02-H                     | ●                      | 17  | 2    | 16   | 150 | 20  | 1    |   |   |  |
| AHFM-WN0603-D20-C20-L150-Z02-H                     | ●                      | 20  | 2    | 20   | 150 | 70  | 1    |   |   |  |
| AHFM-WN0603-D20-C20-L200-Z02-H                     | ●                      | 20  | 2    | 20   | 200 | 100 | 1    |   |   |  |
| AHFM-WN0603-D21-C20-L150-Z02-H                     | ●                      | 21  | 2    | 20   | 150 | 20  | 1    |   |   |  |
| AHFM-WN09T3-D25-W25-L120-Z02-H                     | ●                      | 25  | 2    | 25   | 120 | 40  | 1.5  | WNMX 09T3..                               | 4010-M3x8                                   | 82-T10                                     |
| AHFML-WN09T3-D25-W25-L120-Z02-H                    | ●                      | 25  | 2    | 25   | 120 | 40  | 1.5  |   |   |  |
| AHFM-WN09T3-D25-C25-L200-Z02                       | ●                      | 25  | 2    | 25   | 200 | 120 | 1.5  |   |   |  |
| AHFM-WN09T3-D32-W32-L120-Z03-H                     | ●                      | 32  | 3    | 32   | 120 | 30  | 1.5  |   |   |  |
| AHFM-WN09T3-D32-W32-L200-Z03-H                     | ○                      | 32  | 3    | 32   | 200 | 100 | 1.5  |   |   |  |
| AHFM-WN09T3-D35-W32-L200-Z04-H                     | ●                      | 35  | 4    | 32   | 200 | 50  | 1.5  |   |   |  |
| AHFM-WN09T3-D40-W32-L120-Z04-H                     | ●                      | 40  | 4    | 32   | 120 | 30  | 1.5  | WNMX 1305..                               | 4015-M4x11                                  | 80-T15                                     |
| AHFM-WN09T3-D40-C32-L200-Z04                       | ●                      | 40  | 4    | 32   | 200 | 30  | 1.5  |   |   |  |
| AHFM-WN1305-D32-C32-L150-Z02-H                     | ○                      | 32  | 2    | 32   | 150 | 70  | 2    |   |   |  |
| AHFM-WN1305-D32-C32-L200-Z02-H                     | ●                      | 32  | 2    | 32   | 200 | 120 | 2    |   |   |  |
| AHFM-WN1305-D40-C32-L200-Z03-H                     | ●                      | 40  | 3    | 32   | 200 | 30  | 2    |   |   |  |

R: Sağ / Right / Rechts/ L: Sol / Left / Links

● Stokta / In Stock / Auf Lager ○ Stokta Yok / Non Stock Item / Kein Lagerartikel, Lieferzeit auf Anfrage

KRYL Ucuna Uygundur. / Compatible with KRYL Insert. / Kompatibel mit KRYL Wendeleplatten.

Sipariş Örneği/Ordering Example/Bestellbeispiel

1 ad./pcs./stück AHFM-WD0503D-D20-C20-L150-Z02

Kesme Hesabı : S 377/ Cutting Calculation : P 377 / Schnittberechnung : P 377



www.akkо.com.tr



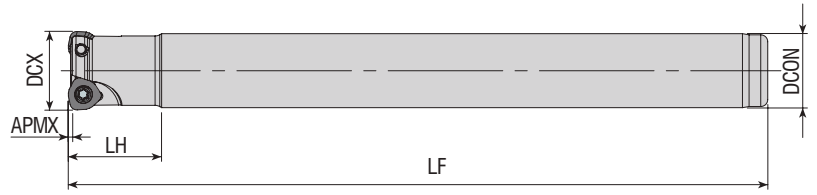

| Takım Kodu<br>Ordering Code<br>Bestell-Bezeichnung | Stok<br>Stock<br>Lager | Takım Ölçüleri (mm)<br>Dimension (mm)<br>Abmessung (mm) |      |      |     |    |      | Kesici Uç<br>Insert<br>Wendeschneidplatte | Yedek Parçaları / Spare Parts / Ersatzteile |  |  |
|--|------------------------|---|------|------|-----|----|------|---|---|--|--|
|  |                        | DCX   | ZEPF | DCON | LF  | LH | APMX |   | Sıkma Vidası<br>Screw<br>Schraube           | Tork Anahtar<br>Torx Key<br>Torx-Schlüssel |  |
| AHFM-W004T2D-D16-C16-L150-Z02                      | ●                      | 16  | 2    | 16   | 150 | 20 | 0.8  | WOMW 04T2..                               |   | 82-T08                                     |  |
| AHFM-W004T2D-D17-C16-L150-Z02                      | ●                      | 17  | 2    | 16   | 150 | 20 | 0.8  |   |   |  |  |

DJT Ucuna Uygun. / Compatible with DJT Insert. / Kompatibel mit DJT Wendeplatten.

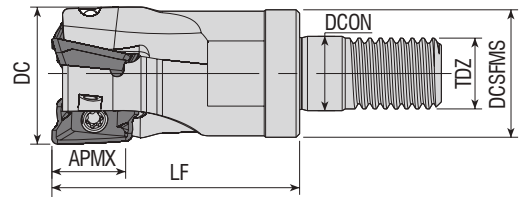

| Takım Kodu<br>Ordering Code<br>Bestell-Bezeichnung | Stok<br>Stock<br>Lager | Takım Ölçüleri (mm)<br>Dimension (mm)<br>Abmessung (mm) |   |        |     |    |      |      | Kesici Uç<br>Insert<br>Wendeschneidplatte | Yedek Parçaları / Spare Parts / Ersatzteile |  |  |
|--|------------------------|---|---|--------|-----|----|------|------|---|---|--|--|
|  |                        | DC  | Z | DCSFMS | TDZ | LF | DCON | APMX |   | Sıkma Vidası<br>Screw<br>Schraube           | Tork Anahtar<br>Torx Key<br>Torx-Schlüssel |  |
| AEM90-A01236-D16-M08-L30-Z02                       | ●                      | 16  | 2 | 14.8   | M08 | 30 | 8.5  | 10   | A0.. 1236..                               |   | 82-T08                                     |  |
| AEM90-A01236-D20-M10-L35-Z03                       | ●                      | 20  | 3 | 18     | M10 | 35 | 10.5 | 10   |   |   |  |  |

R: Sağ / Right / Rechtsl L: Sol / Left / Links

● Stokta / In Stock / Auf Lager ○ Stokta Yok / Non Stock Item / Kein Lagerartikel, Lieferzeit auf Anfrage  
MTSBH Ucuna Uygun. / Compatible with MTSBH Insert. / Kompatibel mit MTSBH Wendeplatten.

Sipariş Örneği/Ordering Example/Bestellbeispiel

1 ad./pcs./stück AHFM-W004T2D-D16-C16-L150-Z02

Kesme Hesabı : S 377 / Cutting Calculation : P 377 / Schnittberechnung : P 377

Sıkma Tork Değeri : S 376 / Tightening Torque : P 376 / Anzugsmoment : P 376

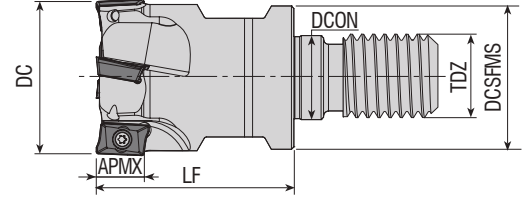

| Takım Kodu<br>Ordering Code<br>Bestell-Bezeichnung | Stok<br>Stock<br>Lager | Takım Ölçüleri (mm)<br>Dimension (mm)<br>Abmessung (mm) |     |        |     |    |      |      | Kesici Uç<br>Insert<br>Wendeschneidplatte | Yedek Parçaları / Spare Parts / Ersatzteile |  |
|--|------------------------|---|-----|--------|-----|----|------|------|---|---|--|
|  |                        | DC  | ZEP | DCSFMS | TDZ | LF | DCON | APMX |   | Sıkma Vidası<br>Screw<br>Schraube           | Tork Anahtar<br>Torx Key<br>Torx-Schlüssel |
| AEM90-AD1505D-D25-M12-L43-Z02-H                    | ●                      | 25  | 2   | 21     | M12 | 43 | 12.5 | 14.3 | ADKT 150508                               | 4015-M4x9                                   | 80-T15                                     |
| AEM90-AD1505D-D32-M16-L43-Z03-H                    | ●                      | 32  | 3   | 29     | M16 | 43 | 17   | 14.3 |   | 4015-M4x11                                  |  |

DJT Ucuna Uygun. / Compatible with DJT Insert. / Kompatibel mit DJT

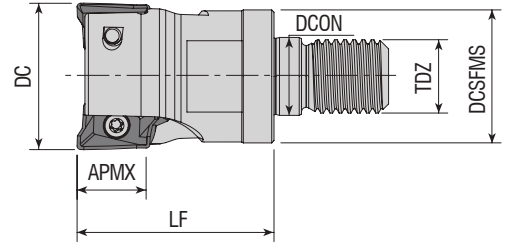

| Takım Kodu<br>Ordering Code<br>Bestell-Bezeichnung | Stok<br>Stock<br>Lager | Takım Ölçüleri (mm)<br>Dimension (mm)<br>Abmessung (mm) |     |        |     |    |      |      | Kesici Uç<br>Insert<br>Wendeschneidplatte | Yedek Parçaları / Spare Parts / Ersatzteile |  |
|--|------------------------|---|-----|--------|-----|----|------|------|---|---|--|
|  |                        | DC  | ZEP | DCSFMS | TDZ | LF | DCON | APMX |   | Sıkma Vidası<br>Screw<br>Schraube           | Tork Anahtar<br>Torx Key<br>Torx-Schlüssel |
| AEM90-AX1235-D16-M08-L30-Z02-H                     | ●                      | 16  | 2   | 14.75  | M08 | 30 | 8.5  | 10   | AX.T 1235..                               | 3108-M3x6                                   | 82-T08                                     |
| AEM90-AX1235-D20-M10-L30-Z03-H                     | ●                      | 20  | 3   | 18     | M10 | 30 | 10.5 | 10   |   | 4015-M4x9                                   |  |
| AEM90-AX1235-D25-M12-L35-Z04-H                     | ●                      | 25  | 4   | 21     | M12 | 35 | 12.5 | 10   | AX.T 1705..                               | 4015-M4x9                                   | 80-T15                                     |
| AEM90-AX1705-D25-M12-L43-Z02-H                     | ●                      | 25  | 2   | 21     | M12 | 43 | 12.5 | 14   |   |   |  |
| AEM90-AX1705-D32-M16-L43-Z02-H                     | ●                      | 32  | 2   | 29     | M16 | 43 | 17   | 14   |   |   |  |

R: Sağ / Right / Rechts/ L: Sol / Left / Links

● Stokta / In Stock / Auf Lager ○ Stokta Yok / Non Stock Item / Kein Lagerartikel, Lieferzeit auf Anfrage  
SMTM Ucuna Uygun. / Compatible with SMTM Insert. / Kompatibel mit SMTM Wendeplatten.

Sipariş Örneği/Ordering Example/Bestellbeispiel

1 ad./pcs./stück AEM90-AD1505D-D25-M12-L43-Z02-H

Kesme Hesabı : S 377/ Cutting Calculation : P 377 / Schnittberechnung : P 377  
Sıkma Tork Değeri : S 376 / Tightening Torque : P 376 / Anzugsmoment : P 376



KAPR=90°

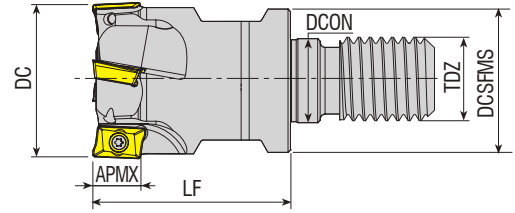

| Takım Kodu<br>Ordering Code<br>Bestell-Bezeichnung | Stok<br>Stock<br>Lager | Takım Ölçüleri (mm)<br>Dimension (mm)<br>Abmessung (mm) |      |        |     |    |      |      | Kesici Uç<br>Insert<br>Wendeschneidplatte  | Yedek Parçaları / Spare Parts / Ersatzteile |  |
|--|------------------------|---|------|--------|-----|----|------|------|--|---|--|
|  |                        | DC  | ZEFP | DCSFMS | TDZ | LF | DCON | APMX |  | Sıkma Vidası<br>Screw<br>Schraube           | Tork Anahtar<br>Torx Key<br>Torx-Schlüssel |
| AEM90-AP0903-D20-M12-L35-Z03                       | ●                      | 20  | 3    | 18     | M12 | 35 | 12.5 | 9    | APMT 0903..<br>KRYL UCUNA UYGUNDUR.<br>FOR KRYL INSERT.<br>Kompatibel mit KRYL.                | 3008-M2.5x6                                 | 82-T08                                     |
| AEM90-AP0903-D25-M12-L35-Z03                       | ●                      | 25  | 3    | 21     | M12 | 35 | 12.5 | 9    |  |   |  |
| AEM90-AP10-D16-M08-L30-Z02-H                       | ●                      | 16  | 2    | 14.75  | M08 | 30 | 8.5  | 10   | AP. 1003..<br>ISO UCUNA<br>UYGUNDUR.<br>FOR ISO INSERT.<br>Kompatibel mit ISO                  | 3008-M2.5x6                                 | 82-T08                                     |
| AEM90-AP10-D20-M10-L30-Z03-H                       | ●                      | 20  | 3    | 18     | M10 | 30 | 10.5 | 10   |  |   |  |
| AEM90-AP10-D25-M12-L35-Z03-H                       | ●                      | 25  | 3    | 21     | M12 | 35 | 12.5 | 10   |  |   |  |
| AEM90-AP10-D32-M16-L35-Z04-H                       | ●                      | 32  | 4    | 29     | M16 | 35 | 17   | 10   |  |   |  |
| AEM90-AP10-D32-M16-L40-Z04-H                       | ●                      | 32  | 4    | 29     | M16 | 40 | 17   | 10   |  |   |  |
| AEM90-AP10-D40-M16-L43-Z05-H                       | ●                      | 40  | 5    | 29     | M16 | 43 | 17   | 10   |  |   |  |
| AEM90-AP10-D42-M16-L43-Z05-H                       | ●                      | 42  | 5    | 29     | M16 | 43 | 17   | 10   |  |   |  |
| AEM90-AP10D-D16-M08-L30-Z02-H                      | ●                      | 16  | 2    | 14.75  | M08 | 30 | 8.5  | 10   |  |   |  |
| AEM90-AP10D-D20-M10-L30-Z03-H                      | ●                      | 20  | 3    | 18     | M10 | 30 | 10.5 | 10   |  |   |  |
| AEM90-AP10D-D25-M12-L35-Z03-H                      | ●                      | 25  | 3    | 21     | M12 | 35 | 12.5 | 10   |  |   |  |
| AEM90-AP11-D16-M08-L30-Z02-H                       | ●                      | 16  | 2    | 14.75  | M08 | 30 | 8.5  | 11   | AP. 11T3..<br>ZCC UCUNA<br>UYGUNDUR.<br>FOR ZCC INSERT.<br>Kompatibel mit ZCC<br>Wendeplatten. | 3008-M2.5x6                                 | 82-T08                                     |
| AEM90-AP11-D20-M10-L30-Z03-H                       | ●                      | 20  | 3    | 18     | M10 | 30 | 10.5 | 11   |  |   |  |
| AEM90-AP11-D25-M12-L35-Z03-H                       | ●                      | 25  | 3    | 21     | M12 | 35 | 12.5 | 11   |  |   |  |
| AEM90-AP11-D32-M16-L35-Z04-H                       | ●                      | 32  | 4    | 29     | M16 | 35 | 17   | 11   |  |   |  |
| AEM90-AP11-D40-M16-L43-Z05-H                       | ●                      | 40  | 5    | 29     | M16 | 43 | 17   | 11   |  |   |  |
| AEM90-AP16-D25-M12-L43-Z02-H                       | ●                      | 25  | 2    | 21     | M12 | 43 | 12.5 | 16   | AP. 1604..<br>ISO UCUNA<br>UYGUNDUR.<br>FOR ISO INSERT.<br>Kompatibel mit ISO                  | 4015-M4x9                                   | 80-T15                                     |
| AEM90-AP16-D32-M16-L43-Z03-H                       | ●                      | 32  | 3    | 29     | M16 | 43 | 17   | 16   |  |   |  |
| AEM90-AP16-D40-M16-L43-Z04-H                       | ●                      | 40  | 4    | 29     | M16 | 43 | 17   | 16   |  |   |  |
| AEM90-AP16-D42-M16-L43-Z04-H                       | ●                      | 42  | 4    | 29     | M16 | 43 | 17   | 16   |  |   |  |
| AEM90-AP16DJ-D25-M12-L43-Z02-H                     | ●                      | 25  | 2    | 21     | M12 | 43 | 12.5 | 16   | AP. 1604..<br>DJT UCUNA UYGUNDUR.<br>FOR DJT INSERT.<br>Kompatibel mit DJT                     | 4015-M4x9                                   | 80-T15                                     |
| AEM90-AP16DJ-D32-M16-L43-Z03-H                     | ●                      | 32  | 3    | 29     | M16 | 43 | 17   | 16   |  |   |  |
| AEM90-AP16DJ-D40-M16-L43-Z04-H                     | ●                      | 40  | 4    | 29     | M16 | 43 | 17   | 16   |  |   |  |
| AEM90-AP16L-D25-M12-L43-Z02-H                      | ●                      | 25  | 2    | 21     | M12 | 43 | 12.5 | 16   | AP. 1604..<br>LMN UCUNA UYGUNDUR.<br>FOR LMN INSERT.<br>Kompatibel mit LMN                     | 4015-M4x9                                   | 80-T15                                     |
| AEM90-AP16L-D32-M16-L43-Z03-H                      | ●                      | 32  | 3    | 29     | M16 | 43 | 17   | 16   |  |   |  |
| AEM90-AP16L-D40-M16-L43-Z04-H                      | ●                      | 40  | 4    | 29     | M16 | 43 | 17   | 16   |  |   |  |

R: Sağ / Right / Rechtsl L: Sol / Left / Links

● Stokta / In Stock / Auf Lager ○ Stokta Yok / Non Stock Item / Kein Lagerartikel, Lieferzeit auf Anfrage

Sipariş Örneği/Ordering Example/Bestellbeispiel

1 ad./pcs./stück AEM90-AP0903-D20-M12-L35-Z03

Kesme Hesabı : S 377/ Cutting Calculation : P 377 / Schnittberechnung : P 377

Sıkma Tork Değeri : S 376 / Tightening Torque : P 376 / Anzugsmoment : P 376

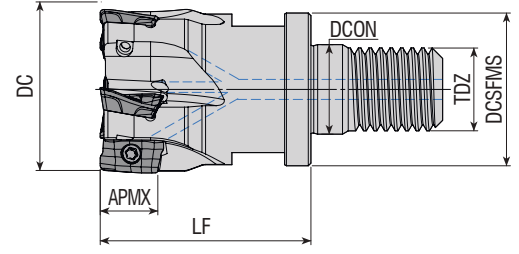

| Takım Kodu<br>Ordering Code<br>Bestell-Bezeichnung | Stok<br>Stock<br>Lager | Takım Ölçüleri (mm)<br>Dimension (mm)<br>Abmessung (mm) |      |        |     |    |      |      | Kesici Uç<br>Insert<br>Wendeschneidplatte | Yedek Parçaları / Spare Parts / Ersatzteile |  |
|--|------------------------|---|------|--------|-----|----|------|------|---|---|--|
|  |                        | DC  | ZEFP | DCSFMS | TDZ | LF | DCON | APMX |   | Sıkma Vidası<br>Screw<br>Schraube           | Tork Anahtar<br>Torx Key<br>Torx-Schlüssel |
| AEM90-BD11T3-D16-M08-L25-Z02-H                     | ●                      | 16  | 2    | 14.75  | M08 | 25 | 8.5  | 10   |   |   |  |
| AEM90-BD11T3-D25-M12-L35-Z04-H                     | ●                      | 25  | 4    | 21     | M12 | 35 | 12.5 | 10   |   |   |  |
| AEM90-BD11T3-D32-M16-L40-Z05-H                     | ●                      | 32  | 5    | 29     | M16 | 40 | 17   | 10   |   |   |  |

KYCR Ucuna Uygun. / Compatible with KYCR Insert. / Kompatibel mit KYCR Wendeplatten.

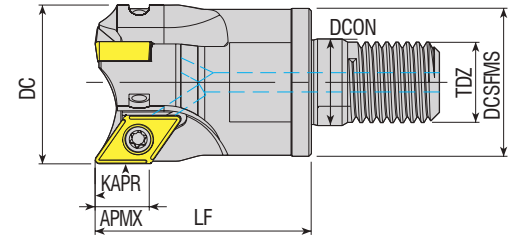

| Takım Kodu<br>Ordering Code<br>Bestell-Bezeichnung | Stok<br>Stock<br>Lager | Takım Ölçüleri (mm)<br>Dimension (mm)<br>Abmessung (mm) |      |        |     |    |      |      | Kesici Uç<br>Insert<br>Wendeschneidplatte | Yedek Parçaları / Spare Parts / Ersatzteile |  |
|--|------------------------|---|------|--------|-----|----|------|------|---|---|--|
|  |                        | DC  | ZEFP | DCSFMS | TDZ | LF | DCON | APMX |   | Sıkma Vidası<br>Screw<br>Schraube           | Tork Anahtar<br>Torx Key<br>Torx-Schlüssel |
| AEM90-DC07-D20-M10-L30-Z02-H                       | ●                      | 20  | 2    | 18     | M10 | 30 | 10.5 | 7    |   |   |  |
| AEM90-DC07-D25-M12-L35-Z03-H                       | ●                      | 25  | 3    | 21     | M12 | 35 | 12.5 | 7    |   |   |  |
| AEM90-DC07-D32-M16-L43-Z04-H                       | ●                      | 32  | 4    | 29     | M16 | 43 | 17   | 7    |   |   |  |
| AEM90-DC07-D40-M16-L43-Z05-H                       | ●                      | 40  | 5    | 29     | M16 | 43 | 17   | 7    |   |   |  |
| AEM90-DC11-D32-M16-L43-Z03-H-F                     | ●                      | 32  | 3    | 29     | M16 | 43 | 17   | 11   |   |   |  |
| AEM90-DC11-D40-M16-L43-Z03-H-F                     | ●                      | 40  | 3    | 29     | M16 | 43 | 17   | 11   |   |   |  |

R: Sağ / Right / Rechts L: Sol / Left / Links

● Stokta / In Stock / Auf Lager ○ Stokta Yok / Non Stock Item / Kein Lagerartikel, Lieferzeit auf Anfrage

ISO Ucuna Uygun. / Compatible with ISO Insert. / Kompatibel mit ISO Wendeplatten.

F: Eksenel ve Radyal Salgı Değeri 0,02 mm içindedir. / F: Axial and Radial Runout Value is within 0,02 mm. / F: Der axiale und radiale Rundlaufwert liegt innerhalb von 0,02 mm.

Sipariş Örneği/Ordering Example/Bestellbeispiel

1 ad./pcs./stück AEM90-BD11T3-D16-M08-L25-Z02-H

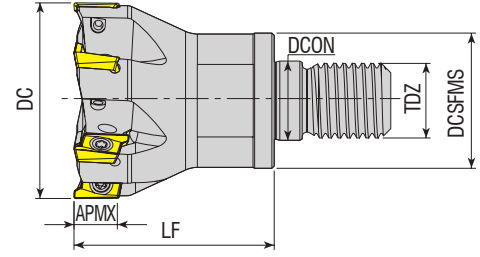

| Takım Kodu<br>Ordering Code<br>Bestell-Bezeichnung | Stok<br>Stock<br>Lager | Takım Ölçüleri (mm)<br>Dimension (mm)<br>Abmessung (mm) |      |        |     |    |      |      | Kesici Uç<br>Insert<br>Wendeschneidplatte | Yedek Parçaları / Spare Parts / Ersatzteile |  |
|--|------------------------|---|------|--------|-----|----|------|------|---|---|--|
|  |                        | DC  | ZEFP | DCSFMS | TDZ | LF | DCON | APMX |   | Sıkma Vidası<br>Screw<br>Schraube           | Tork Anahtar<br>Torx Key<br>Torx-Schlüssel |
| AEM90-RT10-D16-M08-L20-Z02-H                       | ●                      | 16  | 2    | 14.75  | M08 | 20 | 8.5  | 10   |   |   |  |
| AEM90-RT10-D20-M10-L25-Z03-H                       | ●                      | 20  | 3    | 18     | M10 | 25 | 10.5 | 10   |   |   |  |
| AEM90-RT10-D25-M12-L30-Z04-H                       | ●                      | 25  | 4    | 21     | M12 | 30 | 12.5 | 10   |   |   |  |
| AEM90-RT10-D32-M16-L43-Z05-H                       | ●                      | 32  | 5    | 29     | M16 | 43 | 17   | 10   |   |   |  |
| AEM90-RT10-D42-M16-L43-Z06-H                       | ●                      | 42  | 6    | 29     | M16 | 43 | 17   | 10   |   |   |  |

SFTY Ucuna Uygundur. / Compatible with SFTY Insert. / Kompatibel mit SFTY Wendeplatten.

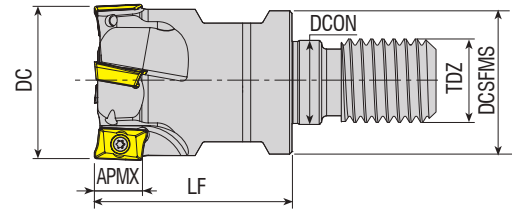

| Takım Kodu<br>Ordering Code<br>Bestell-Bezeichnung | Stok<br>Stock<br>Lager | Takım Ölçüleri (mm)<br>Dimension (mm)<br>Abmessung (mm) |      |        |     |    |      |      | Kesici Uç<br>Insert<br>Wendeschneidplatte | Yedek Parçaları / Spare Parts / Ersatzteile |  |
|--|------------------------|---|------|--------|-----|----|------|------|---|---|--|
|  |                        | DC  | ZEFP | DCSFMS | TDZ | LF | DCON | APMX |   | Sıkma Vidası<br>Screw<br>Schraube           | Tork Anahtar<br>Torx Key<br>Torx-Schlüssel |
| AEM90-R390.11-D16-M08-L30-Z02-H                    | ●                      | 16  | 2    | 14.75  | M08 | 30 | 8.5  | 10   |   | 3008-M2.5x5                                 |  |
| AEM90-R390.11-D20-M10-L30-Z03-H                    | ●                      | 20  | 3    | 18     | M10 | 30 | 10.5 | 10   |   |   |  |
| AEM90-R390.11-D25-M12-L35-Z03-H                    | ●                      | 25  | 3    | 21     | M12 | 35 | 12.5 | 10   |   |   |  |
| AEM90-R390.11-D32-M16-L43-Z04-H                    | ●                      | 32  | 4    | 29     | M16 | 43 | 17   | 10   |   |   |  |
|  |                        |   |      |        |     |    |      |      |   | R390-11T3..                                 |  |

R: Sağ / Right / Rechts/ L: Sol / Left / Links

● Stokta / In Stock / Auf Lager ○ Stokta Yok / Non Stock Item / Kein Lagerartikel, Lieferzeit auf Anfrage  
SNDVK Ucuna Uygundur. / Compatible with SNDVK Insert. / Kompatibel mit SNDVK Wendeplatten.

Sipariş Örneği/Ordering Example/Bestellbeispiel  
1 ad./pcs./stück AEM90-RT10-D16-M08-L20-Z02-H

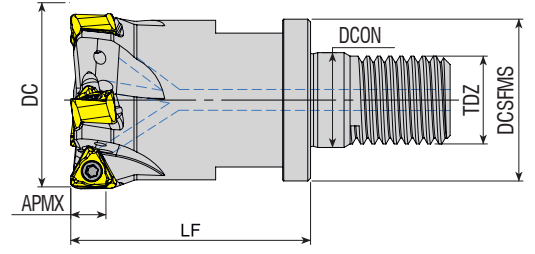

| Takım Kodu<br>Ordering Code<br>Bestell-Bezeichnung | Stok<br>Stock<br>Lager | Takım Ölçüleri (mm)<br>Dimension (mm)<br>Abmessung (mm) |      |        |     |    |      |      | Kesici Uç<br>Insert<br>Wendeschneidplatte | Yedek Parçaları / Spare Parts / Ersatzteile |  |
|--|------------------------|---|------|--------|-----|----|------|------|---|---|--|
|  |                        | DC  | ZEFP | DCSFMS | TDZ | LF | DCON | APMX |   | Sıkma Vidası<br>Screw<br>Schraube           | Tork Anahtar<br>Torx Key<br>Torx-Schlüssel |
| • new • AEM90-TNG10-D20-M10-L26-Z02-H              | ●                      | 20  | 2    | 18     | M10 | 26 | 10.5 | 5    |   |   |  |
| • new • AEM90-TNG10-D20-M10-L26-Z03-H              | ●                      | 20  | 3    | 18     | M10 | 26 | 10.5 | 5    |   |   |  |
| AEM90-TNG10-D21-M10-L25-Z03-H                      | ●                      | 21  | 3    | 18     | M10 | 25 | 10.5 | 5    |   |   |  |
| • new • AEM90-TNG10-D25-M12-L33-Z03-H              | ●                      | 25  | 3    | 21     | M12 | 33 | 12.5 | 5    |   |   |  |
| • new • AEM90-TNG10-D25-M12-L33-Z04-H              | ●                      | 25  | 4    | 21     | M12 | 33 | 12.5 | 5    |   |   |  |
| AEM90-TNG10-D26-M12-L30-Z04-H                      | ●                      | 26  | 4    | 21     | M12 | 30 | 12.5 | 5    |   |   |  |
| • new • AEM90-TNG10-D32-M16-L43-Z04-H              | ●                      | 32  | 4    | 29     | M16 | 43 | 17   | 5    |   |   |  |
| • new • AEM90-TNG10-D32-M16-L43-Z05-H              | ●                      | 32  | 5    | 29     | M16 | 43 | 17   | 5    |   |   |  |
| AEM90-TNG10-D33-M16-L43-Z05-H                      | ●                      | 33  | 5    | 29     | M16 | 43 | 17   | 5    |   |   |  |
| AEM90-TNG10-D35-M16-L43-Z05-H                      | ●                      | 35  | 5    | 29     | M16 | 43 | 17   | 5    |   |   |  |

PRMT Ucuna Uygun. / Compatible with PRMT Insert. / Kompatibel mit PRMT Wendeplatten.

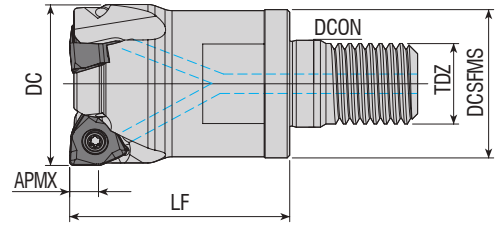

| Takım Kodu<br>Ordering Code<br>Bestell-Bezeichnung | Stok<br>Stock<br>Lager | Takım Ölçüleri (mm)<br>Dimension (mm)<br>Abmessung (mm) |      |        |     |    |      |      | Kesici Uç<br>Insert<br>Wendeschneidplatte | Yedek Parçaları / Spare Parts / Ersatzteile |  |
|--|------------------------|---|------|--------|-----|----|------|------|---|---|--|
|  |                        | DC  | ZEFP | DCSFMS | TDZ | LF | DCON | APMX |   | Sıkma Vidası<br>Screw<br>Schraube           | Tork Anahtar<br>Torx Key<br>Torx-Schlüssel |
| AEM90-WN0604Z-D25-M12-L35-Z02-H                    | ●                      | 25  | 2    | 21     | M12 | 35 | 12.5 | 5.7  |   |   |  |
| AEM90-WN0604Z-D32-M16-L43-Z03-H                    | ●                      | 32  | 3    | 29     | M16 | 43 | 17   | 5.7  |   |   |  |
| AEM90-WN0604Z-D40-M16-L43-Z04-H                    | ●                      | 40  | 4    | 29     | M16 | 43 | 17   | 5.7  |   |   |  |

R: Sağ / Right / Rechts/ L: Sol / Left / Links

● Stokta / In Stock / Auf Lager ○ Stokta Yok / Non Stock Item / Kein Lagerartikel, Lieferzeit auf Anfrage  
ZCC Ucuna Uygun. / Compatible with ZCC Insert. / Kompatibel mit ZCC Wendeplatten.



Sipariş Örneği/Ordering Example/Bestellbeispiel

1 ad./pcs./stück AEM90-TNG10-D20-M10-L26-Z02-H

Kesme Hesabı : S 377/ Cutting Calculation : P 377 / Schnittberechnung : P 377

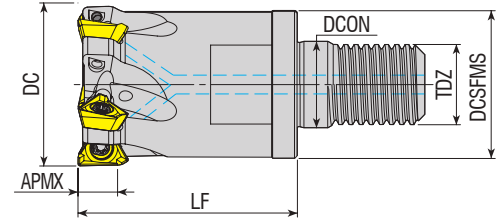

Sıkma Tork Değeri : S 376 / Tightening Torque : P 376 / Anzugsmoment : P 376

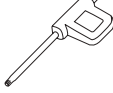

| Takım Kodu<br>Ordering Code<br>Bestell-Bezeichnung | Stok<br>Stock<br>Lager | Takım Ölçüleri (mm)<br>Dimension (mm)<br>Abmessung (mm) |      |        |     |    |      |      | Kesici Uç<br>Insert<br>Wendeschneidplatte   | Yedek Parçaları / Spare Parts / Ersatzteile   |   |
|--|------------------------|---|------|--------|-----|----|------|------|---|---|---|
|  |                        | DC  | ZEFP | DCSFMS | TDZ | LF | DCON | APMX |   | Sıkma Vidası<br>Screw<br>Schraube   | Tork Anahtar<br>Torx Key<br>Torx-Schlüssel  |
| AEM90-3P1004-D20-M10-L35-Z02                       | ●                      | 20  | 2    | 18     | 10  | 35 | 10.5 | 7    |  |  |  |
| AEM90-3P1004-D32-M16-L43-Z05-H                     | ●                      | 32  | 5    | 29     | 16  | 43 | 17   | 7    |   |   |   |

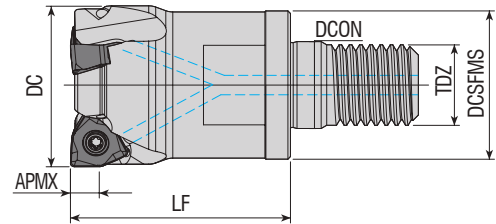
TGTC Ucuna Uygunur. / Compatible with TGTC Insert. / Kompatibel mit TGTC Wendepplatten.

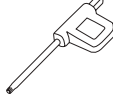

| Takım Kodu<br>Ordering Code<br>Bestell-Bezeichnung | Stok<br>Stock<br>Lager | Takım Ölçüleri (mm)<br>Dimension (mm)<br>Abmessung (mm) |      |        |     |    |      |      | Kesici Uç<br>Insert<br>Wendeschneidplatte   | Yedek Parçaları / Spare Parts / Ersatzteile   |   |
|--|------------------------|---|------|--------|-----|----|------|------|---|---|---|
|  |                        | DC  | ZEFP | DCSFMS | TDZ | LF | DCON | APMX |   | Sıkma Vidası<br>Screw<br>Schraube   | Tork Anahtar<br>Torx Key<br>Torx-Schlüssel  |
| AEM90-XN0403-D32-M16-L43-Z05-H                     | ●                      | 32  | 5    | 29     | M16 | 43 | 17   | 4    |  |  |  |
| AEM90-XN0403-D42-M16-L43-Z06-H                     | ●                      | 42  | 6    | 29     | M16 | 43 | 17   | 4    |   |   |   |

R: Sağ / Right / Rechtsl L: Sol / Left / Links

● Stokta / In Stock / Auf Lager ○ Stokta Yok / Non Stock Item / Kein Lagerartikel, Lieferzeit auf Anfrage

SC Ucuna Uygunur. / Compatible with SC Insert. / Kompatibel mit SC Wendepplatten.

Sipariş Örneği/Ordering Example/Образец заказа  
1 ad./pcs./шт. AEM90-3P1004-D20-M10-L35-Z02  
Kesme Hesabı : S 377 / Cutting Calculation : P 377 / Schnittberechnung : P 377

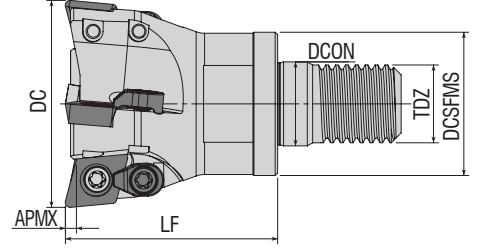

| Takım Kodu<br>Ordering Code<br>Bestell-Bezeichnung | Stok<br>Stock<br>Lager | Takım Ölçüleri (mm)<br>Dimension (mm)<br>Abmessung (mm) |      |        |     |    |      |      | Kesici Uç<br>Insert<br>Wendeschneidplatte | Yedek Parçaları / Spare Parts / Ersatzteile |   |   |  |        |
|--|------------------------|---|------|--------|-----|----|------|------|---|---|---|---|--|--------|
|  |                        | DC  | ZEFP | DCSFMS | TDZ | LF | DCON | APMX |   | Sıkma Vidası<br>Screw<br>Schraube           | Baskı Parçası<br>Wedge Clamp<br>Spannpratze | Baskı Vidası<br>Clamp Screw<br>Schraube | Tork Anahtar<br>Torx Key<br>Torx-Schlüssel |        |
| AEM95-XD0206-D16-M08-L23-Z02-H                     | ●                      | 16  | 2    | 14.75  | M08 | 23 | 8.5  | 1    | XDHW 0206..                               |   |   | -                                       | -  | 82-T08 |
| AEM95-XD0206-D16-M08-L23-Z02-H-F                   | ●                      | 16  | 2    | 14.75  | M08 | 23 | 8.5  | 1    |   |   |   |   |  |        |
| AEM95-XD0206-D20-M10-L30-Z03-H                     | ●                      | 20  | 3    | 18     | M10 | 30 | 10.5 | 1    |   |   |   |   |  |        |
| AEM95-XD0206-D20-M10-L30-Z03-H-F                   | ●                      | 20  | 3    | 18     | M10 | 30 | 10.5 | 1    |   |   |   |   |  |        |
| AEM95-XD0206-D25-M12-L35-Z03-H                     | ●                      | 25  | 3    | 21     | M12 | 35 | 12.5 | 1    |   |   |   |   |  |        |
| AEM95-XD0206-D25-M12-L35-Z03-H-F                   | ●                      | 25  | 3    | 21     | M12 | 35 | 12.5 | 1    |   |   |   |   |  |        |
| AEM95C-XD0310-D35-M16-L43-Z03-H                    | ●                      | 35  | 3    | 29     | M16 | 43 | 17   | 1.5  | XDHW 0310..                               |   |   | ACK-15                                  | 4015-M3.5x11                               | 80-T15 |
| AEM95C-XD0310-D35-M16-L43-Z03-H-F                  | ●                      | 35  | 3    | 29     | M16 | 43 | 17   | 1.5  |   |   |   |   |  |        |
| AEM95C-XD0310-D42-M16-L43-Z04-H                    | ●                      | 42  | 4    | 29     | M16 | 43 | 17   | 1.5  |   |   |   |   |  |        |
| AEM95C-XD0310-D42-M16-L43-Z04-H-F                  | ●                      | 42  | 4    | 29     | M16 | 43 | 17   | 1.5  |   |   |   |   |  |        |

DJT Ucuna Uygun. / Compatible with DJT Insert. / Kompatibel mit DJT Wendeplatten.

Çap Ölçüsü - 0,02 mm Olarak üretiliyor. F: ± 0,02 mm Demektir. Ör: Ø16 Takım 15,98 ± 0,02 mm yani 16,00 mm - 15,96 mm Olmalıdır.

Diameter Size is produced as - 0.02 mm. F: means ± 0,02 mm. For example: Ø16 tool 15,98 ± 0,02 mm, it means that it should be 16,00 mm - 15,96 mm.

Durchmesser - Es wird mit -0,02 mm hergestellt. Das heißt F: ± 0,02 mm. Zum Beispiel: Der Ø16-Satz sollte 15,98 ± 0,02 mm, 16,00 mm - 15,96 mm betragen.

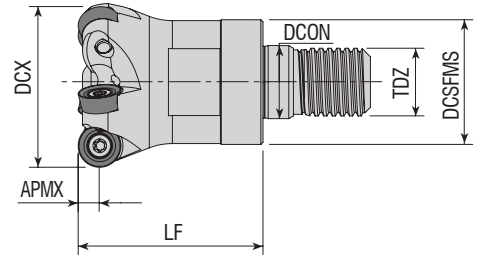

| Takım Kodu<br>Ordering Code<br>Bestell-Bezeichnung | Stok<br>Stock<br>Lager | Takım Ölçüleri (mm)<br>Dimension (mm)<br>Abmessung (mm) |      |        |     |    |      |      | Kesici Uç<br>Insert<br>Wendeschneidplatte | Yedek Parçaları / Spare Parts / Ersatzteile |  |           |        |
|--|------------------------|---|------|--------|-----|----|------|------|---|---|--|-----------|--------|
|  |                        | DCX   | ZEFP | DCSFMS | TDZ | LF | DCON | APMX |   | Sıkma Vidası<br>Screw<br>Schraube           | Tork Anahtar<br>Torx Key<br>Torx-Schlüssel |           |        |
| AEMR-RC10T3-D25-M12-L35-Z03-H                      | ●                      | 25  | 3    | 21     | M12 | 35 | 12.5 | 5    | RC.. 10T3..                               |   |  | 4015-M4x9 | 80-T15 |
| AEMR-RC10T3-D32-M16-L43-Z04-H                      | ●                      | 32  | 4    | 29     | M16 | 43 | 17   | 5    |   |   |  |           |        |
| AEMR-RC10T3-D40-M16-L43-Z05-H                      | ●                      | 40  | 5    | 29     | M16 | 43 | 17   | 5    |   |   |  |           |        |

ZCC Ucuna Uygun. / Compatible with ZCC Insert. / Kompatibel mit ZCC Wendeplatten.

Sipariş Örneği/Ordering Example/Bestellbeispiel

1 ad./pcs./stück AEM95-XD0206-D16-M08-L23-Z02-H

Kesme Hesabı : S 367 / Cutting Calculation : P 367 / Schnittberechnung : P 367

Sıkma Tork Değeri : S 376 / Tightening Torque : P 376 / Anzugsmoment : P 376



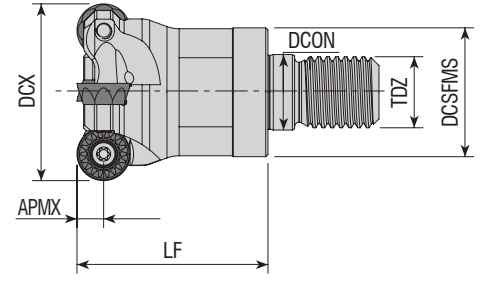

| Takım Kodu<br>Ordering Code<br>Bestell-Bezeichnung | Stok<br>Stock<br>Lager | Takım Ölçüleri (mm)<br>Dimension (mm)<br>Abmessung (mm) |      |        |     |    |      |      | Kesici Uç<br>Insert<br>Wendeschneidplatte | Yedek Parçaları / Spare Parts / Ersatzteile |  |
|--|------------------------|---|------|--------|-----|----|------|------|---|---|--|
|  |                        | DCX   | ZEFP | DCSFMS | TDZ | LF | DCON | APMX |   | Sıkma Vidası<br>Screw<br>Schraube           | Tork Anahtar<br>Torx Key<br>Torx-Schlüssel |
| AEMR-RP08T2M-D20-M10-L30-Z02-H                     | ●                      | 20  | 2    | 18     | M10 | 30 | 10.5 | 4    |   | 3008-M2.5x6                                 | 82-T08                                     |
| AEMR-RP10T3M-D25-M12-L35-Z02-H                     | ●                      | 25  | 2    | 21     | M12 | 35 | 12.5 | 5    |   | 4015-M3.5x9                                 | 80-T15                                     |
| AEMR-RP10T3M-D32-M16-L43-Z03-H                     | ●                      | 32  | 3    | 29     | M16 | 43 | 17   | 5    |   | 4015-M3.5x9                                 |  |
| AEMR-RP1204M-D32-M16-L43-Z03-H                     | ●                      | 32  | 3    | 29     | M16 | 43 | 17   | 6    |   | 4015-M4x9                                   |  |
| AEMR-RP1204M-D40-M16-L43-Z04-H                     | ●                      | 40  | 4    | 29     | M16 | 43 | 17   | 6    |   | 4015-M4x9                                   |  |

MTSBH Ucuna Uygundur. / Compatible with MTSBH Insert. / Kompatibel mit MTSBH Wendeplatten.

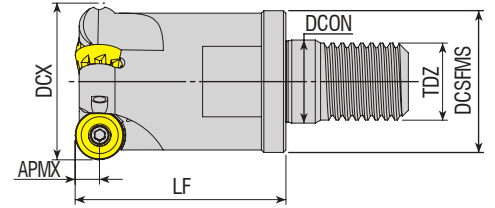

| Takım Kodu<br>Ordering Code<br>Bestell-Bezeichnung | Stok<br>Stock<br>Lager | Takım Ölçüleri (mm)<br>Dimension (mm)<br>Abmessung (mm) |      |        |     |    |      |      | Kesici Uç<br>Insert<br>Wendeschneidplatte | Yedek Parçaları / Spare Parts / Ersatzteile |  |
|--|------------------------|---|------|--------|-----|----|------|------|---|---|--|
|  |                        | DCX   | ZEFP | DCSFMS | TDZ | LF | DCON | APMX |   | Sıkma Vidası<br>Screw<br>Schraube           | Tork Anahtar<br>Torx Key<br>Torx-Schlüssel |
| AEMR-RP10T3-D25-M12-L35-Z02-H                      | ●                      | 25  | 2    | 21     | M12 | 35 | 12.5 | 5    |   | 4010-M3x8                                   | 82-T10                                     |
| AEMR-RP10T3-D32-M16-L43-Z03-H                      | ●                      | 32  | 3    | 29     | M16 | 43 | 17   | 5    |   | 4010-M3x8                                   | 82-T10                                     |
| AEMR-RP1204-D32-M16-L43-Z03-H                      | ●                      | 32  | 3    | 29     | M16 | 43 | 17   | 6    |   | 4015-M4x9                                   | 80-T15                                     |

R: Sağ / Right / Rechts / L: Sol / Left / Links

● Stokta / In Stock / Auf Lager ○ Stokta Yok / Non Stock Item / Kein Lagerartikel, Lieferzeit auf Anfrage  
CRTZT Ucuna Uygundur. / Compatible with CRTZT Insert. / Kompatibel mit CRTZT Wendeplatten.

Sipariş Örneği/Ordering Example/Bestellbeispiel

1 ad./pcs./stück AEMR-RP08T2M-D20-M10-L30-Z02-H

Kesme Hesabı : S 367 / Cutting Calculation : P 367 / Schnittberechnung : P 367

Sıkma Tork Değeri : S 367 / Tightening Torque : P 367 / Anzugsmoment : P 367

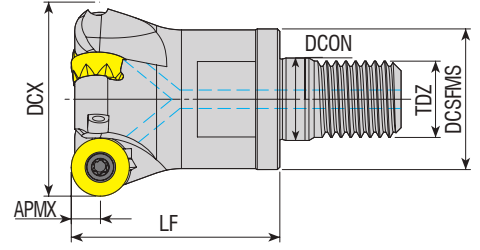

| Takım Kodu<br>Ordering Code<br>Bestell-Bezeichnung | Stok<br>Stock<br>Lager | Takım Ölçüleri (mm)<br>Dimension (mm)<br>Abmessung (mm) |      |        |     |    |      |      | Kesici Uç<br>Insert<br>Wendeschneidplatte | Yedek Parçaları / Spare Parts / Ersatzteile |   |   |
|--|------------------------|---|------|--------|-----|----|------|------|---|---|---|---|
|  |                        | DCX   | ZEFP | DCSFMS | TDZ | LF | DCON | APMX |   | Sıkma Vidası<br>Screw<br>Schraube           | Baskı Parçası<br>Wedge Clamp<br>Spannpratze | Baskı Vidası<br>Clamp Screw<br>Schraube |
| <b>new</b> AEMR-RY10-D25-M12-L43-Z03-H             | ●                      | 25  | 3    | 21     | M12 | 43 | 12.5 | 5    | RYMX 1004..                               | 4015-M3.5x9                                 | 80-T15                                      |   |
| AEMR-RY10-D32-M16-L43-Z04-H                        | ●                      | 32  | 4    | 29     | M16 | 43 | 17   | 5    |   |   |   |   |
| AEMR-RY10-D40-M16-L43-Z05-H                        | ●                      | 40  | 5    | 29     | M16 | 43 | 17   | 5    |   |   |   |   |
| AEMR-RY12-D32-M16-L43-Z03-H                        | ●                      | 32  | 3    | 29     | M16 | 43 | 17   | 6    | RYMX 1205..                               | 4015-M4x9                                   | 80-T15                                      |   |
| AEMR-RY12-D40-M16-L43-Z03-H                        | ●                      | 40  | 3    | 29     | M16 | 43 | 17   | 6    |   |   |   |   |

TGTC Ucuna Uygun. / Compatible with TGTC Insert. / Kompatibel mit TGTC Wendeplatten.

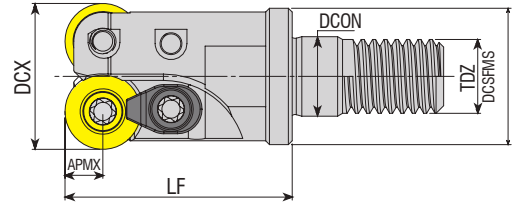

| Takım Kodu<br>Ordering Code<br>Bestell-Bezeichnung | Stok<br>Stock<br>Lager | Takım Ölçüleri (mm)<br>Dimension (mm)<br>Abmessung (mm) |      |        |     |    |      |      | Kesici Uç<br>Insert<br>Wendeschneidplatte | Yedek Parçaları / Spare Parts / Ersatzteile |   |   |  |
|--|------------------------|---|------|--------|-----|----|------|------|---|---|---|---|--|
|  |                        | DCX   | ZEFP | DCSFMS | TDZ | LF | DCON | APMX |   | Sıkma Vidası<br>Screw<br>Schraube           | Baskı Parçası<br>Wedge Clamp<br>Spannpratze | Baskı Vidası<br>Clamp Screw<br>Schraube | Tork Anahtar<br>Torx Key<br>Torx-Schlüssel |
| AEMRC-RD10T3-D20-M10-L30-Z02                       | ●                      | 20  | 2    | 18     | M10 | 30 | 10.5 | 5    | RD.. 10T3                                 | 4015-M3.5x9                                 | ACK-15                                      | 4015-M3.5x11                            | 80-T15                                     |
| AEMRC-RD10T3-D32-M16-L43-Z03-H                     | ●                      | 32  | 3    | 29     | M16 | 43 | 17   | 5    |   |   |   |   |  |

R: Sağ / Right / Rechts L: Sol / Left / Links

● Stokta / In Stock / Auf Lager ○ Stokta Yok / Non Stock Item / Kein Lagerartikel, Lieferzeit auf Anfrage  
ISO Ucuna Uygun. / Compatible with ISO Insert. / Kompatibel mit ISO Wendeplatten.

Sipariş Örneği/Ordering Example/Bestellbeispiel

1 ad./pcs./stück AEMR-RY10-D25-M12-L43-Z03-H

Kesme Hesabı : S 377/ Cutting Calculation : P 377 / Schnittberechnung : P 377

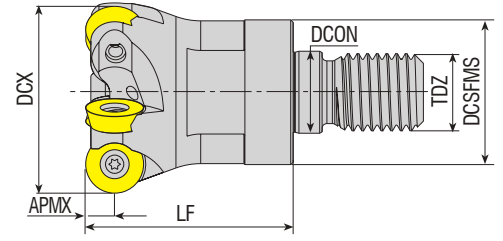

| Takım Kodu<br>Ordering Code<br>Bestell-Bezeichnung | Stok<br>Stock<br>Lager | Takım Ölçüleri (mm)<br>Dimension (mm)<br>Abmessung (mm) |      |        |     |    |      |      | Kesici Uç<br>Insert<br>Wendeschneidplatte | Yedek Parçaları / Spare Parts / Ersatzteile |  |           |
|--|------------------------|---|------|--------|-----|----|------|------|---|---|--|-----------|
|  |                        | DCX   | ZEFP | DCSFMS | TDZ | LF | DCON | APMX |   | Sıkma Vidası<br>Screw<br>Schraube           | Tork Anahtar<br>Torx Key<br>Torx-Schlüssel |           |
| AEMR-RD0702-D15-M08-L23-Z02-H                      | ●                      | 15  | 2    | 13     | M08 | 23 | 8.5  | 3.5  | RD.. 0702                                 | 3008-M2.5x6                                 | 82-T08                                     |           |
| AEMR-RD0702-D16-M08-L23-Z02-H                      | ●                      | 16  | 2    | 14.75  | M08 | 23 | 8.5  | 3.5  |   |   |  |           |
| AEMR-RD0702-D20-M10-L30-Z04-H                      | ●                      | 20  | 4    | 18     | M10 | 30 | 10.5 | 3.5  |   |   |  |           |
| AEMR-RD0702-D25-M12-L35-Z05-H                      | ●                      | 25  | 5    | 21     | M12 | 35 | 12.5 | 3.5  |   |   |  |           |
| AEMR-RD0702-D30-M16-L42-Z05-H                      | ●                      | 30  | 5    | 29     | M16 | 42 | 17   | 3.5  |   |   |  |           |
| AEMR-RD0702-D32-M16-L43-Z05-H                      | ●                      | 32  | 5    | 29     | M16 | 43 | 17   | 3.5  |   |   |  |           |
| AEMR-RD0702-D35-M16-L42-Z06-H                      | ●                      | 35  | 6    | 29     | M16 | 42 | 17   | 3.5  |   |   |  |           |
| AEMR-RD0702-D42-M16-L43-Z05-H                      | ●                      | 42  | 5    | 29     | M16 | 43 | 17   | 3.5  |   |   |  |           |
| AEMR-RD0702-D42-M16-L43-Z07-H                      | ●                      | 42  | 7    | 29     | M16 | 43 | 17   | 3.5  | RD.. 0802                                 | 3008-M2.5x6                                 | 82-T08                                     |           |
| AEMR-RD08T2-D16-M08-L23-Z02-H                      | ●                      | 16  | 2    | 13     | M08 | 23 | 8.5  | 4    |   |   |  |           |
| AEMR-RD08T2-D16-M10-L23-Z02-H                      | ●                      | 16  | 2    | 13     | M10 | 23 | 8.5  | 4    |   |   |  |           |
| AEMR-RD08T2-D20-M10-L30-Z03-H                      | ●                      | 20  | 3    | 18     | M10 | 30 | 10.5 | 4    |   |   |  |           |
| AEMR-RD08T2-D25-M12-L35-Z04-H                      | ●                      | 25  | 4    | 21     | M12 | 35 | 12.5 | 4    |   |   |  |           |
| AEMR-RD0802-D16-M08-L23-Z02-H                      | ●                      | 16  | 2    | 13     | M08 | 23 | 8.5  | 4    |   |   |  |           |
| AEMR-RD0803-D16-M08-L23-Z02-H                      | ●                      | 16  | 2    | 13     | M08 | 23 | 8.5  | 4    |   |   |  |           |
| AEMR-RD0803-D20-M10-L30-Z03-H                      | ●                      | 20  | 3    | 18     | M10 | 30 | 10.5 | 4    |   |   |  |           |
| AEMR-RD0803-D25-M12-L35-Z04-H                      | ●                      | 25  | 4    | 21     | M12 | 35 | 12.5 | 4    | RD.. 1003                                 | 4015-M3.5x9                                 | 80-T15                                     |           |
| AEMR-RD1003-D20-M10-L30-Z02-H                      | ●                      | 20  | 2    | 18     | M10 | 30 | 10.5 | 5    |   |   |  |           |
| AEMR-RD1003-D25-M12-L35-Z02-H                      | ●                      | 25  | 2    | 21     | M12 | 35 | 12.5 | 5    |   |   |  |           |
| AEMR-RD1003-D25-M12-L35-Z03-H                      | ●                      | 25  | 3    | 21     | M12 | 35 | 12.5 | 5    |   |   |  |           |
| AEMR-RD1003-D30-M16-L43-Z04-H                      | ●                      | 30  | 4    | 29     | M16 | 43 | 17   | 5    |   |   |  |           |
| AEMR-RD1003-D32-M16-L43-Z04-H                      | ●                      | 32  | 4    | 29     | M16 | 43 | 17   | 5    |   |   |  |           |
| AEMR-RD1003-D35-M16-L43-Z04-H                      | ●                      | 35  | 4    | 29     | M16 | 43 | 17   | 5    |   |   |  |           |
| AEMR-RD1003-D40-M16-L43-Z05-H                      | ●                      | 40  | 5    | 29     | M16 | 43 | 17   | 5    |   |   |  |           |
| AEMR-RD1003-D42-M16-L43-Z05-H                      | ●                      | 42  | 5    | 29     | M16 | 43 | 17   | 5    | RD.. 10T3                                 | 4015-M3.5x9                                 | 80-T15                                     |           |
| AEMR-RD10T3-D25-M12-L35-Z03-H                      | ●                      | 25  | 3    | 21     | M12 | 35 | 12.5 | 5    |   |   |  |           |
| AEMR-RD10T3-D32-M16-L45-Z04-H                      | ●                      | 32  | 4    | 29     | M16 | 45 | 17   | 5    |   |   |  |           |
| new AEMR-RD10T3-D35-M16-L43-Z04-H                  | ●                      | 35  | 4    | 29     | M16 | 43 | 17   | 5    |   |   |  |           |
| new AEMR-RD10T3-D42-M16-L43-Z05-H                  | ●                      | 42  | 5    | 29     | M16 | 43 | 17   | 5    |   |   |  |           |
| new AEMR-RD1004-D25-M12-L35-Z03-H                  | ●                      | 25  | 3    | 21     | M12 | 35 | 12.5 | 5    |   |   |  |           |
| AEMR-RD1004-D32-M16-L43-Z04-H                      | ●                      | 32  | 4    | 29     | M16 | 43 | 17   | 5    |   |   |  |           |
| AEMR-RD1004-D42-M16-L43-Z05-H                      | ●                      | 42  | 5    | 29     | M16 | 43 | 17   | 5    |   |   |  | RD.. 12T3 |
| AEMR-RD12T3-D24-M12-L35-Z02-H                      | ●                      | 24  | 2    | 21     | M12 | 35 | 12.5 | 6    |   |   |  |           |
| AEMR-RD12T3-D25-M12-L35-Z02-H                      | ●                      | 25  | 2    | 21     | M12 | 35 | 12.5 | 6    |   |   |  |           |
| AEMR-RD12T3-D32-M16-L43-Z03-H                      | ●                      | 32  | 3    | 29     | M16 | 43 | 17   | 6    |   |   |  |           |
| AEMR-RD12T3-D35-M16-L43-Z03-H                      | ●                      | 35  | 3    | 29     | M16 | 43 | 17   | 6    |   |   |  |           |
| AEMR-RD12T3-D35-M16-L43-Z04-H                      | ●                      | 35  | 4    | 29     | M16 | 43 | 17   | 6    |   |   |  |           |
| AEMR-RD12T3-D40-M16-L43-Z04-H                      | ●                      | 40  | 4    | 29     | M16 | 43 | 17   | 6    |   |   |  |           |
| AEMR-RD12T3-D42-M16-L43-Z05-H                      | ●                      | 42  | 5    | 29     | M16 | 43 | 17   | 6    | RD.. 1204                                 | 4015-M4.5x11                                | 80-T15                                     |           |
| new AEMR-RD1204-D25-M12-L35-Z02-H                  | ●                      | 25  | 2    | 21     | M12 | 35 | 12.5 | 6    |   |   |  |           |
| AEMR-RD1204-D32-M16-L43-Z03-H                      | ●                      | 32  | 3    | 29     | M16 | 43 | 17   | 6    |   |   |  |           |
| new AEMR-RD1204-D40-M16-L43-Z04-H                  | ●                      | 40  | 4    | 29     | M16 | 43 | 17   | 6    |   |   |  |           |
| AEMR-RD1204-D42-M16-L43-Z04-H                      | ●                      | 42  | 4    | 29     | M16 | 43 | 17   | 6    |   |   |  |           |
| AEMR-RD1604-D32-M16-L43-Z02-H                      | ●                      | 32  | 2    | 29     | M16 | 43 | 17   | 8    |   |   |  |           |
| AEMR-RD1604-D40-M16-L43-Z02-H                      | ●                      | 40  | 2    | 29     | M16 | 43 | 17   | 8    |   |   |  |           |
| AEMR-RD1604-D42-M16-L43-Z03-H                      | ●                      | 42  | 3    | 29     | M16 | 43 | 17   | 8    |   |   |  |           |

R: Sağ / Right / Rechts/ L: Sol / Left / Links

● Stokta / In Stock / Auf Lager ○ Stokta Yok / Non Stock Item / Kein Lagerartikel, Lieferzeit auf Anfrage  
ISO Uçuna Uygundur. / Compatible with ISO Insert. / Kompatibel mit ISO Wendepplatten.

Sipariş Örneği/Ordering Example/Bestellbeispiel

1 ad./pcs./stück AEMR-RD0702-D15-M08-L23-Z02-H

Kesme Hesabı : S 377/ Cutting Calculation : P 377 / Schnittberechnung : P 377

Sıkma Tork Değeri : S 376 / Tightening Torque : P 376 / Anzugsmoment : P 376

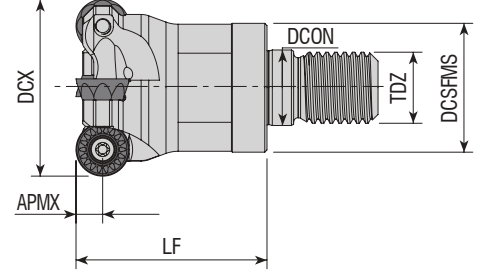

| Takım Kodu<br>Ordering Code<br>Bestell-Bezeichnung | Stok<br>Stock<br>Lager | Takım Ölçüleri (mm)<br>Dimension (mm)<br>Abmessung (mm) |      |        |     |    |      |      | Kesici Uç<br>Insert<br>Wendeschneidplatte | Yedek Parçaları / Spare Parts / Ersatzteile |  |
|--|------------------------|---|------|--------|-----|----|------|------|---|---|--|
|  |                        | DCX   | ZEFP | DCSFMS | TDZ | LF | DCON | APMX |   | Sıkma Vidası<br>Screw<br>Schraube           | Tork Anahtar<br>Torx Key<br>Torx-Schlüssel |
| AEMR-RP10T3A-D32-M16-L43-Z04-H                     | ●                      | 32  | 4    | 29     | M16 | 43 | 17   | 5    |   |   |  |
| AEMR-RP10T3A-D42-M16-L43-Z05-H                     | ●                      | 42  | 5    | 29     | M16 | 43 | 17   | 5    |   |   |  |

ACHTK Ucuna Uygunur. / Compatible with ACHTK Insert. / Kompatibel mit ACHTK Wendeplatten.

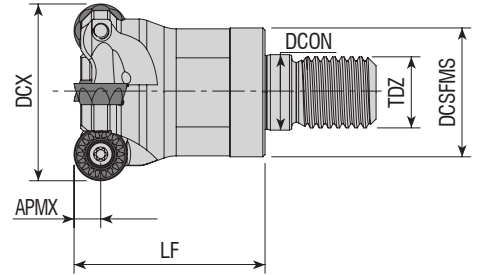

| Takım Kodu<br>Ordering Code<br>Bestell-Bezeichnung | Stok<br>Stock<br>Lager | Takım Ölçüleri (mm)<br>Dimension (mm)<br>Abmessung (mm) |      |        |     |    |      |      | Kesici Uç<br>Insert<br>Wendeschneidplatte | Yedek Parçaları / Spare Parts / Ersatzteile |  |
|--|------------------------|---|------|--------|-----|----|------|------|---|---|--|
|  |                        | DCX   | ZEFP | DCSFMS | TDZ | LF | DCON | APMX |   | Sıkma Vidası<br>Screw<br>Schraube           | Tork Anahtar<br>Torx Key<br>Torx-Schlüssel |
| AEMR-RP10T3K-D32-M16-L43-Z04-H                     | ●                      | 32  | 4    | 29     | M16 | 43 | 17   | 5    |   |   |  |
| AEMR-RP10T3K-D42-M16-L43-Z05-H                     | ●                      | 43  | 5    | 29     | M16 | 43 | 17   | 5    |   |   |  |

R: Sağ / Right / Rechts/ L: Sol / Left / Links

● Stokta / In Stock / Auf Lager ○ Stokta Yok / Non Stock Item / Kein Lagerartikel, Lieferzeit auf Anfrage

KYCR Ucuna Uygunur. / Compatible with KYCR Insert. / Kompatibel mit KYCR Wendeplatten.

Sipariş Örneği/Ordering Example/Bestellbeispiel

1 ad./pcs./stück AEMR-RP10T3A-D32-M16-L43-Z04-H

Kesme Hesabı : S 377/ Cutting Calculation : P 377 / Schnittberechnung : P 377

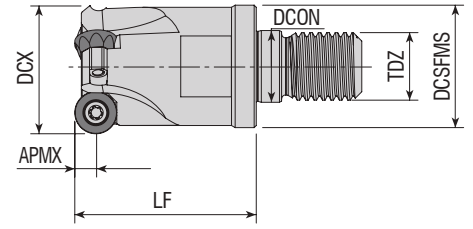

| Takım Kodu<br>Ordering Code<br>Bestell-Bezeichnung | Stok<br>Stock<br>Lager | Takım Ölçüleri (mm)<br>Dimension (mm)<br>Abmessung (mm) |      |        |     |    |      |      | Kesici Uç<br>Insert<br>Wendeschneidplatte | Yedek Parçaları / Spare Parts / Ersatzteile |  |
|--|------------------------|---|------|--------|-----|----|------|------|---|---|--|
|  |                        | DCX   | ZEFP | DCSFMS | TDZ | LF | DCON | APMX |   | Sıkma Vidası<br>Screw<br>Schraube           | Tork Anahtar<br>Torx Key<br>Torx-Schlüssel |
| AEMR-QP10T3-D25-M12-L35-Z02-H                      | ●                      | 25  | 2    | 21     | M12 | 35 | 12.5 | 5    |   |   |  |
| AEMR-QP10T3-D32-M16-L43-Z03-H                      | ●                      | 32  | 3    | 29     | M16 | 43 | 17   | 5    |   |   |  |

SMTM Ucuna Uygun. / Compatible with SMTM Insert. / Kompatibel mit SMTM Wendeplatten.

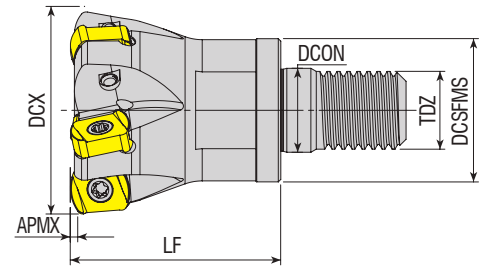

| Takım Kodu<br>Ordering Code<br>Bestell-Bezeichnung | Stok<br>Stock<br>Lager | Takım Ölçüleri (mm)<br>Dimension (mm)<br>Abmessung (mm) |      |        |     |    |      |      | Kesici Uç<br>Insert<br>Wendeschneidplatte | Yedek Parçaları / Spare Parts / Ersatzteile |  |                    |             |        |
|--|------------------------|---|------|--------|-----|----|------|------|---|---|--|--------------------|-------------|--------|
|  |                        | DCX   | ZEFP | DCSFMS | TDZ | LF | DCON | APMX |   | Sıkma Vidası<br>Screw<br>Schraube           | Tork Anahtar<br>Torx Key<br>Torx-Schlüssel |                    |             |        |
| AHFM-BL0603-D20-M10-L30-Z03-H                      | ●                      | 20  | 3    | 18     | M10 | 30 | 10.5 | 1    |   |   |  |                    |             |        |
| <b>new</b> AHFM-BL0603-D25-M12-L35-Z04-H           | ●                      | 25  | 4    | 21     | M12 | 35 | 12.5 | 1    |   |   |  | <b>BLMP 0603..</b> | 3008-M2.5x6 | 82-T08 |
| AHFM-BL0603-D32-M16-L40-Z05-H                      | ●                      | 32  | 5    | 29     | M16 | 40 | 17   | 1    |   |   |  |                    |             |        |
| AHFM-BL0904-D32-M16-L40-Z04-H                      | ●                      | 32  | 4    | 29     | M16 | 40 | 17   | 1.5  |   |   |  | <b>BLMP 0904..</b> | 3010-M3.5x9 | 82-T10 |
| AHFM-BL0904-D32-M16-L43-Z04-H                      | ●                      | 32  | 4    | 29     | M16 | 43 | 17   | 1.5  |   |   |  |                    |             |        |
| AHFM-BL0904-D42-M16-L43-Z05-H                      | ●                      | 42  | 5    | 29     | M16 | 43 | 17   | 1.5  |   |   |  |                    |             |        |

R: Sağ / Right / Rechts L: Sol / Left / Links

● Stokta / In Stock / Auf Lager ○ Stokta Yok / Non Stock Item / Kein Lagerartikel, Lieferzeit auf Anfrage

TGTC Ucuna Uygun. / Compatible with TGTC Insert. / Kompatibel mit TGTC Wendeplatten.

Sipariş Örneği/Ordering Example/Bestellbeispiel

1 ad./pcs./stück AEMR-QP10T3-D25-M12-L35-Z02-H

Kesme Hesabı : S 377 / Cutting Calculation : P 377 / Schnittberechnung : P 377

Sıkma Tork Değeri : S 376 / Tightening Torque : P 376 / Anzugsmoment : P 376

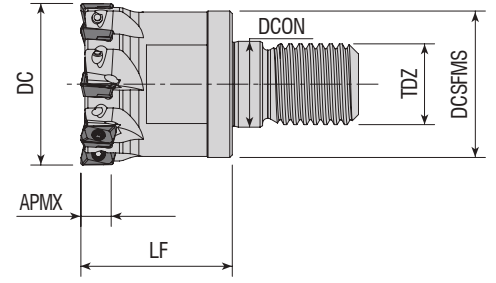

| Takım Kodu<br>Ordering Code<br>Bestell-Bezeichnung | Stok<br>Stock<br>Lager | Takım Ölçüleri (mm)<br>Dimension (mm)<br>Abmessung (mm) |      |        |     |    |      |      | Kesici Uç<br>Insert<br>Wendeschneidplatte | Yedek Parçaları / Spare Parts / Ersatzteile |  |
|--|------------------------|---|------|--------|-----|----|------|------|---|---|--|
|  |                        | DC  | ZEFP | DCSFMS | TDZ | LF | DCON | APMX |   | Sıkma Vidası<br>Screw<br>Schraube           | Tork Anahtar<br>Torx Key<br>Torx-Schlüssel |
| AHFM-ED0702-D12-M06-L20-Z03                        | ●                      | 12  | 3    | 10     | M06 | 20 | 6.5  | 6    | EDMT 0702<br>JDMT 070204                  | 3006-M1.8x4                                 | 82-T06                                     |
| AHFM-ED0702-D16-M08-L25-Z04-H                      | ●                      | 16  | 4    | 14.75  | M08 | 25 | 8.5  | 6    |   |   |  |
| AHFM-ED0702-D20-M10-L30-Z05-H                      | ●                      | 20  | 5    | 18     | M10 | 30 | 10.5 | 6    |   |   |  |
| AHFM-ED0702-D25-M12-L30-Z06-H                      | ●                      | 25  | 6    | 21     | M12 | 30 | 12.5 | 6    |   |   |  |
| AHFM-ED0702-D32-M16-L30-Z08-H                      | ●                      | 32  | 8    | 29     | M16 | 30 | 17   | 6    |   |   |  |

HTCH Ucuna Uygundur. / Compatible with HTCH Insert. / Kompatibel mit HTCH Wendeplatten.

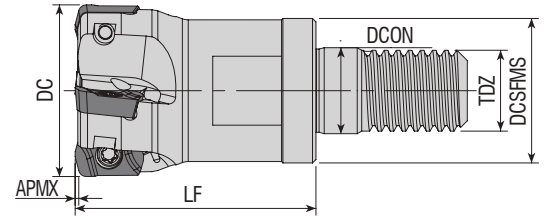

| Takım Kodu<br>Ordering Code<br>Bestell-Bezeichnung | Stok<br>Stock<br>Lager | Takım Ölçüleri (mm)<br>Dimension (mm)<br>Abmessung (mm) |      |        |     |    |      |      | Kesici Uç<br>Insert<br>Wendeschneidplatte | Yedek Parçaları / Spare Parts / Ersatzteile |  |
|--|------------------------|---|------|--------|-----|----|------|------|---|---|--|
|  |                        | DC  | ZEFP | DCSFMS | TDZ | LF | DCON | APMX |   | Sıkma Vidası<br>Screw<br>Schraube           | Tork Anahtar<br>Torx Key<br>Torx-Schlüssel |
| new AHFM-EP1003-D16-M08-L23-Z02                    | ●                      | 16  | 2    | 14.75  | M08 | 23 | 8.5  | 1    | EP. 1003..<br>ZPMT 1003..<br>YPHW 1003..  | 3008-M2.5x5                                 | 82-T08                                     |
| AHFM-EP1003-D16-M08-L23-Z02-H                      | ●                      | 16  | 2    | 14.75  | M08 | 23 | 8.5  | 1    |   |   |  |
| new AHFM-EP1003-D20-M10-L30-Z03                    | ●                      | 20  | 3    | 18     | M10 | 30 | 10.5 | 1    |   |   |  |
| AHFM-EP1003-D20-M10-L30-Z04-H                      | ●                      | 20  | 4    | 18     | M10 | 30 | 10.5 | 1    |   |   |  |
| AHFM-EP1003-D25-M12-L35-Z04-H                      | ●                      | 25  | 4    | 21     | M12 | 35 | 12.5 | 1    |   |   |  |
| AHFM-EP1003-D32-M16-L43-Z05-H                      | ●                      | 32  | 5    | 29     | M16 | 43 | 17   | 1    |   |   |  |
| AHFM-EP1003-D35-M16-L43-Z05-H                      | ●                      | 35  | 5    | 29     | M16 | 43 | 17   | 1    |   |   |  |
| AHFM-EP1003-D42-M16-L43-Z06-H                      | ●                      | 42  | 6    | 29     | M16 | 43 | 17   | 1    |   |   |  |

R: Sağ / Right / Rechts/ L: Sol / Left / Links

● Stokta / In Stock / Auf Lager ○ Stokta Yok / Non Stock Item / Kein Lagerartikel, Lieferzeit auf Anfrage

DJT Ucuna Uygundur. / Compatible with DJT Insert. / Kompatibel mit DJT Wendeplatten.

Sipariş Örneği/Ordering Example/ Bestellbeispiel

1 ad./pcs./stück AHFM-ED0702-D12-M06-L20-Z03

Kesme Hesabı : S 377 / Cutting Calculation : P 377 / Schnittberechnung : P 377

Sıkma Tork Değeri : S 376 / Tightening Torque : P 376 / Anzugsmoment : P 376

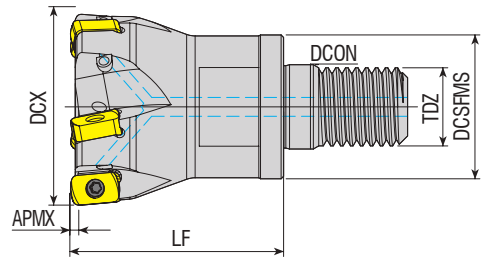

| Takım Kodu<br>Ordering Code<br>Bestell-Bezeichnung | Stok<br>Stock<br>Lager | Takım Ölçüleri (mm)<br>Dimension (mm)<br>Abmessung (mm) |      |        |     |    |      | Kesici Uç<br>Insert<br>Wendeschneidplatte | Yedek Parçaları / Spare Parts / Ersatzteile |                                   |   |   |  |
|--|------------------------|---|------|--------|-----|----|------|---|---|-----------------------------------|---|---|--|
|  |                        | DCX   | ZEFP | DCSFMS | TDZ | LF | DCON |   | APMX  | Sıkma Vidası<br>Screw<br>Schraube | Baskı Parçası<br>Wedge Clamp<br>Spannpratze | Baskı Vidası<br>Clamp Screw<br>Schraube | Tork Anahtar<br>Torx Key<br>Torx-Schlüssel |
| AHFM-EN1004-D16-M08-L23-Z02-H                      | ●                      | 16  | 2    | 14.75  | M08 | 23 | 8.5  | 1   | ENMU 1004..                                 | 3008-M2.5x5                       |   |   | 82-T08                                     |
| AHFM-EN1004-D20-M10-L30-Z03-H                      | ●                      | 20  | 3    | 18     | M10 | 30 | 10.5 | 1   |   |                                   |   |   |  |
| AHFM-EN1004-D25-M12-L35-Z03-H                      | ●                      | 25  | 3    | 21     | M12 | 35 | 12.5 | 1   |   |                                   |   |   |  |
| AHFM-EN1004-D25-M12-L35-Z04-H                      | ●                      | 25  | 4    | 21     | M12 | 35 | 12.5 | 1   |   |                                   |   |   |  |
| AHFM-EN1004-D32-M16-L43-Z05-H                      | ●                      | 32  | 5    | 29     | M16 | 43 | 17   | 1   |   |                                   |   |   |  |
| AHFM-EN1004-D35-M16-L43-Z05-H                      | ●                      | 35  | 5    | 29     | M16 | 43 | 17   | 1   |   |                                   |   |   |  |
| AHFM-EN1004-D40-M16-L43-Z05-H                      | ●                      | 40  | 5    | 29     | M16 | 43 | 17   | 1   |   |                                   |   |   |  |
| AHFM-EN1004-D42-M16-L43-Z05-H                      | ●                      | 42  | 5    | 29     | M16 | 43 | 17   | 1   |   |                                   |   |   |  |

DJT Ucuna Uygunudur. / Compatible with DJT Insert. / Kompatibel mit DJT Wendeplatten.

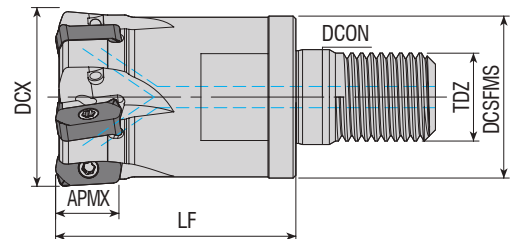

| Takım Kodu<br>Ordering Code<br>Bestell-Bezeichnung | Stok<br>Stock<br>Lager | Takım Ölçüleri (mm)<br>Dimension (mm)<br>Abmessung (mm) |      |        |     |    |      | Kesici Uç<br>Insert<br>Wendeschneidplatte | Yedek Parçaları / Spare Parts / Ersatzteile |                                   |   |   |  |
|--|------------------------|---|------|--------|-----|----|------|---|---|-----------------------------------|---|---|--|
|  |                        | DCX   | ZEFP | DCSFMS | TDZ | LF | DCON |   | APMX  | Sıkma Vidası<br>Screw<br>Schraube | Baskı Parçası<br>Wedge Clamp<br>Spannpratze | Baskı Vidası<br>Clamp Screw<br>Schraube | Tork Anahtar<br>Torx Key<br>Torx-Schlüssel |
| AHFM-LN0303-D25-M12-L35-Z04-H                      | ●                      | 25  | 4    | 21     | M12 | 35 | 12.5 | 12  | LNMU 0303..                                 | 3008-M2.5x6                       |   |   | 82-T08                                     |
| AHFM-LN0303-D32-M16-L43-Z05-H                      | ●                      | 32  | 5    | 29     | M16 | 43 | 17   | 12  |   |                                   |   |   |  |
| AHFM-LN0303-D42-M16-L43-Z06-H                      | ●                      | 42  | 6    | 29     | M16 | 43 | 17   | 12  |   |                                   |   |   |  |

R: Sağ / Right / Rechtsl L: Sol / Left / Links

● Stokta / In Stock / Auf Lager ○ Stokta Yok / Non Stock Item / Kein Lagerartikel, Lieferzeit auf Anfrage

TNGLY Ucuna Uygunudur. / Compatible with TNGLY Insert. / Kompatibel mit TNGLY Wendeplatten.

Sipariş Örneği/Ordering Example/Bestellbeispiel

1 ad./pcs./stück AHFM-EN1004-D16-M08-L23-Z02-H

Kesme Hesabı : S 377 / Cutting Calculation : P 377 / Schnittberechnung : P 377

Sıkma Tork Değeri : S 376 / Tightening Torque : P 376 / Anzugsmoment : P 376

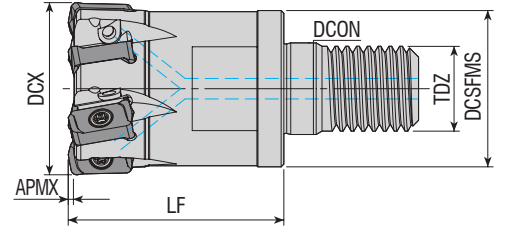

| Takım Kodu<br>Ordering Code<br>Bestell-Bezeichnung | Stok<br>Stock<br>Lager | Takım Ölçüleri (mm)<br>Dimension (mm)<br>Abmessung (mm) |      |        |     |    |      | Kesici Uç<br>Insert<br>Wendeschneidplatte | Yedek Parçaları / Spare Parts / Ersatzteile |                                   |   |   |  |
|--|------------------------|---|------|--------|-----|----|------|---|---|-----------------------------------|---|---|--|
|  |                        | DCX   | ZEPF | DCSFMS | TDZ | LF | DCON |   | APMX  | Sıkma Vidası<br>Screw<br>Schraube | Baskı Parçası<br>Wedge Clamp<br>Spannpratze | Baskı Vidası<br>Clamp Screw<br>Schraube | Tork Anahtar<br>Torx Key<br>Torx-Schlüssel |
| AHFM-L003-D20-M10-L30-Z04-H-F                      | ●                      | 20  | 4    | 18     | M10 | 30 | 10.5 | 1   | LOGU 0303..                                 | 1108-M3x6.8                       | -   | -                                       | 82-T08                                     |
| AHFM-L003-D25-M12-L35-Z04-H-F                      | ●                      | 25  | 4    | 21     | M12 | 35 | 12.5 | 1   |   |                                   |   |   |  |
| AHFM-L003-D25-M12-L35-Z04-H                        | ●                      | 25  | 4    | 21     | M12 | 35 | 12.5 | 1   |   |                                   |   |   |  |
| AHFM-L003-D32-M16-L40-Z05-H-F                      | ●                      | 32  | 5    | 29     | M16 | 40 | 17   | 1   |   |                                   |   |   |  |
| AHFM-L003-D32-M16-L40-Z05-H                        | ●                      | 32  | 5    | 29     | M16 | 40 | 17   | 1   |   |                                   |   |   |  |
| AHFM-L003-D32-M16-L40-Z06-H-F                      | ●                      | 32  | 6    | 29     | M16 | 40 | 17   | 1   |   |                                   |   |   |  |
| AHFM-L003-D32-M16-L40-Z06-H                        | ●                      | 32  | 6    | 29     | M16 | 40 | 17   | 1   |   |                                   |   |   |  |
| AHFM-L003-D35-M16-L40-Z05-H                        | ●                      | 35  | 5    | 29     | M16 | 40 | 17   | 1   |   |                                   |   |   |  |
| AHFM-L003-D35-M16-L40-Z06-H                        | ●                      | 35  | 6    | 29     | M16 | 40 | 17   | 1   |   |                                   |   |   |  |
| AHFM-L003-D42-M16-L40-Z05-H                        | ●                      | 42  | 5    | 29     | M16 | 40 | 17   | 1   |   |                                   |   |   |  |
| AHFM-L003-D42-M16-L40-Z06-H                        | ●                      | 42  | 6    | 29     | M16 | 40 | 17   | 1   |   |                                   |   |   |  |

R: Sağ / Right / Rechts / L: Sol / Left / Links

● Stokta / In Stock / Auf Lager ○ Stokta Yok / Non Stock Item / Kein Lagerartikel, Lieferzeit auf Anfrage  
KYCR Ucuna Uygun / Compatible with KYCR Insert. / Kompatibel mit KYCR Wendeplatten.

F: Eksenel ve Radyal Salgı Değeri 0,02 mm içindedir. / F: Axial and Radial Runout Value is within 0,02 mm.

F: Der axiale und radiale Rundlaufwert liegt innerhalb von 0,02 mm.

Kesme Hesabı : S 367 / Cutting Calculation : P 367 / Schnittberechnung : P 367

Sıkma Tork Değeri : S 367 / Tightening Torque : P 367 / Anzugsmoment : P 367

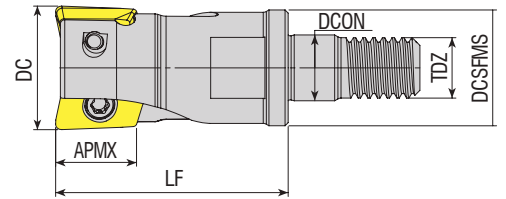

| Takım Kodu<br>Ordering Code<br>Bestell-Bezeichnung | Stok<br>Stock<br>Lager | Takım Ölçüleri (mm)<br>Dimension (mm)<br>Abmessung (mm) |      |        |     |    |      | Kesici Uç<br>Insert<br>Wendeschneidplatte | Yedek Parçaları / Spare Parts / Ersatzteile |                                   |  |
|--|------------------------|---|------|--------|-----|----|------|---|---|-----------------------------------|--|
|  |                        | DC  | ZEPF | DCSFMS | TDZ | LF | DCON |   | APMX  | Sıkma Vidası<br>Screw<br>Schraube | Tork Anahtar<br>Torx Key<br>Torx-Schlüssel |
| AHFM-JD1003-D16-M08-L30-Z02-H                      | ●                      | 16  | 2    | 14.75  | M08 | 30 | 8.5  | 9   | JDMT 1003..                                 | 3008-M2.5x6                       | 82-T08                                     |
| AHFM-JD1003-D20-M10-L30-Z03-H                      | ●                      | 20  | 3    | 18     | M10 | 30 | 10.5 | 9   |   |                                   |  |

HTCH Ucuna Uygun / Compatible with HTCH Insert. / Kompatibel mit HTCH Wendeplatten.

Sipariş Örneği/Ordering Example/Bestellbeispiel  
1 ad./pcs./stück AHFM-L003-D20-M10-L30-Z04-H-F



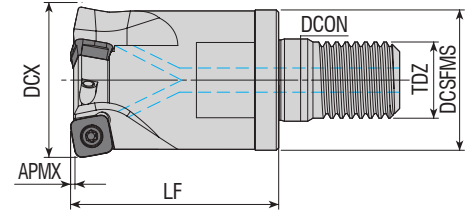

| Takım Kodu<br>Ordering Code<br>Bestell-Bezeichnung | Stok<br>Stock<br>Lager | Takım Ölçüleri (mm)<br>Dimension (mm)<br>Abmessung (mm) |      |        |     |    |      |      | Kesici Uç<br>Insert<br>Wendeschneidplatte | Yedek Parçaları / Spare Parts / Ersatzteile |  |  |
|--|------------------------|---|------|--------|-----|----|------|------|---|---|--|--|
|  |                        | DCX   | ZEFP | DCSFMS | TDZ | LF | DCON | APMX |   | Sıkma Vidası<br>Screw<br>Schraube           | Tork Anahtar<br>Torx Key<br>Torx-Schlüssel |  |
| AHFM-SD1205-D32-M16-L40-Z03-H                      | ●                      | 32  | 3    | 29     | M16 | 40 | 17   | 2    |   |   |  |  |
| AHFM-SD1205-D35-M16-L40-Z03-H                      | ●                      | 35  | 3    | 29     | M16 | 40 | 17   | 2    |   |   |  |  |
| AHFM-SD1205-D40-M16-L43-Z03-H                      | ●                      | 40  | 3    | 29     | M16 | 43 | 17   | 2    |   |   |  |  |
| AHFM-SD1205-D42-M16-L43-Z03-H                      | ●                      | 42  | 3    | 29     | M16 | 43 | 17   | 2    |   |   |  |  |

HTCH Ucuna Uygundur. / Compatible with HTCH Insert. / Kompatibel mit HTCH Wendeplatten.

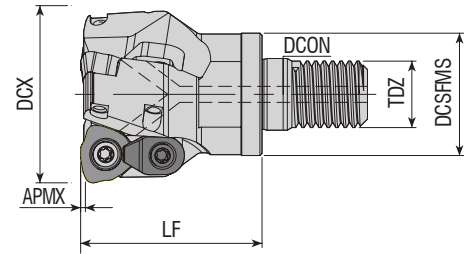

| Takım Kodu<br>Ordering Code<br>Bestell-Bezeichnung | Stok<br>Stock<br>Lager | Takım Ölçüleri (mm)<br>Dimension (mm)<br>Abmessung (mm) |      |        |     |    |      |      | Kesici Uç<br>Insert<br>Wendeschneidplatte | Yedek Parçaları / Spare Parts / Ersatzteile |   |   |  |
|--|------------------------|---|------|--------|-----|----|------|------|---|---|---|---|--|
|  |                        | DCX   | ZEFP | DCSFMS | TDZ | LF | DCON | APMX |   | Sıkma Vidası<br>Screw<br>Schraube           | Baskı Parçası<br>Wedge Clamp<br>Spannpratze | Baskı Vidası<br>Clamp Screw<br>Schraube | Tork Anahtar<br>Torx Key<br>Torx-Schlüssel |
| AHFMC-JD1204-D32-M16-L43-Z02-H                     | ●                      | 32  | 2    | 29     | M16 | 43 | 17   | 1.5  |   |   |   |   |  |
| AHFMC-JD1204-D42-M16-L43-Z03-H                     | ●                      | 42  | 3    | 29     | M16 | 43 | 17   | 1.5  |   |   |   |   |  |

R: Sağ / Right / Rechts L: Sol / Left / Links

● Stokta / In Stock / Auf Lager ○ Stokta Yok / Non Stock Item / Kein Lagerartikel, Lieferzeit auf Anfrage

MTSBH Ucuna Uygundur. / Compatible with MTSBH Insert. / Kompatibel mit MTSBH Wendeplatten.

Sipariş Örneği/Ordering Example/Bestellbeispiel  
1 ad./pcs./stück AHFM-SD1205-D32-M16-L40-Z03-H

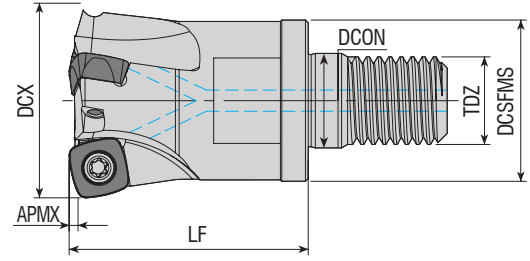

| Takım Kodu<br>Ordering Code<br>Bestell-Bezeichnung | Stok<br>Stock<br>Lager | Takım Ölçüleri (mm)<br>Dimension (mm)<br>Abmessung (mm) |      |         |     |    |      |      | Kesici Uç<br>Insert<br>Wendeschneidplatte | Yedek Parçaları / Spare Parts / Ersatzteile |  |
|--|------------------------|---|------|---------|-----|----|------|------|---|---|--|
|  |                        | DCX   | ZEFP | DC SFMS | TDZ | LF | DCON | APMX |   | Sıkma Vidası<br>Screw<br>Schraube           | Tork Anahtar<br>Torx Key<br>Torx-Schlüssel |
| AHFM-SP0735-D16-M08-L23-Z02-H                      | ●                      | 16  | 2    | 14.75   | M08 | 23 | 8.5  | 1.2  | SPMX 073505                               |   |  |
| AHFM-SP0735-D20-M10-L30-Z03-H                      | ●                      | 20  | 3    | 18      | M10 | 30 | 10.5 | 1.2  |   |   |  |
| AHFM-SP0735-D25-M12-L35-Z04-H                      | ●                      | 25  | 4    | 21      | M12 | 35 | 12.5 | 1.2  |   |   |  |

MTSBH Ucuna Uygunur. / Compatible with MTSBH Insert. / Kompatibel mit MTSBH Wendeplatten.

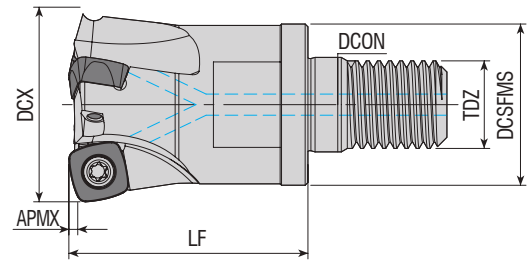

| Takım Kodu<br>Ordering Code<br>Bestell-Bezeichnung | Stok<br>Stock<br>Lager | Takım Ölçüleri (mm)<br>Dimension (mm)<br>Abmessung (mm) |      |         |     |    |      |      | Kesici Uç<br>Insert<br>Wendeschneidplatte | Yedek Parçaları / Spare Parts / Ersatzteile |  |
|--|------------------------|---|------|---------|-----|----|------|------|---|---|--|
|  |                        | DCX   | ZEFP | DC SFMS | TDZ | LF | DCON | APMX |   | Sıkma Vidası<br>Screw<br>Schraube           | Tork Anahtar<br>Torx Key<br>Torx-Schlüssel |
| AHFM-SP0945-D32-M16-L43-Z04-H                      | ●                      | 32  | 4    | 29      | M16 | 43 | 17   | 1.4  | SPMX 094506                               |   |  |
| AHFM-SP0945-D35-M16-L43-Z04-H                      | ●                      | 35  | 4    | 29      | M16 | 43 | 17   | 1.4  |   |   |  |
| AHFM-SP0945-D42-M16-L43-Z05-H                      | ●                      | 42  | 5    | 29      | M16 | 43 | 17   | 1.4  |   |   |  |

R: Sağ / Right / Rechts L: Sol / Left / Links

● Stokta / In Stock / Auf Lager ○ Stokta Yok / Non Stock Item / Kein Lagerartikel, Lieferzeit auf Anfrage

MTSBH Ucuna Uygunur. / Compatible with MTSBH Insert. / Kompatibel mit MTSBH Wendeplatten.

Sipariş Örneği/Ordering Example/Bestellbeispiel

1 ad./pcs./stück AHFM-SP0735-D16-M08-L23-Z02-H

Kesme Hesabı : S 367 / Cutting Calculation : P 367 / Schnittberechnung : P 367

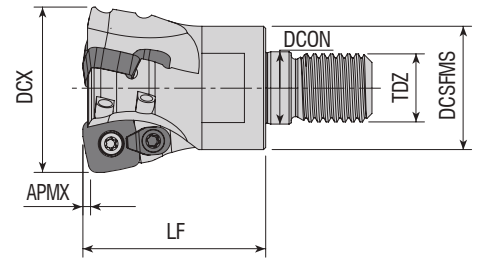

| Takım Kodu<br>Ordering Code<br>Bestell-Bezeichnung | Stok<br>Stock<br>Lager | Takım Ölçüleri (mm)<br>Dimension (mm)<br>Abmessung (mm) |      |        |     |    |      | Kesici Uç<br>Insert<br>Wendeschneidplatte | Yedek Parçaları / Spare Parts / Ersatzteile |                                   |   |   |  |
|--|------------------------|---|------|--------|-----|----|------|---|---|-----------------------------------|---|---|--|
|  |                        | DCX   | ZEFP | DCSFMS | TDZ | LF | DCON |   | APMX  | Sıkma Vidası<br>Screw<br>Schraube | Baskı Parçası<br>Wedge Clamp<br>Spannpratze | Baskı Vidası<br>Clamp Screw<br>Schraube | Tork Anahtar<br>Torx Key<br>Torx-Schlüssel |
| AHFM-SD06T2-D16-M08-L23-Z02-H                      | ●                      | 16  | 2    | 14.75  | M08 | 23 | 8.5  | 0.8                                       | SD.. 06T2..                                 | 3007-M2.2x4.6                     | -   | -                                       | 82-T07                                     |
| AHFM-SD06T2-D20-M10-L30-Z03-H                      | ●                      | 20  | 3    | 18     | M10 | 30 | 10.5 | 0.8                                       |   |                                   |   |   |  |
| AHFM-SD06T2-D25-M12-L35-Z04-H                      | ●                      | 25  | 4    | 21     | M12 | 35 | 12.5 | 0.8                                       |   |                                   |   |   |  |
| AHFMC-SD09T3-D25-M12-L30-Z02-H                     | ●                      | 25  | 2    | 22     | M12 | 30 | 12.5 | 1.4                                       | SD.. 09T3..                                 | 3010-M3.5x9                       | ACK-15                                      | 1510-M3.5x9                             | 82-T10                                     |
| AHFMC-SD09T3-D32-M16-L43-Z03-H                     | ●                      | 32  | 3    | 29     | M16 | 43 | 17   | 1.4                                       |   |                                   |   |   |  |
| AHFMC-SD09T3-D35-M16-L43-Z03-H                     | ●                      | 35  | 3    | 29     | M16 | 43 | 17   | 1.4                                       |   |                                   |   |   |  |
| AHFMC-SD09T3-D40-M16-L43-Z04-H                     | ●                      | 40  | 4    | 29     | M16 | 43 | 17   | 1.4                                       | SD.. 1204..                                 | 4015-M4x9                         |   | 4015-M3.5X11                            | 80-T15                                     |
| AHFMC-SD1204-D32-M16-L43-Z02-H                     | ●                      | 32  | 2    | 29     | M16 | 43 | 17   | 1.8                                       |   |                                   |   |   |  |
| AHFMC-SD1204-D40-M16-L43-Z03-H                     | ●                      | 40  | 3    | 29     | M16 | 43 | 17   | 1.8                                       |   |                                   |   |   |  |

ZCC Ucuna Uygun. / Compatible with ZCC Insert. / Kompatibel mit ZCC Wendeplatten.

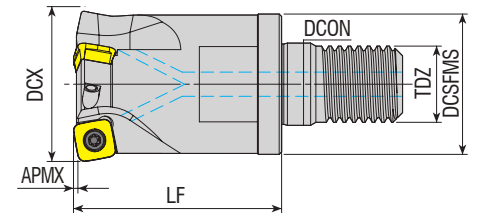

| Takım Kodu<br>Ordering Code<br>Bestell-Bezeichnung | Stok<br>Stock<br>Lager | Takım Ölçüleri (mm)<br>Dimension (mm)<br>Abmessung (mm) |      |        |     |    |      | Kesici Uç<br>Insert<br>Wendeschneidplatte | Yedek Parçaları / Spare Parts / Ersatzteile |                                   |   |   |  |
|--|------------------------|---|------|--------|-----|----|------|---|---|-----------------------------------|---|---|--|
|  |                        | DCX   | ZEFP | DCSFMS | TDZ | LF | DCON |   | APMX  | Sıkma Vidası<br>Screw<br>Schraube | Baskı Parçası<br>Wedge Clamp<br>Spannpratze | Baskı Vidası<br>Clamp Screw<br>Schraube | Tork Anahtar<br>Torx Key<br>Torx-Schlüssel |
| AHFM-S00803-D20-M10-L30-Z02-H                      | ●                      | 20  | 2    | 18     | M10 | 30 | 10.5 | 1   | SOMW 0803..                                 | 4010-M3X8                         | -   | -                                       | 82-T10                                     |
| AHFM-S00803-D25-M12-L35-Z03-H                      | ●                      | 25  | 3    | 22     | M12 | 35 | 12.5 | 1   |   |                                   |   |   |  |
| AHFM-S00803-D32-M16-L43-Z03-H                      | ●                      | 32  | 3    | 29     | M16 | 43 | 17   | 1   |   |                                   |   |   |  |
| AHFM-S00803-D32-M16-L43-Z04-H                      | ●                      | 32  | 4    | 29     | M16 | 43 | 17   | 1   |   |                                   |   |   |  |
| AHFM-S00803-D40-M16-L43-Z04-H                      | ●                      | 40  | 4    | 29     | M16 | 43 | 17   | 1   |   |                                   |   |   |  |

R: Sağ / Right / Rechts/ L: Sol / Left / Links

● Stokta / In Stock / Auf Lager ○ Stokta Yok / Non Stock Item / Kein Lagerartikel, Lieferzeit auf Anfrage

KPTK Ucuna Uygun. / Compatible with KPTK Insert. / Kompatibel mit KPTK Wendeplatten.

Sipariş Örneği/Ordering Example/Bestellbeispiel  
1 ad./pcs./stück AHFM-SD06T2-D16-M08-L23-Z02-H

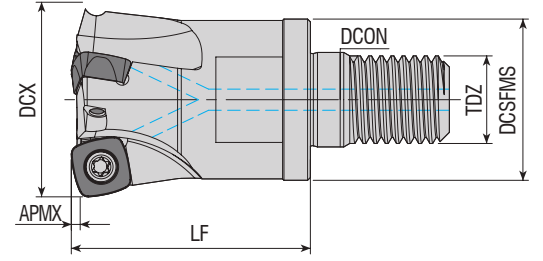

| Takım Kodu<br>Ordering Code<br>Bestell-Bezeichnung | Stok<br>Stock<br>Lager | Takım Ölçüleri (mm)<br>Dimension (mm)<br>Abmessung (mm) |      |         |     |    |      |      | Kesici Uç<br>Insert<br>Wendeschneidplatte | Yedek Parçaları / Spare Parts / Ersatzteile |  |  |
|--|------------------------|---|------|---------|-----|----|------|------|---|---|--|--|
|  |                        | DCX   | ZEPF | DC SFMS | TDZ | LF | DCON | APMX |   | Sıkma Vidası<br>Screw<br>Schraube           | Tork Anahtar<br>Torx Key<br>Torx-Schlüssel |  |
| AHFM-SO0803P-D32-M16-L35-Z04-H                     | ●                      | 32  | 4    | 29      | M16 | 35 | 17   | 1    | SOEW 0803                                 | 4010-M3x8                                   | 82-T10                                     |  |
| AHFM-SO0803P-D42-M16-L35-Z05-H                     | ●                      | 42  | 5    | 29      | M16 | 35 | 17   | 1    |   |   |  |  |

PLBT Ucuna Uygunur. / Compatible with PLBT Insert. / Kompatibel mit PLBT Wendeplatten.

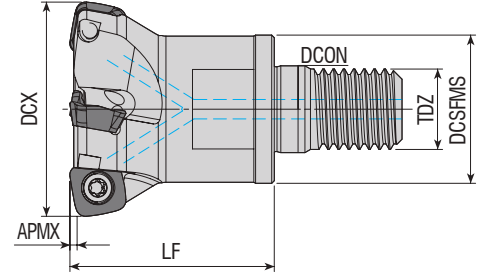

| Takım Kodu<br>Ordering Code<br>Bestell-Bezeichnung | Stok<br>Stock<br>Lager | Takım Ölçüleri (mm)<br>Dimension (mm)<br>Abmessung (mm) |      |        |     |    |      |      | Kesici Uç<br>Insert<br>Wendeschneidplatte | Yedek Parçaları / Spare Parts / Ersatzteile |   |   |  |
|--|------------------------|---|------|--------|-----|----|------|------|---|---|---|---|--|
|  |                        | DCX   | ZEPF | DCSFMS | TDZ | LF | DCON | APMX |   | Sıkma Vidası<br>Screw<br>Schraube           | Baskı Parçası<br>Wedge Clamp<br>Spannpratze | Baskı Vidası<br>Clamp Screw<br>Schraube | Tork Anahtar<br>Torx Key<br>Torx-Schlüssel |
| AHFM-SO1004-D32-M16-L40-Z03-H                      | ●                      | 32  | 3    | 29     | M16 | 40 | 17   | 1.5  | SOMT 1004..                               | 4015-M4x9                                   | -   | -                                       | 80-T15                                     |
| AHFM-SO1004-D40-M16-L40-Z04-H                      | ●                      | 40  | 4    | 29     | M16 | 40 | 17   | 1.5  |   |   |   |   |  |
| AHFM-SO1004-D42-M16-L40-Z04-H                      | ●                      | 42  | 4    | 29     | M16 | 40 | 17   | 1.5  |   |   |   |   |  |

KYCR Ucuna Uygunur. / Compatible with KYCR Insert. / Kompatibel mit KYCR Wendeplatten.

Sipariş Örneği/Ordering Example/Bestellbeispiel

1 ad./pcs./stück AHFM-SO0803P-D32-M16-L35-Z04-H  
Kesme Hesabı : S 377/ Cutting Calculation : P 377 / Schnittberechnung : P 377

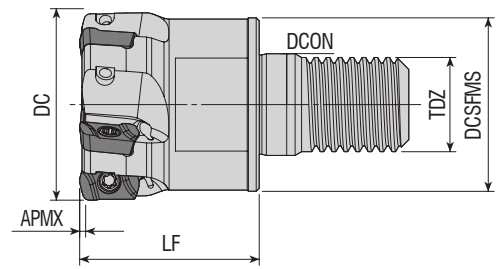

| Takım Kodu<br>Ordering Code<br>Bestell-Bezeichnung | Stok<br>Stock<br>Lager | Takım Ölçüleri (mm)<br>Dimension (mm)<br>Abmessung (mm) |      |        |     |    |      |      | Kesici Uç<br>Insert<br>Wendeschneidplatte | Yedek Parçaları / Spare Parts / Ersatzteile |   |   |  |
|--|------------------------|---|------|--------|-----|----|------|------|---|---|---|---|--|
|  |                        | DC  | ZEFP | DCSFMS | TDZ | LF | DCON | APMX |   | Sıkma Vidası<br>Screw<br>Schraube           | Baskı Parçası<br>Wedge Clamp<br>Spannpratze | Baskı Vidası<br>Clamp Screw<br>Schraube | Tork Anahtar<br>Torx Key<br>Torx-Schlüssel |
| AHFM-YP1003-D16-M08-L23-Z02-F                      | ●                      | 16  | 2    | 14.75  | M08 | 23 | 8.5  | 1    | EP. 1003..<br>ZPMT 1003..<br>YPHW 1003..  | 3008-M2.5x5                                 | -   | -                                       | 82-T08                                     |
| AHFM-YP1003-D16-M08-L23-Z02-H-F                    | ●                      | 16  | 2    | 14.75  | M08 | 23 | 8.5  | 1    |   |   |   |   |  |
| AHFM-YP1003-D17-M08-L23-Z02-H                      | ●                      | 17  | 2    | 14.75  | M08 | 23 | 8.5  | 1    |   |   |   |   |  |
| AHFM-YP1003-D17-M08-L23-Z02-H-F                    | ●                      | 17  | 2    | 14.75  | M08 | 23 | 8.5  | 1    |   |   |   |   |  |
| AHFM-YP1003-D20-M10-L30-Z03-H                      | ●                      | 20  | 3    | 18     | M10 | 30 | 10.5 | 1    |   |   |   |   |  |
| AHFM-YP1003-D20-M10-L30-Z03-H-F                    | ●                      | 20  | 3    | 18     | M10 | 30 | 10.5 | 1    |   |   |   |   |  |
| AHFM-YP1003-D20-M10-L30-Z04-H                      | ●                      | 20  | 4    | 18     | M10 | 30 | 10.5 | 1    |   |   |   |   |  |
| AHFM-YP1003-D20-M10-L30-Z04-F                      | ●                      | 20  | 4    | 18     | M10 | 30 | 10.5 | 1    |   |   |   |   |  |
| AHFM-YP1003-D21-M10-L30-Z03-H                      | ●                      | 21  | 3    | 18     | M10 | 30 | 10.5 | 1    |   |   |   |   |  |
| AHFM-YP1003-D21-M10-L30-Z03-H-F                    | ●                      | 21  | 3    | 18     | M10 | 30 | 10.5 | 1    |   |   |   |   |  |
| AHFM-YP1003-D25-M12-L35-Z04-H                      | ●                      | 25  | 4    | 21     | M12 | 35 | 12.5 | 1    |   |   |   |   |  |
| AHFM-YP1003-D25-M12-L35-Z04-F                      | ●                      | 25  | 4    | 21     | M12 | 35 | 12.5 | 1    |   |   |   |   |  |
| AHFM-YP1003-D25-M12-L35-Z04-H-F                    | ●                      | 25  | 4    | 21     | M12 | 35 | 12.5 | 1    |   |   |   |   |  |
| AHFM-YP1003-D26-M12-L35-Z04-H-F                    | ●                      | 26  | 4    | 21     | M12 | 35 | 12.5 | 1    |   |   |   |   |  |
| AHFM-YP1003-D32-M16-L30-Z05-F                      | ●                      | 32  | 5    | 29     | M16 | 30 | 17   | 1    |   |   |   |   |  |
| AHFM-YP1003-D32-M16-L43-Z05-H-F                    | ●                      | 32  | 5    | 29     | M16 | 43 | 17   | 1    |   |   |   |   |  |
| AHFM-YP1003-D40-M16-L43-Z06-H-F                    | ●                      | 40  | 6    | 29     | M16 | 43 | 17   | 1    |   |   |   |   |  |
| AHFM-YP1003-D42-M16-L43-Z06-H-F                    | ●                      | 42  | 6    | 29     | M16 | 43 | 17   | 1    |   |   |   |   |  |

R: Sağ / Right / Rechts/ L: Sol / Left / Links

● Stokta / In Stock / Auf Lager ○ Stokta Yok / Non Stock Item / Kein Lagerartikel, Lieferzeit auf Anfrage

DJT Ucuna Uygun. / Compatible with DJT Insert. / Kompatibel mit DJT Wendepplatten.

Çap Ölçüsü - 0,02 mm Olarak üretiliyor. F: ± 0,02 mm Demektir. Ör: Ø16 Takım 15,98 ± 0,02 mm yani 16,00 mm - 15,96 mm Olmalıdır.

Diameter Size is produced as - 0.02 mm. F: means ± 0,02 mm. For example: Ø16 tool 15.98 ± 0.02 mm, it means that it should be 16.00 mm - 15.96 mm.

Durchmesser - Es wird mit -0,02 mm hergestellt. Das heißt F: ± 0,02 mm. Zum Beispiel: Der Ø16-Satz sollte 15,98 ± 0,02 mm, 16,00 mm - 15,96 mm betragen.

Sipariş Örneği/Ordering Example/Bestellbeispiel

1 ad./pcs./stück AHFM-YP1003-D16-M08-L23-Z02-F

Kesme Hesabı : S 377 / Cutting Calculation : P 377 / Schnittberechnung : P 377

Sıkma Tork Değeri : S 376 / Tightening Torque : P 376 / Anzugsmoment : P 376

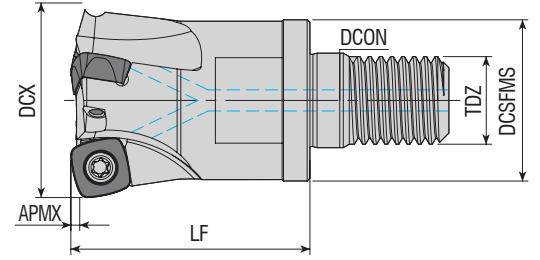

| Takım Kodu<br>Ordering Code<br>Bestell-Bezeichnung | Stok<br>Stock<br>Lager | Takım Ölçüleri (mm)<br>Dimension (mm)<br>Abmessung (mm) |      |        |     |    |      |      | Kesici Uç<br>Insert<br>Wendeschneidplatte | Yedek Parçaları / Spare Parts / Ersatzteile |   |   |  |
|--|------------------------|---|------|--------|-----|----|------|------|---|---|---|---|--|
|  |                        | DCX   | ZEFP | DCSFMS | TDZ | LF | DCON | APMX |   | Sıkma Vidası<br>Screw<br>Schraube           | Baskı Parçası<br>Wedge Clamp<br>Spannpratze | Baskı Vidası<br>Clamp Screw<br>Schraube | Tork Anahtar<br>Torx Key<br>Torx-Schlüssel |
| AHFM-SP1004-D25-M12-L35-Z02-H                      | ●                      | 25  | 2    | 21     | M12 | 35 | 12.5 | 1    | SPNW 1004..                               |   | -   | -                                       | 80-T15                                     |
| AHFM-SP1004-D32-M16-L43-Z03-H                      | ●                      | 32  | 3    | 29     | M16 | 43 | 17   | 1.5  |   |   |   |   |  |
| AHFM-SP1004-D35-M16-L43-Z03-H                      | ●                      | 35  | 3    | 29     | M16 | 43 | 17   | 1.5  |   |   |   |   |  |
| AHFM-SP1004-D42-M16-L43-Z04-H                      | ●                      | 42  | 4    | 29     | M16 | 43 | 17   | 1.5  |   |   |   |   |  |

DJT Ucuna Uygunur. / Compatible with DJT Insert. / Kompatibel mit DJT Wendeplatten.

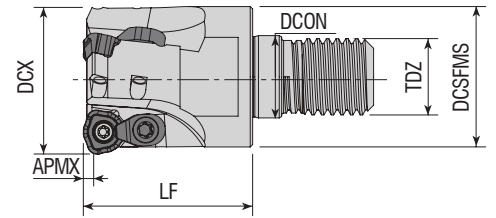

| Takım Kodu<br>Ordering Code<br>Bestell-Bezeichnung | Stok<br>Stock<br>Lager | Takım Ölçüleri (mm)<br>Dimension (mm)<br>Abmessung (mm) |      |        |     |    |      |      | Kesici Uç<br>Insert<br>Wendeschneidplatte | Yedek Parçaları / Spare Parts / Ersatzteile |   |   |  |
|--|------------------------|---|------|--------|-----|----|------|------|---|---|---|---|--|
|  |                        | DCX   | ZEFP | DCSFMS | TDZ | LF | DCON | APMX |   | Sıkma Vidası<br>Screw<br>Schraube           | Baskı Parçası<br>Wedge Clamp<br>Spannpratze | Baskı Vidası<br>Clamp Screw<br>Schraube | Tork Anahtar<br>Torx Key<br>Torx-Schlüssel |
| AHFMC-WD0804-D25-M12-L35-Z02-H                     | ●                      | 25  | 2    | 21     | M12 | 35 | 12.5 | 1.5  | WDMT 0804..                               |   | ACK-15                                      | 4010-M3x8                               | 82-T10                                     |
| AHFMC-WD0804-D32-M16-L35-Z03-H                     | ●                      | 32  | 3    | 29     | M16 | 35 | 17   | 1.5  |   |   |   |   |  |

R: Sağ / Right / Rechts/ L: Sol / Left / Links

● Stokta / In Stock / Auf Lager ○ Stokta Yok / Non Stock Item / Kein Lagerartikel, Lieferzeit auf Anfrage  
SMTM Ucuna Uygunur. / Compatible with SMTM Insert. / Kompatibel mit SMTM Wendeplatten.

Sipariş Örneği/Ordering Example/Bestellbeispiel

1 ad./pcs./stück AHFM-SP1004-D25-M12-L35-Z02-H

Kesme Hesabı : S 377 / Cutting Calculation : P 377 / Schnittberechnung : P 377

Sıkma Tork Değeri : S 376 / Tightening Torque : P 376 / Anzugsmoment : P 376

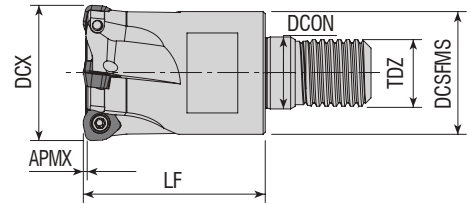

| Takım Kodu<br>Ordering Code<br>Bestell-Bezeichnung | Stok<br>Stock<br>Lager | Takım Ölçüleri (mm)<br>Dimension (mm)<br>Abmessung (mm) |      |        |     |    |      |      | Kesici Uç<br>Insert<br>Wendeschneidplatte | Yedek Parçaları / Spare Parts / Ersatzteile |   |   |  |
|--|------------------------|---|------|--------|-----|----|------|------|---|---|---|---|--|
|  |                        | DCX   | ZEFP | DCSFMS | TDZ | LF | DCON | APMX |   | Sıkma Vidası<br>Screw<br>Schraube           | Baskı Parçası<br>Wedge Clamp<br>Spannpratze | Baskı Vidası<br>Clamp Screw<br>Schraube | Tork Anahtar<br>Torx Key<br>Torx-Schlüssel |
| AHFM-WD0503D-D20-M10-L30-Z02-H                     | ●                      | 20  | 2    | 18     | M10 | 30 | 10.5 | 1.25 | WDMT 0503..                               | 4010-M3x6                                   |   |   |  |
| AHFM-WD0503D-D25-M12-L35-Z03-H                     | ●                      | 25  | 3    | 21     | M12 | 35 | 12.5 | 1.25 |   | 4010-M3x8                                   | -   | -                                       | 82-T10                                     |
| AHFM-WD0503D-D32-M16-L43-Z04-H                     | ●                      | 32  | 4    | 29     | M16 | 43 | 17   | 1.25 |   |   |   |   |  |
| AHFM-WD0503D-D40-M16-L43-Z05-H                     | ●                      | 40  | 5    | 29     | M16 | 43 | 17   | 1.25 |   |   |   |   |  |
| AHFMC-WD06T3D-D35-M16-L43-Z03-H                    | ●                      | 35  | 3    | 29     | M16 | 43 | 17   | 1.5  | WDHW 06T3..                               | 3015-M3.5x9                                 | ACK-15                                      | 4015-M3.5x11                            | 80-T15                                     |
| AHFMC-WD0805D-D32-M16-L43-Z02-H                    | ●                      | 32  | 2    | 29     | M16 | 43 | 17   | 2    | WDHW 0805..                               | 4020-M4.5x10                                | ACK-19                                      | 4020-M4.5x12                            |  |

DJT Ucuna Uygun. / Compatible with DJT Insert. / Kompatibel mit DJT Wendeplatten.

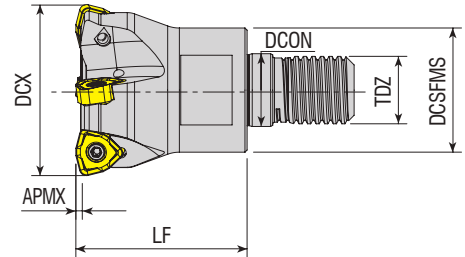

| Takım Kodu<br>Ordering Code<br>Bestell-Bezeichnung | Stok<br>Stock<br>Lager | Takım Ölçüleri (mm)<br>Dimension (mm)<br>Abmessung (mm) |      |        |     |    |      |      | Kesici Uç<br>Insert<br>Wendeschneidplatte | Yedek Parçaları / Spare Parts / Ersatzteile |  |  |
|--|------------------------|---|------|--------|-----|----|------|------|---|---|--|--|
|  |                        | DCX   | ZEFP | DCSFMS | TDZ | LF | DCON | APMX |   | Sıkma Vidası<br>Screw<br>Schraube           | Tork Anahtar<br>Torx Key<br>Torx-Schlüssel |  |
| AHFM-WN09T3-D32-M16-L40-Z03-H                      | ●                      | 32  | 3    | 29     | M16 | 40 | 17   | 1.5  | WNMX 09T3..                               | 4010-M3x8                                   | 82-T10                                     |  |
| new AHFM-WN09T3-D35-M16-L40-Z04-H                  | ●                      | 35  | 4    | 26     | M16 | 40 | 17   | 1.5  |   |   |  |  |
| AHFM-WN09T3-D40-M16-L40-Z04-H                      | ●                      | 40  | 4    | 29     | M16 | 40 | 17   | 1.5  |   |   |  |  |

R: Sağ / Right / Rechtsl L: Sol / Left / Links

● Stokta / In Stock / Auf Lager ○ Stokta Yok / Non Stock Item / Kein Lagerartikel, Lieferzeit auf Anfrage

KRLY Ucuna Uygun. / Compatible with KRLY Insert. / Kompatibel mit KRLY Wendeplatten.

Sipariş Örneği/Ordering Example/Bestellbeispiel

1 ad./pcs./stück AHFM-WD0503D-D20-M10-L30-Z02-H

Kesme Hesabı : S 377 / Cutting Calculation : P 377 / Schnittberechnung : P 377

Sıkma Tork Değeri : S 376 / Tightening Torque : P 376 / Anzugsmoment : P 376

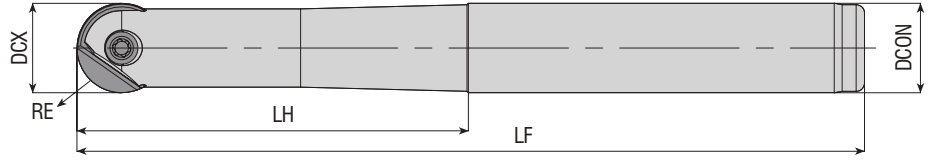

| Takım Kodu<br>Ordering Code<br>Bestell-Bezeichnung | Stok<br>Stock<br>Lager | Takım Ölçüleri (mm)<br>Dimension (mm)<br>Abmessung (mm) |      |      |     |     | Kesici Uç<br>Insert<br>Wendeschneidplatte | Yedek Parçaları / Spare Parts / Ersatzteile |  |
|--|------------------------|---|------|------|-----|-----|---|---|--|
|  |                        | DCX   | RE   | DCON | LF  | LH  |   | Sıkma Vidası<br>Screw<br>Schraube           | Tork Anahtar<br>Torx Key<br>Torx-Schlüssel |
| APMR-BNM12-D12-C12-L130                            | ●                      | 12  | 6    | 12   | 130 | 32  |   |   |  |
| APMR-BNM16-D16-C16-L175                            | ●                      | 16  | 8    | 16   | 175 | 70  |   |   |  |
| APMR-BNM16-D16-C16-L200                            | ●                      | 16  | 8    | 16   | 200 | 100 |   |   |  |
| APMR-BNM20-D20-C20-L160                            | ●                      | 20  | 10   | 20   | 160 | 70  |   |   |  |
| APMR-BNM20-D20-C20-L200                            | ●                      | 20  | 10   | 20   | 200 | 100 |   |   |  |
| APMR-BNM20-D20-C20-L250                            | ●                      | 20  | 10   | 20   | 250 | 150 |   |   |  |
| APMR-BNM25-D25-C25-L160                            | ●                      | 25  | 12.5 | 25   | 160 | 70  |   |   |  |
| APMR-BNM25-D25-C25-L200                            | ●                      | 25  | 12.5 | 25   | 200 | 100 |   |   |  |
| APMR-BNM25-D25-C25-L250                            | ●                      | 25  | 12.5 | 25   | 250 | 150 |   |   |  |

DJT Ucuna Uygundur. / Compatible with DJT Insert. / Kompatibel mit DJT Wendepfatten.

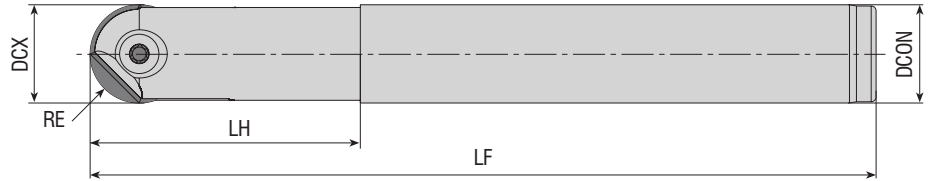

| Takım Kodu<br>Ordering Code<br>Bestell-Bezeichnung | Stok<br>Stock<br>Lager | Takım Ölçüleri (mm)<br>Dimension (mm)<br>Abmessung (mm) |    |      |     |    | Kesici Uç<br>Insert<br>Wendeschneidplatte | Yedek Parçaları / Spare Parts / Ersatzteile |  |
|--|------------------------|---|----|------|-----|----|---|---|--|
|  |                        | DCX   | RE | DCON | LF  | LH |   | Sıkma Vidası<br>Screw<br>Schraube           | Tork Anahtar<br>Torx Key<br>Torx-Schlüssel |
| APMR-RO12-D12-C12-L120                             | ●                      | 12  | 6  | 12   | 120 | 35 |   |   |  |
| APMR-RO12-D12-C16-L160                             | ●                      | 12  | 6  | 16   | 160 | 50 |   |   |  |
| APMR-RO16-D16-C16-L160                             | ●                      | 16  | 8  | 16   | 160 | 45 |   |   |  |
| APMR-RO16-D16-C16-L200                             | ●                      | 16  | 8  | 16   | 200 | 45 |   |   |  |
| APMR-RO16-D16-C20-L200                             | ●                      | 16  | 8  | 20   | 200 | 65 |   |   |  |
| APMR-RO20-D20-C20-L160                             | ●                      | 20  | 10 | 20   | 160 | 55 |   |   |  |
| APMR-RO20-D20-C20-L200                             | ●                      | 20  | 10 | 20   | 200 | 55 |   |   |  |
| APMR-RO20-D20-C25-L220                             | ●                      | 20  | 10 | 25   | 220 | 80 |   |   |  |

R: Sağ / Right / Rechts/ L: Sol / Left / Links

● Stokta / In Stock / Auf Lager ○ Stokta Yok / Non Stock Item / Kein Lagerartikel, Lieferzeit auf Anfrage

ZCC Ucuna Uygundur. / Compatible with ZCC Insert. / Kompatibel mit ZCC Wendepfatten.

Sipariş Örneği/Ordering Example/Bestellbeispiel

1 ad./pcs./stück APMR-BNM12-D12-C12-L130

Kesme Hesabı : S 377/ Cutting Calculation : P 377 / Schnittberechnung : P 377



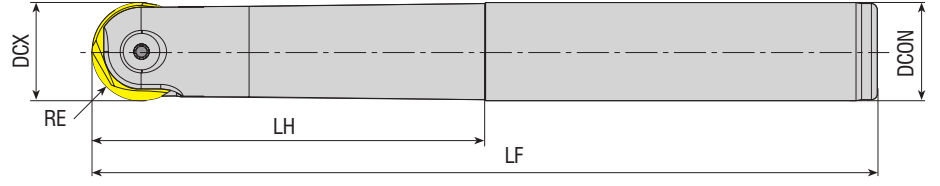

| Takım Kodu<br>Ordering Code<br>Bestell-Bezeichnung | Stok<br>Stock<br>Lager | Takım Ölçüleri (mm)<br>Dimension (mm)<br>Abmessung (mm) |      |      |     |     | Kesici Uç<br>Insert<br>Wendeschneidplatte | Yedek Parçaları / Spare Parts / Ersatzteile |  |
|--|------------------------|---|------|------|-----|-----|---|---|--|
|  |                        | DCX   | RE   | DCON | LF  | LH  |   | Sıkma Vidası<br>Screw<br>Schraube           | Tork Anahtar<br>Torx Key<br>Torx-Schlüssel |
| APMR-P3208-D08-C10-L110                            | ●                      | 8   | 4    | 10   | 110 | 25  |   |   |  |
| APMR-P3210-D10-C10-L130                            | ●                      | 10  | 5    | 10   | 130 | 30  |   |   |  |
| APMR-P3210-D10-C12-L130                            | ●                      | 10  | 5    | 12   | 130 | 30  |   |   |  |
| APMR-P3212-D12-C12-L130                            | ●                      | 12  | 6    | 12   | 130 | 32  |   |   |  |
| APMR-P3216-D16-C16-L175                            | ●                      | 16  | 8    | 16   | 175 | 75  |   |   |  |
| APMR-P3220-D20-C20-L200                            | ●                      | 20  | 10   | 20   | 200 | 100 |   |   |  |
| APMR-P3225-D25-C25-L200                            | ●                      | 25  | 12.5 | 25   | 200 | 100 |   |   |  |
| APMR-P3232-D32-C32-L200                            | ●                      | 32  | 16   | 32   | 200 | 100 |   |   |  |

WLTR Ucuna Uygun. / Compatible with WLTR Insert. / Kompatibel mit WLTR Wendeplatten.

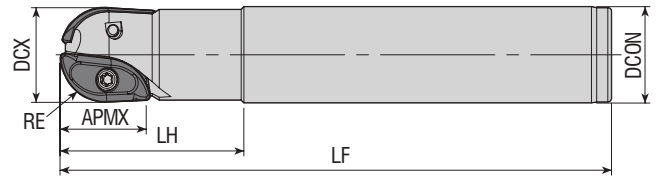

| Takım Kodu<br>Ordering Code<br>Bestell-Bezeichnung | Stok<br>Stock<br>Lager | Takım Ölçüleri (mm)<br>Dimension (mm)<br>Abmessung (mm) |      |      |     |    |      | Kesici Uç<br>Insert<br>Wendeschneidplatte | Yedek Parçaları / Spare Parts / Ersatzteile |  |
|--|------------------------|---|------|------|-----|----|------|---|---|--|
|  |                        | DCX   | RE   | DCON | LF  | LH | APMX |   | Sıkma Vidası<br>Screw<br>Schraube           | Tork Anahtar<br>Torx Key<br>Torx-Schlüssel |
| APMR-XP16-D16-C16-L150                             | ●                      | 16  | 8    | 16   | 150 | 40 | 16   |   |   |  |
| APMR-XP20-D20-C20-L150                             | ●                      | 20  | 10   | 20   | 150 | 50 | 20   |   |   |  |
| APMR-XP25-D25-C25-L150                             | ●                      | 25  | 12.5 | 25   | 150 | 50 | 25   |   |   |  |

R: Sağ / Right / Rechts/ L: Sol / Left / Links

● Stokta / In Stock / Auf Lager ○ Stokta Yok / Non Stock Item / Kein Lagerartikel, Lieferzeit auf Anfrage

ZCC Ucuna Uygun. / Compatible with ZCC Insert. / Kompatibel mit ZCC Wendeplatten.

Sipariş Örneği/Ordering Example/Bestellbeispiel

1 ad./pcs./stück APMR-P3208-D08-C10-L110

Kesme Hesabı : S 377/ Cutting Calculation : P 377 / Schnittberechnung : P 377

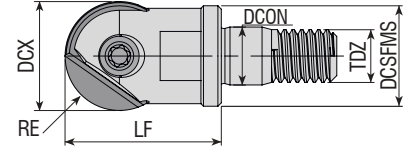

| Takım Kodu<br>Ordering Code<br>Bestell-Bezeichnung | Stok<br>Stock<br>Lager | Takım Ölçüleri (mm)<br>Dimension (mm)<br>Abmessung (mm) |    |        |     |    |      | Kesici Uç<br>Insert<br>Wendeschneidplatte | Yedek Parçaları / Spare Parts / Ersatzteile |  |  |
|--|------------------------|---|----|--------|-----|----|------|---|---|--|--|
|  |                        | DCX   | RE | DCSFMS | TDZ | LF | DCON |   | Sıkma Vidası<br>Screw<br>Schraube           | Tork Anahtar<br>Torx Key<br>Torx-Schlüssel |  |
| APMR-BNM12-D12-M06-L20                             | ●                      | 12  | 6  | 11     | M06 | 20 | 6.5  |   |   |  |  |
| APMR-BNM16-D16-M08-L23                             | ●                      | 16  | 8  | 14.75  | M08 | 23 | 8.5  | <b>BNM 120-S</b>                          | 1210-M3.5x9.6                               | 82-T10                                     |  |
| APMR-BNM20-D20-M10-L30                             | ●                      | 20  | 10 | 18     | M10 | 30 | 10.5 | <b>BNM 160-S</b>                          | 1215-M4x13.5                                | 80-T15                                     |  |
|  |                        |   |    |        |     |    |      | <b>BNM 200-S</b>                          | 1220-M5x0.5x15                              | 80-T20                                     |  |

DJT Ucuna Uygunur. / Compatible with DJT Insert. / Kompatibel mit DJT Wendeplatten.

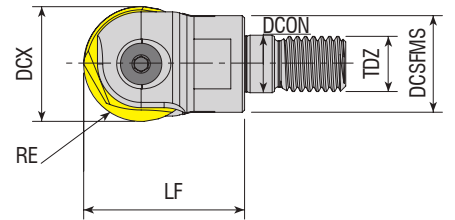

| Takım Kodu<br>Ordering Code<br>Bestell-Bezeichnung | Stok<br>Stock<br>Lager | Takım Ölçüleri (mm)<br>Dimension (mm)<br>Abmessung (mm) |      |        |     |    |      | Kesici Uç<br>Insert<br>Wendeschneidplatte | Yedek Parçaları / Spare Parts / Ersatzteile |  |  |
|--|------------------------|---|------|--------|-----|----|------|---|---|--|--|
|  |                        | DCX   | RE   | DCSFMS | TDZ | LF | DCON |   | Sıkma Vidası<br>Screw<br>Schraube           | Tork Anahtar<br>Torx Key<br>Torx-Schlüssel |  |
| APMR-P3216-D16-M08-L25                             | ●                      | 16  | 8    | 14     | M08 | 25 | 8.5  |   |   |  |  |
| APMR-P3220-D20-M10-L30                             | ●                      | 20  | 10   | 18     | M10 | 30 | 10.5 | <b>P3216</b>                              | 1220-M5x0.5x12                              | 80-T20                                     |  |
| APMR-P3225-D25-M12-L35                             | ●                      | 25  | 12.5 | 21     | M12 | 35 | 12.5 | <b>P3220</b>                              | 1220-M5x0.5x15                              |  |  |
| APMR-P3232-D32-M16-L43                             | ●                      | 32  | 16   | 30     | M16 | 43 | 17   | <b>P3225</b>                              | 1220-M6x0.75x20                             | AAL-05-4                                   |  |
|  |                        |   |      |        |     |    |      | <b>P3232</b>                              | 1204-M8x0.75x26                             |  |  |

R: Sağ / Right / Rechts L: Sol / Left / Links

● Stokta / In Stock / Auf Lager ○ Stokta Yok / Non Stock Item / Kein Lagerartikel, Lieferzeit auf Anfrage

WLTR Ucuna Uygunur. / Compatible with WLTR Insert. / Kompatibel mit WLTR Wendeplatten.



Sipariş Örneği/Ordering Example/Bestellbeispiel

1 ad./pcs./stück APMR-BNM12-D12-M06-L20

Kesme Hesabı : S 377 / Cutting Calculation : P 377 / Schnittberechnung : P 377

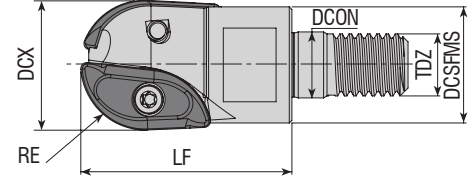
Sıkma Tork Değeri : S 376 / Tightening Torque : P 376 / Anzugsmoment : P 376

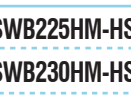

| Takım Kodu<br>Ordering Code<br>Bestell-Bezeichnung | Stok<br>Stock<br>Lager | Takım Ölçüleri (mm)<br>Dimension (mm)<br>Abmessung (mm) |      |        |     |    |      | Kesici Uç<br>Insert<br>Wendeschneidplatte  | Yedek Parçaları / Spare Parts / Ersatzteile |  |  |
|--|------------------------|---|------|--------|-----|----|------|--|---|--|--|
|  |                        | DCX   | RE   | DCSFMS | TDZ | LF | DCON |  | Sıkma Vidası<br>Screw<br>Schraube           | Tork Anahtar<br>Torx Key<br>Torx-Schlüssel |  |
| APMR-SWB225-D25-M12-L35                            | ●                      | 25  | 12.5 | 23.5   | M12 | 35 | 12.5 | <br><br> | 4015-M4x9                                   | 80-T15                                     |  |
| APMR-SWB230-D30-M16-L43                            | ●                      | 30  | 15   | 28     | M16 | 43 | 17   |  | 1020-M5x11                                  | 80-T20                                     |  |
| APMR-SWB232-D32-M16-L43                            | ●                      | 32  | 16   | 30     | M16 | 43 | 17   |  |   |  |  |

DJT Ucuna Uygunur. / Compatible with DJT Insert. / Kompatibel mit DJT Wendeplatten.

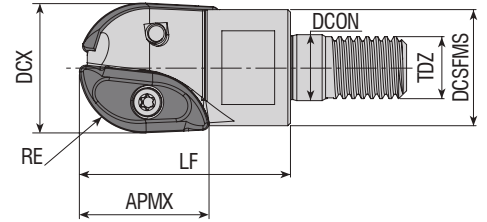

| Takım Kodu<br>Ordering Code<br>Bestell-Bezeichnung | Stok<br>Stock<br>Lager | Takım Ölçüleri (mm)<br>Dimension (mm)<br>Abmessung (mm) |      |        |     |    |      |      | Kesici Uç<br>Insert<br>Wendeschneidplatte  | Yedek Parçaları / Spare Parts / Ersatzteile |  |  |
|--|------------------------|---|------|--------|-----|----|------|------|--|---|--|--|
|  |                        | DCX   | RE   | DCSFMS | TDZ | LF | APMX | DCON |  | Sıkma Vidası<br>Screw<br>Schraube           | Tork Anahtar<br>Torx Key<br>Torx-Schlüssel |  |
| APMR-XP16-D16-M08-L25                              | ●                      | 16  | 8    | 14.75  | M08 | 25 | 16   | 8.5  |  | 3008-M2.5x6                                 | 82-T08                                     |  |
| APMR-XP20-D20-M10-L30                              | ●                      | 20  | 10   | 18     | M10 | 30 | 20   | 10.5 |  | 3010-M3.5x7                                 | 82-T10                                     |  |
| APMR-XP25-D25-M12-L40                              | ●                      | 25  | 12.5 | 22     | M12 | 40 | 25   | 12.5 |  | 4015-M4x9                                   | 80-T15                                     |  |

R: Sağ / Right / Rechts/ L: Sol / Left / Links

● Stokta / In Stock / Auf Lager ○ Stokta Yok / Non Stock Item / Kein Lagerartikel, Lieferzeit auf Anfrage  
ZCC Ucuna Uygunur. / Compatible with ZCC Insert. / Kompatibel mit ZCC Wendeplatten.

Sipariş Örneği/Ordering Example/Bestellbeispiel

1 ad./pcs./stück APMR-SWB225-D25-M12-L35

Kesme Hesabı : S 377 / Cutting Calculation : P 377 / Schnittberechnung : P 377

Sıkma Tork Değeri : S 376 / Tightening Torque : P 376 / Anzugsmoment : P 376

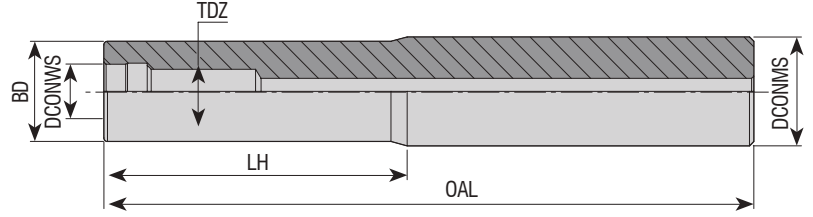

| Takım Kodu<br>Ordering Code<br>Bestell-Bezeichnung | Stok<br>Stock<br>Lager | Takım Ölçüleri (mm)<br>Dimension (mm)<br>Abmessung (mm) |     |        |    |     |     |
|--|------------------------|---|-----|--------|----|-----|-----|
|  |                        | DCONMS  | TDZ | DCONWS | BD | OAL | LH  |
| AVTT-D13-C16-M08-L100-H                            | ●                      | 16  | M08 | 8.5    | 13 | 100 | 40  |
| AVTT-D15-C16-M08-L130-H                            | ●                      | 16  | M08 | 8.5    | 15 | 130 | 70  |
| AVTT-D18-C20-M10-L130-H                            | ●                      | 20  | M10 | 10.5   | 18 | 130 | 70  |
| AVTT-D18-C20-M10-L160-H                            | ●                      | 20  | M10 | 10.5   | 18 | 160 | 80  |
| AVTT-D23-C25-M12-L150-H                            | ●                      | 25  | M12 | 12.5   | 23 | 150 | 70  |
| AVTT-D23-C25-M12-L200-H                            | ●                      | 25  | M12 | 12.5   | 23 | 200 | 100 |
| AVTT-D23-C25-M12-L250-H                            | ●                      | 25  | M12 | 12.5   | 23 | 250 | 150 |
| AVTT-D30-C32-M16-L150-H                            | ●                      | 32  | M16 | 17     | 30 | 150 | 70  |
| AVTT-D30-C32-M16-L200-H                            | ●                      | 32  | M16 | 17     | 30 | 200 | 100 |
| AVTT-D30-C32-M16-L250-H                            | ●                      | 32  | M16 | 17     | 30 | 250 | 150 |
| AVTT-D30-C32-M16-L300-H                            | ●                      | 32  | M16 | 17     | 30 | 300 | 200 |

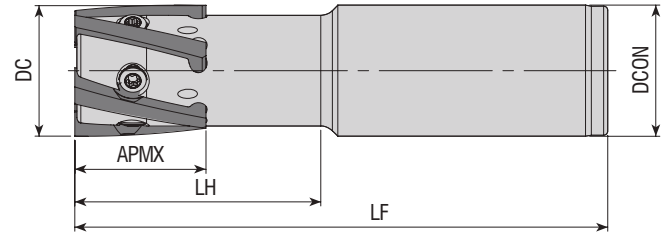

| Takım Kodu<br>Ordering Code<br>Bestell-Bezeichnung | Stok<br>Stock<br>Lager | Takım Ölçüleri (mm)<br>Dimension (mm)<br>Abmessung (mm) |      |      |     |    |      | Kesici Uç<br>Insert<br>Wendeschneidplatte | Yedek Parçaları / Spare Parts / Ersatzteile |  |
|--|------------------------|---|------|------|-----|----|------|---|---|--|
|  |                        | DC  | ZEFP | DCON | LF  | LH | APMX |   | Sıkma Vidası<br>Screw<br>Schraube           | Tork Anahtar<br>Torx Key<br>Torx-Schlüssel |
| ATM-H23-D23-C25-L100-Z02-H                         | ●                      | 23  | 2    | 25   | 100 | 30 | 27   | H23                                       | 1015-M4x8                                   | 80-T15                                     |
| ATM-H32-D32-C32-L130-Z05-H                         | ●                      | 32  | 5    | 32   | 130 | 35 | 32   | H32                                       | 1720-U8-32x10                               | 80-T20                                     |

R: Sağ / Right / Rechts/ L: Sol / Left / Links

● Stokta / In Stock / Auf Lager ○ Stokta Yok / Non Stock Item / Kein Lagerartikel, Lieferzeit auf Anfrage

CPT Ucuna Uygun / Compatible with CPT Insert. / Kompatibel mit CPT Wendeplatten.

Sipariş Örneği/Ordering Example/Bestellbeispiel

1 ad./pcs./stück AVTT-D13-C16-M08-L100-H

Kesme Hesabı : S 377/ Cutting Calculation : P 377 / Schnittberechnung : P 377

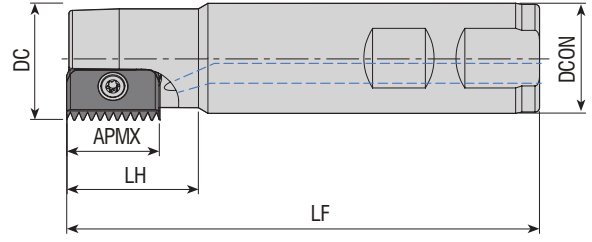

| Takım Kodu<br>Ordering Code<br>Bestell-Bezeichnung | Stok<br>Stock<br>Lager | Takım Ölçüleri (mm)<br>Dimension (mm)<br>Abmessung (mm) |      |      |     |    |      | Kesici Uç<br>Insert<br>Wendeschneidplatte | Yedek Parçaları / Spare Parts / Ersatzteile |  |        |
|--|------------------------|---|------|------|-----|----|------|---|---|--|--------|
|  |                        | DC  | ZAFP | DCON | LF  | LH | APMX |   | Sıkma Vidası<br>Screw<br>Schraube           | Tork Anahtar<br>Torx Key<br>Torx-Schlüssel |        |
| ATM-C14-D14-W20-L100-Z01-H                         | ●                      | 14  | 1    | 20   | 100 | 25 | 14   | <b>C14</b>                                | 3008-M2.5x6<br>4015-M4x9                    | 82-T08                                     |        |
| ATM-C21-D18-W20-L100-Z01-H                         | ●                      | 18  | 1    | 20   | 100 | 30 | 21   |   |   |  |        |
| ATM-C21-D21-W25-L125-Z01-H                         | ●                      | 21  | 1    | 25   | 125 | 40 | 21   |   | <b>C21</b>                                  | 4015-M4x11                                 | 80-T15 |
| ATM-C21-D25-W20-L125-Z01-H                         | ●                      | 25  | 1    | 20   | 125 | 30 | 21   |   |   |  |        |
| ATM-C21-D28-W25-L90-Z01-H                          | ●                      | 28  | 1    | 25   | 90  | 30 | 21   |   |   |  |        |
| ATM-C21-D38-W32-L90-Z03-H                          | ●                      | 38  | 3    | 32   | 90  | 30 | 21   |   |   |  |        |
| ATM-C21-D38-W32-L120-Z03-H                         | ●                      | 38  | 3    | 32   | 120 | 30 | 21   | <b>C30</b>                                | 1020-M5x14                                  | 80-T20                                     |        |
| ATM-C21-D43-W32-L90-Z03-H                          | ●                      | 43  | 3    | 32   | 90  | 30 | 21   |   |   |  |        |
| ATM-C30-D29-W25-L150-Z01-H                         | ●                      | 29  | 1    | 25   | 150 | 50 | 30   |   |   |  |        |

CPT Ucuna Uygunur. / Compatible with CPT Insert. / Kompatibel mit CPT Wendeplatten.

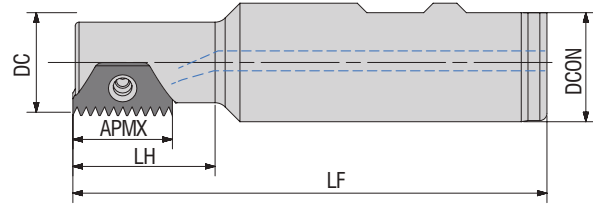



| Takım Kodu<br>Ordering Code<br>Bestell-Bezeichnung | Stok<br>Stock<br>Lager | Takım Ölçüleri (mm)<br>Dimension (mm)<br>Abmessung (mm) |      |      |     |    |      | Kesici Uç<br>Insert<br>Wendeschneidplatte | Yedek Parçaları / Spare Parts / Ersatzteile |  |  |
|--|------------------------|---|------|------|-----|----|------|---|---|--|--|
|  |                        | DC  | ZAFP | DCON | LF  | LH | APMX |   | Sıkma Vidası<br>Screw<br>Schraube           | Tork Anahtar<br>Torx Key<br>Torx-Schlüssel |  |
| ATM-3BEI-D21-W25-L100-Z01-H                        | ●                      | 21  | 1    | 25   | 100 | 30 | 21   | <b>3BEI..</b>                             | 1710-U5-40x8.8                              | 82-T10                                     |  |
| ATM-3EI-D14-W20-L90-Z01-H                          | ●                      | 14  | 1    | 20   | 90  | 22 | 15.3 |   |   |  |  |
| ATM-3EI-D20-W25-L120-Z01-H                         | ●                      | 20  | 1    | 25   | 120 | 25 | 15.3 | <b>3E../3I..</b>                          | 1710-U5-40x7.2                              |  |  |

VRGS Ucuna Uygunur. / Compatible with VRGS Insert. / Kompatibel mit VRGS Wendeplatten.

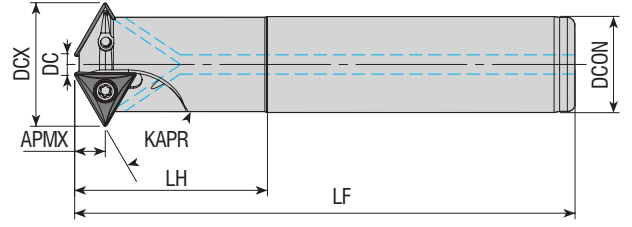

Sipariş Örneği/Ordering Example/Bestellbeispiel  
1 ad./pcs./stück ATM-C14-D14-W20-L100-Z01-H  
Kesme Hesabı : S 377 / Cutting Calculation : P 377 / Schnittberechnung : P 377

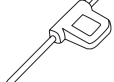

| Takım Kodu<br>Ordering Code<br>Bestell-Bezeichnung | Stok<br>Stock<br>Lager | Takım Ölçüleri (mm)<br>Dimension (mm)<br>Abmessung (mm) |      |      |      |     |    |      | Kesici Uç<br>Insert<br>Wendeschneidplatte | Yedek Parçaları / Spare Parts / Ersatzteile   |   |   |
|--|------------------------|---|------|------|------|-----|----|------|---|---|---|---|
|  |                        | KAPR  | DCX  | DCON | DC   | LF  | LH | ZEPF |   | APMX  | Sıkma Vidası<br>Screw<br>Schraube   | Tork Anahtar<br>Torx Key<br>Torx-Schlüssel  |
| ATM60-TB0601-D13-C10-L150-Z02-H                    | ●                      | 60  | 13   | 10   | 2.5  | 150 | 40 | 2    | 3.3                                       |  |  |  |
| ATM60-TC0902-D20.5-C16-L150-Z02-H                  | ●                      | 60  | 20.5 | 16   | 5.2  | 150 | 40 | 2    | 4.7                                       | <b>TBGT 060102</b>  | 3006-M2x4   | 82-T06  |
| ATM60-TC1102-D26-C20-L150-Z03-H                    | ●                      | 60  | 26   | 20   | 8.3  | 150 | 50 | 3    | 5.4                                       | <b>TC.T 090202</b>  | 3007-M2.2x4.6   | 82-T07  |
| ATM60-TC16T3-D32-C25-L150-Z02-H                    | ●                      | 60  | 32   | 25   | 6.4  | 150 | 50 | 2    | 8   | <b>TC.T 110202</b>  | 3008-M2.5x6   | 82-T08  |
| ATM60-TC16T3-D40-C32-L250-Z03-H                    | ●                      | 60  | 40   | 32   | 13.7 | 250 | 50 | 3    | 8   | <b>TC.T 16T304</b>  | 4015-M3.5x9   | 80-T15  |

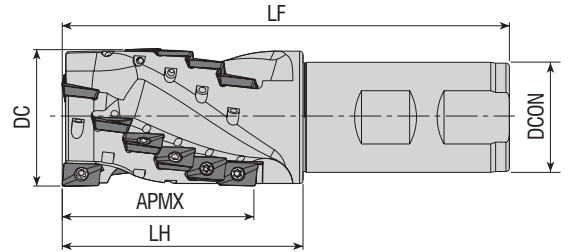
ISO Ucuna Uygun. / Compatible with ISO Insert. / Kompatibel mit ISO Wendeplatten.



| Takım Kodu<br>Ordering Code<br>Bestell-Bezeichnung | Stok<br>Stock<br>Lager | Takım Ölçüleri (mm)<br>Dimension (mm)<br>Abmessung (mm) |                                 |    |      |      |    |     | Kesici Uç<br>Insert<br>Wendeschneidplatte | Yedek Parçaları / Spare Parts / Ersatzteile   |   |   |
|--|------------------------|---|---------------------------------|----|------|------|----|-----|---|---|---|---|
|  |                        | ZEFP  |                                 | DC | DCON | APMX | LH | LF  |   |  |  |  |
|  |                        | Toplam<br>Total<br>Gesamt                               | Etkili<br>Effective<br>Effektiv |    |      |      |    |     |   |   |   |   |
| AHM90-AP10-D20-W20-L087-Z0204                      | ●                      | 4   | 2                               | 20 | 20   | 28   | 37 | 87  | <b>AP. 1003..</b>                         | 3008-M2.5x6   | 82-T08  |   |
| AHM90-AP10-D20-W20-L087-Z0206                      | ●                      | 6   | 2                               | 20 | 20   | 28   | 37 | 87  |   |   |   |   |
| AHM90-AP10-D25-W25-L105-Z0208-H                    | ●                      | 8   | 2                               | 25 | 25   | 37   | 50 | 105 |   |   |   |   |
| AHM90-AP10-D32-W32-L115-Z0315-H                    | ●                      | 15  | 3                               | 32 | 32   | 46   | 55 | 115 |   |   |   |   |
| AHM90-AP10-D40-W32-L130-Z0318-H                    | ●                      | 18  | 3                               | 40 | 32   | 55   | 70 | 130 |   |   |   |   |

ISO Ucuna Uygun. / Compatible with ISO Insert. / Kompatibel mit ISO Wendeplatten.

Sipariş Örneği/Ordering Example/Bestellbeispiel

1 ad./pcs./stück ATM60-TB0601-D13-C10-L150-Z02-H  
Kesme Hesabı : S 377/ Cutting Calculation : P 377 / Schnittberechnung : P 377

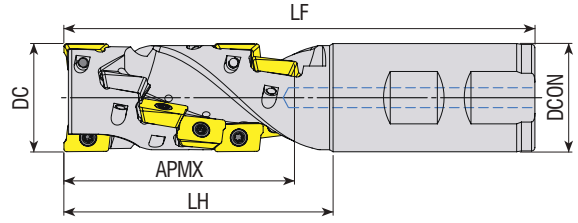

**Takım Kodu**  
**Ordering Code**  
*Bestell-Bezeichnung*

Stok  
Stock  
Lager

Takım Ölçüleri (mm)  
Dimension (mm)  
Abmessung (mm)

Kesici Uç  
Insert  
Wendeschneidplatte

Yedek Parçaları / Spare Parts / Ersatzteile

Sıkma Vidası  
Screw  
Schraube

Tork Anahtar  
Torx Key  
Torx-Schlüssel

ZEFP  
Toplam  
Total  
Gesamt

Etkili  
Effective  
Effektiv

DC

DCON

APMX

LH

LF



AHM90-AP1204-D32-W32-L140-Z0212-H

AHM90-AP1204-D40-W32-L160-Z0321-H

●

●

12

21

2

3

32

40

32

32

68

79

80

100

140

160

AP. 1204..

3010-M3.5x9

82-T10

R: Sağ / Right / Rechts L: Sol / Left / Links

● Stokta / In Stock / Auf Lager ○ Stokta Yok / Non Stock Item / Kein Lagerartikel, Lieferzeit auf Anfrage

TGTC Ucuna Uygundur. / Compatible with TGTC Insert. / Kompatibel mit TGTC Wendeplatten.

Sipariş Örneği/Ordering Example/Bestellbeispiel

1 ad./pcs./stück AHM90-AP1204-D32-W32-L140-Z0212-H

Kesme Hesabı : S 377/ Cutting Calculation : P 377 / Schnittberechnung : P 377



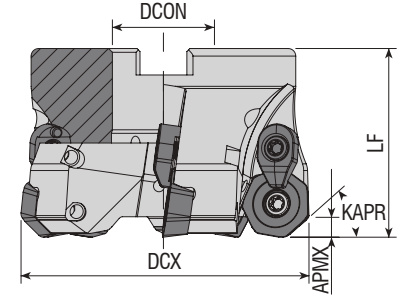

| Takım Kodu<br>Ordering Code<br>Bestell-Bezeichnung | Stok<br>Stock<br>Lager | Takım Ölçüleri (mm)<br>Dimension (mm)<br>Abmessung (mm) |      |      |    |      | Kesici Uç<br>Insert<br>Wendeschneidplatte | Yedek Parçaları / Spare Parts / Ersatzteile |   |  |  |   |
|--|------------------------|---|------|------|----|------|---|---|---|--|--|---|
|  |                        | DCX   | ZEPF | DCON | LF | APMX |   | Sıkma Vidası<br>Screw<br>Schraube           | Baskı Parçası<br>Wedge Clamp<br>Spannpratze | Baskı Vidası<br>Clamp Screw<br>Klemmschraube | Tork Anahtar<br>Torx Key<br>Torx-Schlüssel | Montaj Vidası<br>Mounting Screw<br>Befestigungsschraube |
| AFM42C-XD0806-D063-A27-Z04-H                       | ●                      | 63  | 4    | 27   | 50 | 12   | XDMW 0806..                               | 4020-M4.5x12                                | ACK-24                                      | 4020-M4.5x12                                 | 80-T20                                     | 2510-M12x35   |
| AFM42C-XD0806-D080-A27-Z05-H                       | ●                      | 80  | 5    | 27   | 50 | 12   |   |   |   |  |  |   |
| AFM42C-XD0806-D100-A32-Z06-H                       | ●                      | 100   | 6    | 32   | 63 | 12   |   |   |   |  |  |   |
| AFM42C-XD0806-D125-B40-Z07                         | ●                      | 125   | 7    | 40   | 63 | 12   |   |   |   |  |  |   |
| AFM42C-XD0806-D160-C40-Z08                         | ●                      | 160   | 8    | 40   | 63 | 12   |   |   |   |  |  |   |
| AFM42C-XD0806-D200-C60-Z09                         | ●                      | 200   | 9    | 60   | 63 | 12   |   |   |   |  |  |   |

DJT Ucuna Uygun. / Compatible with DJT Insert. / Kompatibel mit DJT

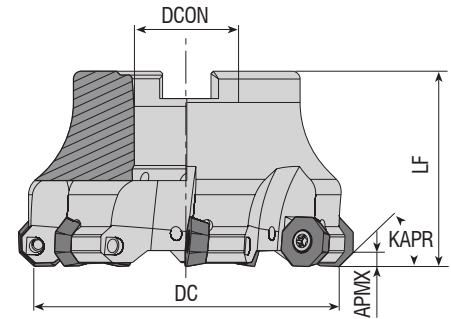

| Takım Kodu<br>Ordering Code<br>Bestell-Bezeichnung | Stok<br>Stock<br>Lager | Takım Ölçüleri (mm)<br>Dimension (mm)<br>Abmessung (mm) |      |      |    |      | Kesici Uç<br>Insert<br>Wendeschneidplatte | Yedek Parçaları / Spare Parts / Ersatzteile |  |   |  |
|--|------------------------|---|------|------|----|------|---|---|--|---|--|
|  |                        | DC  | ZEPF | DCON | LF | APMX |   | Sıkma Vidası<br>Screw<br>Schraube           | Tork Anahtar<br>Torx Key<br>Torx-Schlüssel | Montaj Vidası<br>Mounting Screw<br>Befestigungsschraube |  |
| AFM43-OD0504-D040-A16-Z04-H                        | ●                      | 40  | 4    | 16   | 40 | 3.5  | OD.. 0504..                               | 4015-M3.5x11                                | 80-T15                                     | 2510-M12x35   |  |
| AFM43-OD0504-D050-A22-Z05-H                        | ●                      | 50  | 5    | 22   | 40 | 3.5  |   |   |  |   |  |
| AFM43-OD0504-D063-A22-Z06-H                        | ●                      | 63  | 6    | 22   | 40 | 3.5  |   |   |  |   |  |
| AFM43-OD0504-D080-A27-Z07-H                        | ●                      | 80  | 7    | 27   | 50 | 3.5  |   |   |  |   |  |
| AFM43-OD0504-D100-A32-Z08-H                        | ●                      | 100   | 8    | 32   | 50 | 3.5  |   |   |  |   |  |
|  |                        |   |      |      |    |      |   |   |  |   |  |

R: Sağ / Right / Rechts L: Sol / Left / Links

● Stokta / In Stock / Auf Lager ○ Stokta Yok / Non Stock Item / Kein Lagerartikel, Lieferzeit auf Anfrage  
WLTR Ucuna Uygun. / Compatible with WLTR Insert. / Kompatibel mit WLTR

Sipariş Örneği/Ordering Example/Bestellbeispiel

1 ad./pcs./stück AFM42C-XD0806-D063-A27-Z04-H

Kesme Hesabı : S 377 / Cutting Calculation : P 377 / Schnittberechnung : P 377

Montaj Ölçüleri : S 374 / Mounting Reference : P 374 / Montagehinweis : P374



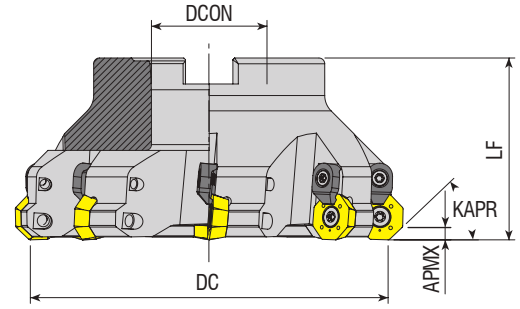

| Takım Kodu<br>Ordering Code<br>Bestell-Bezeichnung | Stok<br>Stock<br>Lager | Takım Ölçüleri (mm)<br>Dimension (mm)<br>Abmessung (mm) |      |      |    |      | Kesici Uç<br>Insert<br>Wendeschneidplatte | Yedek Parçaları / Spare Parts / Ersatzteile |   |  |  |   |
|--|------------------------|---|------|------|----|------|---|---|---|--|--|---|
|  |                        | DC  | ZEFP | DCON | LF | APMX |   | Sıkma Vidası<br>Screw<br>Schraube           | Baskı Parçası<br>Wedge Clamp<br>Spannpratze | Baskı Vidası<br>Clamp Screw<br>Klemmschraube | Tork Anahtar<br>Torx Key<br>Torx-Schlüssel | Montaj Vidası<br>Mounting Screw<br>Befestigungsschraube |
| AFM43C-OD0605-D080-A27-Z06-H                       | ●                      | 80  | 6    | 27   | 50 | 4    | OD.. 0605..                               | 1020-M5x11                                  | ACK-05                                      | 4015-M4x11                                   | 80-T20                                     | 2510-M12x35   |
| AFM43C-OD0605-D100-A32-Z07-H                       | ●                      | 100   | 7    | 32   | 50 | 4    |   |   |   |  |  | 2514-M16x35   |
| AFM43C-OD0605-D125-B40-Z08                         | ●                      | 125   | 8    | 40   | 63 | 4    |   |   |   |  |  | -   |

WLTR-LMN Ucuna Uygunur. / Compatible with WLTR-LMN Insert./Kompatibel mit WLTR-LMN

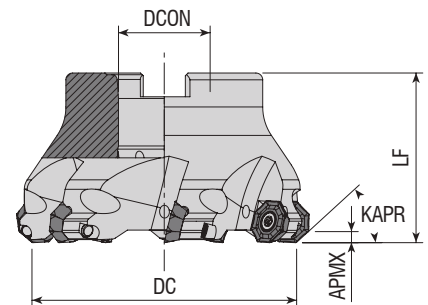

| Takım Kodu<br>Ordering Code<br>Bestell-Bezeichnung | Stok<br>Stock<br>Lager | Takım Ölçüleri (mm)<br>Dimension (mm)<br>Abmessung (mm) |      |      |    |      | Kesici Uç<br>Insert<br>Wendeschneidplatte | Yedek Parçaları / Spare Parts / Ersatzteile |  |   |
|--|------------------------|---|------|------|----|------|---|---|--|---|
|  |                        | DC  | ZEFP | DCON | LF | APMX |   | Sıkma Vidası<br>Screw<br>Schraube           | Tork Anahtar<br>Torx Key<br>Torx-Schlüssel | Montaj Vidası<br>Mounting Screw<br>Befestigungsschraube |
| AFM43-OF05T3-D050-A22-Z05-H                        | ●                      | 50  | 5    | 22   | 40 | 3    | OF.. 05T3..                               | 4015-M4x9                                   | 80-T15                                     | 2407-M10x30   |
| AFM43-OF05T3-D063-A22-Z06-H                        | ●                      | 63  | 6    | 22   | 40 | 3    |   |   |  | 2510-M12x35   |
| AFM43-OF05T3-D080-A27-Z07-H                        | ●                      | 80  | 7    | 27   | 50 | 3    |   |   |  | -   |
| AFM43-OF05T3-D125-B40-Z09                          | ●                      | 125   | 9    | 40   | 63 | 3    |   |   |  | -   |

R: Sağ / Right / Rechts L: Sol / Left / Links

● Stokta / In Stock / Auf Lager ○ Stokta Yok / Non Stock Item / Kein Lagerartikel, Lieferzeit auf Anfrage  
ISO Ucuna Uygunur. / Compatible with ISO Insert. / Kompatibel mit ISO Wendeplatten.

Sipariş Örneği/Ordering Example/Bestellbeispiel

1 ad./pcs./stück AFM43C-OD0605-D080-A27-Z06-H

Kesme Hesabı : S 377 / Cutting Calculation : P 377 / Schnittberechnung : P 377

Montaj Ölçüleri : S 374 / Mounting Reference : P 374 / Montagehinweis : P374

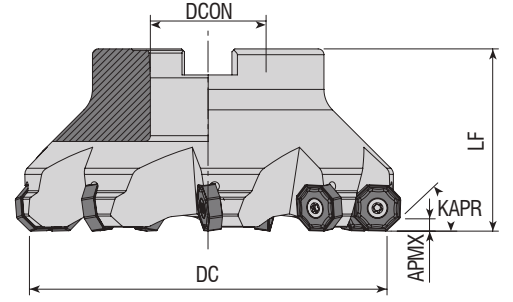

| Takım Kodu<br>Ordering Code<br>Bestell-Bezeichnung | Stok<br>Stock<br>Lager | Takım Ölçüleri (mm)<br>Dimension (mm)<br>Abmessung (mm) |      |      |    |      | Kesici Uç<br>Insert<br>Wendeschneidplatte | Yedek Parçaları / Spare Parts / Ersatzteile |  |   |             |
|--|------------------------|---|------|------|----|------|---|---|--|---|-------------|
|  |                        | DC  | ZEFP | DCON | LF | APMX |   | Sıkma Vidası<br>Screw<br>Schraube           | Tork Anahtar<br>Torx Key<br>Torx-Schlüssel | Montaj Vidası<br>Mounting Screw<br>Befestigungsschraube |             |
| AFM43-ON0604-D050-A22-Z05-H                        | ●                      | 50  | 5    | 22   | 40 | 4    | ON.. 0604..                               |   |  |   |             |
| AFM43-ON0604-D063-A22-Z06-H                        | ●                      | 63  | 6    | 22   | 40 | 4    |   |   |  |   | 2407-M10x30 |
| AFM43-ON0604-D080-A27-Z07-H                        | ●                      | 80  | 7    | 27   | 50 | 4    |   |   |  |   | 2510-M12x35 |
| AFM43-ON0604-D100-A32-Z08-H                        | ●                      | 100   | 8    | 32   | 50 | 4    |   |   |  |   | 2514-M16x35 |
| AFM43-ON0604-D125-B40-Z09                          | ●                      | 125   | 9    | 40   | 63 | 4    |   |   |  |   | -           |

ZCC Ucuna Uygunur. / Compatible with ZCC Insert. / Kompatibel mit ZCC Wendeplatten.

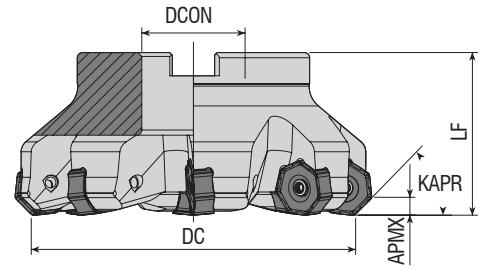

| Takım Kodu<br>Ordering Code<br>Bestell-Bezeichnung | Stok<br>Stock<br>Lager | Takım Ölçüleri (mm)<br>Dimension (mm)<br>Abmessung (mm) |      |      |    |      | Kesici Uç<br>Insert<br>Wendeschneidplatte | Yedek Parçaları / Spare Parts / Ersatzteile |  |   |                            |
|--|------------------------|---|------|------|----|------|---|---|--|---|----------------------------|
|  |                        | DC  | ZEFP | DCON | LF | APMX |   | Sıkma Vidası<br>Screw<br>Schraube           | Tork Anahtar<br>Torx Key<br>Torx-Schlüssel | Montaj Vidası<br>Mounting Screw<br>Befestigungsschraube |                            |
| AFM44-ON0606-D063-A22-Z06-H                        | ●                      | 63  | 6    | 22   | 40 | 3.8  | ONHX 0606..                               |   |  |   |                            |
| AFM44-ON0606-D080-A27-Z08-H                        | ●                      | 80  | 8    | 27   | 50 | 3.8  |   |   |  |   | 2407-M10x30                |
| AFM44-ON0606-D100-A32-Z10-H                        | ●                      | 100   | 10   | 32   | 50 | 3.8  |   |   |  |   | 2510-M12x35<br>2514-M16x35 |

R: Sağ / Right / Rechts L: Sol / Left / Links

● Stokta / In Stock / Auf Lager ○ Stokta Yok / Non Stock Item / Kein Lagerartikel, Lieferzeit auf Anfrage

KRLY Ucuna Uygunur. / Compatible with KRLY Insert./Kompatibel mit KRYL Wendeplatten.

Sipariş Örneği/Ordering Example/Bestellbeispiel

1 ad./pcs./stück AFM43-ON0604-D050-A22-Z05-H

Kesme Hesabı : S 377 / Cutting Calculation : P 377 / Schnittberechnung : P 377

Montaj Ölçüleri : S 374/ Mounting Reference : P 374 / Montagehinweis : P374

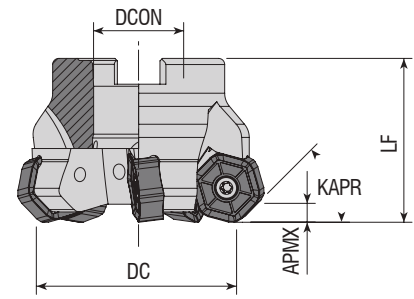

| Takım Kodu<br>Ordering Code<br>Bestell-Bezeichnung | Stok<br>Stock<br>Lager | Takım Ölçüleri (mm)<br>Dimension (mm)<br>Abmessung (mm) |      |      |    |      | Kesici Uç<br>Insert<br>Wendeschneidplatte | Yedek Parçaları / Spare Parts / Ersatzteile |  |   |             |
|--|------------------------|---|------|------|----|------|---|---|--|---|-------------|
|  |                        | DC  | ZEFP | DCON | LF | APMX |   | Sıkma Vidası<br>Screw<br>Schraube           | Tork Anahtar<br>Torx Key<br>Torx-Schlüssel | Montaj Vidası<br>Mounting Screw<br>Befestigungsschraube |             |
| AFM45-HN0905-D050-A22-Z05-H                        | ●                      | 50  | 5    | 22   | 40 | 4.5  | HN.. 0905..                               | 4015-M4x11                                  | 80-T15                                     | -   |             |
| AFM45-HN0905-D063-A22-Z06-H                        | ●                      | 63  | 6    | 22   | 40 | 4.5  |   |   |  |   | 2407-M10x30 |
| AFM45-HN0905-D080-A27-Z07-H                        | ●                      | 80  | 7    | 27   | 50 | 4.5  |   |   |  |   | 2510-M12x35 |
| AFM45L-HN0905-D100-A32-Z08-H                       | ●                      | 100   | 8    | 32   | 50 | 4.5  |   |   |  |   | 2514-M16x35 |
| AFM45-HN0905-D125-B40-Z10                          | ●                      | 125   | 10   | 40   | 63 | 4.5  |   |   |  |   |             |
| AFM45L-HN0905-D125-B40-Z10                         | ●                      | 125   | 10   | 40   | 63 | 4.5  |   |   |  |   |             |
| AFM45-HN0905-D160-C40-Z12                          | ●                      | 160   | 12   | 40   | 63 | 4.5  |   |   |  |   |             |
| AFM45L-HN0905-D160-C40-Z12                         | ●                      | 160   | 12   | 40   | 63 | 4.5  |   |   |  |   |             |
| AFM45-HN0905-D200-C60-Z16                          | ●                      | 200   | 16   | 60   | 63 | 4.5  |   |   |  |   |             |
| AFM45L-HN0905-D200-C60-Z16                         | ●                      | 200   | 16   | 60   | 63 | 4.5  |   |   |  |   |             |

WDA Ucuna Uygun. / Compatible with WDA Insert. / Kompatibel mit WDA Wendeplatten.

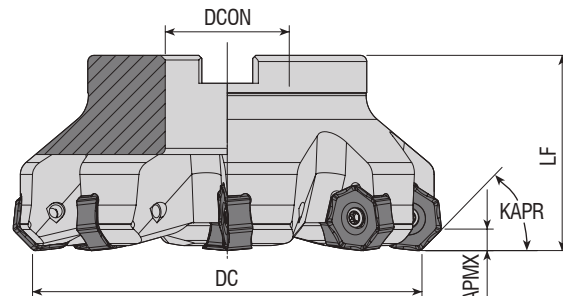

| Takım Kodu<br>Ordering Code<br>Bestell-Bezeichnung | Stok<br>Stock<br>Lager | Takım Ölçüleri (mm)<br>Dimension (mm)<br>Abmessung (mm) |      |      |    |      | Kesici Uç<br>Insert<br>Wendeschneidplatte | Yedek Parçaları / Spare Parts / Ersatzteile |  |   |             |
|--|------------------------|---|------|------|----|------|---|---|--|---|-------------|
|  |                        | DC  | ZEFP | DCON | LF | APMX |   | Sıkma Vidası<br>Screw<br>Schraube           | Tork Anahtar<br>Torx Key<br>Torx-Schlüssel | Montaj Vidası<br>Mounting Screw<br>Befestigungsschraube |             |
| AFM40-NN2007-D080-A27-Z06-H                        | ●                      | 80  | 6    | 27   | 50 | 6    | NNMU 2007..                               | 1020-M5x14                                  | 80-T20                                     | -   |             |
| AFM40-NN2007-D100-B32-Z07-H                        | ●                      | 100   | 7    | 32   | 50 | 6    |   |   |  |   | 2514-M16x35 |
| AFM40-NN2007-D125-B40-Z08-H                        | ●                      | 125   | 8    | 40   | 63 | 6    |   |   |  |   |             |
| AFM40-NN2007-D160-C40-Z10                          | ●                      | 160   | 10   | 40   | 63 | 6    |   |   |  |   |             |
| AFM40-NN2007-D200-C60-Z12                          | ●                      | 200   | 12   | 60   | 63 | 6    |   |   |  |   |             |

R: Sağ / Right / Rechts L: Sol / Left / Links

● Stokta / In Stock / Auf Lager ○ Stokta Yok / Non Stock Item / Kein Lagerartikel, Lieferzeit auf Anfrage

MTSBH Ucuna Uygun. / Compatible with MTSBH Insert. / Kompatibel mit MTSBH Wendeplatten.

Sipariş Örneği/Ordering Example/Bestellbeispiel

1 ad./pcs./stück AFM45-HN0905-D050-A22-Z05-H

Kesme Hesabı : S 377 / Cutting Calculation : P 377 / Schnittberechnung : P 377

Montaj Ölçüleri : S 374 / Mounting Reference : P 374 / Montagehinweis : P374

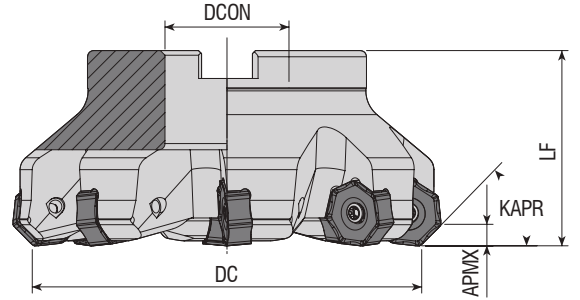

| Takım Kodu<br>Ordering Code<br>Bestell-Bezeichnung | Stok<br>Stock<br>Lager | Takım Ölçüleri (mm)<br>Dimension (mm)<br>Abmessung (mm) |     |      |    |      | Kesici Uç<br>Insert<br>Wendeschneidplatte | Yedek Parçaları / Spare Parts / Ersatzteile |  |   |
|--|------------------------|---|-----|------|----|------|---|---|--|---|
|  |                        | DC  | ZEP | DCON | LF | APMX |   | Sıkma Vidası<br>Screw<br>Schraube           | Tork Anahtar<br>Torx Key<br>Torx-Schlüssel | Montaj Vidası<br>Mounting Screw<br>Befestigungsschraube |
| • new AFM45-NN2007-D063-A22-Z05-H                  | ●                      | 63  | 5   | 22   | 50 | 6    | NNMU 2007..                               | 1020-M5x14                                  | 80-T20                                     | 2508-M10x30   |
| • new AFM45-NN2007-D080-A27-Z06-H                  | ●                      | 80  | 6   | 27   | 50 | 6    |   |   |  | 2510-M12x35   |
| AFM45-NN2007-D100-A32-Z07-H                        | ●                      | 100   | 7   | 32   | 50 | 6    |   |   |  | 2514-M16x35   |
| AFM45-NN2007-D125-B40-Z08                          | ●                      | 125   | 8   | 40   | 63 | 6    |   |   |  |   |
| AFM45-NN2007-D160-C40-Z10                          | ●                      | 160   | 10  | 40   | 63 | 6    |   |   |  |   |

R: Sağ / Right / Rechts L: Sol / Left / Links

● Stokta / In Stock / Auf Lager ○ Stokta Yok / Non Stock Item / Kein Lagerartikel, Lieferzeit auf Anfrage  
MTSBH Ucuna Uygundur. / Compatible with MTSBH Insert. / Kompatibel mit MTSBH Wendeplatten.

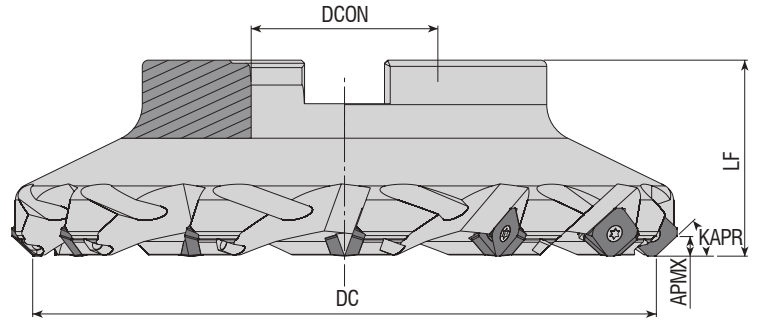

| Takım Kodu<br>Ordering Code<br>Bestell-Bezeichnung | Stok<br>Stock<br>Lager | Takım Ölçüleri (mm)<br>Dimension (mm)<br>Abmessung (mm) |     |      |    |      | Kesici Uç<br>Insert<br>Wendeschneidplatte | Yedek Parçaları / Spare Parts / Ersatzteile |  |   |
|--|------------------------|---|-----|------|----|------|---|---|--|---|
|  |                        | DC  | ZEP | DCON | LF | APMX |   | Sıkma Vidası<br>Screw<br>Schraube           | Tork Anahtar<br>Torx Key<br>Torx-Schlüssel | Montaj Vidası<br>Mounting Screw<br>Befestigungsschraube |
| AFM45-SE12-D050-A22-Z04-H                          | ●                      | 50  | 4   | 22   | 40 | 6    | SE.. 12T3..<br>R245-12T3..                | 4015-M3.5x11                                | 80-T15                                     | 2407-M10x30   |
| AFM45L-SE12-D050-A22-Z04-H                         | ●                      | 50  | 4   | 22   | 40 | 6    |   |   |  | 2510-M12x35   |
| AFM45-SE12-D063-A22-Z05-H                          | ●                      | 63  | 5   | 22   | 40 | 6    |   |   |  | 2514-M16x35   |
| AFM45L-SE12-D063-A22-Z05-H                         | ●                      | 63  | 5   | 22   | 40 | 6    |   |   |  |   |
| AFM45-SE12-D080-A27-Z06-H                          | ●                      | 80  | 6   | 27   | 50 | 6    |   |   |  |   |
| AFM45L-SE12-D080-A27-Z06-H                         | ●                      | 80  | 6   | 27   | 50 | 6    |   |   |  |   |
| AFM45-SE12-D100-A32-Z07-H                          | ●                      | 100   | 7   | 32   | 50 | 6    |   |   |  |   |
| AFM45-SE12-D125-B40-Z08                            | ●                      | 125   | 8   | 40   | 63 | 6    |   |   |  |   |
| AFM45-SE12-D160-C40-Z10                            | ●                      | 160   | 10  | 40   | 63 | 6    |   |   |  |   |
| AFM45L-SE12-D160-C40-Z10                           | ●                      | 160   | 10  | 40   | 63 | 6    |   |   |  |   |
| AFM45-SE12-D200-C60-Z12                            | ●                      | 200   | 12  | 60   | 63 | 6    |   |   |  |   |

ZCC-SNDVK Ucuna Uygundur. / Compatible with ZCC-SNDVK Insert. / Kompatibel mit ZCC-SNDVK Wendeplatten.

Sipariş Örneği/Ordering Example/Bestellbeispiel

1 ad./pcs./stück AFM45-NN2007-D063-A22-Z05-H

Kesme Hesabı : S 377 / Cutting Calculation : P 377 / Schnittberechnung : P 377

Montaj Ölçüleri : S 374 / Mounting Reference : P 374 / Montagehinweis : P374

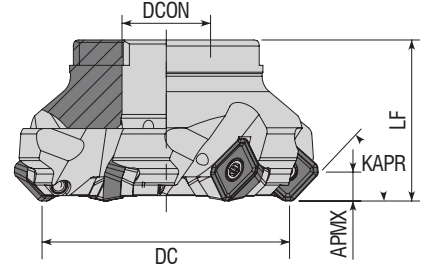

| Takım Kodu<br>Ordering Code<br>Bestell-Bezeichnung | Stok<br>Stock<br>Lager | Takım Ölçüleri (mm)<br>Dimension (mm)<br>Abmessung (mm) |      |      |    |      | Kesici Uç<br>Insert<br>Wendeschneidplatte | Yedek Parçaları / Spare Parts / Ersatzteile |   |                                   |  |   |
|--|------------------------|---|------|------|----|------|---|---|---|-----------------------------------|--|---|
|  |                        | DC  | ZEFP | DCON | LF | APMX |   | Altlık<br>Screw<br>Unterlage                | Altlık Vidası<br>Wedge Clamp<br>Винт опорной пластины | Sıkma Vidası<br>Screw<br>Schraube | Tork Anahtar<br>Torx Key<br>Torx-Schlüssel | Montaj Vidası<br>Mounting Screw<br>Befestigungsschraube |
| AFM45-SE13-D050-A22-Z04-H                          | ●                      | 50  | 4    | 22   | 40 | 6    | SEMT 13T3..                               | AASE-3-0001                                 | AAV-16-M3.5x8   | 4015-M3.5x11                      | 80-T15                                     | 2407-M10x30   |
| AFM45-SE13-D063-A22-Z05-H                          | ●                      | 63  | 5    | 22   | 40 | 6    |   |   |   |                                   |  |   |
| AFM45-SE13-D080-A27-Z06-H                          | ●                      | 80  | 6    | 27   | 50 | 6    |   |   |   |                                   |  |   |
| AFM45S-SE13-D050-A22-Z05-H                         | ●                      | 50  | 5    | 22   | 40 | 6    |   |   |   |                                   |  |   |
| AFM45S-SE13-D063-A22-Z06-H                         | ●                      | 63  | 6    | 22   | 40 | 6    |   |   |   |                                   |  |   |
| AFM45S-SE13-D080-A27-Z08-H                         | ●                      | 80  | 8    | 27   | 50 | 6    |   |   |   |                                   |  |   |
| AFM45S-SE13-D100-A32-Z10-H                         | ●                      | 100   | 10   | 32   | 50 | 6    |   |   |   |                                   |  |   |
| AFM45S-SE13-D125-B40-Z12                           | ●                      | 125   | 12   | 40   | 63 | 6    |   |   |   |                                   |  |   |

R: Sağ / Right / Rechts L: Sol / Left / Links

● Stokta / In Stock / Auf Lager ○ Stokta Yok / Non Stock Item / Kein Lagerartikel, Lieferzeit auf Anfrage

SMTM-DJT Ucuna Uygundur. / Compatible with SMTM-DJT Insert. / Kompatibel mit SMTM-DJT Wendeplatten.

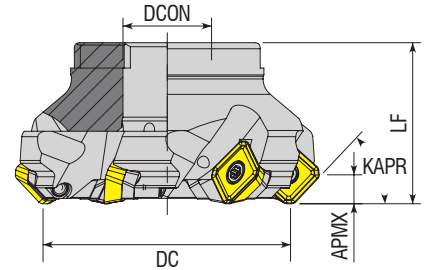

| Takım Kodu<br>Ordering Code<br>Bestell-Bezeichnung | Stok<br>Stock<br>Lager | Takım Ölçüleri (mm)<br>Dimension (mm)<br>Abmessung (mm) |      |      |    |      | Kesici Uç<br>Insert<br>Wendeschneidplatte | Yedek Parçaları / Spare Parts / Ersatzteile |  |   |
|--|------------------------|---|------|------|----|------|---|---|--|---|
|  |                        | DC  | ZEFP | DCON | LF | APMX |   | Sıkma Vidası<br>Screw<br>Schraube           | Tork Anahtar<br>Torx Key<br>Torx-Schlüssel | Montaj Vidası<br>Mounting Screw<br>Befestigungsschraube |
| AFM45-SE13M-D050-A22-Z04-H                         | ●                      | 50  | 4    | 22   | 40 | 6    | SEMT 13T3..                               | 4015-M3.5x11                                | 80-T15                                     | 2508-M10x30   |
| AFM45-SE13M-D063-A22-Z05-H                         | ●                      | 63  | 5    | 22   | 40 | 6    |   |   |  |   |
| AFM45-SE13M-D080-A27-Z06                           | ●                      | 80  | 6    | 27   | 50 | 6    |   |   |  |   |
| AFM45-SE13M-D100-A32-Z07                           | ●                      | 100   | 7    | 32   | 50 | 6    |   |   |  |   |
| AFM45-SE13M-D125-B40-Z08                           | ●                      | 125   | 8    | 40   | 63 | 6    |   |   |  |   |

MTSBH Ucuna Uygundur. / Compatible with MTSBH Insert. / Kompatibel mit MTSBH Wendeplatten.

Sipariş Örneği/Ordering Example/Bestellbeispiel

1 ad./pcs./stück AFM45-SE13-D050-A22-Z04-H

Kesme Hesabı : S 377 / Cutting Calculation : P 377 / Schnittberechnung : P 377

Montaj Ölçüleri : S 374 / Mounting Reference : P 374 / Montagehinweis : P 374



KAPR=45°

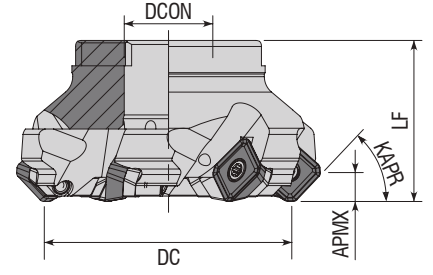

| Takım Kodu<br>Ordering Code<br>Bestell-Bezeichnung | Stok<br>Stock<br>Lager | Takım Ölçüleri (mm)<br>Dimension (mm)<br>Abmessung (mm) |      |      |    |      | Kesici Uç<br>Insert<br>Wendeschneidplatte | Yedek Parçaları / Spare Parts / Ersatzteile |   |                                   |  |   |             |
|--|------------------------|---|------|------|----|------|---|---|---|-----------------------------------|--|---|-------------|
|  |                        | DC  | ZEFP | DCON | LF | APMX |   | Altlık<br>Screw<br>Unterlage                | Altlık Vidası<br>Wedge Clamp<br>Винт опорной пластины | Sıkma Vidası<br>Screw<br>Schraube | Tork Anahtar<br>Torx Key<br>Torx-Schlüssel | Montaj Vidası<br>Mounting Screw<br>Befestigungsschraube |             |
| AFM45S-SE13M-D050-A22-Z04-H                        | ●                      | 50  | 4    | 22   | 40 | 6    | SEMT 13T3..                               | AASE-3-0001                                 | AAV-16-M3.5x8   | 4015-M3.5x12                      | 80-T15                                     | 2508-M10x30   |             |
| AFM45S-SE13M-D063-A22-Z05-H                        | ●                      | 63  | 5    | 22   | 40 | 6    |   |   |   |                                   |  |   | 2510-M12x35 |
| AFM45S-SE13M-D080-A27-Z06                          | ●                      | 80  | 6    | 27   | 50 | 6    |   |   |   |                                   |  |   | 2514-M16x35 |
| AFM45S-SE13M-D100-A32-Z07                          | ●                      | 100   | 7    | 32   | 50 | 6    |   |   |   |                                   |  |   | -           |
| AFM45S-SE13M-D125-B40-Z08                          | ●                      | 125   | 8    | 40   | 63 | 6    |   |   |   |                                   |  |   | -           |

MTSBH Ucuna Uygundur. / Compatible with MTSBH Insert. / Kompatibel mit MTSBH Wendeplatten.

KAPR=45°

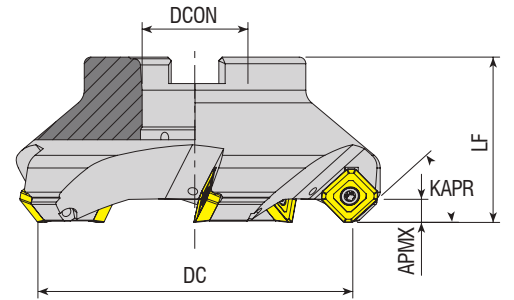

| Takım Kodu<br>Ordering Code<br>Bestell-Bezeichnung | Stok<br>Stock<br>Lager | Takım Ölçüleri (mm)<br>Dimension (mm)<br>Abmessung (mm) |      |      |    |      | Kesici Uç<br>Insert<br>Wendeschneidplatte | Yedek Parçaları / Spare Parts / Ersatzteile |  |   |
|--|------------------------|---|------|------|----|------|---|---|--|---|
|  |                        | DC  | ZEFP | DCON | LF | APMX |   | Sıkma Vidası<br>Screw<br>Schraube           | Tork Anahtar<br>Torx Key<br>Torx-Schlüssel | Montaj Vidası<br>Mounting Screw<br>Befestigungsschraube |
| AFM45-SE14M4-D063-A22-Z04-H                        | ●                      | 63  | 4    | 22   | 40 | 7    | SE.. 14M4..                               | 4015-M3.5x11                                | 80-T15                                     | 2407-M10x30   |
| AFM45-SE14M4-D080-A27-Z05-H                        | ●                      | 80  | 5    | 27   | 50 | 7    |   |   |  | 2510-M12x35   |
| AFM45-SE14M4-D100-A32-Z05-H                        | ●                      | 100   | 5    | 32   | 50 | 7    |   |   |  | 2514-M16x35   |
| AFM45-SE14M4-D125-B40-Z06                          | ●                      | 125   | 6    | 40   | 63 | 7    |   |   |  | -   |
| AFM45-SE14M4-D160-C40-Z07                          | ●                      | 160   | 7    | 40   | 63 | 7    |   |   |  | -   |

R: Sağ / Right / Rechts L: Sol / Left / Links

● Stokta / In Stock / Auf Lager ○ Stokta Yok / Non Stock Item / Kein Lagerartikel, Lieferzeit auf Anfrage  
KRLY Ucuna Uygundur. / Compatible with KRLY Insert. / Kompatibel mit KRYL Wendeplatten.

Sipariş Örneği/Ordering Example/Bestellbeispiel

1 ad./pcs./stück AFM45S-SE13M-D050-A22-Z04-H

Kesme Hesabı : S 377 | Cutting Calculation : P 377 | Schnittberechnung : P 377

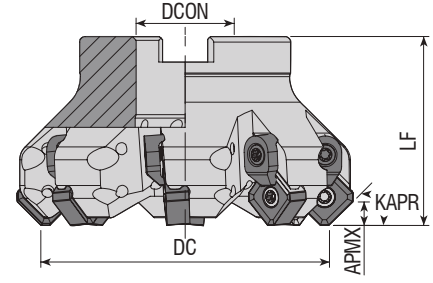

**Takım Kodu**  
**Ordering Code**  
*Bestell-Bezeichnung*

Stok  
Stock  
Lager

Takım Ölçüleri (mm)  
Dimension (mm)  
Abmessung (mm)

Kesici Uç  
Insert  
Wendeschneidplatte

Sıkma Vidası  
Screw  
Schraube

Baskı Parçası  
Wedge Clamp  
Spannpratze

Baskı Vidası  
Clamp Screw  
Klemmschraube

Tork Anahtar  
Torx Key  
Torx-Schlüssel

Montaj Vidası  
Mounting Screw  
Befestigungsschraube

Yedek Parçaları / Spare Parts / Ersatzteile

|                               | DC | ZEFP | DCON | LF | APMX |   |           |            |        |            |        |             |
|-------------------------------|----|------|------|----|------|---|-----------|------------|--------|------------|--------|-------------|
| AFM45C-SN12..-D050-A22-Z04-H  | ●  | 50   | 4    | 22 | 42   | 6 | SN.. 12.. | 1015-M4x11 | ACK-05 | 4015-M4x11 | 80-T15 | 2407-M10x30 |
| AFM45C-SN12..-D050-A22-Z05-H  | ●  | 50   | 5    | 22 | 42   | 6 |           |            |        |            |        |             |
| AFM45C-SN12..-D063-A22-Z06-H  | ●  | 63   | 6    | 22 | 42   | 6 |           |            |        |            |        |             |
| AFM45C-SN12..-D063-A22-Z07-H  | ●  | 63   | 7    | 22 | 42   | 6 |           |            |        |            |        |             |
| AFM45CL-SN12..-D063-A22-Z07-H | ●  | 63   | 7    | 22 | 42   | 6 |           |            |        |            |        |             |
| AFM45C-SN12..-D080-A27-Z07-H  | ●  | 80   | 7    | 27 | 52   | 6 |           |            |        |            |        |             |
| AFM45C-SN12..-D080-A27-Z08-H  | ●  | 80   | 8    | 27 | 52   | 6 |           |            |        |            |        |             |
| AFM45CL-SN12..-D080-A27-Z08-H | ●  | 80   | 8    | 27 | 52   | 6 |           |            |        |            |        |             |
| AFM45C-SN12..-D100-A32-Z08-H  | ●  | 100  | 8    | 32 | 52   | 6 |           |            |        |            |        |             |
| AFM45C-SN12..-D100-A32-Z10-H  | ●  | 100  | 10   | 32 | 52   | 6 |           |            |        |            |        |             |
| AFM45CL-SN12..-D100-A32-Z10-H | ●  | 100  | 10   | 32 | 52   | 6 |           |            |        |            |        |             |
| AFM45C-SN12..-D125-B40-Z11    | ●  | 125  | 11   | 40 | 65   | 6 |           |            |        |            |        |             |
| AFM45CL-SN12..-D125-B40-Z11   | ●  | 125  | 11   | 40 | 65   | 6 |           |            |        |            |        |             |
| AFM45C-SN12..-D160-C40-Z12    | ●  | 160  | 12   | 40 | 65   | 6 |           |            |        |            |        |             |
| AFM45C-SN12..-D200-C60-Z14    | ●  | 200  | 14   | 60 | 65   | 6 |           |            |        |            |        |             |
| AFM45CL-SN12..-D200-C60-Z14   | ●  | 200  | 14   | 60 | 65   | 6 |           |            |        |            |        |             |

R: Sağ / Right / Rechts L: Sol / Left / Links

● Stokta / In Stock / Auf Lager ○ Stokta Yok / Non Stock Item / Kein Lagerartikel, Lieferzeit auf Anfrage

WLTR-LMN-ACHTK Ucuna Uygunudur. / Compatible with WLTR-LMN-ACHTK Insert. / Kompatibel mit WLTR-LMN-ACHTK Wendeplatten.

Sipariş Örneği/Ordering Example/Bestellbeispiel

1 ad./pcs./stück AFM45C-SN12..-D050-A22-Z04-H

Kesme Hesabı : S 377 / Cutting Calculation : P 377 / Schnittberechnung : P 377



Montaj Ölçüleri : S 374 / Mounting Reference : P 374 / Montagehinweis : P374

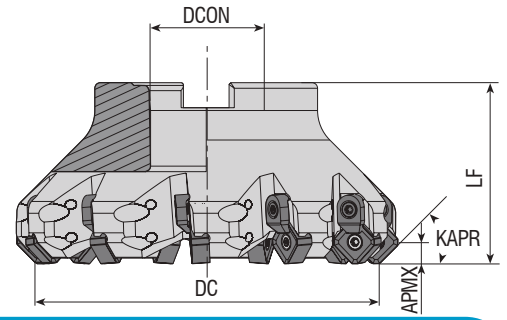

| Takım Kodu<br>Ordering Code<br>Bestell-Bezeichnung | Stok<br>Stock<br>Lager | Takım Ölçüleri (mm)<br>Dimension (mm)<br>Abmessung (mm) |      |      |    |      | Kesici Uç<br>Insert<br>Wendeschneidplatte | Yedek Parçaları / Spare Parts / Ersatzteile |   |  |  |   |             |
|--|------------------------|---|------|------|----|------|---|---|---|--|--|---|-------------|
|  |                        | DC  | ZEFP | DCON | LF | APMX |   | Sıkma Vidası<br>Screw<br>Schraube           | Baskı Parçası<br>Wedge Clamp<br>Spannpratze | Baskı Vidası<br>Clamp Screw<br>Klemmschraube | Tork Anahtar<br>Torx Key<br>Torx-Schlüssel | Montaj Vidası<br>Mounting Screw<br>Befestigungsschraube |             |
| AFM45C-SN1206-D050-A22-Z04-H                       | ●                      | 50  | 4    | 22   | 42 | 6    | SN.. 1206..                               | 4015-M4x11                                  | ACK-05                                      | 4015-M4x11                                   | 80-T15                                     | 2510-M12x35   |             |
| AFM45CL-SN1206-D050-A22-Z05-H                      | ●                      | 50  | 5    | 22   | 42 | 6    |   |   |   |  |  |   |             |
| AFM45C-SN1206-D050-A22-Z05-H                       | ●                      | 50  | 5    | 22   | 42 | 6    |   |   |   |  |  |   |             |
| AFM45C-SN1206-D063-A22-Z06-H                       | ●                      | 63  | 6    | 22   | 42 | 6    |   |   |   |  |  |   | 2407-M10x30 |
| AFM45C-SN1206-D063-A22-Z07-H                       | ●                      | 63  | 7    | 22   | 42 | 6    |   |   |   |  |  |   |             |
| AFM45CL-SN1206-D063-A22-Z07-H                      | ●                      | 63  | 7    | 22   | 42 | 6    |   |   |   |  |  |   |             |
| AFM45C-SN1206-D080-A27-Z07-H                       | ●                      | 80  | 7    | 27   | 52 | 6    |   |   |   |  |  |   |             |
| AFM45C-SN1206-D080-A27-Z08-H                       | ●                      | 80  | 8    | 27   | 52 | 6    |   |   |   |  |  |   | 2510-M12x35 |
| AFM45CL-SN1206-D080-A27-Z08-H                      | ●                      | 80  | 8    | 27   | 52 | 6    |   |   |   |  |  |   |             |
| AFM45C-SN1206-D100-A32-Z08-H                       | ●                      | 100   | 8    | 32   | 52 | 6    |   |   |   |  |  |   |             |
| AFM45C-SN1206-D100-A32-Z10-H                       | ●                      | 100   | 10   | 32   | 52 | 6    |   |   |   |  |  |   | 2514-M16x35 |
| AFM45CL-SN1206-D100-A32-Z10-H                      | ●                      | 100   | 10   | 32   | 52 | 6    |   |   |   |  |  |   |             |
| AFM45C-SN1206-D125-B40-Z11                         | ●                      | 125   | 11   | 40   | 65 | 6    |   |   |   |  |  |   |             |
| AFM45CL-SN1206-D125-B40-Z11                        | ●                      | 125   | 11   | 40   | 65 | 6    |   |   |   |  |  |   |             |
| AFM45C-SN1206-D160-C40-Z12                         | ●                      | 160   | 12   | 40   | 65 | 6    |   |   |   |  |  |   | 1015-M4x11  |
| AFM45CL-SN1206-D160-C40-Z12                        | ●                      | 160   | 12   | 40   | 65 | 6    |   |   |   |  |  |   |             |
| AFM45C-SN1206-D200-C60-Z14                         | ●                      | 200   | 14   | 60   | 65 | 6    |   |   |   |  |  |   | -           |
| AFM45CL-SN1206-D200-C60-Z14                        | ●                      | 200   | 14   | 60   | 65 | 6    |   |   |   |  |  |   |             |

KRLY-PLBT-BHLR Ucuna Uygun. / Compatible with KRLY-PLBT-BHLR Insert. / Kompatibel mit KRLY-PLBT-BHLR Wendeplatten.

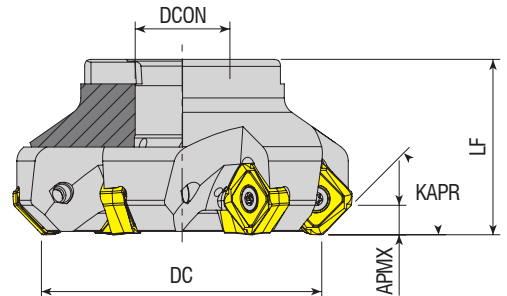

| Takım Kodu<br>Ordering Code<br>Bestell-Bezeichnung | Stok<br>Stock<br>Lager | Takım Ölçüleri (mm)<br>Dimension (mm)<br>Abmessung (mm) |      |      |    |      | Kesici Uç<br>Insert<br>Wendeschneidplatte | Yedek Parçaları / Spare Parts / Ersatzteile |  |   |
|--|------------------------|---|------|------|----|------|---|---|--|---|
|  |                        | DC  | ZEFP | DCON | LF | APMX |   | Sıkma Vidası<br>Screw<br>Schraube           | Tork Anahtar<br>Torx Key<br>Torx-Schlüssel | Montaj Vidası<br>Mounting Screw<br>Befestigungsschraube |
| AFM45-SA1706-D080-A27-Z06-H                        | ●                      | 80  | 6    | 27   | 50 | 8.4  | SAKU 1706..                               | 1020-M5x14                                  | 80-T20                                     | 2510-M12x35   |
| AFM45-SA1706-D100-A32-Z07-H                        | ●                      | 100   | 7    | 32   | 50 | 8.4  |   |   |  | 2514-M16x35   |
| AFM45-SA1706-D125-B40-Z09                          | ●                      | 125   | 9    | 40   | 63 | 8.4  |   |   |  | -   |

R: Sağ / Right / Rechts L: Sol / Left / Links

● Stokta / In Stock / Auf Lager ○ Stokta Yok / Non Stock Item / Kein Lagerartikel, Lieferzeit auf Anfrage

CRTZT Ucuna Uygun. / Compatible with CRTZT Insert. / Kompatibel mit CRTZT Wendeplatten.

Sipariş Örneği/Ordering Example/Bestellbeispiel

1 ad./pcs./stück AFM45C-SN1206-D050-A22-Z04-H

Kesme Hesabı : S 377 / Cutting Calculation : P 377 / Schnittberechnung : P 377

Montaj Ölçüleri : S 374 / Mounting Reference : P 374 / Montagehinweis : P 374



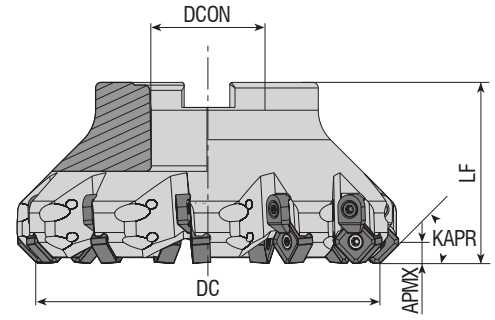

| Takım Kodu<br>Ordering Code<br>Bestell-Bezeichnung | Stok<br>Stock<br>Lager | Takım Ölçüleri (mm)<br>Dimension (mm)<br>Abmessung (mm) |      |      |    |      | Kesici Uç<br>Insert<br>Wendeschneidplatte | Yedek Parçaları / Spare Parts / Ersatzteile |   |  |  |   |             |
|--|------------------------|---|------|------|----|------|---|---|---|--|--|---|-------------|
|  |                        | DC  | ZEFP | DCON | LF | APMX |   | Sıkma Vidası<br>Screw<br>Schraube           | Baskı Parçası<br>Wedge Clamp<br>Spannpratze | Baskı Vidası<br>Clamp Screw<br>Klemmschraube | Tork Anahtar<br>Torx Key<br>Torx-Schlüssel | Montaj Vidası<br>Mounting Screw<br>Befestigungsschraube |             |
| AFM45C-SN12Z-D050-A22-Z05-H                        | ●                      | 50  | 5    | 22   | 42 | 6    | SNEG 1205..                               |   |   |  |  |   | 2407-M10X30 |
| AFM45C-SN12Z-D063-A22-Z06-H                        | ●                      | 63  | 6    | 22   | 42 | 6    |   |   |   |  |  |   | 2510-M12x35 |
| AFM45C-SN12Z-D080-A27-Z07-H                        | ●                      | 80  | 7    | 27   | 52 | 6    |   |   |   |  |  |   | 2514-M16x35 |
| AFM45C-SN12Z-D100-A32-Z09-H                        | ●                      | 100   | 9    | 32   | 52 | 6    |   |   |   |  |  |   | -           |
| AFM45C-SN12Z-D125-B40-Z11                          | ●                      | 125   | 11   | 40   | 65 | 6    |   |   |   |  |  |   | -           |
| AFM45C-SN12Z-D160-C40-Z12                          | ●                      | 160   | 12   | 60   | 65 | 6    |   |   |   |  |  |   | -           |
| AFM45C-SN12Z-D200-C60-Z14                          | ●                      | 200   | 14   | 60   | 65 | 6    |   |   |   |  |  |   | -           |

ZCC Ucuna Uygundur. / Compatible with ZCC Insert. / Kompatibel mit ZCC Wendeplatten.

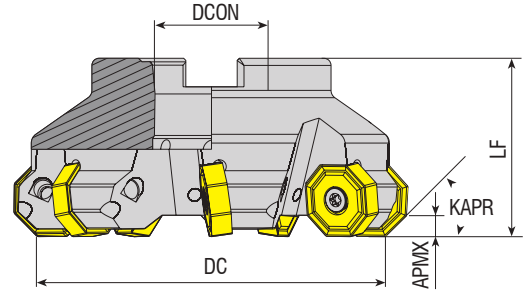

| Takım Kodu<br>Ordering Code<br>Bestell-Bezeichnung | Stok<br>Stock<br>Lager | Takım Ölçüleri (mm)<br>Dimension (mm)<br>Abmessung (mm) |      |      |    |      | Kesici Uç<br>Insert<br>Wendeschneidplatte | Yedek Parçaları / Spare Parts / Ersatzteile |  |   |             |
|--|------------------------|---|------|------|----|------|---|---|--|---|-------------|
|  |                        | DC  | ZEFP | DCON | LF | APMX |   | Sıkma Vidası<br>Screw<br>Schraube           | Tork Anahtar<br>Torx Key<br>Torx-Schlüssel | Montaj Vidası<br>Mounting Screw<br>Befestigungsschraube |             |
| new AFM45-ON0806-D050-A22-Z04-H                    | ●                      | 50  | 4    | 22   | 40 | 5.5  | ON.. 0806..                               |   |  |   | -           |
| AFM45-ON0806-D063-A22-Z05-H                        | ●                      | 63  | 5    | 22   | 40 | 5.5  |   |   |  |   | 2508-M10x30 |
| AFM45-ON0806-D063-A22-Z06-H                        | ●                      | 63  | 6    | 22   | 40 | 5.5  |   |   |  |   | 2510-M12x35 |
| new AFM45-ON0806-D063-A22-Z07-H                    | ●                      | 63  | 7    | 22   | 40 | 5.5  |   |   |  |   | 2514-M16x35 |
| AFM45-ON0806-D080-A27-Z06-H                        | ●                      | 80  | 6    | 27   | 50 | 5.5  |   |   |  |   | -           |
| AFM45-ON0806-D080-A27-Z08-H                        | ●                      | 80  | 8    | 27   | 50 | 5.5  |   |   |  |   | -           |
| AFM45-ON0806-D100-A32-Z07-H                        | ●                      | 100   | 7    | 32   | 50 | 5.5  |   |   |  |   | -           |
| new AFM45-ON0806-D100-A32-Z10                      | ●                      | 100   | 10   | 32   | 50 | 5.5  |   |   |  |   | -           |
| AFM45-ON0806-D100-A32-Z10-H                        | ●                      | 100   | 10   | 32   | 50 | 5.5  |   |   |  |   | -           |
| new AFM45L-ON0806-D100-A32-Z10-H                   | ●                      | 100   | 10   | 32   | 50 | 5.5  |   |   |  |   | -           |
| AFM45-ON0806-D125-B40-Z08                          | ●                      | 125   | 8    | 40   | 63 | 5.5  |   |   |  |   | -           |
| new AFM45L-ON0806-D125-B40-Z08                     | ●                      | 125   | 8    | 40   | 63 | 5.5  |   |   |  |   | -           |
| AFM45-ON0806-D125-B40-Z12                          | ●                      | 125   | 12   | 40   | 63 | 5.5  |   |   |  |   | -           |
| AFM45-ON0806-D160-C40-Z10                          | ●                      | 160   | 10   | 40   | 63 | 5.5  |   |   |  |   | -           |
| AFM45-ON0806-D160-C40-Z14                          | ●                      | 160   | 14   | 40   | 63 | 5.5  |   |   |  |   | -           |
| AFM45-ON0806-D200-C60-Z12                          | ●                      | 200   | 12   | 60   | 63 | 5.5  |   |   |  |   | -           |
| AFM45-ON0806-D250-C60-Z14                          | ●                      | 250   | 14   | 60   | 63 | 5.5  |   |   |  |   | -           |
| AFM45-ON0806-D315-D60-Z16                          | ●                      | 315   | 16   | 60   | 63 | 5.5  |   |   |  |   | -           |

R: Sağ / Right / Rechts L: Sol / Left / Links

● Stokta / In Stock / Auf Lager ○ Stokta Yok / Non Stock Item / Kein Lagerartikel, Lieferzeit auf Anfrage

ISO Ucuna Uygundur. / Compatible with ISO Insert. / Kompatibel mit ISO Wendeplatten.

Sipariş Örneği/Ordering Example/Bestellbeispiel

1 ad./pcs./stück AFM45C-SN12Z-D050-A22-Z05-H

Kesme Hesabı : S 377 / Cutting Calculation : P 377 / Schnittberechnung : P 377

Montaj Ölçüleri : S 374 / Mounting Reference : P 374 / Montagehinweis : P 374

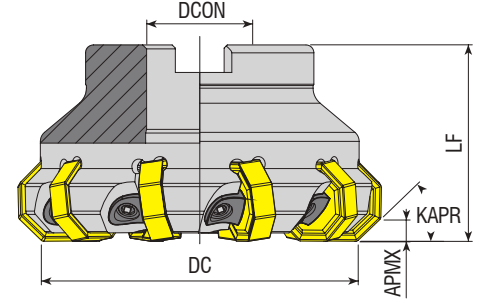

| Takım Kodu<br>Ordering Code<br>Bestell-Bezeichnung | Stok<br>Stock<br>Lager | Takım Ölçüleri (mm)<br>Dimension (mm)<br>Abmessung (mm) |      |      |    |      | Kesici Uç<br>Insert<br>Wendeschneidplatte | Yedek Parçaları / Spare Parts / Ersatzteile |  |   |   |             |
|--|------------------------|---|------|------|----|------|---|---|--|---|---|-------------|
|  |                        | DC  | ZEFP | DCON | LF | APMX |   | Baskı Parçası<br>Wedge Clamp<br>Spannpratze | Baskı Vidası<br>Clamp Screw<br>Klemmschraube | Anahtar<br>Allen Key<br>Innensechskantschlüssel | Montaj Vidası<br>Mounting Screw<br>Befestigungsschraube |             |
| <b>new</b> AFM45C-ON0806-D063-A22-Z08              | ●                      | 63  | 8    | 22   | 50 | 5.5  | ON.. 0806..                               | ACK-26                                      | AKV-26-M6x0.75x20                            | AAL-03-3  | -   | 2508-M10x30 |
| AFM45C-ON0806-D080-A27-Z10                         | ●                      | 80  | 10   | 27   | 50 | 5.5  |   |   |  |   |   | 2510-M12x35 |
| AFM45C-ON0806-D100-A32-Z14                         | ●                      | 100   | 14   | 32   | 50 | 5.5  |   |   |  |   |   | 2514-M16x35 |
| AFM45C-ON0806-D125-B40-Z18                         | ●                      | 125   | 18   | 40   | 63 | 5.5  |   |   |  |   |   | -           |
| AFM45C-ON0806-D160-C40-Z22                         | ●                      | 160   | 22   | 40   | 63 | 5.5  |   |   |  |   |   | -           |

ISO Ucuna Uygundur. / Compatible with ISO Insert. / Kompatibel mit ISO Wendeplatten.

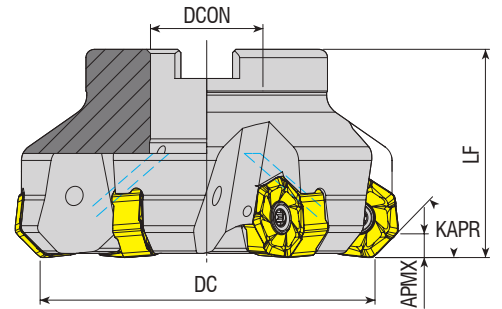

| Takım Kodu<br>Ordering Code<br>Bestell-Bezeichnung | Stok<br>Stock<br>Lager | Takım Ölçüleri (mm)<br>Dimension (mm)<br>Abmessung (mm) |      |      |    |      | Kesici Uç<br>Insert<br>Wendeschneidplatte | Yedek Parçaları / Spare Parts / Ersatzteile |   |  |  |   |
|--|------------------------|---|------|------|----|------|---|---|---|--|--|---|
|  |                        | DC  | ZEFP | DCON | LF | APMX |   | Sıkma Vidası<br>Screw<br>Schraube           | Baskı Parçası<br>Wedge Clamp<br>Spannpratze | Baskı Vidası<br>Clamp Screw<br>Klemmschraube | Tork Anahtar<br>Torx Key<br>Torx-Schlüssel | Montaj Vidası<br>Mounting Screw<br>Befestigungsschraube |
| AFM45-XN0906-D063-A22-Z06-H                        | ●                      | 63  | 6    | 22   | 50 | 5    | XNMU 0906..                               | 1120-M5x13                                  | -   | -  | 80-T20                                     | 2407-M10x30   |
| AFM45-XN0906-D080-A27-Z06-H                        | ●                      | 80  | 6    | 27   | 50 | 5    |   |   |   |  |  | 2510-M12x35   |
| AFM45-XN0906-D100-A32-Z07-H                        | ●                      | 100   | 7    | 32   | 55 | 5    |   |   |   |  |  | 2514-M16x35   |
| AFM45-XN0906-D125-B40-Z08                          | ●                      | 125   | 8    | 40   | 63 | 5    |   |   |   |  |  | -   |

R: Sağ / Right / Rechts L: Sol / Left / Links  
● Stokta / In Stock / Auf Lager ○ Stokta Yok / Non Stock Item / Kein Lagerartikel, Lieferzeit auf Anfrage  
TGTC Ucuna Uygundur. / Compatible with TGTC Insert. / Kompatibel mit TGTC Wendeplatten.

Sipariş Örneği/Ordering Example/Bestellbeispiel  
1 ad./pcs./stück AFM45C-ON0806-D063-A22-Z08  
Kesme Hesabı : S 377 / Cutting Calculation : P 377 / Schnittberechnung : P 377  
Montaj Ölçüleri : S 374 / Mounting Reference : P 374 / Montagehinweis : P 374



KAPR=45°

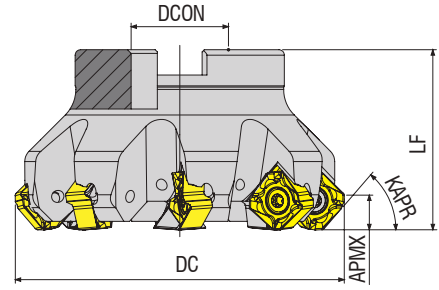

| Takım Kodu<br>Ordering Code<br>Bestell-Bezeichnung | Stok<br>Stock<br>Lager | Takım Ölçüleri (mm)<br>Dimension (mm)<br>Abmessung (mm) |      |      |    |      | Kesici Uç<br>Insert<br>Wendeschneidplatte | Yedek Parçaları / Spare Parts / Ersatzteile |  |   |             |
|--|------------------------|---|------|------|----|------|---|---|--|---|-------------|
|  |                        | DC  | ZEFP | DCON | LF | APMX |   | Sıkma Vidası<br>Screw<br>Schraube           | Tork Anahtar<br>Torx Key<br>Torx-Schlüssel | Montaj Vidası<br>Mounting Screw<br>Befestigungsschraube |             |
| AFM45-SN1306-D050-A22-Z05-H                        | ●                      | 50  | 5    | 22   | 40 | 7    | SNGX 1306..                               |   |  |   |             |
| AFM45-SN1306-D063-A22-Z06-H                        | ●                      | 63  | 6    | 22   | 40 | 7    |   |   |  |   | 2508-M10x30 |
| AFM45-SN1306-D080-A27-Z07-H                        | ●                      | 80  | 7    | 27   | 50 | 7    |   |   |  |   | 2510-M12x35 |
| AFM45-SN1306-D100-A32-Z08-H                        | ●                      | 100   | 8    | 32   | 50 | 7    |   |   |  |   | 2514-M16x35 |

TGTC Ucuna Uygunudur. / Compatible with TGTC Insert. / Kompatibel mit TGTC Wendeplatten.

KAPR=66°

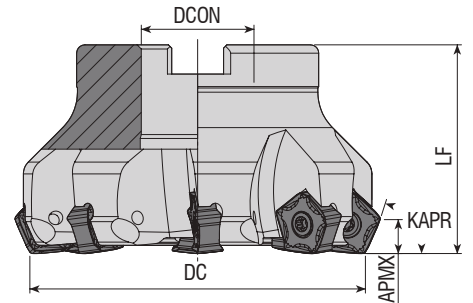

| Takım Kodu<br>Ordering Code<br>Bestell-Bezeichnung | Stok<br>Stock<br>Lager | Takım Ölçüleri (mm)<br>Dimension (mm)<br>Abmessung (mm) |      |      |    |      | Kesici Uç<br>Insert<br>Wendeschneidplatte | Yedek Parçaları / Spare Parts / Ersatzteile |  |   |             |
|--|------------------------|---|------|------|----|------|---|---|--|---|-------------|
|  |                        | DC  | ZEFP | DCON | LF | APMX |   | Sıkma Vidası<br>Screw<br>Schraube           | Tork Anahtar<br>Torx Key<br>Torx-Schlüssel | Montaj Vidası<br>Mounting Screw<br>Befestigungsschraube |             |
| AFM66-PN0905-D050-A22-Z05                          | ●                      | 50  | 5    | 22   | 40 | 8    | PNMU 0905..                               |   |  |   |             |
| AFM66-PN0905-D063-A22-Z06                          | ●                      | 63  | 6    | 22   | 40 | 8    |   |   |  |   | 2508-M10x30 |
| AFM66-PN0905-D080-A27-Z08                          | ●                      | 80  | 8    | 27   | 50 | 8    |   |   |  |   | 2510-M12x35 |
| AFM66-PN0905-D100-A32-Z10                          | ●                      | 100   | 10   | 32   | 50 | 8    |   |   |  |   | 2514-M16x35 |
| AFM66-PN0905-D125-B40-Z12                          | ●                      | 125   | 12   | 40   | 63 | 8    |   |   |  |   | -           |

R: Sağ / Right / Rechts L: Sol / Left / Links

● Stokta / In Stock / Auf Lager ○ Stokta Yok / Non Stock Item / Kein Lagerartikel, Lieferzeit auf Anfrage  
KYCR Ucuna Uygunudur. / Compatible with KYCR Insert. / Kompatibel mit KYCR Wendeplatten.

Sipariş Örneği/Ordering Example/Bestellbeispiel

1 ad./pcs./stück AFM45-SN1306-D050-A22-Z05-H

Kesme Hesabı : S 377 / Cutting Calculation : P 377 / Schnittberechnung : P 377

Montaj Ölçüleri : S 374/ Mounting Reference : P 374 / Montagehinweis : P374

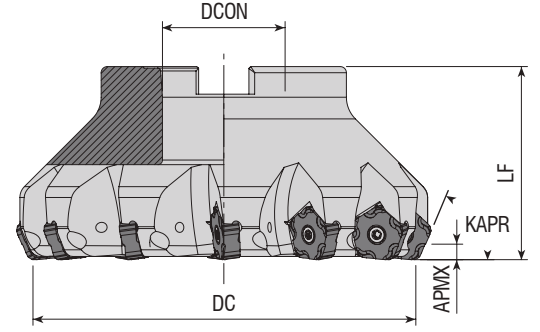

| Takım Kodu<br>Ordering Code<br>Bestell-Bezeichnung | Stok<br>Stock<br>Lager | Takım Ölçüleri (mm)<br>Dimension (mm)<br>Abmessung (mm) |      |      |    |      | Kesici Uç<br>Insert<br>Wendeschneidplatte | Yedek Parçaları / Spare Parts / Ersatzteile |  |   |
|--|------------------------|---|------|------|----|------|---|---|--|---|
|  |                        | DC  | ZEFP | DCON | LF | APMX |   | Sıkma Vidası<br>Screw<br>Schraube           | Tork Anahtar<br>Torx Key<br>Torx-Schlüssel | Montaj Vidası<br>Mounting Screw<br>Befestigungsschraube |
| AFM67-PN1105-D050-A22-Z05                          | ●                      | 50  | 5    | 22   | 50 | 5    | PNEG 1105..                               | 4015-M4x11                                  | 80-T15                                     | 2508-M10x30   |
| AFM67-PN1105-D063-A22-Z06                          | ●                      | 63  | 6    | 22   | 50 | 5    |   |   |  |   |
| AFM67-PN1105-D080-A27-Z08                          | ●                      | 80  | 8    | 27   | 50 | 5    |   |   |  |   |
| AFM67-PN1105-D100-B32-Z10                          | ●                      | 100   | 10   | 32   | 50 | 5    |   |   |  |   |
| AFM67-PN1105-D125-B40-Z12                          | ●                      | 125   | 12   | 40   | 63 | 5    |   |   |  |   |
| AFM67-PN1105-D160-C40-Z14                          | ●                      | 160   | 14   | 40   | 63 | 5    |   |   |  |   |

ZCC Ucuna Uygunur. / Compatible with ZCC Insert. / Kompatibel mit ZCC Wendeplatten.

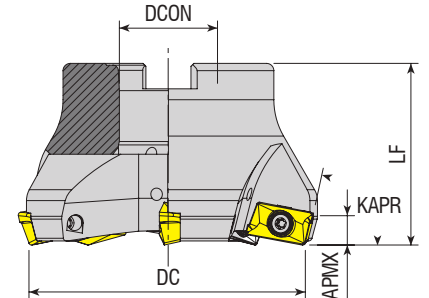

| Takım Kodu<br>Ordering Code<br>Bestell-Bezeichnung | Stok<br>Stock<br>Lager | Takım Ölçüleri (mm)<br>Dimension (mm)<br>Abmessung (mm) |      |      |    |      | Kesici Uç<br>Insert<br>Wendeschneidplatte | Yedek Parçaları / Spare Parts / Ersatzteile |  |   |
|--|------------------------|---|------|------|----|------|---|---|--|---|
|  |                        | DC  | ZEFP | DCON | LF | APMX |   | Sıkma Vidası<br>Screw<br>Schraube           | Tork Anahtar<br>Torx Key<br>Torx-Schlüssel | Montaj Vidası<br>Mounting Screw<br>Befestigungsschraube |
| AFM75-AP16-D063-A22-Z04-H                          | ●                      | 63  | 4    | 22   | 40 | 6    | AP. 1604..                                | 4015-M4x11                                  | 80-T15                                     | 2508-M10x30   |
| AFM75-AP16-D080-A27-Z05-H                          | ●                      | 80  | 5    | 27   | 50 | 6    |   |   |  | 2510-M12x35   |
| AFM75-AP16-D100-A32-Z06-H                          | ●                      | 100   | 6    | 32   | 50 | 6    |   |   |  | 2514-M16x35   |
| AFM75-AP16-D125-B40-Z07                            | ●                      | 125   | 7    | 40   | 63 | 6    |   |   |  | -   |

ISO Ucuna Uygunur. / Compatible with ISO Insert. / Kompatibel mit ISO Wendeplatten.

R: Sağ / Right / Rechts L: Sol / Left / Links

● Stokta / In Stock / Auf Lager ○ Stokta Yok / Non Stock Item / Kein Lagerartikel, Lieferzeit auf Anfrage

Sipariş Örneği/Ordering Example/Bestellbeispiel

1 ad./pcs./stück AFM67-PN1105-D050-A22-Z05

Kesme Hesabı : S 377 / Cutting Calculation : P 377 / Schnittberechnung : P 377

Montaj Ölçüleri : S 374 / Mounting Reference : P 374 / Montagehinweis : P374

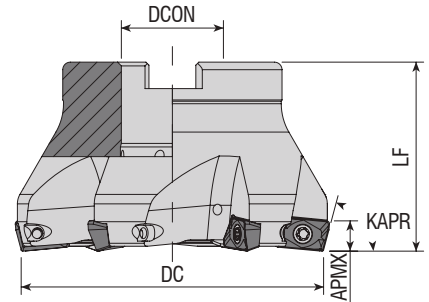

| Takım Kodu<br>Ordering Code<br>Bestell-Bezeichnung | Stok<br>Stock<br>Lager | Takım Ölçüleri (mm)<br>Dimension (mm)<br>Abmessung (mm) |      |      |    |      | Kesici Uç<br>Insert<br>Wendeschneidplatte | Yedek Parçaları / Spare Parts / Ersatzteile |  |   |
|--|------------------------|---|------|------|----|------|---|---|--|---|
|  |                        | DC  | ZEPF | DCON | LF | APMX |   | Sıkma Vidası<br>Screw<br>Schraube           | Tork Anahtar<br>Torx Key<br>Torx-Schlüssel | Montaj Vidası<br>Mounting Screw<br>Befestigungsschraube |
| AFM75-XO12-D050-A22-Z04-H                          | ●                      | 50  | 4    | 22   | 40 | -    | XO.. 1204..                               | 3010-M3.5x9                                 | 82-T10                                     | 2508-M10x30   |
| AFM75-XO12-D063-A22-Z05-H                          | ●                      | 63  | 5    | 22   | 40 | -    |   |   |  |   |
| AFM75-XO12-D080-A27-Z06-H                          | ●                      | 80  | 6    | 27   | 50 | -    |   |   |  | 2510-M12x35   |

SC Ucuna Uygunur. / Compatible with SC Insert. / Kompatibel mit SC Wendeplatten.

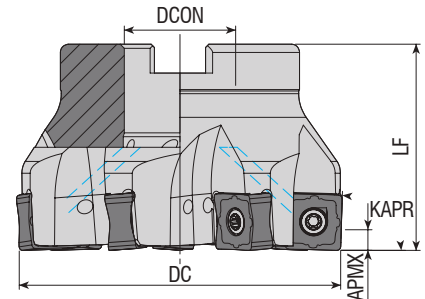

| Takım Kodu<br>Ordering Code<br>Bestell-Bezeichnung | Stok<br>Stock<br>Lager | Takım Ölçüleri (mm)<br>Dimension (mm)<br>Abmessung (mm) |      |      |    |      | Kesici Uç<br>Insert<br>Wendeschneidplatte | Yedek Parçaları / Spare Parts / Ersatzteile |  |   |
|--|------------------------|---|------|------|----|------|---|---|--|---|
|  |                        | DC  | ZEPF | DCON | LF | APMX |   | Sıkma Vidası<br>Screw<br>Schraube           | Tork Anahtar<br>Torx Key<br>Torx-Schlüssel | Montaj Vidası<br>Mounting Screw<br>Befestigungsschraube |
| AFM88-SN1305-D050-A22-Z04                          | ●                      | 50  | 4    | 22   | 40 | 5    | SNMU 1305..                               | 4015-M4x11                                  | 80-T15                                     | 2508-M10x30   |
| AFM88-SN1305-D050-A22-Z05                          | ●                      | 50  | 5    | 22   | 40 | 5    |   |   |  |   |
| AFM88-SN1305-D063-A22-Z05                          | ●                      | 63  | 5    | 22   | 40 | 5    |   |   |  |   |
| new AFM88L-SN1305-D063-A22-Z07                     | ●                      | 63  | 7    | 22   | 40 | 5    |   |   |  |   |
| AFM88-SN1305-D063-A22-Z07                          | ●                      | 63  | 7    | 22   | 40 | 5    |   |   |  |   |
| AFM88-SN1305-D080-A27-Z06                          | ●                      | 80  | 6    | 27   | 50 | 5    |   |   |  |   |
| AFM88-SN1305-D080-A27-Z09                          | ●                      | 80  | 9    | 27   | 50 | 5    |   |   |  |   |
| AFM88-SN1305-D100-A32-Z07                          | ●                      | 100   | 7    | 32   | 50 | 5    |   |   |  |   |
| AFM88-SN1305-D100-A32-Z11                          | ●                      | 100   | 11   | 32   | 50 | 5    |   |   |  |   |
| AFM88-SN1305-D125-B40-Z13                          | ●                      | 125   | 13   | 40   | 63 | 5    |   |   |  | 2510-M12x35   |

R: Sağ / Right / Rechts L: Sol / Left / Links

● Stokta / In Stock / Auf Lager ○ Stokta Yok / Non Stock Item / Kein Lagerartikel, Lieferzeit auf Anfrage  
KYCR Ucuna Uygunur. / Compatible with KYCR Insert. / Kompatibel mit KYCR Wendeplatten.

Sipariş Örneği/Ordering Example/Bestellbeispiel

1 ad./pcs./stück AFM75-XO12-D050-A22-Z04-H

Kesme Hesabı : S 377 / Cutting Calculation : P 377 / Schnittberechnung : P 377

Montaj Ölçüleri : S 374 / Mounting Reference : P 374 / Montagehinweis : P 374

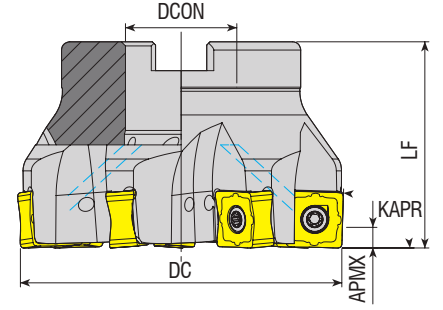

| Takım Kodu<br>Ordering Code<br>Bestell-Bezeichnung | Stok<br>Stock<br>Lager | Takım Ölçüleri (mm)<br>Dimension (mm)<br>Abmessung (mm) |      |      |    |      | Kesici Uç<br>Insert<br>Wendeschneidplatte | Yedek Parçaları / Spare Parts / Ersatzteile |  |   |            |        |             |
|--|------------------------|---|------|------|----|------|---|---|--|---|------------|--------|-------------|
|  |                        | DC  | ZEFP | DCON | LF | APMX |   | Sıkma Vidası<br>Screw<br>Schraube           | Tork Anahtar<br>Torx Key<br>Torx-Schlüssel | Montaj Vidası<br>Mounting Screw<br>Befestigungsschraube |            |        |             |
| AFM88-SN1306-D050-A22-Z05-H                        | ●                      | 50  | 5    | 22   | 40 | 12   | SNGX 1306..                               |   |  |   |            |        |             |
| AFM88-SN1306-D063-A22-Z06-H                        | ●                      | 63  | 6    | 22   | 40 | 12   |   |   |  |   | 1115-M4x10 | 80-T15 | 2508-M10x30 |
| AFM88-SN1306-D080-A27-Z07-H                        | ●                      | 80  | 7    | 27   | 50 | 12   |   |   |  |   |            |        | 2510-M12x35 |

TGTC Ucuna Uygunur. / Compatible with TGTC Insert. / Kompatibel mit TGTC Wendepplatten.

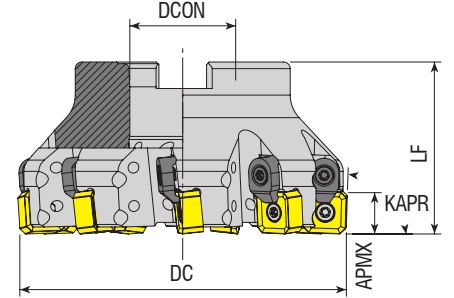

| Takım Kodu<br>Ordering Code<br>Bestell-Bezeichnung | Stok<br>Stock<br>Lager | Takım Ölçüleri (mm)<br>Dimension (mm)<br>Abmessung (mm) |      |      |    |      | Kesici Uç<br>Insert<br>Wendeschneidplatte | Yedek Parçaları / Spare Parts / Ersatzteile |   |  |  |   |            |             |
|--|------------------------|---|------|------|----|------|---|---|---|--|--|---|------------|-------------|
|  |                        | DC  | ZEFP | DCON | LF | APMX |   | Sıkma Vidası<br>Screw<br>Schraube           | Baskı Parçası<br>Wedge Clamp<br>Spannpratze | Baskı Vidası<br>Clamp Screw<br>Klemmschraube | Tork Anahtar<br>Torx Key<br>Torx-Schlüssel | Montaj Vidası<br>Mounting Screw<br>Befestigungsschraube |            |             |
| <b>new</b> AFM88C-SN1206-D040-A16-Z04-H            | ●                      | 40  | 4    | 16   | 40 | 11.5 | SN.. 1206..                               |   |   |  |  |   |            |             |
| AFM88C-SN1206-D050-A22-Z05-H                       | ●                      | 50  | 5    | 22   | 40 | 11.5 |   |   |   |  |  |   | 4015-M4x11 | 2506-M8x30  |
| AFM88C-SN1206-D063-A22-Z06-H                       | ●                      | 63  | 6    | 22   | 40 | 11.5 |   |   |   |  |  |   | 4615-M4x11 | 2508-M10x30 |
| AFM88C-SN1206-D080-A27-Z07-H                       | ●                      | 80  | 7    | 27   | 50 | 11.5 |   |   |   |  |  |   | 4015-M4x11 | 2510-M12x35 |
| AFM88C-SN1206-D100-A32-Z09-H                       | ●                      | 100   | 9    | 32   | 52 | 11.5 |   |   |   |  |  |   |            | 2514-M16x35 |
| <b>new</b> AFM88C-SN1206-D125-B40-Z10              | ●                      | 125   | 10   | 40   | 63 | 11.5 |   |   |   |  |  |   | 1015-M4x11 | 2506-M8x30  |

R: Sağ / Right / Rechts L: Sol / Left / Links

● Stokta / In Stock / Auf Lager ○ Stokta Yok / Non Stock Item / Kein Lagerartikel, Lieferzeit auf Anfrage

KRLY Ucuna Uygunur. / Compatible with KRLY Insert. / Kompatibel mit KRLY Wendepplatten.

Sipariş Örneği/Ordering Example/Bestellbeispiel

1 ad./pcs./stück AFM88-SN1306-D050-A22-Z05-H

Kesme Hesabı : S 377 / Cutting Calculation : P 377 / Schnittberechnung : P 377

Montaj Ölçüleri : S 374 / Mounting Reference : P 374 / Montagehinweis : P374

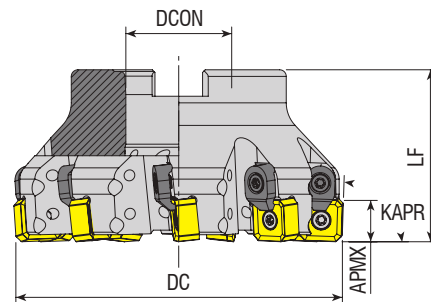

| Takım Kodu<br>Ordering Code<br>Bestell-Bezeichnung | Stok<br>Stock<br>Lager | Takım Ölçüleri (mm)<br>Dimension (mm)<br>Abmessung (mm) |      |      |    |      | Kesici Uç<br>Insert<br>Wendeschneidplatte | Yedek Parçaları / Spare Parts / Ersatzteile |   |  |  |   |
|--|------------------------|---|------|------|----|------|---|---|---|--|--|---|
|  |                        | DC  | ZEFP | DCON | LF | APMX |   | Sıkma Vidası<br>Screw<br>Schraube           | Baskı Parçası<br>Wedge Clamp<br>Spannpratze | Baskı Vidası<br>Clamp Screw<br>Klemmschraube | Tork Anahtar<br>Torx Key<br>Torx-Schlüssel | Montaj Vidası<br>Mounting Screw<br>Befestigungsschraube |
| AFM88C-SN12..-D050-A22-Z05-H                       | ●                      | 50  | 5    | 22   | 40 | 11.5 | SN.. 12..                                 | 1015-M4x11                                  | ACK-05                                      | 4015-M4x11                                   | 80-T15                                     | 2508-M10x30<br>2510-M12x35<br>2514-M16x35               |
| AFM88C-SN12..-D063-A22-Z06-H                       | ●                      | 63  | 6    | 22   | 40 | 11.5 |   |   |   |  |  |   |
| AFM88C-SN12..-D080-A27-Z07-H                       | ●                      | 80  | 7    | 27   | 50 | 11.5 |   |   |   |  |  |   |
| AFM88C-SN12..-D100-A32-Z09-H                       | ●                      | 100   | 9    | 32   | 52 | 11.5 |   |   |   |  |  |   |

ISO Ucuna Uygundur. / Compatible with ISO Insert. / Kompatibel mit ISO Wendepalten.

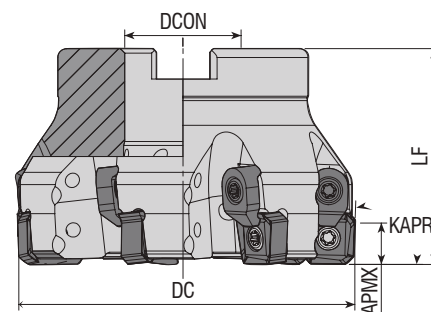

| Takım Kodu<br>Ordering Code<br>Bestell-Bezeichnung | Stok<br>Stock<br>Lager | Takım Ölçüleri (mm)<br>Dimension (mm)<br>Abmessung (mm) |      |      |    |      | Kesici Uç<br>Insert<br>Wendeschneidplatte | Yedek Parçaları / Spare Parts / Ersatzteile |   |  |  |   |
|--|------------------------|---|------|------|----|------|---|---|---|--|--|---|
|  |                        | DC  | ZEFP | DCON | LF | APMX |   | Sıkma Vidası<br>Screw<br>Schraube           | Baskı Parçası<br>Wedge Clamp<br>Spannpratze | Baskı Vidası<br>Clamp Screw<br>Klemmschraube | Tork Anahtar<br>Torx Key<br>Torx-Schlüssel | Montaj Vidası<br>Mounting Screw<br>Befestigungsschraube |
| AFM88C-SN12Z-D063-A22-Z06-H                        | ●                      | 63  | 6    | 22   | 40 | 11.5 | SNEG 1205..                               | 4015-M4x11                                  | ACK-05                                      | 4015-M4x11                                   | 80-T15                                     | 2508-M10x30<br>2510-M12x35                              |
| AFM88C-SN12Z-D080-A27-Z07-H                        | ●                      | 80  | 7    | 27   | 50 | 11.5 |   |   |   |  |  |   |

R: Sağ / Right / Rechts L: Sol / Left / Links

● Stokta / In Stock / Auf Lager ○ Stokta Yok / Non Stock Item / Kein Lagerartikel, Lieferzeit auf Anfrage

ZCC Ucuna Uygundur. / Compatible with ZCC Insert. / Kompatibel mit ZCC Wendepalten.

Sipariş Örneği/Ordering Example/Bestellbeispiel

1 ad./pcs./stück AFM88C-SN12..-D050-A22-Z05-H

Kesme Hesabı : S 377 / Cutting Calculation : P 377 / Schnittberechnung : P 377

Montaj Ölçüleri : S 374 / Mounting Reference : P 374 / Montagehinweis : P374

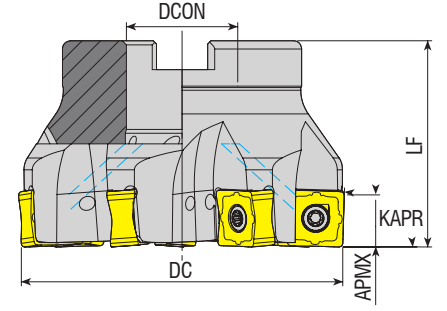

| Takım Kodu<br>Ordering Code<br>Bestell-Bezeichnung | Stok<br>Stock<br>Lager | Takım Ölçüleri (mm)<br>Dimension (mm)<br>Abmessung (mm) |      |      |    |      | Kesici Uç<br>Insert<br>Wendeschneidplatte | Yedek Parçaları / Spare Parts / Ersatzteile |   |  |  |   |
|--|------------------------|---|------|------|----|------|---|---|---|--|--|---|
|  |                        | DC  | ZEFP | DCON | LF | APMX |   | Sıkma Vidası<br>Screw<br>Schraube           | Baskı Parçası<br>Wedge Clamp<br>Spannpratze | Baskı Vidası<br>Clamp Screw<br>Klemmschraube | Tork Anahtar<br>Torx Key<br>Torx-Schlüssel | Montaj Vidası<br>Mounting Screw<br>Befestigungsschraube |
| AFM89-SN1305I-D040-A16-Z04-H                       | ●                      | 40  | 4    | 16   | 40 | 10   | SNMU 1305..                               | 1015 M4x11                                  | -   | -  | 80-T15                                     | 2306-M8x37  |
| AFM89-SN1305I-D050-A22-Z05-H                       | ●                      | 50  | 5    | 22   | 40 | 10   |   |   |   |  |  |   |
| AFM89-SN1305I-D063-A22-Z06-H                       | ●                      | 63  | 6    | 22   | 40 | 10   | SNMU 1305..                               |   |   |  |  |   |
| AFM89-SN1305I-D063-A22-Z07-H                       | ●                      | 63  | 7    | 22   | 40 | 10   |   |   |   |  |  |   |
| AFM89-SN1305I-D080-A27-Z08-H                       | ●                      | 80  | 8    | 27   | 50 | 10   | OXMT 0507..                               |   |   |  |  |   |
| AFM89-SN1305I-D100-A32-Z10-H                       | ●                      | 100   | 10   | 32   | 50 | 10   |   |   |   |  |  |   |

ISCR Ucuna Uygundur. / Compatible with ISCR Insert. / Kompatibel mit ISCR Wendepalten.

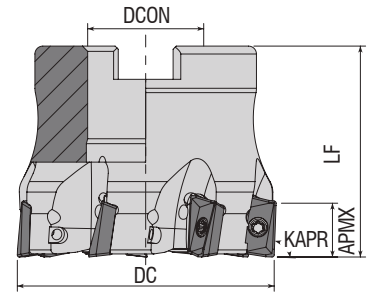

| Takım Kodu<br>Ordering Code<br>Bestell-Bezeichnung | Stok<br>Stock<br>Lager | Takım Ölçüleri (mm)<br>Dimension (mm)<br>Abmessung (mm) |      |      |    |      | Kesici Uç<br>Insert<br>Wendeschneidplatte | Yedek Parçaları / Spare Parts / Ersatzteile |  |   |
|--|------------------------|---|------|------|----|------|---|---|--|---|
|  |                        | DC  | ZEFP | DCON | LF | APMX |   | Sıkma Vidası<br>Screw<br>Schraube           | Tork Anahtar<br>Torx Key<br>Torx-Schlüssel | Montaj Vidası<br>Mounting Screw<br>Befestigungsschraube |
| AFM90-AD10T3-D040-A16-Z06-H                        | ●                      | 40  | 6    | 16   | 40 | 10   | ADMT 10T3..                               | 3008-M2.5x6                                 | 82-T08                                     | 2506-M8x30  |
| AFM90-AD10T3-D050-A22-Z07-H                        | ●                      | 50  | 7    | 22   | 40 | 10   |   |   |  | 2508-M10x30   |

R: Sağ / Right / Rechts L: Sol / Left / Links

● Stokta / In Stock / Auf Lager ○ Stokta Yok / Non Stock Item / Kein Lagerartikel, Lieferzeit auf Anfrage  
WLTR Ucuna Uygundur. / Compatible with WLTR Insert. / Kompatibel mit WLTR Wendepalten.

Sipariş Örneği/Ordering Example/Bestellbeispiel

1 ad./pcs./stück AFM89-SN1305I-D040-A16-Z04-H

Kesme Hesabı : S 367 / Cutting Calculation : P 367 / Schnittberechnung : P 367

Montaj Ölçüleri : S 364 / Mounting Reference : P 364 / Montagehinweis : P364



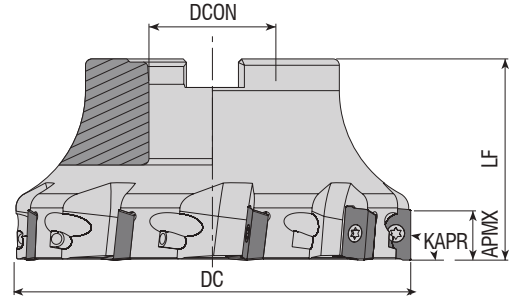

| Takım Kodu<br>Ordering Code<br>Bestell-Bezeichnung | Stok<br>Stock<br>Lager | Takım Ölçüleri (mm)<br>Dimension (mm)<br>Abmessung (mm) |      |      |    |      | Kesici Uç<br>Insert<br>Wendeschneidplatte | Yedek Parçaları / Spare Parts / Ersatzteile |  |   |
|--|------------------------|---|------|------|----|------|---|---|--|---|
|  |                        | DC  | ZEFP | DCON | LF | APMX |   | Sıkma Vidası<br>Screw<br>Schraube           | Tork Anahtar<br>Torx Key<br>Torx-Schlüssel | Montaj Vidası<br>Mounting Screw<br>Befestigungsschraube |
| AFM90-AD1505-D040-A16-Z04-H                        | ●                      | 40  | 4    | 16   | 40 | 14.3 | AD.. 1505..                               | 4015-M4x11                                  | 80-T15                                     | 2506-M8x30  |
| AFM90-AD1505-D050-A22-Z05-H                        | ●                      | 50  | 5    | 22   | 40 | 14.3 |   |   |  | 2508-M10x30   |
| AFM90-AD1505-D063-A22-Z06-H                        | ●                      | 63  | 6    | 22   | 40 | 14.3 |   |   |  | 2510-M12x35   |
| AFM90-AD1505-D080-A27-Z07-H                        | ●                      | 80  | 7    | 27   | 50 | 14.3 |   |   |  | 2514-M16x35   |
| AFM90-AD1505-D100-A32-Z08-H                        | ●                      | 100   | 8    | 32   | 50 | 14.3 |   |   |  | -   |
| AFM90-AD1505-D125-B40-Z09                          | ●                      | 125   | 9    | 40   | 63 | 14.3 |   |   |  | -   |

ISCR Ucuna Uygunur. / Compatible with ISCR Insert. / Kompatibel mit ISCR Wendeplatten.

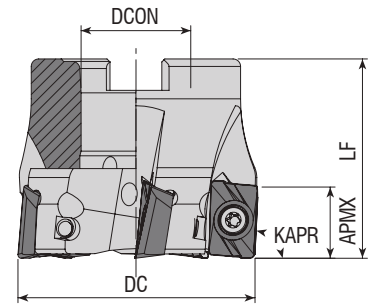

| Takım Kodu<br>Ordering Code<br>Bestell-Bezeichnung | Stok<br>Stock<br>Lager | Takım Ölçüleri (mm)<br>Dimension (mm)<br>Abmessung (mm) |      |      |    |      | Kesici Uç<br>Insert<br>Wendeschneidplatte | Yedek Parçaları / Spare Parts / Ersatzteile |  |   |
|--|------------------------|---|------|------|----|------|---|---|--|---|
|  |                        | DC  | ZEFP | DCON | LF | APMX |   | Sıkma Vidası<br>Screw<br>Schraube           | Tork Anahtar<br>Torx Key<br>Torx-Schlüssel | Montaj Vidası<br>Mounting Screw<br>Befestigungsschraube |
| AFM90-AD1505D-D050-A22-Z05-H                       | ●                      | 50  | 5    | 22   | 40 | 14.3 | ADKT 150508                               | 4015-M4x11                                  | 80-T15                                     | 2508-M10x30   |
| AFM90-AD1505D-D063-A27-Z06-H                       | ●                      | 63  | 6    | 27   | 50 | 14.3 |   |   |  | 2510-M12x35   |
| AFM90-AD1505D-D080-A27-Z08-H                       | ●                      | 80  | 8    | 27   | 50 | 14.3 |   |   |  | 2514-M16x35   |
| AFM90-AD1505D-D100-A32-Z08-H                       | ●                      | 100   | 8    | 32   | 50 | 14.3 |   |   |  | -   |
| AFM90-AD1505D-D125-B40-Z09                         | ●                      | 125   | 9    | 40   | 63 | 14.3 |   |   |  | -   |

R: Sağ / Right / Rechts L: Sol / Left / Links

● Stokta / In Stock / Auf Lager ○ Stokta Yok / Non Stock Item / Kein Lagerartikel, Lieferzeit auf Anfrage  
DJT Ucuna Uygunur. / Compatible with DJT Insert. / Kompatibel mit DJT Wendeplatten.

Sipariş Örneği/Ordering Example/Bestellbeispiel

1 ad./pcs./stück AFM90-AD1505-D040-A16-Z04-H

Kesme Hesabı : S 377 / Cutting Calculation : P 377 / Schnittberechnung : P 377

Montaj Ölçüleri : S 374 / Mounting Reference : P 374 / Montagehinweis : P374

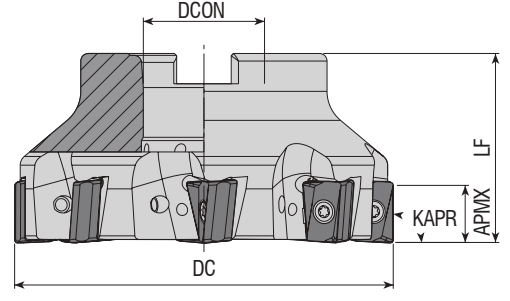

| Takım Kodu<br>Ordering Code<br>Bestell-Bezeichnung | Stok<br>Stock<br>Lager | Takım Ölçüleri (mm)<br>Dimension (mm)<br>Abmessung (mm) |      |      |    |      | Kesici Uç<br>Insert<br>Wendeschneidplatte | Yedek Parçaları / Spare Parts / Ersatzteile |  |   |
|--|------------------------|---|------|------|----|------|---|---|--|---|
|  |                        | DC  | ZEFP | DCON | LF | APMX |   | Sıkma Vidası<br>Screw<br>Schraube           | Tork Anahtar<br>Torx Key<br>Torx-Schlüssel | Montaj Vidası<br>Mounting Screw<br>Befestigungsschraube |
| AFM90-AN11-D040-A16-Z04-H                          | ●                      | 40  | 4    | 16   | 40 | 11   | ANGX 1105..                               | 4010-M3x8                                   | 82-T10                                     | 2506-M8x30  |
| AFM90-AN1506-D050-A22-Z04-H                        | ●                      | 50  | 4    | 22   | 40 | 14.5 |   |   |  | ANGX 1506..   |
| AFM90-AN1506-D063-A22-Z05-H                        | ●                      | 63  | 5    | 22   | 40 | 14.5 | 2510-M12x35                               |   |  |   |
| AFM90-AN1506-D080-A27-Z06-H                        | ●                      | 80  | 6    | 27   | 50 | 14.5 | 2514-M16x35                               |   |  |   |
| AFM90-AN1506-D100-A32-Z08-H                        | ●                      | 100   | 8    | 32   | 50 | 14.5 | -   |   |  |   |
| AFM90-AN1506-D125-B40-Z09                          | ●                      | 125   | 9    | 40   | 63 | 14.5 | -   |   |  |   |
| AFM90-AN1506-D160-C40-Z10                          | ●                      | 160   | 10   | 40   | 63 | 14.5 | -   |   |  |   |

ZCC Ucuna Uygundur. / Compatible with ZCC Insert. / Kompatibel mit ZCC Wendeplatten.

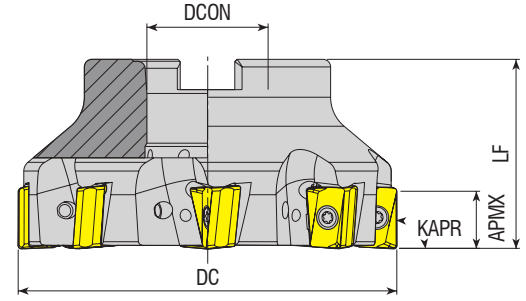

| Takım Kodu<br>Ordering Code<br>Bestell-Bezeichnung | Stok<br>Stock<br>Lager | Takım Ölçüleri (mm)<br>Dimension (mm)<br>Abmessung (mm) |      |      |    |      | Kesici Uç<br>Insert<br>Wendeschneidplatte | Yedek Parçaları / Spare Parts / Ersatzteile |  |   |
|--|------------------------|---|------|------|----|------|---|---|--|---|
|  |                        | DC  | ZEFP | DCON | LF | APMX |   | Sıkma Vidası<br>Screw<br>Schraube           | Tork Anahtar<br>Torx Key<br>Torx-Schlüssel | Montaj Vidası<br>Mounting Screw<br>Befestigungsschraube |
| AFM90-AN1607-D050-A22-Z04-H                        | ●                      | 50  | 4    | 22   | 40 | 15   | AN.X 1607..                               | 4015-M4x11                                  | 80-T15                                     | 2508-M10x30   |
| AFM90-AN1607-D063-A22-Z06-H                        | ●                      | 63  | 6    | 22   | 40 | 15   |   |   |  | 2510-M12x35   |
| AFM90-AN1607-D080-A27-Z07-H                        | ●                      | 80  | 7    | 27   | 50 | 15   |   |   |  | 2514-M16x35   |
| AFM90-AN1607-D100-A32-Z08-H                        | ●                      | 100   | 8    | 32   | 50 | 15   |   |   |  | -   |
| AFM90-AN1607-D125-B40-Z10                          | ●                      | 125   | 10   | 40   | 63 | 15   |   |   |  | -   |

R: Sağ / Right / Rechts L: Sol / Left / Links  
● Stokta / In Stock / Auf Lager ○ Stokta Yok / Non Stock Item / Kein Lagerartikel, Lieferzeit auf Anfrage  
TGTC Ucuna Uygundur. / Compatible with TGTC Insert. / Kompatibel mit TGTC Wendeplatten.

Sipariş Örneği/Ordering Example/Bestellbeispiel  
1 ad./pcs./stück AFM90-AN11-D040-A16-Z04-H  
Kesme Hesabı : S 377 / Cutting Calculation : P 377 / Schnittberechnung : P 377  
Montaj Ölçüleri : S 374 / Mounting Reference : P 374 / Montagehinweis : P 374

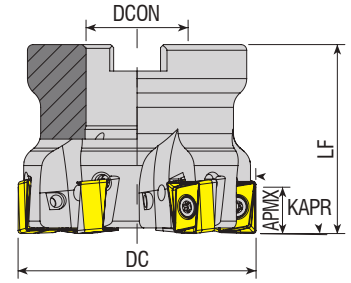

| Takım Kodu<br>Ordering Code<br>Bestell-Bezeichnung | Stok<br>Stock<br>Lager | Takım Ölçüleri (mm)<br>Dimension (mm)<br>Abmessung (mm) |      |      |    |      | Kesici Uç<br>Insert<br>Wendeschneidplatte | Yedek Parçaları / Spare Parts / Ersatzteile |  |   |
|--|------------------------|---|------|------|----|------|---|---|--|---|
|  |                        | DC  | ZEFP | DCON | LF | APMX |   | Sıkma Vidası<br>Screw<br>Schraube           | Tork Anahtar<br>Torx Key<br>Torx-Schlüssel | Montaj Vidası<br>Mounting Screw<br>Befestigungsschraube |
| AFM90-AN12-D040-A16-Z04-H                          | ●                      | 40  | 4    | 16   | 40 | 12   | ANKX 1205..                               | 4015-M4x12                                  | 80-T15                                     | 2406-M8x30  |
| AFM90-AN12-D050-A22-Z05-H                          | ●                      | 50  | 5    | 22   | 40 | 12   |   |   |  | 2508-M10x30   |
| AFM90-AN12-D063-A27-Z06-H                          | ●                      | 63  | 6    | 27   | 50 | 12   |   |   |  | 2510-M12x35   |

ISCR Ucuna Uygundur. / Compatible with ISCR Insert. / Kompatibel mit ISCR Wendeplatten.

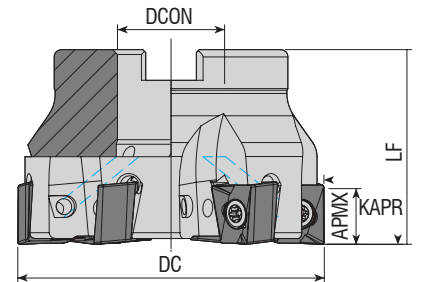

| Takım Kodu<br>Ordering Code<br>Bestell-Bezeichnung | Stok<br>Stock<br>Lager | Takım Ölçüleri (mm)<br>Dimension (mm)<br>Abmessung (mm) |      |      |    |      | Kesici Uç<br>Insert<br>Wendeschneidplatte | Yedek Parçaları / Spare Parts / Ersatzteile |  |   |
|--|------------------------|---|------|------|----|------|---|---|--|---|
|  |                        | DC  | ZEFP | DCON | LF | APMX |   | Sıkma Vidası<br>Screw<br>Schraube           | Tork Anahtar<br>Torx Key<br>Torx-Schlüssel | Montaj Vidası<br>Mounting Screw<br>Befestigungsschraube |
| AFM90-AN1207-D040-A16-Z04-H                        | ●                      | 40  | 4    | 16   | 40 | 10   | ANKX 1207..                               | 4015-M4x11                                  | 80-T15                                     | 2506-M8x30  |
| AFM90-AN1207-D050-A22-Z05-H                        | ●                      | 50  | 5    | 22   | 40 | 10   |   |   |  | 2508-M10x30   |
| AFM90-AN1207-D063-A22-Z06-H                        | ●                      | 63  | 6    | 22   | 40 | 10   |   |   |  | 2510-M12x35   |
| AFM90-AN1607X-D050-A22-Z04-H                       | ●                      | 50  | 4    | 22   | 40 | 15   | ANKX 1607..                               | 4015-M4x11                                  | 80-T15                                     | 2508-M10x30   |
| AFM90-AN1607X-D063-A22-Z06-H                       | ●                      | 63  | 6    | 22   | 40 | 15   |   |   |  | 2510-M12x35   |
| AFM90-AN1607X-D080-A27-Z07-H                       | ●                      | 80  | 7    | 27   | 50 | 15   |   |   |  | 2510-M12x35   |

R: Sağ / Right / Rechts L: Sol / Left / Links

● Stokta / In Stock / Auf Lager ○ Stokta Yok / Non Stock Item / Kein Lagerartikel, Lieferzeit auf Anfrage

XTC-GSC Ucuna Uygundur. / Compatible with XTC-GSC Insert. / Kompatibel mit XTC-GSC Wendeplatten.

Sipariş Örneği/Ordering Example/Bestellbeispiel

1 ad./pcs./stück AFM90-AN12-D040-A16-Z04-H

Kesme Hesabı : S 377 / Cutting Calculation : P 377 / Schnittberechnung : P 377

Montaj Ölçüleri : S 374 / Mounting Reference : P 374 / Montagehinweis : P374

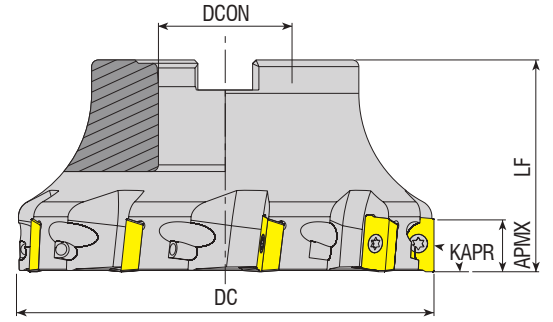

| Takım Kodu<br>Ordering Code<br>Bestell-Bezeichnung | Stok<br>Stock<br>Lager | Takım Ölçüleri (mm)<br>Dimension (mm)<br>Abmessung (mm) |      |      |    |      | Kesici Uç<br>Insert<br>Wendeschneidplatte   | Yedek Parçaları / Spare Parts / Ersatzteile |  |   |
|--|------------------------|---|------|------|----|------|---|---|--|---|
|  |                        | DC  | ZEFP | DCON | LF | APMX |   | Sıkma Vidası<br>Screw<br>Schraube           | Tork Anahtar<br>Torx Key<br>Torx-Schlüssel | Montaj Vidası<br>Mounting Screw<br>Befestigungsschraube                                     |
| • new AFM90-AP10-D040-A16-Z04-H                    | ●                      | 40  | 4    | 16   | 35 | 10   | AP. 1003..<br>ISO UCUNA<br>UYGUNDUR.<br>FOR ISO INSERT.<br>Kompatibel mit ISO Wendepfatten. | 3008-M2.5x6                                 | 82-T08                                     | 2506-M8x30  |
| AFM90-AP10-D040-A16-Z05-H                          | ●                      | 40  | 5    | 16   | 40 | 10   |   |   |  | 2508-M10x30   |
| AFM90-AP10-D050-A22-Z06-H                          | ●                      | 50  | 6    | 22   | 40 | 10   |   |   |  | 3008-M2.5x6   |
| • new AFM90-AP10-D050-A22-Z07-H                    | ●                      | 50  | 7    | 22   | 40 | 10   |   |   |  | 2508-M10x30   |
| • new AFM90-AP10-D063-A22-Z06                      | ●                      | 63  | 6    | 22   | 40 | 10   |   |   |  | 3008-M2.5x6   |
| AFM90-AP10-D063-A22-Z07-H                          | ●                      | 63  | 7    | 22   | 40 | 10   |   |   |  | 2510-M12x35   |
| • new AFM90-AP10-D063-A22-Z09                      | ●                      | 63  | 9    | 22   | 40 | 10   |   |   |  | 2514-M16x35   |
| AFM90-AP10-D080-A27-Z08-H                          | ●                      | 80  | 8    | 27   | 50 | 10   |   |   |  | 2506-M8x30  |
| AFM90-AP10-D100-A32-Z09-H                          | ●                      | 100   | 9    | 32   | 50 | 10   |   |   |  | 2508-M10x30   |
| AFM90-AP16-D040-A16-Z04-H                          | ●                      | 40  | 4    | 16   | 40 | 16   |   |   |  | AP. 1604..<br>ISO UCUNA<br>UYGUNDUR.<br>FOR ISO INSERT.<br>Kompatibel mit ISO Wendepfatten. |
| AFM90-AP16-D050-A22-Z05-H                          | ●                      | 50  | 5    | 22   | 40 | 16   | 2506-M8x30  |   |  |   |
| AFM90-AP16-D052-A22-Z05-H                          | ●                      | 52  | 5    | 22   | 40 | 16   | 2508-M10x30   |   |  |   |
| AFM90-AP16-D063-A22-Z06-H                          | ●                      | 63  | 6    | 22   | 40 | 16   | 2510-M12x35   |   |  |   |
| AFM90-AP16-D080-A27-Z07-H                          | ●                      | 80  | 7    | 27   | 50 | 16   | 2514-M16x35   |   |  |   |
| AFM90-AP16-D100-A32-Z08-H                          | ●                      | 100   | 8    | 32   | 50 | 16   | -   |   |  |   |
| AFM90-AP16-D125-B40-Z09                            | ●                      | 125   | 9    | 40   | 63 | 16   | 2508-M10x30   |   |  |   |
| AFM90-AP16-D160-C40-Z10                            | ●                      | 160   | 10   | 40   | 63 | 16   | 2510-M12x35   |   |  |   |
| AFM90-AP16-D200-C60-Z12                            | ●                      | 200   | 12   | 60   | 63 | 16   | 2514-M16x35   |   |  |   |
| AFM90-AP16DJ-D050-A22-Z05-H                        | ●                      | 50  | 5    | 22   | 40 | 16   | AP. 1604..<br>DJT UCUNA UYGUNDUR.<br>FOR DJT INSERT.<br>Kompatibel mit DJT                  | 4015-M4x11                                  | 80-T15                                     |   |
| AFM90-AP16DJ-D063-A22-Z06-H                        | ●                      | 63  | 6    | 22   | 40 | 16   |   |   |  | 2510-M12x35   |
| AFM90-AP16L-D050-A22-Z05-H                         | ●                      | 50  | 5    | 22   | 40 | 16   |   |   |  | 2508-M10x30   |
| AFM90-AP16L-D063-A22-Z06-H                         | ●                      | 63  | 6    | 22   | 40 | 16   |   |   |  | 2510-M12x35   |
| AFM90-AP16L-D080-A27-Z07-H                         | ●                      | 80  | 7    | 27   | 50 | 16   |   |   |  | 2506-M8x30  |
| AFM90-AP16P-D040-A16-Z04-H                         | ●                      | 40  | 4    | 16   | 40 | 16   |   |   |  | 2508-M10x30   |
| AFM90-AP16P-D050-A22-Z05-H                         | ●                      | 50  | 5    | 22   | 40 | 16   |   |   |  | 2510-M12x35   |
| AFM90-AP16P-D063-A22-Z06-H                         | ●                      | 63  | 6    | 22   | 40 | 16   |   |   |  | 2514-M16x35   |
| AFM90-AP16P-D080-A27-Z07-H                         | ●                      | 80  | 7    | 27   | 50 | 16   |   |   |  | 2508-M10x30   |
| AFM90-AP16P-D100-A32-Z08-H                         | ●                      | 100   | 8    | 32   | 50 | 16   |   |   |  | 2510-M12x35   |
| AFM90-AP16A-D050-A22-Z05-H                         | ●                      | 50  | 5    | 22   | 40 | 15   | AP. 1604..<br>ACHTK UCUNA<br>UYGUNDUR.<br>FOR ACHTK INSERT.<br>Kompatibel mit ACHTK         | 4015-M4x11                                  | 80-T15                                     | 2514-M16x35   |
| AFM90-AP16A-D063-A22-Z06-H                         | ●                      | 63  | 6    | 22   | 40 | 15   |   |   |  | -   |
| AFM90-AP16A-D080-A27-Z07-H                         | ●                      | 80  | 7    | 27   | 50 | 15   |   |   |  | 2506-M8x30  |
| AFM90-AP16A-D100-A32-Z08-H                         | ●                      | 100   | 8    | 32   | 50 | 15   |   |   |  | 2508-M10x30   |
| AFM90-AP16A-D125-B40-Z09                           | ●                      | 125   | 9    | 40   | 63 | 15   |   |   |  | 2510-M12x30   |
| AFM90-AP16Y-D040-A16-Z04-H                         | ●                      | 40  | 4    | 16   | 40 | 16   |   |   |  | 2510-M12x35   |
| AFM90-AP16Y-D050-A22-Z05-H                         | ●                      | 50  | 5    | 22   | 40 | 16   |   |   |  | 2514-M16x35   |
| AFM90-AP16Y-D063-A22-Z06-H                         | ●                      | 63  | 6    | 22   | 40 | 16   |   |   |  | 2506-M8x30  |
| AFM90-AP16Y-D080-A27-Z07-H                         | ●                      | 80  | 7    | 27   | 50 | 16   |   |   |  | 2508-M10x30   |
| AFM90-AP16Y-D100-A32-Z08-H                         | ●                      | 100   | 8    | 32   | 50 | 16   |   |   |  | 2510-M12x30   |

R: Sağ / Right / Rechts L: Sol / Left / Links

● Stokta / In Stock / Auf Lager ○ Stokta Yok / Non Stock Item / Kein Lagerartikel, Lieferzeit auf Anfrage

Sipariş Örneği/Ordering Example/Bestellbeispiel

1 ad./pcs./stück AFM90-AP10-D040-A16-Z04-H

Kesme Hesabı : S 377 / Cutting Calculation : P 377 / Schnittberechnung : P 377

Montaj Ölçüleri : S 374 / Mounting Reference : P 374 / Montagehinweis : P 374

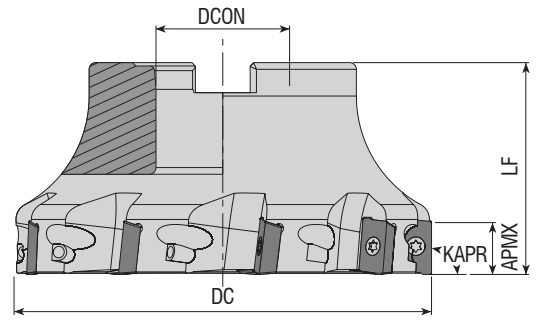

| Takım Kodu<br>Ordering Code<br>Bestell-Bezeichnung | Stok<br>Stock<br>Lager | Takım Ölçüleri (mm)<br>Dimension (mm)<br>Abmessung (mm) |      |      |    |      | Kesici Uç<br>Insert<br>Wendeschneidplatte | Yedek Parçaları / Spare Parts / Ersatzteile |  |   |
|--|------------------------|---|------|------|----|------|---|---|--|---|
|  |                        | DC  | ZEFP | DCON | LF | APMX |   | Sıkma Vidası<br>Screw<br>Schraube           | Tork Anahtar<br>Torx Key<br>Torx-Schlüssel | Montaj Vidası<br>Mounting Screw<br>Befestigungsschraube |
| AFM90-AP1705-D050-A22-Z05-H                        | ●                      | 50  | 5    | 22   | 40 | 16   | AP. 1705..                                | 4015-M4x11                                  | 80-T15                                     | 2508-M10x30   |
| AFM90-AP1705-D063-A22-Z06-H                        | ●                      | 63  | 6    | 22   | 40 | 16   |   |   |  | 2510-M12x35   |
| AFM90-AP1705-D080-A27-Z07-H                        | ●                      | 80  | 7    | 27   | 50 | 16   |   |   |  | 2514-M16x35   |
| AFM90-AP1705-D100-A32-Z08-H                        | ●                      | 100   | 8    | 32   | 50 | 16   |   |   |  |   |

TGTC Ucuna Uygun. / Compatible with TGTC Insert. / Kompatibel mit TGTC Wendeplatten.

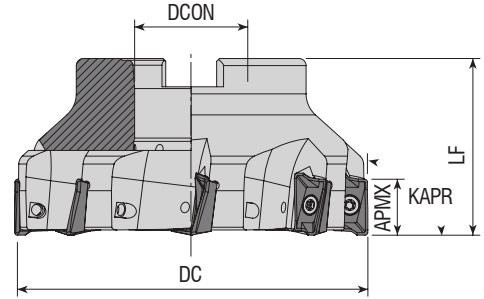

| Takım Kodu<br>Ordering Code<br>Bestell-Bezeichnung | Stok<br>Stock<br>Lager | Takım Ölçüleri (mm)<br>Dimension (mm)<br>Abmessung (mm) |      |      |    |      | Kesici Uç<br>Insert<br>Wendeschneidplatte | Yedek Parçaları / Spare Parts / Ersatzteile |  |   |
|--|------------------------|---|------|------|----|------|---|---|--|---|
|  |                        | DC  | ZEFP | DCON | LF | APMX |   | Sıkma Vidası<br>Screw<br>Schraube           | Tork Anahtar<br>Torx Key<br>Torx-Schlüssel | Montaj Vidası<br>Mounting Screw<br>Befestigungsschraube |
| AFM90-AX1235-D040-A16-Z06-H                        | ●                      | 40  | 6    | 16   | 40 | 10   | AX.T 1235..                               | 3108-M3x6                                   | 82-T08                                     | 2506-M8x30  |
| AFM90-AX1235-D050-A22-Z07-H                        | ●                      | 50  | 7    | 22   | 40 | 10   |   |   |  | 2508-M10x30   |
| AFM90-AX1235-D063-A22-Z08-H                        | ●                      | 63  | 8    | 22   | 40 | 10   |   |   |  | 2510-M12x35   |
| AFM90-AX1235-D080-A27-Z10-H                        | ●                      | 80  | 10   | 27   | 50 | 10   |   |   |  | 2514-M16x35   |
| AFM90-AX1705-D040-A16-Z04-H                        | ●                      | 40  | 4    | 16   | 40 | 14   | AX.T 1705..                               | 4015-M4x11                                  | 80-T15                                     | 2506-M8x30  |
| AFM90-AX1705-D050-A22-Z05-H                        | ●                      | 50  | 5    | 22   | 40 | 14   |   |   |  | 2508-M10x30   |
| AFM90-AX1705-D063-A22-Z06-H                        | ●                      | 63  | 6    | 22   | 40 | 14   |   |   |  | 2510-M12x35   |
| AFM90-AX1705-D080-A27-Z07-H                        | ●                      | 80  | 7    | 27   | 50 | 14   |   |   |  | 2514-M16x35   |
| AFM90-AX1705-D100-A32-Z08-H                        | ●                      | 100   | 8    | 32   | 50 | 14   |   |   |  |   |

R: Sağ / Right / Rechts L: Sol / Left / Links

● Stokta / In Stock / Auf Lager ○ Stokta Yok / Non Stock Item / Kein Lagerartikel, Lieferzeit auf Anfrage  
SMTM Ucuna Uygun. / Compatible with SMTM Insert. / Kompatibel mit SMTM Wendeplatten.

Sipariş Örneği/Ordering Example/Bestellbeispiel

1 ad./pcs./stück AFM90-AP1705-D050-A22-Z05-H

Kesme Hesabı : S 377 / Cutting Calculation : P 377 / Schnittberechnung : P 379

Montaj Ölçüleri : S 374 / Mounting Reference : P 374 / Montagehinweis : P374

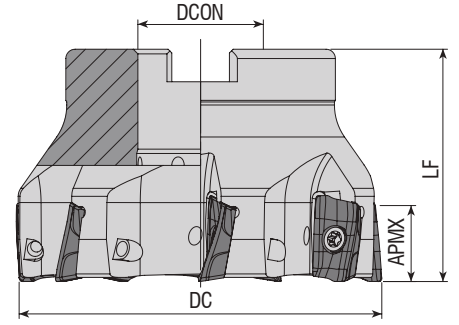

| Takım Kodu<br>Ordering Code<br>Bestell-Bezeichnung | Stok<br>Stock<br>Lager | Takım Ölçüleri (mm)<br>Dimension (mm)<br>Abmessung (mm) |      |      |    |      | Kesici Uç<br>Insert<br>Wendeschneidplatte | Yedek Parçaları / Spare Parts / Ersatzteile |  |   |
|--|------------------------|---|------|------|----|------|---|---|--|---|
|  |                        | DC  | ZEFP | DCON | LF | APMX |   | Sıkma Vidası<br>Screw<br>Schraube           | Tork Anahtar<br>Torx Key<br>Torx-Schlüssel | Montaj Vidası<br>Mounting Screw<br>Befestigungsschraube |
| AFM90-BD11T3-D040-A16-Z04-H                        | ●                      | 40  | 4    | 16   | 40 | 10   | BDMT 11T3..                               | 3008-M2.5x6                                 | 82-T08                                     | 2506-M8x30  |
| AFM90-BD11T3-D040-A16-Z05-H                        | ●                      | 40  | 5    | 16   | 40 | 10   |   |   |  |   |
| AFM90-BD11T3-D050-A22-Z05-H                        | ●                      | 50  | 5    | 22   | 40 | 10   |   |   |  |   |
| AFM90-BD11T3-D063-A22-Z06-H                        | ●                      | 63  | 6    | 22   | 40 | 10   |   |   |  |   |
| AFM90-BD1704-D050-A22-Z04-H                        | ●                      | 50  | 4    | 22   | 40 | 15.7 | BDMT 1704..                               | 4015-M4x11                                  | 80-T15                                     | 2508-M10x30   |
| AFM90-BD1704-D050-A22-Z05-H                        | ●                      | 50  | 5    | 22   | 40 | 15.7 |   |   |  |   |
| AFM90-BD1704-D063-A22-Z06-H                        | ●                      | 63  | 6    | 22   | 40 | 15.7 |   |   |  |   |
| AFM90-BD1704-D080-A27-Z06-H                        | ●                      | 80  | 6    | 27   | 50 | 15.7 |   |   |  |   |
| AFM90-BD1704-D080-A27-Z07-H                        | ●                      | 80  | 7    | 27   | 50 | 15.7 |   |   |  |   |
| AFM90-BD1704-D100-A32-Z07-H                        | ●                      | 100   | 7    | 32   | 50 | 15.7 |   |   |  |   |

KYCR Ucuna Uygun. / Compatible with KYCR Insert. / Kompatibel mit KYCR Wendeplatten.

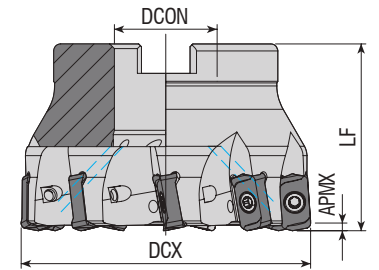

| Takım Kodu<br>Ordering Code<br>Bestell-Bezeichnung | Stok<br>Stock<br>Lager | Takım Ölçüleri (mm)<br>Dimension (mm)<br>Abmessung (mm) |      |      |    |      | Kesici Uç<br>Insert<br>Wendeschneidplatte | Yedek Parçaları / Spare Parts / Ersatzteile |  |   |
|--|------------------------|---|------|------|----|------|---|---|--|---|
|  |                        | DC  | ZEFP | DCON | LF | APMX |   | Sıkma Vidası<br>Screw<br>Schraube           | Tork Anahtar<br>Torx Key<br>Torx-Schlüssel | Montaj Vidası<br>Mounting Screw<br>Befestigungsschraube |
| AFM90-LO1004-D040-A16-Z05-H                        | ●                      | 40  | 5    | 16   | 40 | 10   | LOMU 1004..                               | 1108-M3x6.8                                 | 82-T08                                     | 2506-M8x30  |
| AFM90-LO1004-D050-A22-Z05-H                        | ●                      | 50  | 5    | 22   | 40 | 10   |   |   |  |   |
| AFM90-LO1004-D063-A22-Z06-H                        | ●                      | 63  | 6    | 22   | 40 | 10   |   |   |  |   |
| AFM90-LO1505-D050-A22-Z04-H                        | ●                      | 50  | 4    | 22   | 40 | 15   | LOMU 1505..                               | 3015-M4x11                                  | 80-T15                                     | 2508-M10x30   |
| AFM90-LO1505-D063-A22-Z05-H                        | ●                      | 63  | 5    | 22   | 40 | 15   |   |   |  |   |

R: Sağ / Right / Rechts L: Sol / Left / Links

● Stokta / In Stock / Auf Lager ○ Stokta Yok / Non Stock Item / Kein Lagerartikel, Lieferzeit auf Anfrage  
KYCR Ucuna Uygun. / Compatible with KYCR Insert. / Kompatibel mit KYCR Wendeplatten.

Sipariş Örneği/Ordering Example/Bestellbeispiel

1 ad./pcs./stück AFM90-BD11T3-D040-A16-Z04-H

Kesme Hesabı : S 377 / Cutting Calculation : P 377 / Schnittberechnung : P 377

Montaj Ölçüleri : S 374 / Mounting Reference : P 374 / Montagehinweis : P374

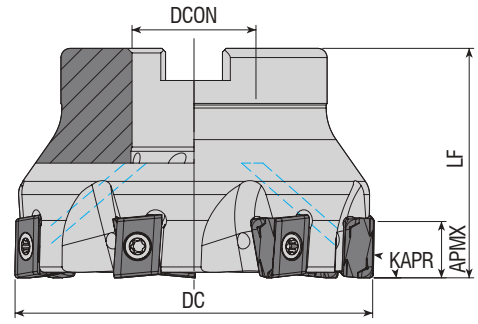

| Takım Kodu<br>Ordering Code<br>Bestell-Bezeichnung | Stok<br>Stock<br>Lager | Takım Ölçüleri (mm)<br>Dimension (mm)<br>Abmessung (mm) |      |      |    |      | Kesici Uç<br>Insert<br>Wendeschneidplatte | Yedek Parçaları / Spare Parts / Ersatzteile |  |   |
|--|------------------------|---|------|------|----|------|---|---|--|---|
|  |                        | DC  | ZEFP | DCON | LF | APMX |   | Sıkma Vidası<br>Screw<br>Schraube           | Tork Anahtar<br>Torx Key<br>Torx-Schlüssel | Montaj Vidası<br>Mounting Screw<br>Befestigungsschraube |
| AFM90-LN1506X-D063-A22-Z06                         | ●                      | 63  | 6    | 22   | 40 | 7    | LNMT 1506..                               | 3015-M4x11                                  | 80-T15                                     | 2508-M10x30   |
| AFM90-LN1506X-D080-A27-Z07                         | ●                      | 80  | 7    | 27   | 50 | 7    |   |   |  | 2510-M12x35   |
| AFM90-LN1506X-D100-A32-Z08                         | ●                      | 100   | 8    | 32   | 50 | 7    |   |   |  | 2514-M16x35   |

R: Sağ / Right / Rechts L: Sol / Left / Links

● Stokta / In Stock / Auf Lager ○ Stokta Yok / Non Stock Item / Kein Lagerartikel, Lieferzeit auf Anfrage

XTC-GSC Ucuna Uygundur. / Compatible with XTC-GSC Insert. / Kompatibel mit XTC-GSC Wendeplatten.

Kesme Hesabı : S 377 / Cutting Calculation : P 377 / Schnittberechnung : P 377

Montaj Ölçüleri : S 374 / Mounting Reference : P 374 / Montagehinweis : P374

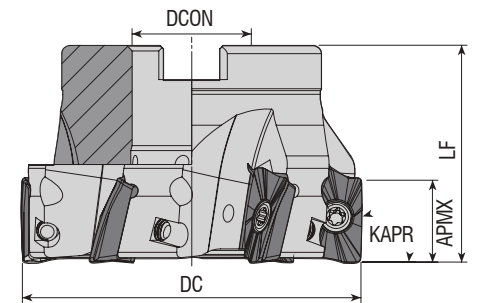

| Takım Kodu<br>Ordering Code<br>Bestell-Bezeichnung | Stok<br>Stock<br>Lager | Takım Ölçüleri (mm)<br>Dimension (mm)<br>Abmessung (mm) |      |      |    |      | Kesici Uç<br>Insert<br>Wendeschneidplatte | Yedek Parçaları / Spare Parts / Ersatzteile |  |   |
|--|------------------------|---|------|------|----|------|---|---|--|---|
|  |                        | DC  | ZEFP | DCON | LF | APMX |   | Sıkma Vidası<br>Screw<br>Schraube           | Tork Anahtar<br>Torx Key<br>Torx-Schlüssel | Montaj Vidası<br>Mounting Screw<br>Befestigungsschraube |
| AFM90-A01236-D050-A22-Z05-H                        | ●                      | 50  | 5    | 22   | 40 | 10   | AO.. 1236..                               | 3008-M2.5x6                                 | 82-T08                                     | 2508-M10x30   |
| AFM90-A01848-D050-A22-Z05-H                        | ●                      | 50  | 5    | 22   | 40 | 15   | AO.. 1848..                               | 4015-M4x11                                  | 80-T15                                     |   |
| AFM90-A01848-D063-A22-Z06-H                        | ●                      | 63  | 6    | 22   | 40 | 15   |   |   |  |   |

MTSBH Ucuna Uygundur. / Compatible with MTSBH Insert. / Kompatibel mit MTSBH Wendeplatten.

Sipariş Örneği/Ordering Example/Bestellbeispiel

1 ad./pcs./stück AFM90-LN1506X-D063-A22-Z06

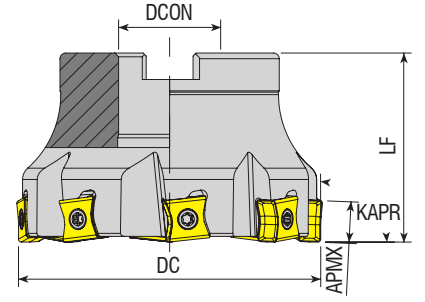

| Takım Kodu<br>Ordering Code<br>Bestell-Bezeichnung | Stok<br>Stock<br>Lager | Takım Ölçüleri (mm)<br>Dimension (mm)<br>Abmessung (mm) |      |      |    |      | Kesici Uç<br>Insert<br>Wendeschneidplatte | Yedek Parçaları / Spare Parts / Ersatzteile |  |   |
|--|------------------------|---|------|------|----|------|---|---|--|---|
|  |                        | DC  | ZEFP | DCON | LF | APMX |   | Sıkma Vidası<br>Screw<br>Schraube           | Tork Anahtar<br>Torx Key<br>Torx-Schlüssel | Montaj Vidası<br>Mounting Screw<br>Befestigungsschraube |
| AFM90-LN1106-D050-A22-Z05                          | ●                      | 50  | 5    | 22   | 40 | 10   | LNMT 1106..                               | 4015-M3.5x11                                | 80-T15                                     | 2508-M10x30   |
| AFM90-LN1106-D063-A22-Z06                          | ●                      | 63  | 6    | 22   | 40 | 10   |   |   |  | 2510-M12x35   |
| AFM90-LN1106-D080-A27-Z08                          | ●                      | 80  | 8    | 27   | 50 | 10   |   |   |  | 2514-M16x35   |
| AFM90L-LN1106-D080-A27-Z08                         | ●                      | 80  | 8    | 27   | 50 | 10   |   |   |  | -   |
| AFM90-LN1106-D100-A32-Z09                          | ●                      | 100   | 9    | 32   | 50 | 10   |   |   |  | 2506-M8x30  |
| AFM90L-LN1106-D100-A32-Z09                         | ●                      | 100   | 9    | 32   | 50 | 10   |   |   |  | 2508-M10x30   |
| AFM90-LN1106-D125-B40-Z10                          | ●                      | 125   | 10   | 40   | 63 | 10   |   |   |  | 2510-M12x35   |
| AFM90-LN1306-D040-A16-Z04-H                        | ●                      | 40  | 4    | 16   | 40 | 12.5 | T490 LNMT 1306..                          | 4015-M4x11                                  | 80-T15                                     | 2514-M16x35   |
| AFM90-LN1306-D050-A22-Z05-H                        | ●                      | 50  | 5    | 22   | 40 | 12.5 |   |   |  | 2506-M8x30  |
| AFM90-LN1306-D063-A22-Z06-H                        | ●                      | 63  | 6    | 22   | 40 | 12.5 |   |   |  | 2508-M10x30   |
| AFM90-LN1306-D080-A27-Z07-H                        | ●                      | 80  | 7    | 27   | 50 | 12.5 |   |   |  | 2510-M12x35   |
| AFM90-LN1306-D100-A32-Z08-H                        | ●                      | 100   | 8    | 32   | 50 | 12.5 | LNMT 1506..                               | 4015-M4x11                                  | 80-T20                                     | 2514-M16x35   |
| AFM90L-LN1506-D040-A16-Z04                         | ●                      | 40  | 4    | 16   | 40 | 14   |   |   |  | 2506-M8x30  |
| AFM90-LN1506-D040-A16-Z04                          | ○                      | 40  | 4    | 16   | 40 | 14   |   |   |  | 2508-M10x30   |
| AFM90-LN1506-D050-A22-Z05                          | ○                      | 50  | 5    | 22   | 40 | 14   |   |   |  | 2510-M12x35   |
| AFM90-LN1506-D063-A22-Z06                          | ○                      | 63  | 6    | 22   | 40 | 14   |   |   |  | 2514-M16x35   |
| AFM90-LN1506-D080-A27-Z07                          | ○                      | 80  | 7    | 27   | 50 | 14   |   |   |  | 2508-M10x30   |
| AFM90-LN1607-D050-A22-Z03-H                        | ●                      | 50  | 3    | 22   | 40 | 16   | T490 LNHT 1607..                          | 4420-M5x14                                  | 80-T20                                     | 2510-M12x35   |
| AFM90-LN1607-D063-A22-Z04-H                        | ○                      | 63  | 4    | 22   | 40 | 16   |   |   |  | 2514-M16x35   |
| AFM90-LN1607-D080-A27-Z05-H                        | ●                      | 80  | 5    | 27   | 50 | 16   |   |   |  |   |
| AFM90-LN1607-D100-A32-Z06-H                        | ●                      | 100   | 6    | 32   | 50 | 16   |   |   |  |   |

R: Sağ / Right / Rechts L: Sol / Left / Links

● Stokta / In Stock / Auf Lager ○ Stokta Yok / Non Stock Item / Kein Lagerartikel, Lieferzeit auf Anfrage  
ISCR Ucuna Uygunudur. / Compatible with ISCR Insert. / Kompatibel mit ISCR Wendepfatten.

Sipariş Örneği/Ordering Example/Bestellbeispiel

1 ad./pcs./stück AFM90-LN1106-D050-A22-Z05

Kesme Hesabı : S 377 / Cutting Calculation : P 377 / Schnittberechnung : P 377

Montaj Ölçüleri : S 374 / Mounting Reference : P 374 / Montagehinweis : P374



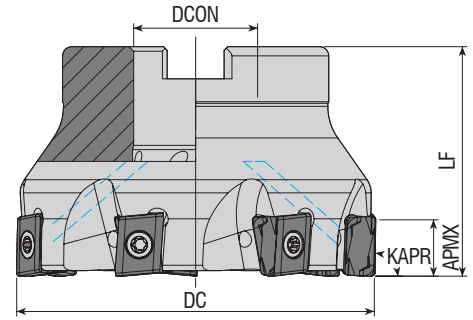

| Takım Kodu<br>Ordering Code<br>Bestell-Bezeichnung | Stok<br>Stock<br>Lager | Takım Ölçüleri (mm)<br>Dimension (mm)<br>Abmessung (mm) |      |      |    |      | Kesici Uç<br>Insert<br>Wendeschneidplatte | Yedek Parçaları / Spare Parts / Ersatzteile |  |   |
|--|------------------------|---|------|------|----|------|---|---|--|---|
|  |                        | DC  | ZEFP | DCON | LF | APMX |   | Sıkma Vidası<br>Screw<br>Schraube           | Tork Anahtar<br>Torx Key<br>Torx-Schlüssel | Montaj Vidası<br>Mounting Screw<br>Befestigungsschraube |
| <b>new</b> AFM90-LN1306W-D040-A16-Z04-H            | ●                      | 40  | 4    | 16   | 40 | 12   | LNHU 1306..                               | 4115-M4x12                                  | 80-T15                                     | 2506-M8x30  |
| AFM90-LN1306W-D050-A22-Z05-H                       | ●                      | 50  | 5    | 22   | 40 | 12   |   |   |  | 2508-M10x30   |
| AFM90-LN1306W-D063-A22-Z06-H                       | ●                      | 63  | 6    | 22   | 40 | 12   |   |   |  | 2510-M12x35   |
| AFM90-LN1306W-D080-A27-Z07-H                       | ●                      | 80  | 7    | 27   | 50 | 12   |   |   |  | 2514-M16x35   |
| <b>new</b> AFM90-LN1306W-D100-A32-Z08-H            | ●                      | 100   | 8    | 32   | 50 | 12   |   |   |  |   |

WLTR Ucuna Uygun. / Compatible with WLTR Insert. / Kompatibel mit WLTR Wendeplatten.

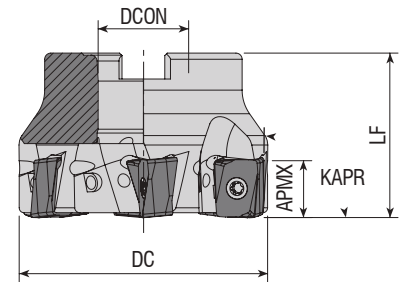

| Takım Kodu<br>Ordering Code<br>Bestell-Bezeichnung | Stok<br>Stock<br>Lager | Takım Ölçüleri (mm)<br>Dimension (mm)<br>Abmessung (mm) |      |      |    |      | Kesici Uç<br>Insert<br>Wendeschneidplatte | Yedek Parçaları / Spare Parts / Ersatzteile |  |   |
|--|------------------------|---|------|------|----|------|---|---|--|---|
|  |                        | DC  | ZEFP | DCON | LF | APMX |   | Sıkma Vidası<br>Screw<br>Schraube           | Tork Anahtar<br>Torx Key<br>Torx-Schlüssel | Montaj Vidası<br>Mounting Screw<br>Befestigungsschraube |
| AFM90-LN1307-D050-A22-Z04-H                        | ●                      | 50  | 4    | 22   | 40 | 13   | LNGX 1307..                               | 1315-M4x11                                  | 80-T15                                     | 2508-M10x30   |
| AFM90-LN1307-D063-A22-Z06-H                        | ●                      | 63  | 6    | 22   | 40 | 13   |   |   |  | 2510-M12x35   |
| AFM90-LN1307-D080-A27-Z07-H                        | ●                      | 80  | 7    | 27   | 50 | 13   |   |   |  | 2514-M16x35   |
| AFM90-LN1307-D100-A32-Z08-H                        | ●                      | 100   | 8    | 32   | 50 | 13   |   |   |  |   |

R: Sağ / Right / Rechts L: Sol / Left / Links

● Stokta / In Stock / Auf Lager ○ Stokta Yok / Non Stock Item / Kein Lagerartikel, Lieferzeit auf Anfrage

WLTR Ucuna Uygun. / Compatible with WLTR Insert. / Kompatibel mit WLTR Wendeplatten.

Sipariş Örneği/Ordering Example/Bestellbeispiel

1 ad./pcs./stück AFM90-LN1306W-D040-A16-Z04-H

Kesme Hesabı : S 367 / Cutting Calculation : P 367 / Schnittberechnung : P 367

Montaj Ölçüleri : S 364 / Mounting Reference : P 364 / Montagehinweis : P364

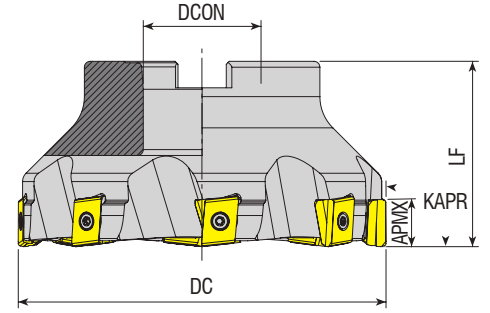

| Takım Kodu<br>Ordering Code<br>Bestell-Bezeichnung | Stok<br>Stock<br>Lager | Takım Ölçüleri (mm)<br>Dimension (mm)<br>Abmessung (mm) |      |      |    |      | Kesici Uç<br>Insert<br>Wendeschneidplatte | Yedek Parçaları / Spare Parts / Ersatzteile |  |   |
|--|------------------------|---|------|------|----|------|---|---|--|---|
|  |                        | DC  | ZEFP | DCON | LF | APMX |   | Sıkma Vidası<br>Screw<br>Schraube           | Tork Anahtar<br>Torx Key<br>Torx-Schlüssel | Montaj Vidası<br>Mounting Screw<br>Befestigungsschraube |
| AFM90-LN15Z-D050-A22-Z04                           | ●                      | 50  | 4    | 22   | 40 | 15   | LNKT 1506..                               | 4015-M4x11                                  | 80-T15                                     | 2508-M10x30   |
| AFM90-LN15Z-D063-A22-Z05                           | ●                      | 63  | 5    | 22   | 40 | 15   |   |   |  | 2510-M12x35   |
| AFM90-LN15Z-D080-A27-Z06                           | ●                      | 80  | 6    | 27   | 50 | 15   |   |   |  | 2514-M16x35   |
| AFM90-LN15Z-D100-A32-Z07                           | ●                      | 100   | 7    | 32   | 50 | 15   |   |   |  | -   |
| AFM90-LN15Z-D125-B40-Z08                           | ●                      | 125   | 8    | 40   | 63 | 15   |   |   |  | -   |

ZCC Ucuna Uygunur. / Compatible with ZCC Insert. / Kompatibel mit ZCC Wendeplatten.

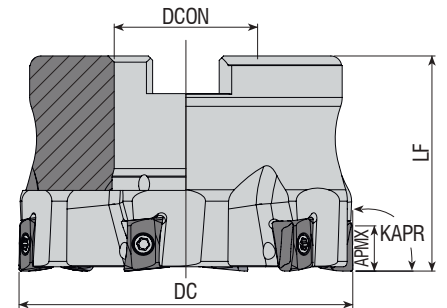

| Takım Kodu<br>Ordering Code<br>Bestell-Bezeichnung | Stok<br>Stock<br>Lager | Takım Ölçüleri (mm)<br>Dimension (mm)<br>Abmessung (mm) |      |      |    |      | Kesici Uç<br>Insert<br>Wendeschneidplatte | Yedek Parçaları / Spare Parts / Ersatzteile |  |   |
|--|------------------------|---|------|------|----|------|---|---|--|---|
|  |                        | DC  | ZEFP | DCON | LF | APMX |   | Sıkma Vidası<br>Screw<br>Schraube           | Tork Anahtar<br>Torx Key<br>Torx-Schlüssel | Montaj Vidası<br>Mounting Screw<br>Befestigungsschraube |
| AFM90-L008-D040-A16-Z06-H                          | ●                      | 40  | 6    | 16   | 40 | 2    | LOEX 0804..                               | 3008-M2.5x8                                 | 82-T08                                     | 2506-M8x30  |
| AFM90-L008-D050-A22-Z07-H                          | ●                      | 50  | 7    | 22   | 40 | 2    |   |   |  | 2508-M10x30   |
| AFM90-L008-D063-A27-Z06-H                          | ●                      | 63  | 6    | 27   | 40 | 2    |   |   |  | 2510-M12x35   |

R: Sağ / Right / Rechts L: Sol / Left / Links  
● Stokta / In Stock / Auf Lager ○ Stokta Yok / Non Stock Item / Kein Lagerartikel, Lieferzeit auf Anfrage  
SC Ucuna Uygunur. / Compatible with SC Insert. / Kompatibel mit SC Wendeplatten.

Sipariş Örneği/Ordering Example/Bestellbeispiel  
1 ad./pcs./stück AFM90-LN15Z-D050-A22-Z04  
Kesme Hesabı : S 367 / Cutting Calculation : P 367 / Schnittberechnung : P 367  
Montaj Ölçüleri : S 364 / Mounting Reference : P 364 / Montagehinweis : P 364

KAPR=90°

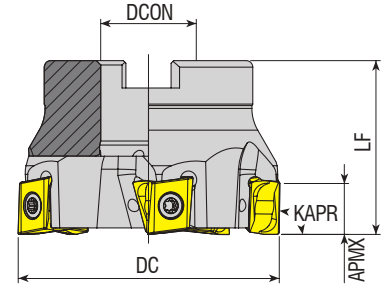

| Takım Kodu<br>Ordering Code<br>Bestell-Bezeichnung | Stok<br>Stock<br>Lager | Takım Ölçüleri (mm)<br>Dimension (mm)<br>Abmessung (mm) |     |      |    |      | Kesici Uç<br>Insert<br>Wendeschneidplatte | Yedek Parçaları / Spare Parts / Ersatzteile |  |   |             |
|--|------------------------|---|-----|------|----|------|---|---|--|---|-------------|
|  |                        | DC  | ZEP | DCON | LF | APMX |   | Sıkma Vidası<br>Screw<br>Schraube           | Tork Anahtar<br>Torx Key<br>Torx-Schlüssel | Montaj Vidası<br>Mounting Screw<br>Befestigungsschraube |             |
| <b>new</b> AFM90-L00904-D040-A16-Z06-H             | ●                      | 40  | 6   | 16   | 40 | 8    | LOGU 0904..                               |   |  |   |             |
| <b>new</b> AFM90-L00904-D050-A22-Z05-H             | ●                      | 50  | 5   | 22   | 40 | 8    |   |   |  |   | 2506-M8x30  |
| <b>new</b> AFM90-L00904-D050-A22-Z07-H             | ●                      | 50  | 7   | 22   | 40 | 8    |   |   |  |   | 2508-M10x30 |
| <b>new</b> AFM90-L00904-D063-A22-Z06-H             | ●                      | 63  | 6   | 22   | 40 | 8    | LOGU 1207..                               |   |  |   |             |
| AFM90-L01207-D040-A16-Z04-H                        | ●                      | 40  | 4   | 16   | 40 | 11   |   |   |  |   | 2506-M8x30  |
| AFM90-L01207-D050-A22-Z05-H                        | ●                      | 50  | 5   | 22   | 40 | 11   |   |   |  |   | 2508-M10x30 |
| AFM90-L01207-D063-A22-Z05-H                        | ●                      | 63  | 5   | 22   | 40 | 11   |   |   |  |   |             |
| <b>new</b> AFM90-L01207-D063-A22-Z06-H             | ●                      | 63  | 6   | 22   | 40 | 11   |   |   |  |   | 2510-M12x35 |
| <b>new</b> AFM90-L01207-D080-A27-Z07-H             | ●                      | 80  | 7   | 27   | 50 | 11   |   |   |  |   |             |
| <b>new</b> AFM90-L01207-D100-A32-Z07-H             | ●                      | 100   | 7   | 32   | 50 | 11   | 2514-M16x35                               |   |  |   |             |

MTSBH Ucuna Uygun. / Compatible with MTSBH Insert. / Kompatibel mit MTSBH Wendeplatten.

KAPR=90°

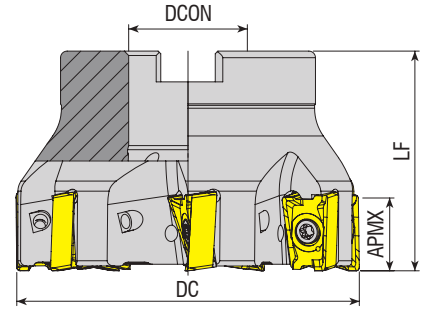

| Takım Kodu<br>Ordering Code<br>Bestell-Bezeichnung | Stok<br>Stock<br>Lager | Takım Ölçüleri (mm)<br>Dimension (mm)<br>Abmessung (mm) |     |      |    |      | Kesici Uç<br>Insert<br>Wendeschneidplatte | Yedek Parçaları / Spare Parts / Ersatzteile |  |   |             |
|--|------------------------|---|-----|------|----|------|---|---|--|---|-------------|
|  |                        | DC  | ZEP | DCON | LF | APMX |   | Sıkma Vidası<br>Screw<br>Schraube           | Tork Anahtar<br>Torx Key<br>Torx-Schlüssel | Montaj Vidası<br>Mounting Screw<br>Befestigungsschraube |             |
| AFM90-LN15T6-D050-A22-Z05-H                        | ●                      | 50  | 5   | 22   | 40 | 15.5 | LNGU 15T6..                               |   |  |   |             |
| AFM90-LN15T6-D063-A22-Z06-H                        | ●                      | 63  | 6   | 22   | 40 | 15.5 |   |   |  |   | 2508-M10x30 |
| AFM90-LN15T6-D080-A27-Z07-H                        | ●                      | 80  | 7   | 27   | 50 | 15.5 |   |   |  |   | 2510-M12x35 |

R: Sağ / Right / Rechts L: Sol / Left / Links

● Stokta / In Stock / Auf Lager ○ Stokta Yok / Non Stock Item / Kein Lagerartikel, Lieferzeit auf Anfrage  
KNMTL Ucuna Uygun. / Compatible with KNMTL Insert. / Kompatibel mit KNMTL Wendeplatten.

Sipariş Örneği/Ordering Example/Bestellbeispiel  
1 ad./pcs./stück AFM90-L009-D040-A16-Z06-H

Kesme Hesabı : S 377 / Cutting Calculation : P 377 / Schnittberechnung : P 377  
Montaj Ölçüleri : S 374 / Mounting Reference : P 374 / Montagehinweis : P374

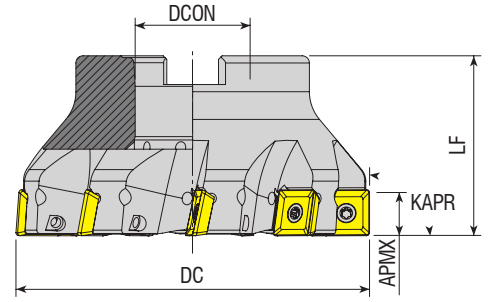

| Takım Kodu<br>Ordering Code<br>Bestell-Bezeichnung | Stok<br>Stock<br>Lager | Takım Ölçüleri (mm)<br>Dimension (mm)<br>Abmessung (mm) |      |      |    |                    | Kesici Uç<br>Insert<br>Wendeschneidplatte | Yedek Parçaları / Spare Parts / Ersatzteile |  |   |             |
|--|------------------------|---|------|------|----|--------------------|---|---|--|---|-------------|
|  |                        | DC  | ZEFP | DCON | LF | APMX               |   | Sıkma Vidası<br>Screw<br>Schraube           | Tork Anahtar<br>Torx Key<br>Torx-Schlüssel | Montaj Vidası<br>Mounting Screw<br>Befestigungsschraube |             |
| AFM90-R290.12-D050-A22-Z04-H                       | ●                      | 50  | 4    | 22   | 40 | 10.7               |   |   |  |   |             |
| AFM90-R290.12-D063-A22-Z05-H                       | ●                      | 63  | 5    | 22   | 40 | 10.7               |   |   |  |   |             |
| AFM90-R290.12-D080-A27-Z07-H                       | ●                      | 80  | 7    | 27   | 50 | 10.7               |   |   |  |   |             |
| AFM90-R290.12-D100-A32-Z09-H                       | ●                      | 100   | 9    | 32   | 50 | 10.7               |   |   |  |   |             |
| AFM90-R290.12-D125-B40-Z11                         | ●                      | 125   | 11   | 40   | 63 | 10.7               |   |   |  |   |             |
|  |                        |   |      |      |    | <b>R290-12T3..</b> | 4015-M3.5x11                              | 80-T15                                      | 2508-M10x30                                | 2510-M12x35   | 2514-M16x35 |

SNDVK Ucuna Uygunur. / Compatible with SNDVK Insert. / Kompatibel mit SNDVK Wendepfatten.

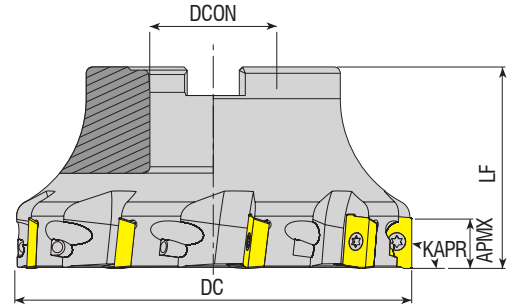

| Takım Kodu<br>Ordering Code<br>Bestell-Bezeichnung | Stok<br>Stock<br>Lager | Takım Ölçüleri (mm)<br>Dimension (mm)<br>Abmessung (mm) |      |      |    |                    | Kesici Uç<br>Insert<br>Wendeschneidplatte | Yedek Parçaları / Spare Parts / Ersatzteile |  |   |             |
|--|------------------------|---|------|------|----|--------------------|---|---|--|---|-------------|
|  |                        | DC  | ZEFP | DCON | LF | APMX               |   | Sıkma Vidası<br>Screw<br>Schraube           | Tork Anahtar<br>Torx Key<br>Torx-Schlüssel | Montaj Vidası<br>Mounting Screw<br>Befestigungsschraube |             |
| AFM90-R390.11-D040-A16-Z05-H                       | ●                      | 40  | 5    | 16   | 40 | 10                 |   |   |  |   |             |
| AFM90-R390.11-D050-A22-Z06-H                       | ●                      | 50  | 6    | 22   | 40 | 10                 |   |   |  |   |             |
| AFM90-R390.11-D063-A22-Z07-H                       | ●                      | 63  | 7    | 22   | 40 | 10                 |   |   |  |   |             |
| AFM90-R390.11-D080-A27-Z09-H                       | ●                      | 80  | 9    | 27   | 50 | 10                 |   |   |  |   |             |
| AFM90-R390.17-D040-A16-Z04-H                       | ●                      | 40  | 4    | 16   | 40 | 15.4               |   |   |  |   |             |
| AFM90-R390.17-D050-A22-Z05-H                       | ●                      | 50  | 5    | 22   | 40 | 15.4               |   |   |  |   |             |
| AFM90-R390.17-D063-A22-Z06-H                       | ●                      | 63  | 6    | 22   | 40 | 15.4               |   |   |  |   |             |
| AFM90-R390.17-D080-A27-Z07-H                       | ●                      | 80  | 7    | 27   | 50 | 15.4               |   |   |  |   |             |
| AFM90-R390.17-D100-A32-Z08-H                       | ●                      | 100   | 8    | 32   | 50 | 15.4               |   |   |  |   |             |
| AFM90-R390.17-D125-B40-Z09                         | ●                      | 125   | 9    | 40   | 63 | 15.4               |   |   |  |   |             |
| AFM90-R390.18-D050-A22-Z04-H                       | ●                      | 50  | 4    | 22   | 40 | 15.4               |   |   |  |   |             |
| AFM90-R390.18-D063-A22-Z05-H                       | ●                      | 63  | 5    | 22   | 40 | 15.4               |   |   |  |   |             |
| AFM90-R390.18-D080-A27-Z06-H                       | ●                      | 80  | 6    | 27   | 50 | 15.4               |   |   |  |   |             |
| AFM90-R390.18-D100-A32-Z07-H                       | ●                      | 100   | 7    | 32   | 50 | 15.4               |   |   |  |   |             |
| AFM90-R390.18-D125-B40-Z08                         | ●                      | 125   | 8    | 40   | 63 | 15.4               |   |   |  |   |             |
|  |                        |   |      |      |    | <b>R390-11T3..</b> | 3008-M2.5x6                               | 82-T08                                      | 2506-M8x30                                 | 2508-M10x30   | 2510-M12x35 |
|  |                        |   |      |      |    | <b>R390-1704..</b> | 4015-M3.5x11                              | 80-T15                                      | 2506-M8x30                                 | 2508-M10x30   | 2510-M12x35 |
|  |                        |   |      |      |    | <b>R390-1806..</b> | 4015-M4x11                                | 80-T15                                      | 2508-M10x30                                | 2510-M12x35   | 2514-M16x35 |

R: Sağ / Right / Rechts L: Sol / Left / Links

● Stokta / In Stock / Auf Lager ○ Stokta Yok / Non Stock Item / Kein Lagerartikel, Lieferzeit auf Anfrage  
SNDVK Ucuna Uygunur. / Compatible with SNDVK Insert. / Kompatibel mit SNDVK Wendepfatten.

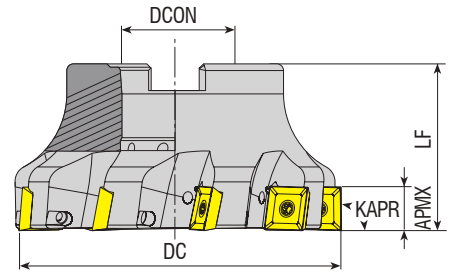

| Takım Kodu<br>Ordering Code<br>Bestell-Bezeichnung | Stok<br>Stock<br>Lager | Takım Ölçüleri (mm)<br>Dimension (mm)<br>Abmessung (mm) |      |      |    |      | Kesici Uç<br>Insert<br>Wendeschneidplatte | Yedek Parçaları / Spare Parts / Ersatzteile |  |   |
|--|------------------------|---|------|------|----|------|---|---|--|---|
|  |                        | DC  | ZEFP | DCON | LF | APMX |   | Sıkma Vidası<br>Screw<br>Schraube           | Tork Anahtar<br>Torx Key<br>Torx-Schlüssel | Montaj Vidası<br>Mounting Screw<br>Befestigungsschraube |
| AFM90-490R08-D063-A22-Z06-H                        | ●                      | 63  | 6    | 22   | 40 | 5.5  | 490R-08T3..                               | 3008-M2.5x6                                 | 82-T08                                     | 2508-M10x30   |
| AFM90-490R14-D050-A22-Z04-H                        | ●                      | 50  | 4    | 22   | 40 | 10   |   |   |  |   |
| AFM90-490R14-D063-A22-Z05-H                        | ●                      | 63  | 5    | 22   | 40 | 10   | 490R-1404..                               | 4015-M3.5x11                                | 80-T15                                     | 2510-M12x35<br>2514-M16x35                              |
| AFM90-490R14-D080-A27-Z07-H                        | ●                      | 80  | 7    | 27   | 50 | 10   |   |   |  |   |
| AFM90-490R14-D100-A32-Z07-H                        | ●                      | 100   | 7    | 32   | 50 | 10   |   |   |  |   |
| AFM90-490R14-D125-B40-Z08                          | ●                      | 125   | 8    | 40   | 63 | 10   |   |   |  |   |
| new AFM90-490R14-D125-B40-Z12                      | ●                      | 125   | 12   | 40   | 63 | 10   |   |   |  |   |
| AFM90-490R14-D160-C40-Z12                          | ●                      | 160   | 12   | 40   | 63 | 10   |   |   |  |   |
| AFM90-490R14-D200-C60-Z16                          | ●                      | 200   | 16   | 60   | 63 | 10   |   |   |  | -   |

SNDVK Ucuna Uygundur. / Compatible with SNDVK Insert. / Kompatibel mit SNDVK Wendepplatten.

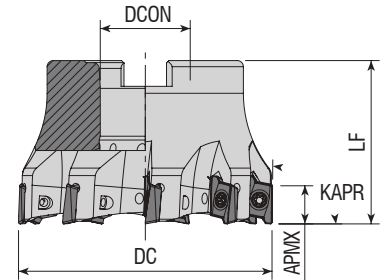

| Takım Kodu<br>Ordering Code<br>Bestell-Bezeichnung | Stok<br>Stock<br>Lager | Takım Ölçüleri (mm)<br>Dimension (mm)<br>Abmessung (mm) |      |      |    |      | Kesici Uç<br>Insert<br>Wendeschneidplatte | Yedek Parçaları / Spare Parts / Ersatzteile |  |   |
|--|------------------------|---|------|------|----|------|---|---|--|---|
|  |                        | DC  | ZEFP | DCON | LF | APMX |   | Sıkma Vidası<br>Screw<br>Schraube           | Tork Anahtar<br>Torx Key<br>Torx-Schlüssel | Montaj Vidası<br>Mounting Screw<br>Befestigungsschraube |
| AFM90-RT10-D040-A16-Z06-H                          | ●                      | 40  | 6    | 16   | 40 | 10   | RT 1003                                   | 3008-M2.5x6                                 | 82-T08                                     | 2506-M8x30<br>2407-M10x30                               |
| AFM90-RT10-D050-A22-Z07-H                          | ●                      | 50  | 7    | 22   | 40 | 10   |   |   |  |   |
| AFM90-RT10-D063-A22-Z09-H                          | ●                      | 63  | 9    | 22   | 40 | 10   |   |   |  |   |
| new AFM90-RT16-D040-A16-Z04-H                      | ●                      | 40  | 4    | 16   | 40 | 16   | RT 1606                                   | 4015-M4x11                                  | 80-T15                                     | 2506-M8x30<br>2508-M10x30<br>2510-M12x35                |
| new AFM90-RT16-D063-A22-Z06-H                      | ●                      | 63  | 6    | 22   | 40 | 16   |   |   |  |   |
| new AFM90-RT16-D080-A27-Z07-H                      | ●                      | 80  | 7    | 27   | 50 | 16   |   |   |  |   |
| new AFM90-RT16-D125-B40-Z09                        | ●                      | 125   | 9    | 40   | 63 | 16   |   |   |  |   |

R: Sağ / Right / Rechts L: Sol / Left / Links

● Stokta / In Stock / Auf Lager ○ Stokta Yok / Non Stock Item / Kein Lagerartikel, Lieferzeit auf Anfrage  
SFTY Ucuna Uygundur. / Compatible with SFTY Insert. / Kompatibel mit SFTY Wendepplatten.

Sipariş Örneği/Ordering Example/Bestellbeispiel

1 ad./pcs./stück AFM90-490R08-D063-A22-Z06-H

Kesme Hesabı : S 377 / Cutting Calculation : P 377 / Schnittberechnung : P 377  
Montaj Ölçüleri : S 374 / Mounting Reference : P 374 / Montagehinweis : P 374

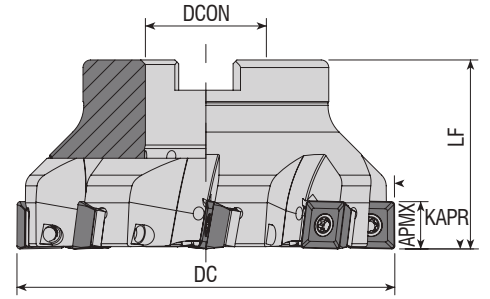

| Takım Kodu<br>Ordering Code<br>Bestell-Bezeichnung | Stok<br>Stock<br>Lager | Takım Ölçüleri (mm)<br>Dimension (mm)<br>Abmessung (mm) |      |      |    |      | Kesici Uç<br>Insert<br>Wendeschneidplatte | Yedek Parçaları / Spare Parts / Ersatzteile |   |                                   |  |   |
|--|------------------------|---|------|------|----|------|---|---|---|-----------------------------------|--|---|
|  |                        | DC  | ZEFP | DCON | LF | APMX |   | Altlık<br>Screw<br>Unterlage                | Baskı Parçası<br>Wedge Clamp<br>Spannpratze | Sıkma Vidası<br>Screw<br>Schraube | Tork Anahtar<br>Torx Key<br>Torx-Schlüssel | Montaj Vidası<br>Mounting Screw<br>Befestigungsschraube |
| AFM90S-SD1204-D050-A22-Z04-H                       | ●                      | 50  | 4    | 22   | 40 | 11   | SDMT 1204..                               | AASD-3-0001                                 | AAV-08-M3.5x8                               | 4015-M3.5x12                      | 80-T15                                     | 2408-M10x30   |
| AFM90S-SD1204-D063-A22-Z05-H                       | ●                      | 63  | 5    | 22   | 40 | 11   |   |   |   |                                   |  | 2508-M10x30   |
| AFM90S-SD1204-D080-A27-Z06-H                       | ●                      | 80  | 6    | 27   | 50 | 11   |   |   |   |                                   |  | 2510-M12x35   |
| AFM90S-SD1204-D100-A32-Z08-H                       | ●                      | 100   | 8    | 32   | 50 | 11   |   |   |   |                                   |  | 2514-M16x35   |
| AFM90S-SD1204-D125-B40-Z10                         | ●                      | 125   | 10   | 40   | 63 | 11   |   |   |   |                                   |  | -   |
| AFM90S-SD1204-D160-C40-Z12                         | ●                      | 160   | 12   | 40   | 63 | 11   |   |   |   |                                   |  | -   |

DJT Ucuna Uygunudur. / Compatible with DJT Insert. / Kompatibel mit DJT Wendeschneidplatten.

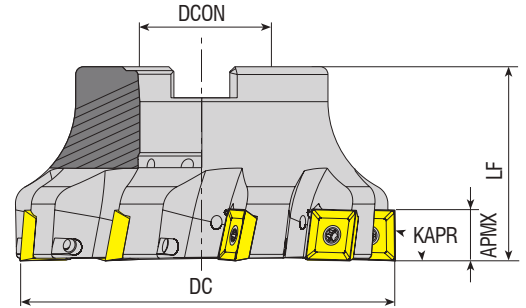

| Takım Kodu<br>Ordering Code<br>Bestell-Bezeichnung | Stok<br>Stock<br>Lager | Takım Ölçüleri (mm)<br>Dimension (mm)<br>Abmessung (mm) |      |      |    |      | Kesici Uç<br>Insert<br>Wendeschneidplatte | Yedek Parçaları / Spare Parts / Ersatzteile |  |   |
|--|------------------------|---|------|------|----|------|---|---|--|---|
|  |                        | DC  | ZEFP | DCON | LF | APMX |   | Sıkma Vidası<br>Screw<br>Schraube           | Tork Anahtar<br>Torx Key<br>Torx-Schlüssel | Montaj Vidası<br>Mounting Screw<br>Befestigungsschraube |
| AFM90-SD09M4-D040-A16-Z04-H                        | ●                      | 40  | 4    | 16   | 40 | 9    | SD.. 09M4..                               | 4015-M3.5x11                                | 80-T15                                     | 2406-M8x30  |
| AFM90-SD09M4-D050-A22-Z05-H                        | ●                      | 50  | 5    | 22   | 40 | 9    |   |   |  | 2508-M10x30   |
| AFM90-SD09M4-D063-A22-Z06-H                        | ●                      | 63  | 6    | 22   | 40 | 9    |   |   |  | 2510-M12x35   |
| AFM90-SD09M4-D080-A27-Z07-H                        | ●                      | 80  | 7    | 27   | 50 | 9    |   |   |  | 2514-M16x35   |
| AFM90-SD1305-D050-A22-Z04-H                        | ●                      | 50  | 4    | 22   | 40 | 13   | SD.. 1305..                               | 1020-M5x11                                  | 80-T20                                     | 2408-M10x30   |
| AFM90-SD1305-D063-A22-Z05-H                        | ●                      | 63  | 5    | 22   | 50 | 13   |   |   |  | 2508-M10x30   |
| AFM90-SD1305-D080-A27-Z06-H                        | ●                      | 80  | 6    | 27   | 50 | 13   |   |   |  | 2510-M12x35   |
| AFM90-SD1305-D100-A32-Z07-H                        | ●                      | 100   | 7    | 32   | 50 | 13   |   |   |  | 2514-M16x35   |
| AFM90-SD1305-D125-B40-Z08                          | ●                      | 125   | 8    | 40   | 63 | 13   |   |   |  | -   |
| AFM90-SD1305-D160-C40-Z10                          | ●                      | 160   | 10   | 40   | 63 | 13   |   |   |  | -   |

R: Sağ / Right / Rechts L: Sol / Left / Links

● Stokta / In Stock / Auf Lager ○ Stokta Yok / Non Stock Item / Kein Lagerartikel, Lieferzeit auf Anfrage

KRLY Ucuna Uygunudur. / Compatible with KRLY Insert. / Kompatibel mit KRLY Wendeschneidplatten.

Sipariş Örneği/Ordering Example/Bestellbeispiel

1 ad./pcs./stück AFM90S-SD1204-D050-A22-Z04-H

Kesme Hesabı : S 377 / Cutting Calculation : P 377 / Schnittberechnung : P 377

Montaj Ölçüleri : S 374 / Mounting Reference : P 374 / Montagehinweis : P 374

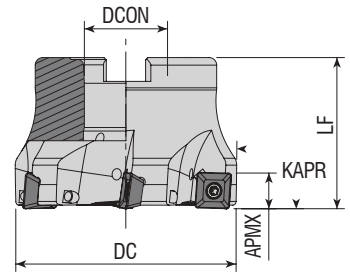

| Takım Kodu<br>Ordering Code<br>Bestell-Bezeichnung | Stok<br>Stock<br>Lager | Takım Ölçüleri (mm)<br>Dimension (mm)<br>Abmessung (mm) |      |      |    |      | Kesici Uç<br>Insert<br>Wendeschneidplatte | Yedek Parçaları / Spare Parts / Ersatzteile |  |   |  |
|--|------------------------|---|------|------|----|------|---|---|--|---|--|
|  |                        | DC  | ZEFP | DCON | LF | APMX |   | Sıkma Vidası<br>Screw<br>Schraube           | Tork Anahtar<br>Torx Key<br>Torx-Schlüssel | Montaj Vidası<br>Mounting Screw<br>Befestigungsschraube |  |
| AFM90-SE09-D040-A16-Z04-H                          | ●                      | 40  | 4    | 16   | 40 | 6.7  | SEET 09T3..                               | 3008-M3x8                                   | 82-T08                                     | 2506-M8x30  |  |
| AFM90-SE09-D050-A22-Z05-H                          | ●                      | 50  | 5    | 22   | 40 | 6.7  |   |   |  | 2508-M10x30   |  |
| AFM90-SE09-D063-A22-Z06-H                          | ●                      | 63  | 6    | 22   | 40 | 6.7  |   |   |  | -   |  |

ZCC Ucuna Uygundur. / Compatible with ZCC Insert. / Kompatibel mit ZCC Wendeplatten.

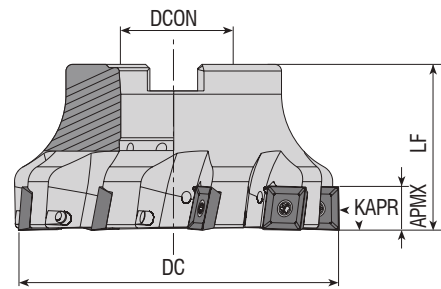

| Takım Kodu<br>Ordering Code<br>Bestell-Bezeichnung | Stok<br>Stock<br>Lager | Takım Ölçüleri (mm)<br>Dimension (mm)<br>Abmessung (mm) |      |      |    |      | Kesici Uç<br>Insert<br>Wendeschneidplatte | Yedek Parçaları / Spare Parts / Ersatzteile |  |   |  |
|--|------------------------|---|------|------|----|------|---|---|--|---|--|
|  |                        | DC  | ZEFP | DCON | LF | APMX |   | Sıkma Vidası<br>Screw<br>Schraube           | Tork Anahtar<br>Torx Key<br>Torx-Schlüssel | Montaj Vidası<br>Mounting Screw<br>Befestigungsschraube |  |
| AFM90-SE12-D050-A22-Z04-H                          | ●                      | 50  | 4    | 22   | 40 | 12   | SEET 1203..                               | 4015-M3.5x11                                | 80-T15                                     | 2508-M10x30   |  |
| AFM90-SE12-D063-A22-Z05-H                          | ●                      | 63  | 5    | 22   | 40 | 12   |   |   |  | 2510-M12x35   |  |
| AFM90-SE12-D080-A27-Z07-H                          | ●                      | 80  | 7    | 27   | 50 | 12   |   |   |  | 2514-M16x35   |  |
| AFM90-SE12-D100-A32-Z09-H                          | ●                      | 100   | 9    | 32   | 50 | 12   |   |   |  | -   |  |
| AFM90-SE12-D125-B40-Z11                            | ●                      | 125   | 11   | 40   | 63 | 12   |   |   |  | -   |  |

R: Sağ / Right / Rechts L: Sol / Left / Links

● Stokta / In Stock / Auf Lager ○ Stokta Yok / Non Stock Item / Kein Lagerartikel, Lieferzeit auf Anfrage

ZCC Ucuna Uygundur. / Compatible with ZCC Insert. / Kompatibel mit ZCC Wendeplatten.

Sipariş Örneği/Ordering Example/Bestellbeispiel  
1 ad./pcs./stück AFM90-SE09-D040-A16-Z04-H

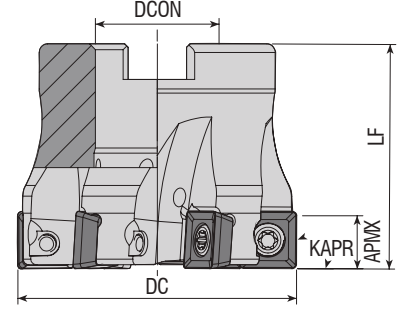

| Takım Kodu<br>Ordering Code<br>Bestell-Bezeichnung | Stok<br>Stock<br>Lager | Takım Ölçüleri (mm)<br>Dimension (mm)<br>Abmessung (mm) |      |      |    |      | Kesici Uç<br>Insert<br>Wendeschneidplatte  | Yedek Parçaları / Spare Parts / Ersatzteile |  |   |
|--|------------------------|---|------|------|----|------|--|---|--|---|
|  |                        | DC  | ZEFP | DCON | LF | APMX |  | Sıkma Vidası<br>Screw<br>Schraube           | Tork Anahtar<br>Torx Key<br>Torx-Schlüssel | Montaj Vidası<br>Mounting Screw<br>Befestigungsschraube |
| AFM90-SP1004-D040-A16-Z04-H                        | ●                      | 40  | 4    | 16   | 40 | 9.4  | <br><b>SPMT 1004..</b><br><b>XPMT 1004..</b><br><b>QPMR 1004..</b><br><b>QPMT 1004..</b> | <br>4015-M4x10                              | <br>80-T15                                 | 2506-M8x30  |
| AFM90-SP1004-D050-A22-Z04-H                        | ●                      | 50  | 4    | 22   | 40 | 9.4  |  |   |  | 2508-M10x30   |
| AFM90-SP1004-D050-A22-Z06-H                        | ●                      | 50  | 6    | 22   | 40 | 9.4  |  |   |  | 2510-M12x35   |
| AFM90-SP1004-D063-A22-Z05-H                        | ●                      | 63  | 5    | 22   | 40 | 9.4  |  |   |  | 2514-M16x35   |
| AFM90-SP1004-D080-A27-Z07-H                        | ●                      | 80  | 7    | 27   | 50 | 9.4  |  |   |  |   |
| AFM90-SP1004-D100-A32-Z08-H                        | ●                      | 100   | 8    | 32   | 50 | 9.4  |  |   |  |   |

ISCR Ucuna Uygunur. / Compatible with ISCR Insert. / Kompatibel mit ISCR Wendepplatten.

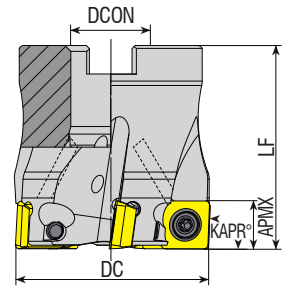

| Takım Kodu<br>Ordering Code<br>Bestell-Bezeichnung | Stok<br>Stock<br>Lager | Takım Ölçüleri (mm)<br>Dimension (mm)<br>Abmessung (mm) |      |      |    |      | Kesici Uç<br>Insert<br>Wendeschneidplatte | Yedek Parçaları / Spare Parts / Ersatzteile |  |   |
|--|------------------------|---|------|------|----|------|---|---|--|---|
|  |                        | DC  | ZEFP | DCON | LF | APMX |   | Sıkma Vidası<br>Screw<br>Schraube           | Tork Anahtar<br>Torx Key<br>Torx-Schlüssel | Montaj Vidası<br>Mounting Screw<br>Befestigungsschraube |
| AFM90-SP09T3-D040-A16-Z05-H                        | ●                      | 40  | 5    | 16   | 40 | 8.6  | <br><b>SPMT 09T3..</b>                    | <br>3010-M3.5x9                             | <br>82-T10                                 | 2506-M8x30  |
| AFM90-SP09T3-D050-A22-Z06-H                        | ●                      | 50  | 6    | 22   | 40 | 8.6  |   |   |  | 2508-M10x30   |
| AFM90-SP09T3-D063-A22-Z07-H                        | ●                      | 63  | 7    | 22   | 40 | 8.6  |   |   |  | 2510-M12x35   |
| AFM90-SP09T3-D080-A27-Z08-H                        | ●                      | 80  | 8    | 27   | 50 | 8.6  |   |   |  |   |

R: Sağ / Right / Rechts L: Sol / Left / Links

● Stokta / In Stock / Auf Lager ○ Stokta Yok / Non Stock Item / Kein Lagerartikel, Lieferzeit auf Anfrage

SNDVK Ucuna Uygunur. / Compatible with SNDVK Insert. / Kompatibel mit SNDVK Wendepplatten.

Sipariş Örneği/Ordering Example/Bestellbeispiel

1 ad./pcs./stück AFM90-SP1004-D040-A16-Z04-H

Kesme Hesabı : S 377 / Cutting Calculation : P 377 / Schnittberechnung : P 377

Montaj Ölçüleri : S 374 / Mounting Reference : P 374 / Montagehinweis : P374





KAPR=90°

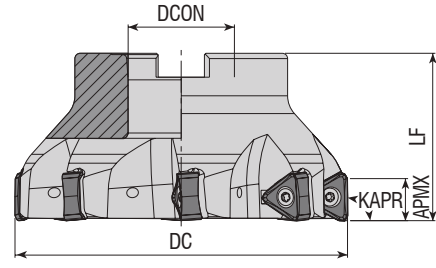

**Takım Kodu**  
**Ordering Code**  
**Bestell-Bezeichnung**

Stok  
Stock  
Lager

Takım Ölçüleri (mm)  
Dimension (mm)  
Abmessung (mm)

Kesici Uç  
Insert  
Wendeschneidplatte

Yedek Parçaları / Spare Parts / Ersatzteile

Sıkma Vidası  
Screw  
Schraube

Tork Anahtar  
Torx Key  
Torx-Schlüssel

Montaj Vidası  
Mounting Screw  
Befestigungsschraube

| Takım Kodu<br>Ordering Code<br>Bestell-Bezeichnung | Stok<br>Stock<br>Lager | DC  | ZEFP | DCON | LF | APMX | Kesici Uç<br>Insert<br>Wendeschneidplatte | Sıkma Vidası<br>Screw<br>Schraube | Tork Anahtar<br>Torx Key<br>Torx-Schlüssel | Montaj Vidası<br>Mounting Screw<br>Befestigungsschraube |
|--|------------------------|-----|------|------|----|------|---|-----------------------------------|--|---|
| AFM90-TNG10-D040-A16-Z04-H                         | ●                      | 40  | 4    | 16   | 40 | 5    | TNGX 1004..                               | 3008-M2.5x6                       | 82-T08                                     | 2506-M8x30  |
| AFM90-TNG10-D040-A16-Z06-H                         | ○                      | 40  | 6    | 16   | 40 | 5    |   |                                   |  |   |
| AFM90-TNG10-D050-A22-Z05-H                         | ○                      | 50  | 5    | 22   | 40 | 5    |   |                                   |  |   |
| AFM90-TNG10-D050-A22-Z07-H                         | ○                      | 50  | 7    | 22   | 40 | 5    |   |                                   |  |   |
| AFM90-TNG10-D063-A22-Z06-H                         | ○                      | 63  | 6    | 22   | 40 | 5    |   |                                   |  |   |
| AFM90-TNG10-D063-A22-Z09-H                         | ○                      | 63  | 9    | 22   | 40 | 5    |   |                                   |  |   |
| AFM90-TNG10-D080-A27-Z10-H                         | ○                      | 80  | 10   | 27   | 50 | 5    |   |                                   |  |   |
| AFM90-TNG16-D040-A16-Z03-H                         | ○                      | 40  | 3    | 16   | 40 | 10   | TNGX 1606..                               | 3015-M4x11                        | 80-T15                                     | 2510-M12X35   |
| AFM90-TNG16-D040-A16-Z04-H                         | ○                      | 40  | 4    | 16   | 40 | 10   |   |                                   |  |   |
| AFM90-TNG16-D050-A22-Z04-H                         | ○                      | 50  | 4    | 22   | 40 | 10   |   |                                   |  |   |
| AFM90-TNG16-D050-A22-Z05-H                         | ○                      | 50  | 5    | 22   | 40 | 10   |   |                                   |  |   |
| AFM90-TNG16-D063-A22-Z04-H                         | ○                      | 63  | 4    | 22   | 40 | 10   |   |                                   |  |   |
| AFM90-TNG16-D063-A22-Z06-H                         | ○                      | 63  | 6    | 22   | 40 | 10   |   |                                   |  |   |
| AFM90-TNG16-D080-A27-Z05-H                         | ○                      | 80  | 5    | 27   | 50 | 10   |   |                                   |  |   |
| AFM90-TNG16-D080-A27-Z07-H                         | ●                      | 80  | 7    | 27   | 50 | 10   |   |                                   |  |   |
| AFM90-TNG16-D100-A32-Z06-H                         | ○                      | 100 | 6    | 32   | 50 | 10   |   |                                   |  |   |
| AFM90-TNG16-D100-A32-Z08-H                         | ○                      | 100 | 8    | 32   | 50 | 10   |   |                                   |  |   |
| AFM90-TNG16-D115-A32-Z06-H                         | ○                      | 115 | 6    | 32   | 50 | 10   |   |                                   |  |   |
| AFM90-TNG16-D125-A40-Z07-H                         | ○                      | 125 | 7    | 40   | 63 | 10   |   |                                   |  |   |
| AFM90-TNG16-D125-A40-Z09-H                         | ○                      | 125 | 9    | 40   | 63 | 10   |   |                                   |  |   |
| AFM90-TNG16-D140-B40-Z08-H                         | ○                      | 140 | 8    | 40   | 63 | 10   |   |                                   |  |   |
| AFM90-TNG16-D160-C40-Z10-H                         | ○                      | 160 | 10   | 40   | 63 | 10   |   |                                   |  |   |
| AFM90-TNG16-D175-C40-Z10-H                         | ○                      | 175 | 10   | 40   | 63 | 10   |   |                                   |  |   |

R: Sağ / Right / Rechts L: Sol / Left / Links

● Stokta / In Stock / Auf Lager ○ Stokta Yok / Non Stock Item / Kein Lagerartikel, Lieferzeit auf Anfrage

PRMT Ucuna Uygundur. / Compatible with PRMT Insert. / Kompatibel mit PRMT Wendeplatten.

Sipariş Örneği/Ordering Example/Bestellbeispiel  
1 ad./pcs./stück AFM90-TNG10-D040-A16-Z04-H

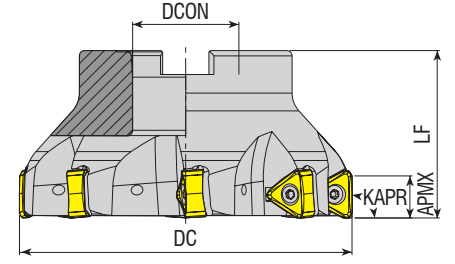

| Takım Kodu<br>Ordering Code<br>Bestell-Bezeichnung | Stok<br>Stock<br>Lager | Takım Ölçüleri (mm)<br>Dimension (mm)<br>Abmessung (mm) |      |      |    |      | Kesici Uç<br>Insert<br>Wendeschneidplatte | Yedek Parçaları / Spare Parts / Ersatzteile |  |   |
|--|------------------------|---|------|------|----|------|---|---|--|---|
|  |                        | DC  | ZEFP | DCON | LF | APMX |   | Sıkma Vidası<br>Screw<br>Schraube           | Tork Anahtar<br>Torx Key<br>Torx-Schlüssel | Montaj Vidası<br>Mounting Screw<br>Befestigungsschraube |
| AFM90-TN2207-D063-A22-Z04-H                        | ●                      | 63  | 4    | 22   | 40 | 15   | TN.X 2207..                               | 1120-M4.5x12                                | 80-T20                                     | 2508-M10x30   |
| AFM90-TN2207-D080-A27-Z05-H                        | ●                      | 80  | 5    | 27   | 50 | 15   |   |   |  | 2510-M12x35   |
| AFM90-TN2207-D100-B32-Z06                          | ●                      | 100   | 6    | 32   | 50 | 15   |   |   |  | 2514-M16x35   |
| AFM90-TN2207-D125-B40-Z08                          | ●                      | 125   | 8    | 40   | 63 | 15   |   |   |  | -   |

TGTC Ucuna Uygunur. / Compatible with TGTC Insert. / Kompatibel mit TGTC Wendeplatten.

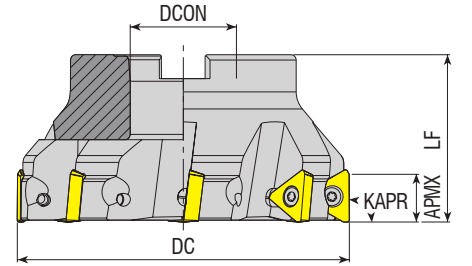

| Takım Kodu<br>Ordering Code<br>Bestell-Bezeichnung | Stok<br>Stock<br>Lager | Takım Ölçüleri (mm)<br>Dimension (mm)<br>Abmessung (mm) |      |      |    |      | Kesici Uç<br>Insert<br>Wendeschneidplatte | Yedek Parçaları / Spare Parts / Ersatzteile |  |   |
|--|------------------------|---|------|------|----|------|---|---|--|---|
|  |                        | DC  | ZEFP | DCON | LF | APMX |   | Sıkma Vidası<br>Screw<br>Schraube           | Tork Anahtar<br>Torx Key<br>Torx-Schlüssel | Montaj Vidası<br>Mounting Screw<br>Befestigungsschraube |
| AFM90-TP2205-D063-A22-Z04                          | ●                      | 63  | 4    | 22   | 40 | 18   | TPKT 2205..                               | 1120-M4.5x12                                | 80-T20                                     | 2508-M10x30   |
| AFM90-TP2205-D080-A27-Z06                          | ●                      | 80  | 6    | 27   | 50 | 18   |   |   |  | 2510-M12x35   |
| AFM90-TP2205-D100-A32-Z07                          | ●                      | 100   | 7    | 32   | 50 | 18   |   |   |  | 2514-M16x35   |
| AFM90-TP2205-D125-B40-Z08                          | ●                      | 125   | 8    | 40   | 63 | 18   |   |   |  | -   |
| AFM90-TP2205-D160-C40-Z09                          | ●                      | 160   | 9    | 40   | 63 | 18   |   |   |  | -   |
| AFM90-TP2205-D200-C60-Z12                          | ●                      | 200   | 12   | 60   | 63 | 18   |   |   |  | -   |

R: Sağ / Right / Rechts L: Sol / Left / Links

● Stokta / In Stock / Auf Lager ○ Stokta Yok / Non Stock Item / Kein Lagerartikel, Lieferzeit auf Anfrage  
TGTC Ucuna Uygunur. / Compatible with TGTC Insert. / Kompatibel mit TGTC Wendeplatten.

Sipariş Örneği/Ordering Example/Bestellbeispiel

1 ad./pcs./stück AFM90-TN2207-D063-A22-Z04-H

Kesme Hesabı : S 377 / Cutting Calculation : P 377 / Schnittberechnung : P 377

Montaj Ölçüleri : S 374 / Mounting Reference : P 374 / Montagehinweis : P374

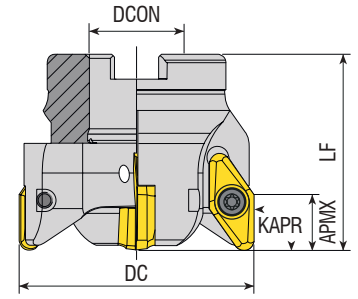
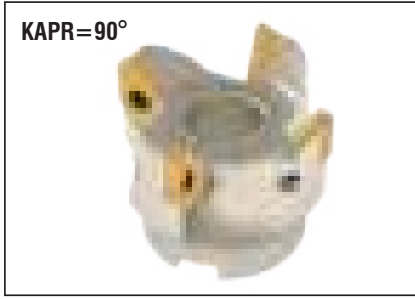

| Takım Kodu<br>Ordering Code<br>Bestell-Bezeichnung | Stok<br>Stock<br>Lager | Takım Ölçüleri (mm)<br>Dimension (mm)<br>Abmessung (mm) |      |      |    |      | Kesici Uç<br>Insert<br>Wendeschneidplatte | Yedek Parçaları / Spare Parts / Ersatzteile |  |   |
|--|------------------------|---|------|------|----|------|---|---|--|---|
|  |                        | DC  | ZEFP | DCON | LF | APMX |   | Sıkma Vidası<br>Screw<br>Schraube           | Tork Anahtar<br>Torx Key<br>Torx-Schlüssel | Montaj Vidası<br>Mounting Screw<br>Befestigungsschraube |
| AFM90-VC2205-D050-A22-Z03-H                        | ●                      | 50  | 3    | 22   | 55 | 15   | VCKT 2205..                               | 4015-M4.5x11                                | 80-T15                                     | 2508-M10x30   |
| AFM90-VC2205-D063-A22-Z04-H                        | ●                      | 63  | 4    | 22   | 55 | 15   |   |   |  |   |
| AFM90-VC2205-D066-A27-Z04-H                        | ●                      | 66  | 4    | 27   | 55 | 15   |   |   |  |   |
| AFM90-VC2205-D080-A27-Z05-H                        | ●                      | 80  | 5    | 27   | 60 | 15   |   |   |  | 2510-M12x35   |

ISO Ucuna Uygundur. / Compatible with ISO Insert. / Kompatibel mit ISO Wendeplatten.

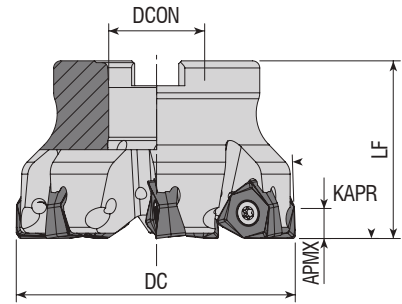

| Takım Kodu<br>Ordering Code<br>Bestell-Bezeichnung | Stok<br>Stock<br>Lager | Takım Ölçüleri (mm)<br>Dimension (mm)<br>Abmessung (mm) |      |      |    |      | Kesici Uç<br>Insert<br>Wendeschneidplatte | Yedek Parçaları / Spare Parts / Ersatzteile |  |   |
|--|------------------------|---|------|------|----|------|---|---|--|---|
|  |                        | DC  | ZEFP | DCON | LF | APMX |   | Sıkma Vidası<br>Screw<br>Schraube           | Tork Anahtar<br>Torx Key<br>Torx-Schlüssel | Montaj Vidası<br>Mounting Screw<br>Befestigungsschraube |
| AFM90-WNG04-D040-A16-Z06-H                         | ●                      | 40  | 6    | 16   | 40 | 4    | WNGU 0403..                               | 3008-M3x6                                   | 82-T08                                     | 2506-M8x30  |
| AFM90-WNG04-D050-A22-Z05-H                         | ●                      | 50  | 5    | 22   | 40 | 4    |   |   |  |   |
| AFM90-WNG04-D050-A22-Z07-H                         | ●                      | 50  | 7    | 22   | 40 | 4    |   |   |  |   |
| AFM90-WNG04-D063-A22-Z06-H                         | ●                      | 63  | 6    | 22   | 40 | 4    |   |   |  | 2508-M10x30   |
| AFM90-WNG08-D050-A22-Z05-H                         | ●                      | 50  | 5    | 22   | 40 | 7.5  | WNGU 0806..                               | 4015-M4x11                                  | 80-T15                                     | 2510-M12x35   |
| AFM90-WNG08-D063-A22-Z06-H                         | ●                      | 63  | 6    | 22   | 40 | 7.5  |   |   |  |   |
| AFM90-WNG08-D080-A27-Z07-H                         | ●                      | 80  | 7    | 27   | 50 | 7.5  |   |   |  |   |
| <b>new</b> AFM90-WNG08-D100-A32-Z07-H              | ●                      | 100   | 10   | 32   | 50 | 7.5  |   |   |  | 2514-M16x35   |

R: Sağ / Right / Rechts L: Sol / Left / Links

● Stokta / In Stock / Auf Lager ○ Stokta Yok / Non Stock Item / Kein Lagerartikel, Lieferzeit auf Anfrage

XTC-GSC Ucuna Uygundur. / Compatible with XTC-GSC Insert. / Kompatibel mit XTC-GSC Wendeplatten.

Sipariş Örneği/Ordering Example/Bestellbeispiel

1 ad./pcs./stück AFM90-VC2205-D050-A22-Z03-H

Kesme Hesabı : S 377 / Cutting Calculation : P 377 / Schnittberechnung : P 377

Montaj Ölçüleri : S 374 / Mounting Reference : P 374 / Montagehinweis : P374

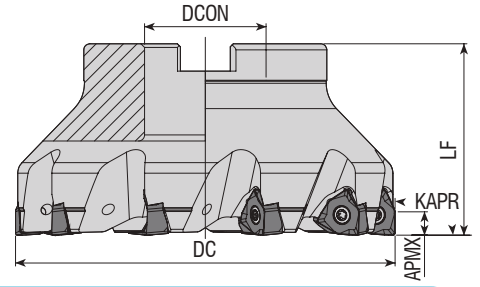

| Takım Kodu<br>Ordering Code<br>Bestell-Bezeichnung | Stok<br>Stock<br>Lager | Takım Ölçüleri (mm)<br>Dimension (mm)<br>Abmessung (mm) |      |      |    |      | Kesici Uç<br>Insert<br>Wendeschneidplatte | Yedek Parçaları / Spare Parts / Ersatzteile |  |   |
|--|------------------------|---|------|------|----|------|---|---|--|---|
|  |                        | DC  | ZEFP | DCON | LF | APMX |   | Sıkma Vidası<br>Screw<br>Schraube           | Tork Anahtar<br>Torx Key<br>Torx-Schlüssel | Montaj Vidası<br>Mounting Screw<br>Befestigungsschraube |
| AFM90-WN0604Z-D040-A16-Z04-H                       | ●                      | 40  | 4    | 16   | 40 | 5.7  | WNHU 0604..                               | 3008-M3x8                                   | 82-T08                                     | 2506-M8x30  |
| AFM90-WN0604Z-D050-A22-Z05-H                       | ●                      | 50  | 5    | 22   | 40 | 5.7  |   |   |  | 2508-M10x30   |
| AFM90-WN0604Z-D063-A22-Z06-H                       | ●                      | 63  | 6    | 22   | 40 | 5.7  |   |   |  | 2510-M12x35   |
| AFM90-WN0604Z-D080-A27-Z07-H                       | ●                      | 80  | 7    | 27   | 50 | 5.7  |   |   |  | 2514-M16x35   |
| AFM90-WN0604Z-D100-A32-Z09-H                       | ●                      | 100   | 9    | 32   | 50 | 5.7  |   |   |  |   |
| AFM90-WN0806Z-D050-A22-Z04-H                       | ●                      | 50  | 4    | 22   | 40 | 7.7  | WNHU 0806..                               | 4015-M4x11                                  | 80-T15                                     | 2508-M10x30   |
| AFM90-WN0806Z-D063-A22-Z05-H                       | ●                      | 63  | 5    | 22   | 40 | 7.7  |   |   |  | 2510-M12x35   |
| AFM90-WN0806Z-D080-A27-Z06-H                       | ●                      | 80  | 6    | 27   | 50 | 7.7  |   |   |  | 2514-M16x35   |
| AFM90-WN0806Z-D100-A32-Z08-H                       | ●                      | 100   | 8    | 32   | 50 | 7.7  |   |   |  | -   |
| AFM90-WN0806Z-D125-B40-Z10                         | ●                      | 125   | 10   | 40   | 63 | 7.7  |   |   |  |   |
| AFM90-WN0806Z-D160-C40-Z12                         | ●                      | 160   | 12   | 40   | 63 | 7.7  |   |   |  |   |

ZCC Ucuca Uygundur. / Compatible with ZCC Insert. / Kompatibel mit ZCC Wendeplatten.

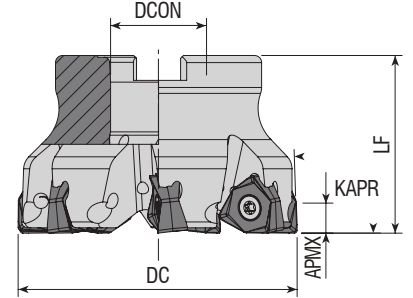

| Takım Kodu<br>Ordering Code<br>Bestell-Bezeichnung | Stok<br>Stock<br>Lager | Takım Ölçüleri (mm)<br>Dimension (mm)<br>Abmessung (mm) |      |      |    |      | Kesici Uç<br>Insert<br>Wendeschneidplatte | Yedek Parçaları / Spare Parts / Ersatzteile |  |   |
|--|------------------------|---|------|------|----|------|---|---|--|---|
|  |                        | DC  | ZEFP | DCON | LF | APMX |   | Sıkma Vidası<br>Screw<br>Schraube           | Tork Anahtar<br>Torx Key<br>Torx-Schlüssel | Montaj Vidası<br>Mounting Screw<br>Befestigungsschraube |
| AFM90-WN0806-D050-A16-Z04-H                        | ●                      | 50  | 4    | 16   | 40 | 8    | WNMX 080608                               | 1615-M5x14                                  | 80-T15                                     | 2506-M8x30  |
| AFM90-WN0806-D063-A22-Z05-H                        | ●                      | 63  | 5    | 22   | 40 | 8    |   |   |  | 2508-M10x30   |
| AFM90-WN0806-D080-A27-Z07-H                        | ●                      | 80  | 7    | 27   | 50 | 8    |   |   |  | 2510-M12x35   |

R: Sağ / Right / Rechts L: Sol / Left / Links

● Stokta / In Stock / Auf Lager ○ Stokta Yok / Non Stock Item / Kein Lagerartikel, Lieferzeit auf Anfrage  
KYCR-JD Ucuca Uygundur. / Compatible with KYCR-JD Insert. / Kompatibel mit KYCR-JD Wendeplatten.

Sipariş Örneği/Ordering Example/Bestellbeispiel

1 ad./pcs./stück AFM90-WN0604Z-D040-A16-Z04-H

Kesme Hesabı : S 377 / Cutting Calculation : P 377 / Schnittberechnung : P 377

Montaj Ölçüleri : S 374 / Mounting Reference : P 374 / Montagehinweis : P374

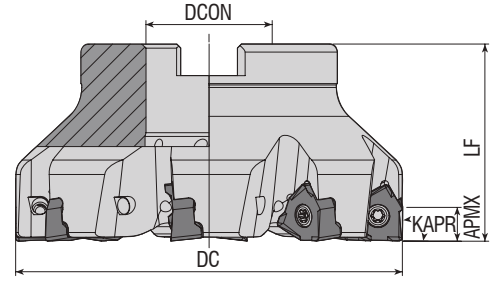

| Takım Kodu<br>Ordering Code<br>Bestell-Bezeichnung | Stok<br>Stock<br>Lager | Takım Ölçüleri (mm)<br>Dimension (mm)<br>Abmessung (mm) |      |      |    |      | Kesici Uç<br>Insert<br>Wendeschneidplatte | Yedek Parçaları / Spare Parts / Ersatzteile |  |   |            |        |             |
|--|------------------------|---|------|------|----|------|---|---|--|---|------------|--------|-------------|
|  |                        | DC  | ZEFP | DCON | LF | APMX |   | Sıkma Vidası<br>Screw<br>Schraube           | Tork Anahtar<br>Torx Key<br>Torx-Schlüssel | Montaj Vidası<br>Mounting Screw<br>Befestigungsschraube |            |        |             |
| AFM90-XN0403-D040-A16-Z05-H                        | ●                      | 40  | 5    | 16   | 40 | 4    | XNEX 0403..                               | 3008-M2.5x6                                 | 82-T08                                     | 2506-M8x30  |            |        |             |
| AFM90-XN0806-D050-A22-Z04-H                        | ●                      | 50  | 4    | 22   | 40 | 7.5  |   |   |  | XNEX 0806..   | 4015-M4x11 | 80-T15 | 2508-M10x30 |
| AFM90-XN0806-D063-A22-Z05-H                        | ●                      | 63  | 5    | 22   | 40 | 7.5  |   |   |  |   |            |        | 2510-M12x35 |
| AFM90-XN0806-D080-A27-Z07-H                        | ●                      | 80  | 7    | 27   | 50 | 7.5  |   |   |  |   |            |        | 2514-M16x35 |
| AFM90-XN0806-D100-A32-Z08-H                        | ●                      | 100   | 8    | 32   | 50 | 7.5  |   |   |  |   |            |        |             |

SC Ucuna Uygunur. / Compatible with SC Insert. / Kompatibel mit SC Wendeplatten.

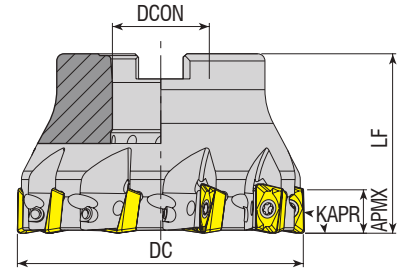

| Takım Kodu<br>Ordering Code<br>Bestell-Bezeichnung | Stok<br>Stock<br>Lager | Takım Ölçüleri (mm)<br>Dimension (mm)<br>Abmessung (mm) |      |      |    |      | Kesici Uç<br>Insert<br>Wendeschneidplatte | Yedek Parçaları / Spare Parts / Ersatzteile |  |   |
|--|------------------------|---|------|------|----|------|---|---|--|---|
|  |                        | DC  | ZEFP | DCON | LF | APMX |   | Sıkma Vidası<br>Screw<br>Schraube           | Tork Anahtar<br>Torx Key<br>Torx-Schlüssel | Montaj Vidası<br>Mounting Screw<br>Befestigungsschraube |
| AFM90-X012-D040-A16-Z05-H                          | ●                      | 40  | 5    | 16   | 40 | 11   | XO.. 1204..                               | 3010-M3.5x9                                 | 82-T10                                     | 2506-M8x30  |
| AFM90-X012-D050-A22-Z07-H                          | ●                      | 50  | 7    | 22   | 40 | 11   |   |   |  | 2508-M10x30   |
| AFM90-X012-D063-A22-Z08-H                          | ●                      | 63  | 8    | 22   | 40 | 11   |   |   |  | 2510-M12x35   |
| AFM90-X012-D080-A27-Z10-H                          | ●                      | 80  | 10   | 27   | 50 | 11   |   |   |  | 2514-M16x35   |
| AFM90-X012-D100-A32-Z12-H                          | ●                      | 100   | 12   | 32   | 50 | 11   |   |   |  |   |

R: Sağ / Right / Rechts L: Sol / Left / Links

● Stokta / In Stock / Auf Lager ○ Stokta Yok / Non Stock Item / Kein Lagerartikel, Lieferzeit auf Anfrage

SC Ucuna Uygunur. / Compatible with SC Insert. / Kompatibel mit SC Wendeplatten.

Sipariş Örneği/Ordering Example/Bestellbeispiel

1 ad./pcs./stück AFM90-XN0403-D040-A16-Z05-H

Kesme Hesabı : S 377 / Cutting Calculation : P 377 / Schnittberechnung : P 377

Montaj Ölçüleri : S 374 / Mounting Reference : P 374 / Montagehinweis : P 374

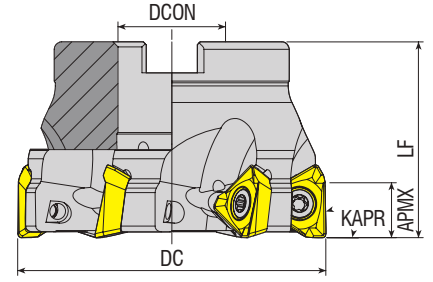

| Takım Kodu<br>Ordering Code<br>Bestell-Bezeichnung | Stok<br>Stock<br>Lager | Takım Ölçüleri (mm)<br>Dimension (mm)<br>Abmessung (mm) |      |      |    |      | Kesici Uç<br>Insert<br>Wendeschneidplatte | Yedek Parçaları / Spare Parts / Ersatzteile |  |   |
|--|------------------------|---|------|------|----|------|---|---|--|---|
|  |                        | DC  | ZEFP | DCON | LF | APMX |   | Sıkma Vidası<br>Screw<br>Schraube           | Tork Anahtar<br>Torx Key<br>Torx-Schlüssel | Montaj Vidası<br>Mounting Screw<br>Befestigungsschraube |
| AFM90-3P1004-D040-A16-Z05-H                        | ●                      | 40  | 5    | 16   | 40 | 7    | 3PKT 1004..                               | 1108-M2.5x6                                 | 82-T08                                     | 2506-M8x30  |
| AFM90-3P1004-D050-A22-Z06-H                        | ●                      | 50  | 6    | 22   | 40 | 7    |   |   |  |   |
| AFM90-3P1505-D050-A22-Z04-H                        | ●                      | 50  | 4    | 22   | 40 | 11   | 3PKT 1505..                               | 1115-M4x10                                  | 80-T15                                     | 2508-M10x30   |
| AFM90-3P1505-D050-A22-Z05-H                        | ●                      | 50  | 5    | 22   | 40 | 11   |   |   |  |   |
| AFM90-3P1505-D063-A22-Z04-H                        | ●                      | 63  | 4    | 22   | 40 | 11   |   |   |  |   |
| AFM90-3P1505-D063-A22-Z06-H                        | ●                      | 63  | 6    | 22   | 40 | 11   |   |   |  |   |
| AFM90-3P1505-D080-A27-Z07-H                        | ●                      | 80  | 7    | 27   | 50 | 11   |   |   |  |   |
| AFM90-3P1505-D100-A32-Z08-H                        | ●                      | 100   | 8    | 32   | 50 | 11   |   |   |  |   |
| AFM90-3P1505-D125-B40-Z10                          | ●                      | 125   | 10   | 40   | 63 | 11   | 3PKT 1906..                               | 1120-M4.5x12                                | 80-T20                                     | 2514-M16x35   |
| <b>new</b> AFM90-3P1906-D080-A27-Z07-H             | ●                      | 80  | 7    | 27   | 50 | 15   |   |   |  |   |
| <b>new</b> AFM90-3P1906-D100-A32-Z08-H             | ●                      | 100   | 8    | 32   | 50 | 15   |   |   |  |   |
| <b>new</b> AFM90-3P1906-D125-B40-Z10               | ●                      | 125   | 10   | 40   | 63 | 15   |   |   |  |   |

TGTC Ucuna Uygunudur. / Compatible with TGTC Insert. / Kompatibel mit TGTC Wendeplatten.

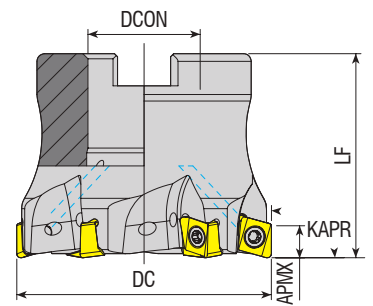

| Takım Kodu<br>Ordering Code<br>Bestell-Bezeichnung | Stok<br>Stock<br>Lager | Takım Ölçüleri (mm)<br>Dimension (mm)<br>Abmessung (mm) |      |      |    |      | Kesici Uç<br>Insert<br>Wendeschneidplatte | Yedek Parçaları / Spare Parts / Ersatzteile |  |   |
|--|------------------------|---|------|------|----|------|---|---|--|---|
|  |                        | DC  | ZEFP | DCON | LF | APMX |   | Sıkma Vidası<br>Screw<br>Schraube           | Tork Anahtar<br>Torx Key<br>Torx-Schlüssel | Montaj Vidası<br>Mounting Screw<br>Befestigungsschraube |
| AFM90-4N06-D040-A16-Z05-H                          | ●                      | 40  | 5    | 16   | 40 | 6    | 4NKT 0603..                               | 1108-M3x6.8                                 | 82-T08                                     | 2506-M8x30  |
| AFM90-4N06-D050-A22-Z06-H                          | ●                      | 50  | 6    | 22   | 40 | 6    |   |   |  | 2508-M10x30   |

R: Sağ / Right / Rechts L: Sol / Left / Links

● Stokta / In Stock / Auf Lager ○ Stokta Yok / Non Stock Item / Kein Lagerartikel, Lieferzeit auf Anfrage  
TGTC Ucuna Uygunudur. / Compatible with TGTC Insert. / Kompatibel mit TGTC Wendeplatten.

Sipariş Örneği/Ordering Example/Bestellbeispiel

1 ad./pcs./stück AFM90-3P1004-D040-A16-Z05-H

Kesme Hesabı : S 377 / Cutting Calculation : P 377 / Schnittberechnung : P 377

Montaj Ölçüleri : S 374 / Mounting Reference : P 374 / Montagehinweis : P374



KAPR=90°

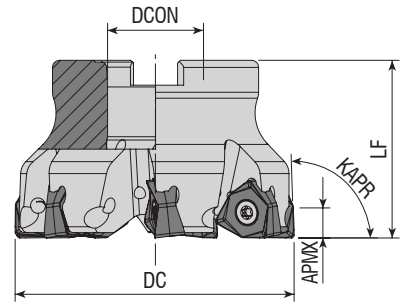

| Takım Kodu<br>Ordering Code<br>Bestell-Bezeichnung | Stok<br>Stock<br>Lager | Takım Ölçüleri (mm)<br>Dimension (mm)<br>Abmessung (mm) |      |      |    |      | Kesici Uç<br>Insert<br>Wendeschneidplatte | Yedek Parçaları / Spare Parts / Ersatzteile |  |   |
|--|------------------------|---|------|------|----|------|---|---|--|---|
|  |                        | DC  | ZEPF | DCON | LF | APMX |   | Sıkma Vidası<br>Screw<br>Schraube           | Tork Anahtar<br>Torx Key<br>Torx-Schlüssel | Montaj Vidası<br>Mounting Screw<br>Befestigungsschraube |
| AFM90-6N09-D050-A22-Z05-H                          | ○                      | 50  | 5    | 22   | 40 | 9    | 6NGU 0905..                               | 1115-M4x10                                  | 80-T15                                     | 2508-M10x30   |
| AFM90-6N09-D063-A22-Z06-H                          | ●                      | 63  | 6    | 22   | 40 | 9    |   |   |  | 2510-M12x35   |
| AFM90-6N09-D080-A27-Z07-H                          | ○                      | 80  | 7    | 27   | 50 | 9    |   |   |  | 2514-M16x35   |
| AFM90-6N09-D100-A32-Z08-H                          | ●                      | 100   | 8    | 32   | 50 | 9    |   |   |  | -   |
| AFM90-6N14-D050-A22-Z04-H                          | ○                      | 50  | 4    | 22   | 50 | 8.2  | 6NMU 1409..                               | 1120-M5x12                                  | 80-T20                                     | 2508-M10x30   |
| AFM90-6N14-D063-A22-Z05-H                          | ○                      | 63  | 5    | 22   | 40 | 8.2  |   |   |  | 2510-M12x35   |
| AFM90-6N14-D080-A27-Z07-H                          | ○                      | 80  | 7    | 27   | 50 | 8.2  |   |   |  | 2514-M16x35   |
| AFM90-6N14-D100-A32-Z07-H                          | ○                      | 100   | 7    | 32   | 50 | 8.2  |   |   |  | -   |
| AFM90-6N14-D125-B40-Z08                            | ○                      | 125   | 8    | 40   | 63 | 8.2  |   |   |  | -   |

R: Sağ / Right / Rechts L: Sol / Left / Links  
● Stokta / In Stock / Auf Lager ○ Stokta Yok / Non Stock Item / Kein Lagerartikel, Lieferzeit auf Anfrage  
MTSBH Ucuna Uygundur. / Compatible with MTSBH Insert. / Kompatibel mit MTSBH Wendeplatten.

Sipariş Örneği/Ordering Example/Bestellbeispiel  
1 ad./pcs./stück AFM90-6N09-D050-A22-Z05-H  
Kesme Hesabı : S 377 / Cutting Calculation : P 377 / Schnittberechnung : P 377  
Montaj Ölçüleri : S 374 / Mounting Reference : P 374 / Montagehinweis : P 374



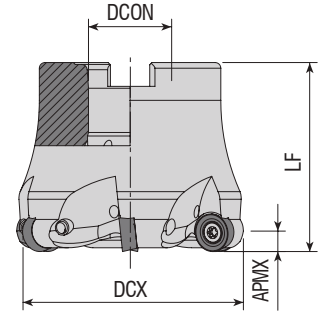

| Takım Kodu<br>Ordering Code<br>Bestell-Bezeichnung | Stok<br>Stock<br>Lager | Takım Ölçüleri (mm)<br>Dimension (mm)<br>Abmessung (mm) |      |      |    |      | Kesici Uç<br>Insert<br>Wendeschneidplatte | Yedek Parçaları / Spare Parts / Ersatzteile |  |   |        |             |
|--|------------------------|---|------|------|----|------|---|---|--|---|--------|-------------|
|  |                        | DCX   | ZEFP | DCON | LF | APMX |   | Sıkma Vidası<br>Screw<br>Schraube           | Tork Anahtar<br>Torx Key<br>Torx-Schlüssel | Montaj Vidası<br>Mounting Screw<br>Befestigungsschraube |        |             |
| AFMR-RC10T3-D040-A16-Z04-H                         | ●                      | 40  | 4    | 16   | 40 | 5    | RC.. 10T3..                               |   |  | 2406-M8x30  |        |             |
| AFMR-RC10T3-D050-A22-Z05-H                         | ●                      | 50  | 5    | 22   | 50 | 5    |   |   |  | 4015-M4x11  | 80-T15 | 2508-M10x30 |
| AFMR-RC10T3-D063-A22-Z06-H                         | ●                      | 63  | 6    | 22   | 50 | 5    |   |   |  |   |        |             |

ZCC Ucuna Uygunudur. / Compatible with ZCC Insert. / Kompatibel mit ZCC Wendeplatten.

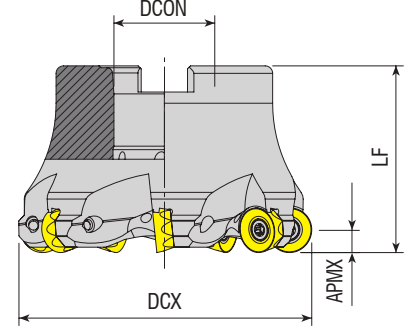

| Takım Kodu<br>Ordering Code<br>Bestell-Bezeichnung | Stok<br>Stock<br>Lager | Takım Ölçüleri (mm)<br>Dimension (mm)<br>Abmessung (mm) |      |      |    |      | Kesici Uç<br>Insert<br>Wendeschneidplatte | Yedek Parçaları / Spare Parts / Ersatzteile |  |   |        |             |
|--|------------------------|---|------|------|----|------|---|---|--|---|--------|-------------|
|  |                        | DCX   | ZEFP | DCON | LF | APMX |   | Sıkma Vidası<br>Screw<br>Schraube           | Tork Anahtar<br>Torx Key<br>Torx-Schlüssel | Montaj Vidası<br>Mounting Screw<br>Befestigungsschraube |        |             |
| AFMR-RC1204-D040-A16-Z04-H                         | ●                      | 40  | 4    | 16   | 40 | 6    | RC.. 1204..                               |   |  | 2506-M8x30  |        |             |
| AFMR-RC1204-D050-A22-Z05-H                         | ●                      | 50  | 5    | 22   | 50 | 6    |   |   |  | 4015-M3.5x11  | 80-T15 | 2508-M10x30 |
| AFMR-RC1204-D052-A22-Z05-H                         | ●                      | 52  | 5    | 22   | 50 | 6    |   |   |  |   |        | 2510-M12x35 |
| AFMR-RC1204-D063-A22-Z06-H                         | ●                      | 63  | 6    | 22   | 50 | 6    |   |   |  |   |        |             |
| AFMR-RC1204-D063-A27-Z06-H                         | ●                      | 80  | 6    | 27   | 50 | 6    |   |   |  |   |        |             |
| AFMR-RC1204-D080-A27-Z07-H                         | ●                      | 80  | 7    | 27   | 50 | 6    |   |   |  |   |        |             |

R: Sağ / Right / Rechts L: Sol / Left / Links

● Stokta / In Stock / Auf Lager ○ Stokta Yok / Non Stock Item / Kein Lagerartikel, Lieferzeit auf Anfrage  
SNDVK Ucuna Uygunudur. / Compatible with SNDVK Insert. / Kompatibel mit SNDVK Wendeplatten.

Sipariş Örneği/Ordering Example/Bestellbeispiel

1 ad./pcs./stück AFMR-RC10T3-D040-A16-Z04-H

Kesme Hesabı : S 377 / Cutting Calculation : P 377 / Schnittberechnung : P 377

Montaj Ölçüleri : S 374 / Mounting Reference : P 374 / Montagehinweis : P374



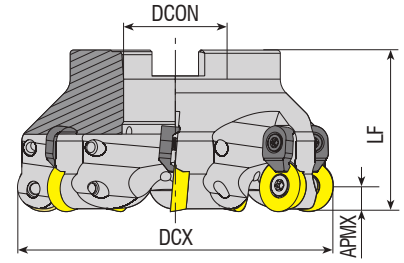

| Takım Kodu<br>Ordering Code<br>Bestell-Bezeichnung | Stok<br>Stock<br>Lager | Takım Ölçüleri (mm)<br>Dimension (mm)<br>Abmessung (mm) |      |      |    |      | Kesici Uç<br>Insert<br>Wendeschneidplatte | Yedek Parçaları / Spare Parts / Ersatzteile |   |  |  |   |              |        |              |        |            |
|--|------------------------|---|------|------|----|------|---|---|---|--|--|---|--------------|--------|--------------|--------|------------|
|  |                        | DCX   | ZEPF | DCON | LF | APMX |   | Sıkma Vidası<br>Screw<br>Schraube           | Baskı Parçası<br>Wedge Clamp<br>Spannpratze | Baskı Vidası<br>Clamp Screw<br>Klemmschraube | Tork Anahtar<br>Torx Key<br>Torx-Schlüssel | Montaj Vidası<br>Mounting Screw<br>Befestigungsschraube |              |        |              |        |            |
| AFMR-RD0702-D050-A22-Z06-H                         | ●                      | 50  | 6    | 22   | 40 | 3.5  | RD.. 0702                                 | 3008-M2.5x6                                 | -   | -  | 82-T08                                     | 2407-M10x30   |              |        |              |        |            |
| AFMR-RD0803-D050-A22-Z05-H                         | ●                      | 50  | 5    | 22   | 40 | 4    | RD.. 0803                                 | 3008-M3x8                                   | -   | -  | 82-T08                                     | 2407-M10x30   |              |        |              |        |            |
| new AFMRC-RD1003-D040-A16-Z04-H                    | ●                      | 40  | 4    | 16   | 40 | 5    | RD.. 1003                                 | 4015-M3.5x11                                | -   | -  | 82-T08                                     | 2406-M8x30  |              |        |              |        |            |
| AFMR-RD1003-D040-A16-Z05-H                         | ●                      | 40  | 5    | 16   | 40 | 5    |   |   |   |  |  | 2508-M10x30   |              |        |              |        |            |
| AFMRC-RD1003-D050-A22-Z05-H                        | ●                      | 50  | 5    | 22   | 50 | 5    |   |   |   |  |  | 2510-M12X35   |              |        |              |        |            |
| AFMRC-RD1003-D052-A22-Z05                          | ●                      | 52  | 5    | 22   | 50 | 5    |   |   |   |  |  | 2514-M16x35   |              |        |              |        |            |
| AFMRC-RD1003-D063-A22-Z06-H                        | ●                      | 63  | 6    | 22   | 50 | 5    |   |   |   |  |  | -   |              |        |              |        |            |
| new AFMRC-RD1003-D066-A27-Z07-H                    | ●                      | 66  | 7    | 27   | 50 | 5    |   |   |   |  |  | -   |              |        |              |        |            |
| AFMRC-RD1003-D080-A27-Z07-H                        | ●                      | 80  | 7    | 27   | 50 | 5    |   |   |   |  |  | -   |              |        |              |        |            |
| AFMRC-RD1003-D100-A32-Z08-H                        | ●                      | 100   | 8    | 32   | 50 | 5    |   |   |   |  |  | -   |              |        |              |        |            |
| new AFMR-RD1004-D063-A22-Z06-H                     | ●                      | 63  | 6    | 22   | 50 | 50   | RD.. 1004                                 | 4515-M4x8                                   | -   | -  | 82-T08                                     | 2406-M8x30  |              |        |              |        |            |
| new AFMRC-RD10T3-D040-A16-Z05-H                    | ●                      | 40  | 5    | 16   | 40 | 5    | RD.. 10T3                                 | 4015-M3.5x9                                 | -   | -  | 82-T08                                     | 2406-M8x30  |              |        |              |        |            |
| new AFMRC-RD10T3-D042-A16-Z05-H                    | ●                      | 42  | 5    | 16   | 40 | 5    |   |   |   |  |  | 2508-M10x30   |              |        |              |        |            |
| AFMRC-RD10T3-D050-A22-Z05-H                        | ●                      | 50  | 5    | 22   | 50 | 5    |   |   |   |  |  | -   |              |        |              |        |            |
| AFMRC-RD10T3-D052-A22-Z05-H                        | ●                      | 52  | 5    | 22   | 40 | 5    |   |   |   |  |  | -   |              |        |              |        |            |
| new AFMRC-RD10T3-D052-A22-Z06-H                    | ●                      | 52  | 6    | 22   | 40 | 5    |   |   |   |  |  | -   |              |        |              |        |            |
| new AFMRC-RD10T3-D063-A22-Z06-H                    | ●                      | 63  | 6    | 22   | 50 | 5    |   |   |   |  |  | -   |              |        |              |        |            |
| new AFMR-RD12T3-D066-A27-Z06-H                     | ●                      | 66  | 6    | 22   | 50 | 50   |   |   |   |  |  | RD.. 12T3   | 4015-M3.5x11 | ACK-15 | 4015-M3.5x11 | 80-T15 | 2406-M8x30 |
| AFMRC-RD12T3-D040-A16-Z04-H                        | ●                      | 40  | 4    | 27   | 50 | 6    |   |   |   |  |  | -   |              |        |              |        |            |
| AFMRC-RD12T3-D050-A22-Z05-H                        | ●                      | 50  | 5    | 16   | 40 | 6    | -   |   |   |  |  |   |              |        |              |        |            |
| AFMRC-RD12T3-D052-A22-Z05-H                        | ●                      | 52  | 5    | 22   | 50 | 6    | -   |   |   |  |  |   |              |        |              |        |            |
| AFMRC-RD12T3-D063-A22-Z06-H                        | ●                      | 63  | 6    | 22   | 50 | 6    | -   |   |   |  |  |   |              |        |              |        |            |
| AFMRC-RD12T3-D080-A27-Z07-H                        | ●                      | 80  | 7    | 22   | 50 | 6    | -   |   |   |  |  |   |              |        |              |        |            |
| AFMRC-RD12T3-D100-A32-Z08-H                        | ●                      | 100   | 8    | 27   | 50 | 6    | -   |   |   |  |  |   |              |        |              |        |            |
| AFMRC-RD12T3-D125-B40-Z09                          | ●                      | 125   | 9    | 32   | 50 | 6    | -   |   |   |  |  |   |              |        |              |        |            |
| new AFMRC-RD1204-D040-A16-Z04-H                    | ●                      | 40  | 4    | 40   | 63 | 6    | RD.. 1204                                 | 4015-M4.5x11                                | ACK-05                                      | 4015-M4x11                                   | 82-T08                                     | 2406-M8x30  |              |        |              |        |            |
| new AFMRC-RD1204-D042-A16-Z04-H                    | ●                      | 42  | 4    | 16   | 40 | 6    |   |   |   |  |  | 2508-M10x30   |              |        |              |        |            |
| AFMRC-RD1204-D050-A22-Z05-H                        | ●                      | 50  | 5    | 16   | 40 | 6    |   |   |   |  |  | 2510-M12X35   |              |        |              |        |            |
| AFMRC-RD1204-D052-A22-Z05-H                        | ●                      | 52  | 5    | 22   | 50 | 6    |   |   |   |  |  | 2514-M16x35   |              |        |              |        |            |
| AFMRC-RD1204-D063-A22-Z06-H                        | ●                      | 63  | 6    | 22   | 50 | 6    |   |   |   |  |  | -   |              |        |              |        |            |
| AFMRC-RD1204-D080-A27-Z07-H                        | ●                      | 80  | 7    | 22   | 50 | 6    |   |   |   |  |  | -   |              |        |              |        |            |
| AFMRC-RD1204-D100-A32-Z07-H                        | ●                      | 100   | 7    | 27   | 50 | 6    |   |   |   |  |  | -   |              |        |              |        |            |
| AFMRC-RD1204-D100-A32-Z08-H                        | ●                      | 100   | 8    | 32   | 50 | 6    |   |   |   |  |  | -   |              |        |              |        |            |
| AFMRC-RD1604-D050-A22-Z04-H                        | ●                      | 50  | 4    | 32   | 50 | 6    | RD.. 1604                                 | 4015-M4.5x11                                | ACK-05                                      | 4015-M4x11                                   | 82-T08                                     | 2408-M10x30   |              |        |              |        |            |
| AFMRC-RD1604-D052-A22-Z04-H                        | ●                      | 52  | 4    | 22   | 50 | 8    |   |   |   |  |  | 2508-M10x30   |              |        |              |        |            |
| AFMRC-RD1604-D063-A22-Z05-H                        | ●                      | 63  | 5    | 22   | 50 | 8    |   |   |   |  |  | 2510-M12X35   |              |        |              |        |            |
| AFMRC-RD1604-D066-A22-Z05-H                        | ●                      | 66  | 5    | 22   | 50 | 8    |   |   |   |  |  | 2514-M16x35   |              |        |              |        |            |
| AFMRC-RD1604-D066-A27-Z05-H                        | ●                      | 66  | 5    | 22   | 50 | 8    |   |   |   |  |  | -   |              |        |              |        |            |
| AFMRC-RD1604-D080-A27-Z06-H                        | ●                      | 80  | 6    | 27   | 50 | 8    |   |   |   |  |  | -   |              |        |              |        |            |
| AFMRC-RD1604-D100-A32-Z07-H                        | ●                      | 100   | 7    | 27   | 50 | 8    |   |   |   |  |  | -   |              |        |              |        |            |
| AFMRC-RD1604-D125-B40-Z07                          | ●                      | 125   | 7    | 32   | 50 | 8    |   |   |   |  |  | -   |              |        |              |        |            |
| AFMRC-RD1604-D160-C40-Z08                          | ●                      | 160   | 8    | 40   | 63 | 8    | -   |   |   |  |  |   |              |        |              |        |            |

R: Sağ / Right / Rechts L: Sol / Left / Links

● Stokta / In Stock / Auf Lager ○ Stokta Yok / Non Stock Item / Kein Lagerartikel, Lieferzeit auf Anfrage  
ISO Ucuna Uygunudur. / Compatible with ISO Insert. / Kompatibel mit ISO Wendeplatten.

Sipariş Örneği/Ordering Example/Bestellbeispiel

1 ad./pcs./stück AFMR-RD0702-D050-A22-Z06-H

Kesme Hesabı : S 377 / Cutting Calculation : P 377 | Schnittberechnung : P 377

Montaj Ölçüleri : S 374 / Mounting Reference : P 374 | Montagehinweis : P 374

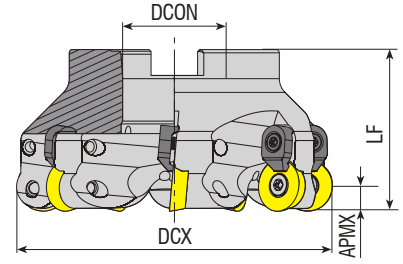
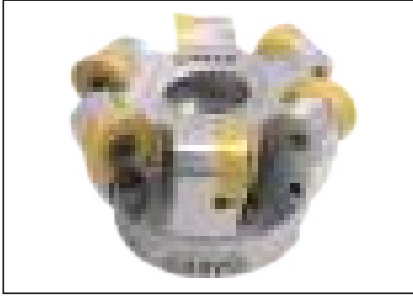

| Takım Kodu<br>Ordering Code<br>Bestell-Bezeichnung | Stok<br>Stock<br>Lager | Takım Ölçüleri (mm)<br>Dimension (mm)<br>Abmessung (mm) |      |      |    |      | Kesici Uç<br>Insert<br>Wendeschneidplatte | Yedek Parçaları / Spare Parts / Ersatzteile |   |  |  |   |
|--|------------------------|---|------|------|----|------|---|---|---|--|--|---|
|  |                        | DC  | ZEFP | DCON | LF | APMX |   | Sıkma Vidası<br>Screw<br>Schraube           | Baskı Parçası<br>Wedge Clamp<br>Spannpratze | Baskı Vidası<br>Clamp Screw<br>Klemmschraube | Tork Anahtar<br>Torx Key<br>Torx-Schlüssel | Montaj Vidası<br>Mounting Screw<br>Befestigungsschraube |
| AFMRC-R020-D063-A22-Z05-H                          | ●                      | 63  | 5    | 22   | 50 | 10   | ROMX 2006                                 |   |   |  |  |   |
| AFMRC-R020-D080-A27-Z06-H                          | ●                      | 80  | 6    | 27   | 50 | 10   |   |   |   |  |  |   |

WLTR Ucuna Uygunur. / Compatible with WLTR Insert. / Kompatibel mit WLTR Wendeplatten.

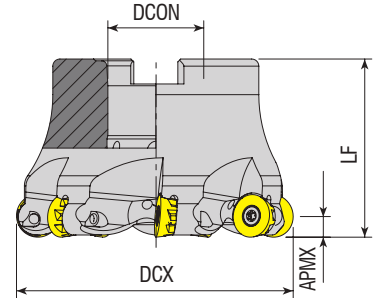

| Takım Kodu<br>Ordering Code<br>Bestell-Bezeichnung | Stok<br>Stock<br>Lager | Takım Ölçüleri (mm)<br>Dimension (mm)<br>Abmessung (mm) |      |      |    |      | Kesici Uç<br>Insert<br>Wendeschneidplatte | Yedek Parçaları / Spare Parts / Ersatzteile |  |   |
|--|------------------------|---|------|------|----|------|---|---|--|---|
|  |                        | DCX   | ZEFP | DCON | LF | APMX |   | Sıkma Vidası<br>Screw<br>Schraube           | Tork Anahtar<br>Torx Key<br>Torx-Schlüssel | Montaj Vidası<br>Mounting Screw<br>Befestigungsschraube |
| AFMR-RP10T3-D063-A22-Z06-H                         | ●                      | 63  | 6    | 22   | 40 | 5    | RPNX 10T3..                               |   |  |   |
| AFMR-RP10T3-D080-A27-Z07-H                         | ●                      | 80  | 7    | 27   | 50 | 5    |   |   |  |   |
| AFMR-RP1204-D040-A16-Z04-H                         | ●                      | 40  | 4    | 16   | 40 | 6    | RPNX 1204..                               |   |  |   |
| AFMR-RP1204-D080-A27-Z07-H                         | ●                      | 80  | 7    | 27   | 50 | 6    |   |   |  |   |

R: Sağ / Right / Rechts L: Sol / Left / Links

● Stokta / In Stock / Auf Lager ○ Stokta Yok / Non Stock Item / Kein Lagerartikel, Lieferzeit auf Anfrage  
CRTZT Ucuna Uygunur. / Compatible with CRTZT Insert. / Kompatibel mit CRTZT Wendeplatten.





Sipariş Örneği/Ordering Example/Bestellbeispiel

1 ad./pcs./stück AFMRC-R020-D063-A22-Z05-H

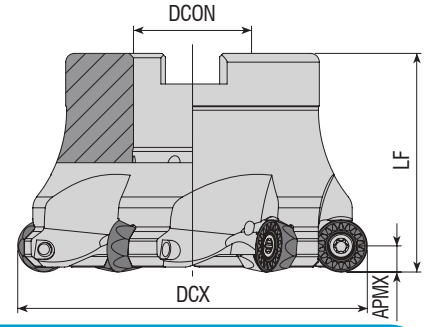
Kesme Hesabı : S 377 / Cutting Calculation : P 377 / Schnittberechnung : P 377







Montaj Ölçüleri : S 374 / Mounting Reference : P 374 / Montagehinweis : P 374

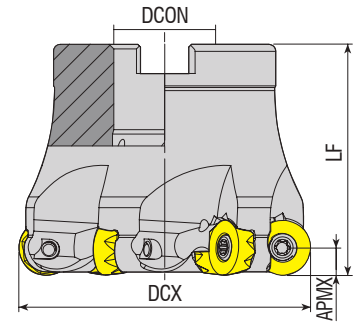

| Takım Kodu<br>Ordering Code<br>Bestell-Bezeichnung | Stok<br>Stock<br>Lager | Takım Ölçüleri (mm)<br>Dimension (mm)<br>Abmessung (mm) |      |      |    |      | Kesici Uç<br>Insert<br>Wendeschneidplatte   | Yedek Parçaları / Spare Parts / Ersatzteile   |   |   |  |
|--|------------------------|---|------|------|----|------|---|---|---|---|--|
|  |                        | DCX   | ZEFP | DCON | LF | APMX |   | Sıkma Vidası<br>Screw<br>Schraube   | Tork Anahtar<br>Torx Key<br>Torx-Schlüssel  | Montaj Vidası<br>Mounting Screw<br>Befestigungsschraube                             |  |
| <b>new</b> AFMR-RP1204M-D042-A16-Z04-H             | ●                      | 42  | 4    | 16   | 40 | 6    |  |  |  |  |  |
| AFMR-RP1204M-D050-A22-Z04-H                        | ●                      | 50  | 4    | 22   | 50 | 6    |   |   |   |   |  |
| AFMR-RP1204M-D052-A22-Z05-H                        | ●                      | 52  | 5    | 22   | 50 | 6    |   |   |   |   |  |
| AFMR-RP1204M-D063-A22-Z05-H                        | ●                      | 63  | 5    | 22   | 50 | 6    |   |   |   |   |  |
| AFMR-RP1204M-D080-A27-Z06-H                        | ●                      | 80  | 6    | 27   | 50 | 6    |   |   |   |   |  |

MTSBH Ucuna Uygunur. / Compatible with MTSBH Insert. / Kompatibel mit MTSBH Wendeplatten.



| Takım Kodu<br>Ordering Code<br>Bestell-Bezeichnung | Stok<br>Stock<br>Lager | Takım Ölçüleri (mm)<br>Dimension (mm)<br>Abmessung (mm) |      |      |    |      | Kesici Uç<br>Insert<br>Wendeschneidplatte   | Yedek Parçaları / Spare Parts / Ersatzteile   |   |   |  |
|--|------------------------|---|------|------|----|------|---|---|---|---|--|
|  |                        | DCX   | ZEFP | DCON | LF | APMX |   | Sıkma Vidası<br>Screw<br>Schraube   | Tork Anahtar<br>Torx Key<br>Torx-Schlüssel  | Montaj Vidası<br>Mounting Screw<br>Befestigungsschraube |  |
| AFMR-RY10-D040-A16-Z04-H                           | ●                      | 40  | 4    | 16   | 40 | 5    |  |  |  | 2406-M8x30  |  |
| AFMR-RY10-D040-A16-Z05-H                           | ●                      | 40  | 5    | 16   | 40 | 5    |   |   |   | 2506-M8x30  |  |
| AFMR-RY10-D050-A22-Z05-H                           | ●                      | 50  | 5    | 22   | 50 | 5    |   |   |   | 2508-M10x30   |  |
| AFMR-RY10-D063-A22-Z06-H                           | ●                      | 63  | 6    | 22   | 50 | 5    |   |   |   | 2406-M8x30  |  |
| AFMR-RY12-D040-A16-Z04-H                           | ●                      | 40  | 4    | 16   | 40 | 6    |   |   |   | 2508-M10x30   |  |
| AFMR-RY12-D050-A22-Z05-H                           | ●                      | 50  | 5    | 22   | 50 | 6    |  |  |  | 2406-M8x30  |  |
| AFMR-RY12-D052-A22-Z05-H                           | ●                      | 52  | 5    | 22   | 50 | 6    |   |   |   | 2508-M10x30   |  |
| AFMR-RY12-D063-A22-Z06-H                           | ●                      | 63  | 6    | 22   | 50 | 6    |   |   |   | 2510-M12x35   |  |
| AFMR-RY12-D080-A27-Z06-H                           | ●                      | 80  | 6    | 27   | 50 | 6    |   |   |   | 2514-M16x35   |  |
| AFMR-RY12-D100-A32-Z07-H                           | ●                      | 100   | 7    | 32   | 50 | 6    |   |   |   |   |  |

R: Sağ / Right / Rechts L: Sol / Left / Links

● Stokta / In Stock / Auf Lager ○ Stokta Yok / Non Stock Item / Kein Lagerartikel, Lieferzeit auf Anfrage

TGTC Ucuna Uygunur. / Compatible with TGTC Insert. / Kompatibel mit TGTC Wendeplatten.

Sipariş Örneği/Ordering Example/Bestellbeispiel

1 ad./pcs./stück AFMR-RP1204M-D042-A16-Z04-H

Kesme Hesabı : S 377 / Cutting Calculation : P 377 / Schnittberechnung : P 377

Montaj Ölçüleri : S 374 / Mounting Reference : P 374 / Montagehinweis : P374

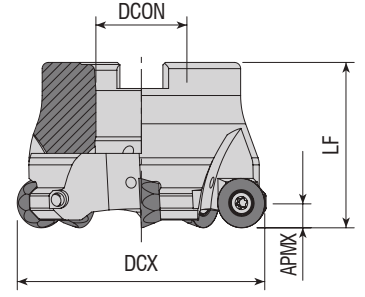

| Takım Kodu<br>Ordering Code<br>Bestell-Bezeichnung | Stok<br>Stock<br>Lager | Takım Ölçüleri (mm)<br>Dimension (mm)<br>Abmessung (mm) |      |      |    |      | Kesici Uç<br>Insert<br>Wendeschneidplatte | Yedek Parçaları / Spare Parts / Ersatzteile |  |   |        |             |
|--|------------------------|---|------|------|----|------|---|---|--|---|--------|-------------|
|  |                        | DCX   | ZEFP | DCON | LF | APMX |   | Sıkma Vidası<br>Screw<br>Schraube           | Tork Anahtar<br>Torx Key<br>Torx-Schlüssel | Montaj Vidası<br>Mounting Screw<br>Befestigungsschraube |        |             |
| AFMR-QP10T3-D040-A16-Z04-H                         | ●                      | 40  | 4    | 16   | 40 | 5    |   |   |  | 2506-M8x30  |        |             |
| AFMR-QP10T3-D050-A22-Z05-H                         | ●                      | 50  | 5    | 22   | 40 | 5    |   |   |  | 4015-M3.5x11  | 80-T15 | 2407-M10x30 |
| AFMR-QP10T3-D063-A22-Z06-H                         | ●                      | 63  | 6    | 22   | 40 | 5    |   |   |  |   |        |             |
| AFMR-QP1204-D050-A22-Z04-H                         | ●                      | 50  | 4    | 22   | 40 | 6    |   | 4015-M4x11                                  |  |   |        |             |
| AFMR-QP1204-D063-A22-Z05-H                         | ●                      | 63  | 5    | 22   | 40 | 6    |   |   |  |   |        |             |

SMTM Ucuna Uygunur. / Compatible with SMTM Insert. / Kompatibel mit SMTM Wendeplatten.

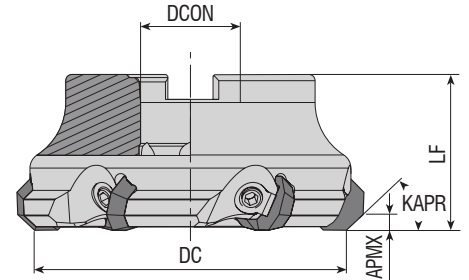

| Takım Kodu<br>Ordering Code<br>Bestell-Bezeichnung | Stok<br>Stock<br>Lager | Takım Ölçüleri (mm)<br>Dimension (mm)<br>Abmessung (mm) |      |      |    |      | Kesici Uç<br>Insert<br>Wendeschneidplatte | Yedek Parçaları / Spare Parts / Ersatzteile |  |   |   |                |          |             |
|--|------------------------|---|------|------|----|------|---|---|--|---|---|----------------|----------|-------------|
|  |                        | DC  | ZEFP | DCON | LF | APMX |   | Baskı Parçası<br>Wedge Clamp<br>Spannpratze | Baskı Vidası<br>Clamp Screw<br>Klemmschraube | Anahtar<br>Allen Key<br>Innensechskantschlüssel | Montaj Vidası<br>Mounting Screw<br>Befestigungsschraube |                |          |             |
| AFM43C-OF07-D063-A22-Z04                           | ●                      | 63  | 4    | 22   | 45 | 5    |   |   |  |   | 2508-M10x30   |                |          |             |
| AFM43C-OF07-D080-A27-Z05                           | ●                      | 80  | 5    | 27   | 50 | 5    |   |   |  |   | 2510-M12x35   |                |          |             |
| AFM43C-OF07-D100-A32-Z06                           | ●                      | 100   | 6    | 32   | 50 | 5    |   |   |  |   | ACK-11  | AKV-15-M8x1x20 | AAL-05-4 | 2514-M16x35 |
| AFM43C-OF07-D125-B40-Z08                           | ●                      | 125   | 8    | 40   | 63 | 5    |   |   |  |   |   |                |          |             |
| AFM43C-OF07-D160-C40-Z09                           | ●                      | 160   | 9    | 40   | 63 | 5    |   |   |  |   |   |                |          |             |

R: Sağ / Right / Rechts L: Sol / Left / Links

● Stokta / In Stock / Auf Lager ○ Stokta Yok / Non Stock Item / Kein Lagerartikel, Lieferzeit auf Anfrage  
ISO Ucuna Uygunur. / Compatible with ISO Insert. / Kompatibel mit ISO Wendeplatten.

Sipariş Örneği/Ordering Example/Bestellbeispiel

1 ad./pcs./stück AFMR-QP10T3-D040-A16-Z04-H

Kesme Hesabı : S 377 / Cutting Calculation : P 377 / Schnittberechnung : P 377

Montaj Ölçüleri : S 374 / Mounting Reference : P 374 / Montagehinweis : P374

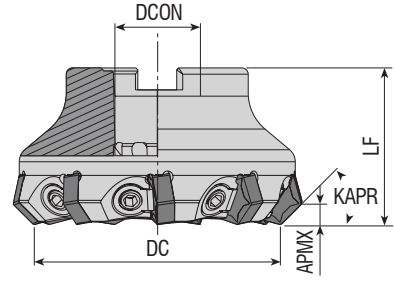

| Takım Kodu<br>Ordering Code<br>Bestell-Bezeichnung | Stok<br>Stock<br>Lager | Takım Ölçüleri (mm)<br>Dimension (mm)<br>Abmessung (mm) |      |      |    |      | Kesici Uç<br>Insert<br>Wendeschneidplatte | Yedek Parçaları / Spare Parts / Ersatzteile |  |   |   |
|--|------------------------|---|------|------|----|------|---|---|--|---|---|
|  |                        | DC  | ZEFP | DCON | LF | APMX |   | Baskı Parçası<br>Wedge Clamp<br>Spannpratze | Baskı Vidası<br>Clamp Screw<br>Klemmschraube | Anahtar<br>Allen Key<br>Innensechskantschlüssel | Montaj Vidası<br>Mounting Screw<br>Befestigungsschraube |
| AFM45C-HN0905-D063-A22-Z07                         | ●                      | 63  | 7    | 22   | 40 | 4.5  | HN.. 0905..                               | ACK-11                                      | AKV-15-M8x1x20                               | AAL-05-4  | 2508-M10x30   |
| AFM45C-HN0905-D080-A27-Z09                         | ●                      | 80  | 9    | 27   | 50 | 4.5  |   |   |  |   | 2510-M12x35   |
| AFM45C-HN0905-D100-A32-Z11                         | ●                      | 100   | 11   | 32   | 50 | 4.5  |   |   |  |   | 2514-M16x35   |
| AFM45C-HN0905-D125-B40-Z13                         | ●                      | 125   | 13   | 40   | 63 | 4.5  |   |   |  |   | -   |
| AFM45CL-HN0905-D125-B40-Z10                        | ●                      | 125   | 10   | 40   | 63 | 4.5  |   |   |  |   | -   |
| AFM45C-HN0905-D160-C40-Z15                         | ●                      | 160   | 15   | 40   | 63 | 4.5  |   |   |  |   | -   |

WDA-KNMTL Ucuna Uygunur. / Compatible with WDA-KNMTL Insert. / Kompatibel mit WDA-KNMTL Wendeplatten.

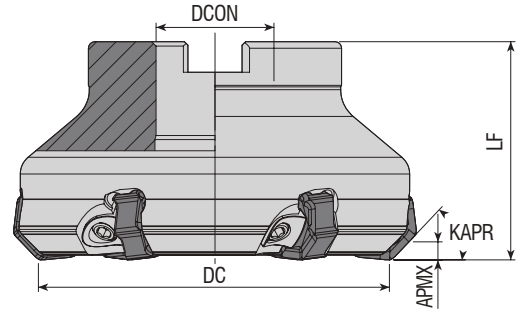

| Takım Kodu<br>Ordering Code<br>Bestell-Bezeichnung | Stok<br>Stock<br>Lager | Takım Ölçüleri (mm)<br>Dimension (mm)<br>Abmessung (mm) |      |      |    |      | Kesici Uç<br>Insert<br>Wendeschneidplatte | Yedek Parçaları / Spare Parts / Ersatzteile |  |   |   |
|--|------------------------|---|------|------|----|------|---|---|--|---|---|
|  |                        | DC  | ZEFP | DCON | LF | APMX |   | Baskı Parçası<br>Wedge Clamp<br>Spannpratze | Baskı Vidası<br>Clamp Screw<br>Klemmschraube | Anahtar<br>Allen Key<br>Innensechskantschlüssel | Montaj Vidası<br>Mounting Screw<br>Befestigungsschraube |
| AFM45C-XN0806-D063-A22-Z05                         | ●                      | 63  | 5    | 22   | 50 | 4.5  | XN0806..                                  | ACK-26                                      | AKV-26-M6x0.75x20                            | AAL-03-03                                       | 2508-M10x30   |
| AFM45C-XN0806-D080-A27-Z06                         | ●                      | 80  | 6    | 27   | 50 | 4.5  |   |   |  |   | 2510-M12x35   |
| AFM45C-XN0806-D100-A32-Z08                         | ●                      | 100   | 8    | 32   | 50 | 4.5  |   |   |  |   | 2514-M16x35   |
| AFM45C-XN0806-D125-B40-Z08                         | ●                      | 125   | 8    | 40   | 63 | 4.5  |   |   |  |   | -   |
| AFM45C-XN0806-D160-C40-Z10                         | ●                      | 160   | 10   | 40   | 63 | 4.5  |   |   |  |   | -   |
| AFM45C-XN0806-D200-C60-Z12                         | ●                      | 200   | 12   | 60   | 63 | 4.5  |   |   |  |   | -   |

R: Sağ / Right / Rechts L: Sol / Left / Links

● Stokta / In Stock / Auf Lager ○ Stokta Yok / Non Stock Item / Kein Lagerartikel, Lieferzeit auf Anfrage  
DJT Ucuna Uygunur. / Compatible with DJT Insert. / Kompatibel mit DJT Wendeplatten.

Sipariş Örneği/Ordering Example/Bestellbeispiel

1 ad./pcs./stück AFM45C-HN0905-D063-A22-Z07

Kesme Hesabı : S 377 / Cutting Calculation : P 377 / Schnittberechnung : P 377

Montaj Ölçüleri : S 374 / Mounting Reference : P 374 / Montagehinweis : P374

KAPR=75°

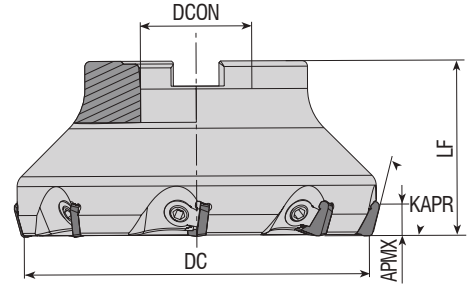

| Takım Kodu<br>Ordering Code<br>Bestell-Bezeichnung | Stok<br>Stock<br>Lager | Takım Ölçüleri (mm)<br>Dimension (mm)<br>Abmessung (mm) |     |      |    |      | Kesici Uç<br>Insert<br>Wendeschneidplatte | Yedek Parçaları / Spare Parts / Ersatzteile |  |   |   |                |             |
|--|------------------------|---|-----|------|----|------|---|---|--|---|---|----------------|-------------|
|  |                        | DC  | ZEP | DCON | LF | APMX |   | Baskı Parçası<br>Wedge Clamp<br>Spannpratze | Baskı Vidası<br>Clamp Screw<br>Klemmschraube | Anahtar<br>Allen Key<br>Innensechskantschlüssel | Montaj Vidası<br>Mounting Screw<br>Befestigungsschraube |                |             |
| AFM75C-SP12-D050-A22-Z04                           | ●                      | 50  | 4   | 22   | 42 | 8    | SPKN 1203..                               | ACK-10                                      | AKV-13-M8x1x16                               | AAL-05-4  | 2508-M10x30   |                |             |
| AFM75C-SP12-D063-A22-Z05                           | ●                      | 63  | 5   | 22   | 40 | 8    |   |   |  |   |   | AKV-22-M8x1x14 | 2510-M12x35 |
| AFM75C-SP12-D080-A27-Z06                           | ●                      | 80  | 6   | 27   | 50 | 8    |   |   |  |   |   | 2514-M16x35    |             |
| AFM75C-SP12-D100-A32-Z07                           | ●                      | 100   | 7   | 32   | 50 | 8    |   |   |  |   |   | -              |             |
| AFM75C-SP12-D125-B40-Z08                           | ●                      | 125   | 8   | 40   | 63 | 8    |   |   |  |   |   | -              |             |
| AFM75C-SP12-D160-C40-Z09                           | ●                      | 160   | 9   | 40   | 63 | 8    |   |   |  |   |   | -              |             |
| AFM75C-SP12-D200-C60-Z12                           | ●                      | 200   | 12  | 60   | 63 | 8    |   |   |  |   |   | -              |             |

ISO Ucuna Uygundur. / Compatible with ISO Insert. / Kompatibel mit ISO Wendepfatten.

KAPR=88°

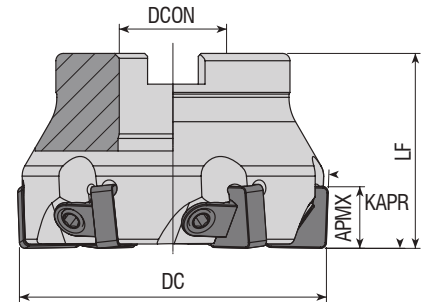

| Takım Kodu<br>Ordering Code<br>Bestell-Bezeichnung | Stok<br>Stock<br>Lager | Takım Ölçüleri (mm)<br>Dimension (mm)<br>Abmessung (mm) |     |      |    |      | Kesici Uç<br>Insert<br>Wendeschneidplatte | Yedek Parçaları / Spare Parts / Ersatzteile |  |   |   |             |
|--|------------------------|---|-----|------|----|------|---|---|--|---|---|-------------|
|  |                        | DC  | ZEP | DCON | LF | APMX |   | Baskı Parçası<br>Wedge Clamp<br>Spannpratze | Baskı Vidası<br>Clamp Screw<br>Klemmschraube | Anahtar<br>Allen Key<br>Innensechskantschlüssel | Montaj Vidası<br>Mounting Screw<br>Befestigungsschraube |             |
| AFM88C-SN1204-D050-A22-Z05                         | ●                      | 50  | 5   | 22   | 40 | 11   | SN.. 1204..                               | ACK-21                                      | AKV-24-M6x1x18                               | AAL-03-3  | 2408-M10x30   |             |
| AFM88C-SN1204-D063-A22-Z06                         | ●                      | 63  | 6   | 22   | 40 | 11   |   |   |  |   |   | 2510-M12x35 |
| AFM88C-SN1204-D080-A27-Z07                         | ●                      | 80  | 7   | 27   | 50 | 11   |   |   |  |   |   | 2514-M16x35 |
| AFM88C-SN1204-D100-A32-Z08                         | ●                      | 100   | 8   | 32   | 50 | 11   |   |   |  |   |   | -           |
| AFM88C-SN1204-D125-B40-Z11                         | ●                      | 125   | 11  | 40   | 63 | 11   |   |   |  |   |   | -           |

R: Sağ / Right / Rechts L: Sol / Left / Links

● Stokta / In Stock / Auf Lager ○ Stokta Yok / Non Stock Item / Kein Lagerartikel, Lieferzeit auf Anfrage

UNIN-NT-KYCR Ucuna Uygundur. / Compatible with UNIN-NT-KYCR Insert. / Kompatibel mit UNIN-NT-KYCR Wendepfatten.

Sipariş Örneği/Ordering Example/Bestellbeispiel  
1 ad./pcs./stück AFM75C-SP12-D050-A22-Z04



KAPR=90°

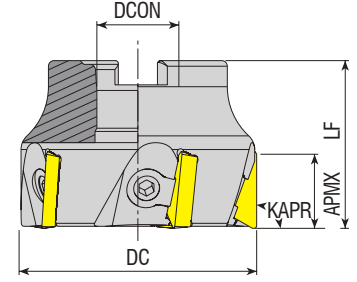

| Takım Kodu<br>Ordering Code<br>Bestell-Bezeichnung | Stok<br>Stock<br>Lager | Takım Ölçüleri (mm)<br>Dimension (mm)<br>Abmessung (mm) |      |      |    |      | Kesici Uç<br>Insert<br>Wendeschneidplatte | Yedek Parçaları / Spare Parts / Ersatzteile |  |   |   |
|--|------------------------|---|------|------|----|------|---|---|--|---|---|
|  |                        | DC  | ZEFP | DCON | LF | APMX |   | Baskı Parçası<br>Wedge Clamp<br>Spannpratze | Baskı Vidası<br>Clamp Screw<br>Klemmschraube | Anahtar<br>Allen Key<br>Innensechskantschlüssel | Montaj Vidası<br>Mounting Screw<br>Befestigungsschraube |
| AFM90C-TP16-D050-A22-Z04                           | ●                      | 50  | 4    | 22   | 40 | 12   | TP. 1603..                                | ACK-10                                      | AKV-22-M8x1x14<br>AKV-13-M8x1x16             | AAL-05-4  | 2407-M10x30   |
| AFM90C-TP16-D063-A22-Z06                           | ●                      | 63  | 6    | 22   | 45 | 12   |   |   |  |   | 2508-M10x30   |
| AFM90C-TP16-D080-A27-Z07                           | ●                      | 80  | 7    | 27   | 50 | 12   |   |   |  |   | 2510-M12x35   |
| AFM90C-TP16-D100-A32-Z08                           | ●                      | 100   | 8    | 32   | 50 | 12   |   |   |  |   | 2514-M16x35   |
| AFM90C-TP16-D125-B40-Z08                           | ●                      | 125   | 8    | 40   | 63 | 12   |   |   |  |   | -   |
| AFM90C-TP22-D063-A22-Z05                           | ●                      | 63  | 5    | 22   | 45 | 18   | TP. 2204..                                | ACK-11                                      | AKV-14-M8x1x18                               | AAL-05-4  | 2508-M10x30   |
| AFM90C-TP22-D080-A27-Z06                           | ●                      | 80  | 6    | 27   | 50 | 18   |   |   |  |   | 2510-M12x35   |
| AFM90C-TP22-D100-A32-Z07                           | ●                      | 100   | 7    | 32   | 50 | 18   |   |   |  |   | 2514-M16x35   |
| AFM90C-TP22-D125-B40-Z08                           | ●                      | 125   | 8    | 40   | 63 | 18   |   |   |  |   | -   |
| AFM90C-TP22-D160-C40-Z09                           | ●                      | 160   | 9    | 40   | 63 | 18   |   |   |  |   |   |
| AFM90C-TP22-D200-C60-Z12                           | ●                      | 200   | 12   | 60   | 63 | 18   |   |   |  |   |   |
| AFM90C-TP22-D250-C60-Z15                           | ●                      | 250   | 15   | 60   | 63 | 18   |   |   |  |   |   |
| AFM90C-TP22-D315-D60-Z18                           | ●                      | 315   | 18   | 60   | 63 | 18   |   |   |  |   |   |

ISO Ucuna Uygun. / Compatible with ISO Insert. / Kompatibel mit ISO Wendepatten.

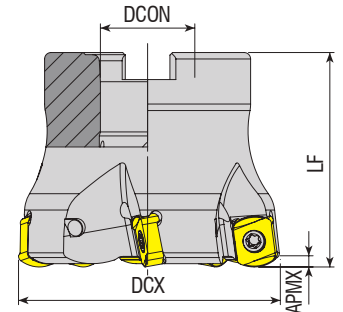

| Takım Kodu<br>Ordering Code<br>Bestell-Bezeichnung | Stok<br>Stock<br>Lager | Takım Ölçüleri (mm)<br>Dimension (mm)<br>Abmessung (mm) |      |      |    |      | Kesici Uç<br>Insert<br>Wendeschneidplatte | Yedek Parçaları / Spare Parts / Ersatzteile |  |   |  |  |  |
|--|------------------------|---|------|------|----|------|---|---|--|---|--|--|--|
|  |                        | DCX   | ZEFP | DCON | LF | APMX |   | Sıkma Vidası<br>Screw<br>Schraube           | Tork Anahtar<br>Torx Key<br>Torx-Schlüssel | Montaj Vidası<br>Mounting Screw<br>Befestigungsschraube |  |  |  |
| AHFM-BL0603-D040-A16-Z06-H                         | ●                      | 40  | 6    | 16   | 40 | 1    | BLMP 0603..                               | 3008-M2.5x6                                 | 82-T08                                     | 2506-M8x30  |  |  |  |
| AHFM-BL0603-D050-A22-Z07-H                         | ●                      | 50  | 7    | 22   | 40 | 1    |   |   |  |   |  |  |  |
| AHFM-BL0904-D040-A16-Z05-H                         | ●                      | 40  | 5    | 16   | 40 | 2    | BLMP 0904..                               | 3010-M3.5x9                                 | 82-T10                                     | 2508-M10x30   |  |  |  |
| AHFM-BL0904-D050-A22-Z06-H                         | ●                      | 50  | 6    | 22   | 50 | 2    |   |   |  |   |  |  |  |
| AHFM-BL0904-D063-A22-Z05-H                         | ●                      | 63  | 5    | 22   | 50 | 2    |   |   |  |   |  |  |  |
| AHFM-BL0904-D063-A22-Z07-H                         | ●                      | 63  | 7    | 22   | 50 | 2    |   |   |  |   |  |  |  |

R: Sağ / Right / Rechts L: Sol / Left / Links

● Stokta / In Stock / Auf Lager ○ Stokta Yok / Non Stock Item / Kein Lagerartikel, Lieferzeit auf Anfrage

TGTC Ucuna Uygun. / Compatible with TGTC Insert. / Kompatibel mit TGTC Wendepatten.

Sipariş Örneği/Ordering Example/Bestellbeispiel

1 ad./pcs./stück AFM90C-TP16-D050-A22-Z04

Kesme Hesabı : S 377 / Cutting Calculation : P 377 / Schnittberechnung : P 377

Montaj Ölçüleri : S 374 / Mounting Reference : P 374 / Montagehinweis : P 374

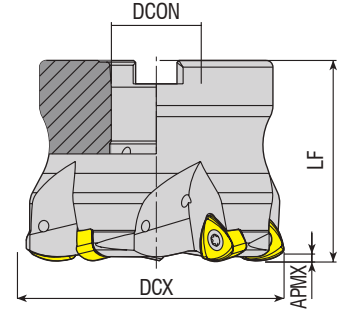

| Takım Kodu<br>Ordering Code<br>Bestell-Bezeichnung | Stok<br>Stock<br>Lager | Takım Ölçüleri (mm)<br>Dimension (mm)<br>Abmessung (mm) |      |      |    |      | Kesici Uç<br>Insert<br>Wendeschneidplatte | Yedek Parçaları / Spare Parts / Ersatzteile |  |   |
|--|------------------------|---|------|------|----|------|---|---|--|---|
|  |                        | DCX   | ZEFP | DCON | LF | APMX |   | Sıkma Vidası<br>Screw<br>Schraube           | Tork Anahtar<br>Torx Key<br>Torx-Schlüssel | Montaj Vidası<br>Mounting Screw<br>Befestigungsschraube |
| AHFM-BL1205-D050-A22-Z03-H                         | ●                      | 50  | 3    | 22   | 40 | 2    | BLMP 1205..                               | 4015-M4x11                                  | 80-T15                                     | 2508-M10x30<br>2510-M12x35                              |
| AHFM-BL1205-D063-A22-Z04-H                         | ●                      | 63  | 4    | 22   | 40 | 2    |   |   |  |   |
| AHFM-BL1205-D080-A27-Z05-H                         | ●                      | 80  | 5    | 27   | 50 | 2    |   |   |  |   |

TGTC Ucuna Uygunur. / Compatible with TGTC Insert. / Kompatibel mit TGTC Wendeplatten.

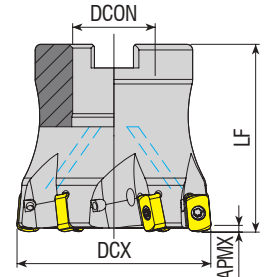

| Takım Kodu<br>Ordering Code<br>Bestell-Bezeichnung | Stok<br>Stock<br>Lager | Takım Ölçüleri (mm)<br>Dimension (mm)<br>Abmessung (mm) |      |      |    |      | Kesici Uç<br>Insert<br>Wendeschneidplatte | Yedek Parçaları / Spare Parts / Ersatzteile |  |   |
|--|------------------------|---|------|------|----|------|---|---|--|---|
|  |                        | DCX   | ZEFP | DCON | LF | APMX |   | Sıkma Vidası<br>Screw<br>Schraube           | Tork Anahtar<br>Torx Key<br>Torx-Schlüssel | Montaj Vidası<br>Mounting Screw<br>Befestigungsschraube |
| AHFM-EN1004-D050-A22-Z05-H                         | ●                      | 50  | 5    | 22   | 50 | 1    | ENMU 1004..                               | 3008-M2.5X6                                 | 82-T08                                     | 2508-M10x30   |
| AHFM-EN1004-D050-A22-Z06-H                         | ●                      | 50  | 6    | 22   | 50 | 1    |   |   |  |   |
| AHFM-EN1004-D052-A22-Z06-H                         | ●                      | 52  | 6    | 22   | 50 | 1    |   |   |  |   |
| AHFM-EN1004-D063-A22-Z06-H                         | ●                      | 63  | 6    | 22   | 50 | 1    |   |   |  |   |

R: Sağ / Right / Rechts L: Sol / Left / Links

● Stokta / In Stock / Auf Lager ○ Stokta Yok / Non Stock Item / Kein Lagerartikel, Lieferzeit auf Anfrage  
DJT Ucuna Uygunur. / Compatible with DJT Insert. / Kompatibel mit DJT Wendeplatten.

Sipariş Örneği/Ordering Example/Bestellbeispiel

1 ad./pcs./stück AHFM-BL1205-D050-A22-Z03-H

Kesme Hesabı : S 377 / Cutting Calculation : P 377 / Schnittberechnung : P 377

Montaj Ölçüleri : S 374 / Mounting Reference : P 374 / Montagehinweis : P 374



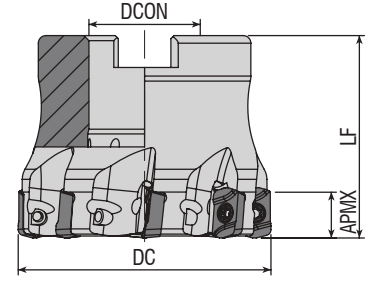

| Takım Kodu<br>Ordering Code<br>Bestell-Bezeichnung | Stok<br>Stock<br>Lager | Takım Ölçüleri (mm)<br>Dimension (mm)<br>Abmessung (mm) |      |      |    |      | Kesici Uç<br>Insert<br>Wendeschneidplatte | Yedek Parçaları / Spare Parts / Ersatzteile |  |   |
|--|------------------------|---|------|------|----|------|---|---|--|---|
|  |                        | DC  | ZEFP | DCON | LF | APMX |   | Sıkma Vidası<br>Screw<br>Schraube           | Tork Anahtar<br>Torx Key<br>Torx-Schlüssel | Montaj Vidası<br>Mounting Screw<br>Befestigungsschraube |
| AHFM-EP1003-D050-A22-Z08-H                         | ●                      | 50  | 8    | 22   | 40 | 1    |   |   |  |   |
| AHFM-EP1003-D063-A22-Z08-H                         | ●                      | 63  | 8    | 22   | 40 | 1    |   |   |  |   |

DJT Ucuna Uygundur. / Compatible with DJT Insert. / Kompatibel mit DJT Wendepfatten.

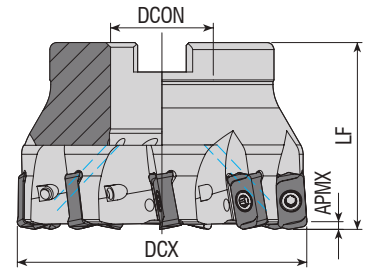

| Takım Kodu<br>Ordering Code<br>Bestell-Bezeichnung | Stok<br>Stock<br>Lager | Takım Ölçüleri (mm)<br>Dimension (mm)<br>Abmessung (mm) |      |      |    |      | Kesici Uç<br>Insert<br>Wendeschneidplatte | Yedek Parçaları / Spare Parts / Ersatzteile |  |   |
|--|------------------------|---|------|------|----|------|---|---|--|---|
|  |                        | DCX   | ZEFP | DCON | LF | APMX |   | Sıkma Vidası<br>Screw<br>Schraube           | Tork Anahtar<br>Torx Key<br>Torx-Schlüssel | Montaj Vidası<br>Mounting Screw<br>Befestigungsschraube |
| AHFM-L003-D040-A16-Z06-H                           | ●                      | 40  | 6    | 16   | 40 | 1    |   |   |  | 2506-M8x30  |
| AHFM-L003-D050-A22-Z07-H                           | ●                      | 50  | 7    | 22   | 40 | 1    |   |   |  | 2508-M10x30   |
| AHFM-L003-D063-A22-Z09-H                           | ●                      | 63  | 9    | 22   | 40 | 1    |   |   |  |   |

KYCR Ucuna Uygundur. / Compatible with KYCR Insert. / Kompatibel mit KYCR Wendepfatten.

Sipariş Örneği/Ordering Example/Bestellbeispiel

1 ad./pcs./stück AHFM-EP1003-D050-A22-Z08-H

Kesme Hesabı : S 377 / Cutting Calculation : P 377 / Schnittberechnung : P 377

Montaj Ölçüleri : S 374 / Mounting Reference : P 374 / Montagehinweis : P374

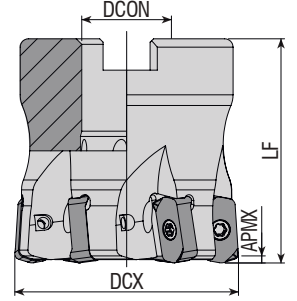

| Takım Kodu<br>Ordering Code<br>Bestell-Bezeichnung | Stok<br>Stock<br>Lager | Takım Ölçüleri (mm)<br>Dimension (mm)<br>Abmessung (mm) |      |      |    |      | Kesici Uç<br>Insert<br>Wendeschneidplatte | Yedek Parçaları / Spare Parts / Ersatzteile |  |   |        |             |
|--|------------------------|---|------|------|----|------|---|---|--|---|--------|-------------|
|  |                        | DCX   | ZEFP | DCON | LF | APMX |   | Sıkma Vidası<br>Screw<br>Schraube           | Tork Anahtar<br>Torx Key<br>Torx-Schlüssel | Montaj Vidası<br>Mounting Screw<br>Befestigungsschraube |        |             |
| AHFM-LN0303-D040-A16-Z06-H                         | ●                      | 40  | 6    | 16   | 40 | 12   | LNMU 0303..                               |   |  | 2506-M8x30  |        |             |
| AHFM-LN0303-D050-A22-Z07-H                         | ●                      | 50  | 7    | 22   | 50 | 12   |   |   |  | 3008-M2.5X6   | 82-T08 | 2508-M10x30 |
| AHFM-LN0303-D063-A22-Z09-H                         | ●                      | 63  | 9    | 22   | 50 | 12   |   |   |  |   |        |             |

TNGYL Ucuna Uygundur. / Compatible with TNGYL Insert. / Kompatibel mit TNGYL Wendeplatten.

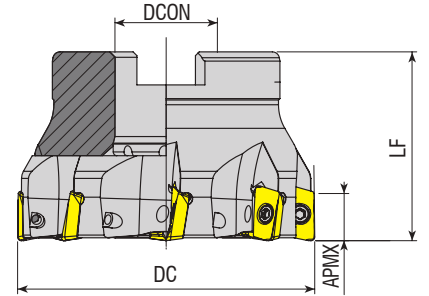

| Takım Kodu<br>Ordering Code<br>Bestell-Bezeichnung | Stok<br>Stock<br>Lager | Takım Ölçüleri (mm)<br>Dimension (mm)<br>Abmessung (mm) |      |      |    |      | Kesici Uç<br>Insert<br>Wendeschneidplatte | Yedek Parçaları / Spare Parts / Ersatzteile |  |   |
|--|------------------------|---|------|------|----|------|---|---|--|---|
|  |                        | DC  | ZEFP | DCON | LF | APMX |   | Sıkma Vidası<br>Screw<br>Schraube           | Tork Anahtar<br>Torx Key<br>Torx-Schlüssel | Montaj Vidası<br>Mounting Screw<br>Befestigungsschraube |
| AHFM-JD1003-D040-A16-Z06-H                         | ●                      | 40  | 6    | 16   | 40 | 9    | JDMT 1003..                               |   |  | 2506-M8x30  |
| AHFM-JD1003-D063-A22-Z08-H                         | ●                      | 63  | 8    | 22   | 40 | 9    |   |   |  | 3008-M2.5x6   |

HTCH Ucuna Uygundur. / Compatible with HTCH Insert. / Kompatibel mit HTCH Wendeplatten.

Sipariş Örneği/Ordering Example/Bestellbeispiel

1 ad./pcs./stück AHFM-LN0303-D040-A16-Z06-H

Kesme Hesabı : S 377 / Cutting Calculation : P 377 / Schnittberechnung : P 377

Montaj Ölçüleri : S 374 / Mounting Reference : P 374 / Montagehinweis : P374

new

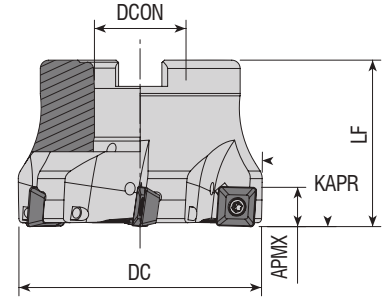

| Takım Kodu<br>Ordering Code<br>Bestell-Bezeichnung | Stok<br>Stock<br>Lager | Takım Ölçüleri (mm)<br>Dimension (mm)<br>Abmessung (mm) |      |      |    |      | Kesici Uç<br>Insert<br>Wendeschneidplatte | Yedek Parçaları / Spare Parts / Ersatzteile |  |   |
|--|------------------------|---|------|------|----|------|---|---|--|---|
|  |                        | DC  | ZEFP | DCON | LF | APMX |   | Sıkma Vidası<br>Screw<br>Schraube           | Tork Anahtar<br>Torx Key<br>Torx-Schlüssel | Montaj Vidası<br>Mounting Screw<br>Befestigungsschraube |
| AHFM-SP0945-D050-A22-Z06-H                         | ●                      | 50  | 6    | 22   | 40 | 1.4  |   |   |  |   |
| AHFM-SP0945-D052-A22-Z06-H                         | ●                      | 52  | 6    | 22   | 40 | 1.4  |   |   |  |   |

MTSBH Ucuna Uygunur. / Compatible with MTSBH Insert. / Kompatibel mit MTSBH Wendeplatten.

new

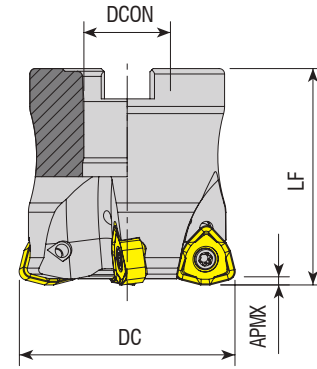

| Takım Kodu<br>Ordering Code<br>Bestell-Bezeichnung | Stok<br>Stock<br>Lager | Takım Ölçüleri (mm)<br>Dimension (mm)<br>Abmessung (mm) |      |      |    |      | Kesici Uç<br>Insert<br>Wendeschneidplatte | Yedek Parçaları / Spare Parts / Ersatzteile |  |   |
|--|------------------------|---|------|------|----|------|---|---|--|---|
|  |                        | DC  | ZEFP | DCON | LF | APMX |   | Sıkma Vidası<br>Screw<br>Schraube           | Tork Anahtar<br>Torx Key<br>Torx-Schlüssel | Montaj Vidası<br>Mounting Screw<br>Befestigungsschraube |
| AHFM-J009-D050-A22-Z04-H                           | ●                      | 50  | 4    | 22   | 50 | 1.2  |   |   |  |   |
| AHFM-J009-D063-A22-Z05-H                           | ●                      | 63  | 5    | 22   | 50 | 1.2  |   |   |  |   |

MTSBH Ucuna Uygunur. / Compatible with MTSBH Insert. / Kompatibel mit MTSBH Wendeplatten.

Sipariş Örneği/Ordering Example/Bestellbeispiel

1 ad./pcs./stück AHFM-SP0945-D050-A22-Z06-H

Kesme Hesabı : S 377 / Cutting Calculation : P 377 / Schnittberechnung : P 377

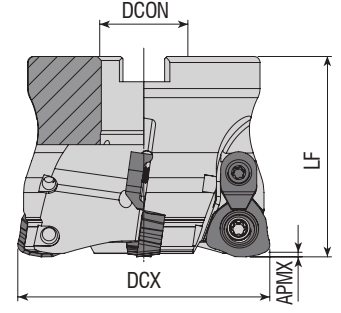

| Takım Kodu<br>Ordering Code<br>Bestell-Bezeichnung | Stok<br>Stock<br>Lager | Takım Ölçüleri (mm)<br>Dimension (mm)<br>Abmessung (mm) |      |      |    |      | Kesici Uç<br>Insert<br>Wendeschneidplatte | Yedek Parçaları / Spare Parts / Ersatzteile |  |  |  |   |
|--|------------------------|---|------|------|----|------|---|---|--|--|--|---|
|  |                        | DCX   | ZEFP | DCON | LF | APMX |   | Sıkma Vidası<br>Screw<br>Schraube           | Baskı Pabucu<br>Wedge Clamp<br>Spannpratze | Baskı Vidası<br>Clamp Screw<br>Klemmschraube | Tork Anahtar<br>Torx Key<br>Torx-Schlüssel | Montaj Vidası<br>Mounting Screw<br>Befestigungsschraube |
| AHFMC-JD1204-D052-A22-Z03-H                        | ●                      | 52  | 3    | 22   | 50 | 1.5  | JDMW 1204..                               | 4615-M4x11                                  | ACK-05                                     | 4015-M4x11                                   | 80-T15                                     | 2508-M10x30   |
| AHFMC-JD1204-D052-A22-Z04-H                        | ●                      | 52  | 4    | 22   | 50 | 1.5  |   |   |  |  |  |   |
| AHFMC-JD1204-D063-A22-Z05-H                        | ●                      | 63  | 5    | 22   | 50 | 1.5  |   |   |  |  |  |   |
| AHFMC-JD1204-D080-A27-Z06-H                        | ●                      | 80  | 6    | 27   | 50 | 1.5  |   |   |  |  |  |   |
| AHFMC-JD1204-D100-A32-Z07-H                        | ●                      | 100   | 7    | 32   | 50 | 1.5  |   |   |  |  |  |   |
| AHFMC-JD1405-D052-A22-Z03-H                        | ●                      | 52  | 3    | 22   | 40 | 2    | JDMW 1405..                               | 1020-M5x11                                  | 80-T20                                     | 2408-M10x30                                  |  |   |
| AHFMC-JD1405-D063-A22-Z04-H                        | ●                      | 63  | 4    | 22   | 40 | 2    |   |   |  |  | 2508-M10x30                                |   |

MTSBH Ucuna Uygun. / Compatible with MTSBH Insert. / Kompatibel mit MTSBH Wendepplatten.

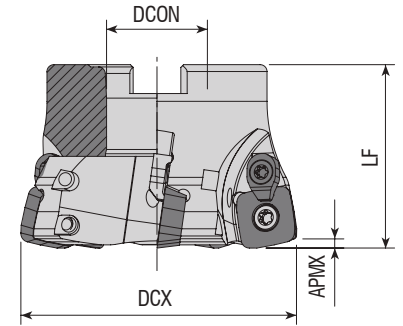

| Takım Kodu<br>Ordering Code<br>Bestell-Bezeichnung | Stok<br>Stock<br>Lager | Takım Ölçüleri (mm)<br>Dimension (mm)<br>Abmessung (mm) |      |      |    |      | Kesici Uç<br>Insert<br>Wendeschneidplatte | Yedek Parçaları / Spare Parts / Ersatzteile |  |  |  |   |
|--|------------------------|---|------|------|----|------|---|---|--|--|--|---|
|  |                        | DCX   | ZEFP | DCON | LF | APMX |   | Sıkma Vidası<br>Screw<br>Schraube           | Baskı Pabucu<br>Wedge Clamp<br>Spannpratze | Baskı Vidası<br>Clamp Screw<br>Klemmschraube | Tork Anahtar<br>Torx Key<br>Torx-Schlüssel | Montaj Vidası<br>Mounting Screw<br>Befestigungsschraube |
| AHFMC-SD1204-D050-A22-Z04-H                        | ●                      | 50  | 4    | 22   | 40 | 1.8  | SD.. 1204..                               | 4015-M4x11                                  | ACK-15                                     | 4015-M3.5x11                                 | 80-T15                                     | 2508-M10x30   |
| AHFMC-SD1204-D063-A22-Z05-H                        | ●                      | 63  | 5    | 22   | 40 | 1.8  |   |   |  |  |  |   |
| AHFMC-SD1204-D080-A27-Z06-H                        | ●                      | 80  | 6    | 27   | 50 | 1.8  |   |   |  |  |  |   |
| AHFMC-SD1204-D100-A32-Z08-H                        | ●                      | 100   | 8    | 32   | 50 | 1.8  |   |   |  |  |  |   |

ZGC Ucuna Uygun. / Compatible with ZGC Insert. / Kompatibel mit ZGC Wendepplatten.





Sipariş Örneği/Ordering Example/Bestellbeispiel

1 ad./pcs./stück AHFMC-JD1204-D052-A22-Z03-H

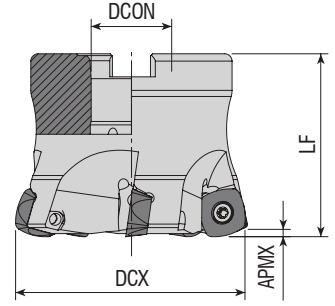
Kesme Hesabı : S 377 / Cutting Calculation : P 377 / Schnittberechnung : P 377





Montaj Ölçüleri : S 374 / Mounting Reference : P 374 / Montagehinweis : P374

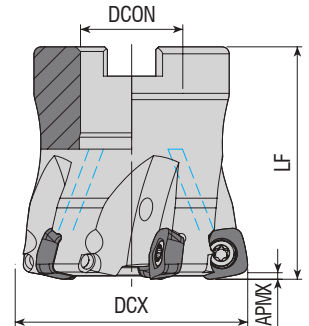

| Takım Kodu<br>Ordering Code<br>Bestell-Bezeichnung | Stok<br>Stock<br>Lager | Takım Ölçüleri (mm)<br>Dimension (mm)<br>Abmessung (mm) |      |      |    |      | Kesici Uç<br>Insert<br>Wendeschneidplatte   | Yedek Parçaları / Spare Parts / Ersatzteile  |   |   |
|--|------------------------|---|------|------|----|------|---|--|---|---|
|  |                        | DCX   | ZEFP | DCON | LF | APMX |   | Sıkma Vidası<br>Screw<br>Schraube  | Tork Anahtar<br>Torx Key<br>Torx-Schlüssel  | Montaj Vidası<br>Mounting Screw<br>Befestigungsschraube                             |
| AHFM-SD1205-D052-A22-Z04-H                         | ●                      | 52  | 4    | 22   | 50 | 2    |  |  |  |  |
| AHFM-SD1205-D052-A22-Z05-H                         | ●                      | 52  | 5    | 22   | 50 | 2    |   |  |   |   |
| <b>new</b> AHFM-SD1205-D063-A22-Z05-H              | ●                      | 63  | 5    | 22   | 50 | 2    |   |  |   |   |
| AHFM-SD1205-D066-A22-Z05-H                         | ●                      | 66  | 5    | 22   | 50 | 2    |   |  |   |   |
| AHFM-SD1205-D066-A22-Z06-H                         | ●                      | 66  | 6    | 22   | 50 | 2    |   |  |   |   |
| AHFM-SD1205-D080-A27-Z06-H                         | ●                      | 80  | 6    | 27   | 70 | 2    |   |  |   |   |
|  |                        |   |      |      |    |      |   |  |   |   |

HTCH Ucuna Uygunur. / Compatible with HTCH Insert. / Kompatibel mit HTCH Wendeplatten.

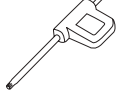

| Takım Kodu<br>Ordering Code<br>Bestell-Bezeichnung | Stok<br>Stock<br>Lager | Takım Ölçüleri (mm)<br>Dimension (mm)<br>Abmessung (mm) |      |      |    |      | Kesici Uç<br>Insert<br>Wendeschneidplatte   | Yedek Parçaları / Spare Parts / Ersatzteile  |   |   |
|--|------------------------|---|------|------|----|------|---|--|---|---|
|  |                        | DCX   | ZEFP | DCON | LF | APMX |   | Sıkma Vidası<br>Screw<br>Schraube  | Tork Anahtar<br>Torx Key<br>Torx-Schlüssel  | Montaj Vidası<br>Mounting Screw<br>Befestigungsschraube                               |
| AHFM-SO1004-D050-A22-Z05-H                         | ●                      | 50  | 5    | 22   | 50 | 1.5  |  |  |  |  |
| AHFM-SO1004-D063-A22-Z06-H                         | ●                      | 63  | 6    | 22   | 50 | 1.5  |   |  |   |   |
| AHFM-SO1004-D080-A27-Z07-H                         | ●                      | 80  | 7    | 27   | 63 | 1.5  |   |  |   |   |
|  |                        |   |      |      |    |      |   |  |   |  |

KYCR Ucuna Uygunur. / Compatible with KYCR Insert. / Kompatibel mit KYCR Wendeplatten.

Sipariş Örneği/Ordering Example/Bestellbeispiel

1 ad./pcs./stück AHFM-SD1205-D052-A22-Z04-H

Kesme Hesabı : S 377 / Cutting Calculation : P 377 / Schnittberechnung : P 377

Montaj Ölçüleri : S 374 / Mounting Reference : P 374 / Montagehinweis : P374

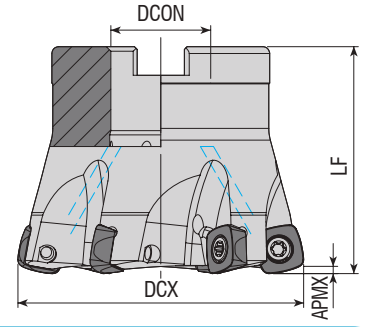

| Takım Kodu<br>Ordering Code<br>Bestell-Bezeichnung | Stok<br>Stock<br>Lager | Takım Ölçüleri (mm)<br>Dimension (mm)<br>Abmessung (mm) |      |      |    |      | Kesici Uç<br>Insert<br>Wendeschneidplatte | Yedek Parçaları / Spare Parts / Ersatzteile |  |   |  |
|--|------------------------|---|------|------|----|------|---|---|--|---|--|
|  |                        | DCX   | ZEPF | DCON | LF | APMX |   | Sıkma Vidası<br>Screw<br>Schraube           | Tork Anahtar<br>Torx Key<br>Torx-Schlüssel | Montaj Vidası<br>Mounting Screw<br>Befestigungsschraube |  |
| AHFM-SP1004-D050-A22-Z05-H                         | ●                      | 50  | 5    | 22   | 50 | 1.5  | SPNW 1004..                               |   |  |   |  |
| AHFM-SP1004-D052-A22-Z05-H                         | ●                      | 52  | 5    | 22   | 50 | 1.5  |   |   |  |   |  |
| AHFM-SP1004-D063-A22-Z06-H                         | ●                      | 63  | 6    | 22   | 50 | 1.5  |   |   |  |   |  |

DJT Ucuna Uygun. / Compatible with DJT Insert. / Kompatibel mit DJT Wendeplatten.

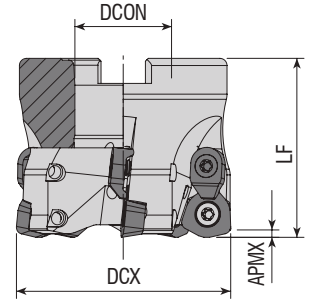

| Takım Kodu<br>Ordering Code<br>Bestell-Bezeichnung | Stok<br>Stock<br>Lager | Takım Ölçüleri (mm)<br>Dimension (mm)<br>Abmessung (mm) |      |      |    |      | Kesici Uç<br>Insert<br>Wendeschneidplatte | Yedek Parçaları / Spare Parts / Ersatzteile |  |  |  |   |             |  |  |  |  |  |
|--|------------------------|---|------|------|----|------|---|---|--|--|--|---|-------------|--|--|--|--|--|
|  |                        | DCX   | ZEPF | DCON | LF | APMX |   | Sıkma Vidası<br>Screw<br>Schraube           | Baskı Pabucu<br>Wedge Clamp<br>Spannpratze | Baskı Vidası<br>Clamp Screw<br>Klemmschraube | Tork Anahtar<br>Torx Key<br>Torx-Schlüssel | Montaj Vidası<br>Mounting Screw<br>Befestigungsschraube |             |  |  |  |  |  |
| AHFMC-WD06T3D-D042-A16-Z04-H                       | ●                      | 42  | 4    | 16   | 45 | 1.5  | WD.W 06T3..                               |   |  |  |  |   |             |  |  |  |  |  |
| AHFMC-WD06T3D-D050-A22-Z05-H                       | ●                      | 50  | 5    | 22   | 50 | 1.5  |   |   |  |  |  |   |             |  |  |  |  |  |
| AHFMC-WD06T3D-D052-A22-Z05-H                       | ●                      | 52  | 5    | 22   | 50 | 1.5  |   |   |  |  |  |   |             |  |  |  |  |  |
| AHFMC-WD06T3D-D063-A22-Z06-H                       | ●                      | 63  | 6    | 22   | 50 | 1.5  | WD.W 0805..                               |   |  |  |  |   |             |  |  |  |  |  |
| AHFMC-WD0805D-D052-A22-Z04-H                       | ●                      | 52  | 4    | 22   | 50 | 2    |   |   |  |  |  |   |             |  |  |  |  |  |
| AHFMC-WD0805D-D063-A22-Z05-H                       | ●                      | 63  | 5    | 22   | 50 | 2    |   |   |  |  |  |   |             |  |  |  |  |  |
| AHFMC-WD0805D-D063-A27-Z05-H                       | ●                      | 63  | 5    | 27   | 50 | 2    |   |   |  |  |  |   |             |  |  |  |  |  |
| AHFMC-WD0805D-D066-A27-Z05-H                       | ●                      | 66  | 5    | 27   | 50 | 2    |   |   |  |  |  |   |             |  |  |  |  |  |
| AHFMC-WD0805D-D080-A27-Z05                         | ●                      | 80  | 5    | 27   | 50 | 2    |   |   |  |  |  |   |             |  |  |  |  |  |
| AHFMC-WD0805D-D100-A32-Z06                         | ●                      | 100   | 6    | 32   | 50 | 2    |   |   |  |  |  |   |             |  |  |  |  |  |
| AHFMC-WD10X6D-D125-B40-Z06                         | ●                      | 125   | 6    | 40   | 63 | 2.5  |   |   |  |  |  |   | WD.W 10X6.. |  |  |  |  |  |
| AHFMC-WD10X6D-D160-C40-Z07                         | ●                      | 160   | 7    | 40   | 63 | 2.5  |   |   |  |  |  |   |             |  |  |  |  |  |

DJT Ucuna Uygun. / Compatible with DJT Insert. / Kompatibel mit DJT Wendeplatten.

Sipariş Örneği/Ordering Example/Bestellbeispiel

1 ad./pcs./stück AHFM-SP1004-D050-A22-Z05-H

Kesme Hesabı : S 377 / Cutting Calculation : P 377 / Schnittberechnung : P 377

Montaj Ölçüleri : S 374 / Mounting Reference : P 374 / Montagehinweis : P374

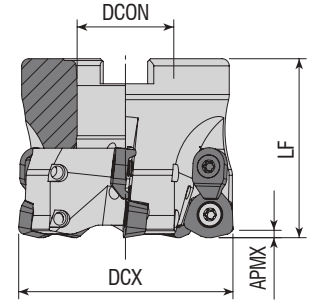

| Takım Kodu<br>Ordering Code<br>Bestell-Bezeichnung | Stok<br>Stock<br>Lager | Takım Ölçüleri (mm)<br>Dimension (mm)<br>Abmessung (mm) |      |      |    |      | Kesici Uç<br>Insert<br>Wendeschneidplatte | Yedek Parçaları / Spare Parts / Ersatzteile |  |  |  |   |
|--|------------------------|---|------|------|----|------|---|---|--|--|--|---|
|  |                        | DCX   | ZEFP | DCON | LF | APMX |   | Sıkma Vidası<br>Screw<br>Schraube           | Baskı Pabucu<br>Wedge Clamp<br>Spannpratze | Baskı Vidası<br>Clamp Screw<br>Klemmschraube | Tork Anahtar<br>Torx Key<br>Torx-Schlüssel | Montaj Vidası<br>Mounting Screw<br>Befestigungsschraube |
| AHFMC-WD0804-D040-A16-Z04-H                        | ●                      | 40  | 4    | 16   | 40 | 1.5  | WDMT 0804..                               | 4010-M3x8                                   | ACK-15                                     | 4010-M3x8                                    | 82-T10                                     | 2506-M8x30  |
| AHFMC-WD0804-D050-A22-Z04-H                        | ●                      | 50  | 4    | 22   | 50 | 1.5  |   |   |  |  |  |   |
| AHFMC-WD1205-D050-A22-Z04-H                        | ●                      | 50  | 4    | 22   | 50 | 3    | WDMT 1205..                               | 1415-M4x11                                  | ACK-05                                     | 4015-M4x11                                   | 80-T15                                     | 2508-M10x30   |
| AHFMC-WD1205-D052-A22-Z04-H                        | ●                      | 52  | 4    | 22   | 50 | 3    |   |   |  |  |  |   |
| AHFMC-WD1205-D063-A22-Z05-H                        | ●                      | 63  | 5    | 22   | 50 | 3    |   |   |  |  |  |   |
| AHFMC-WD1205-D080-A27-Z06-H                        | ●                      | 80  | 6    | 27   | 63 | 3    |   |   |  |  |  |   |

SMTM Ucuna Uygun. / Compatible with SMTM Insert. / Kompatibel mit SMTM Wendeplatten.

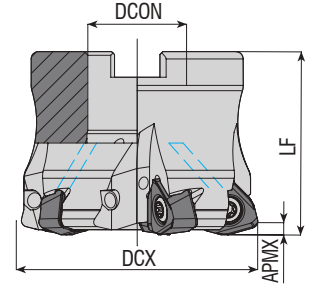

| Takım Kodu<br>Ordering Code<br>Bestell-Bezeichnung | Stok<br>Stock<br>Lager | Takım Ölçüleri (mm)<br>Dimension (mm)<br>Abmessung (mm) |      |      |    |      | Kesici Uç<br>Insert<br>Wendeschneidplatte | Yedek Parçaları / Spare Parts / Ersatzteile |  |   |  |
|--|------------------------|---|------|------|----|------|---|---|--|---|--|
|  |                        | DCX   | ZEFP | DCON | LF | APMX |   | Sıkma Vidası<br>Screw<br>Schraube           | Tork Anahtar<br>Torx Key<br>Torx-Schlüssel | Montaj Vidası<br>Mounting Screw<br>Befestigungsschraube |  |
| AHFM-WN0706-D050-A22-Z05-H                         | ●                      | 50  | 5    | 22   | 50 | 2    | WNMU 0706..                               | 4015-M4x11                                  | 80-T15                                     | 2508-M10x30   |  |
| AHFM-WN0706-D063-A22-Z06-H                         | ●                      | 63  | 6    | 22   | 50 | 2    |   |   |  |   |  |
| AHFM-WN0907-D050-A22-Z04-H                         | ●                      | 50  | 4    | 22   | 50 | 3    | WNMU 0907..                               | 1020-M5x14                                  | 80-T20                                     | 2510-M12x35   |  |
| AHFM-WN0907-D052-A22-Z04-H                         | ●                      | 52  | 4    | 22   | 50 | 3    |   |   |  |   |  |
| AHFM-WN0907-D063-A22-Z05-H                         | ●                      | 63  | 5    | 22   | 50 | 3    |   |   |  |   |  |
| AHFM-WN0907-D066-A27-Z05-H                         | ●                      | 66  | 5    | 27   | 50 | 3    |   |   |  |   |  |
| AHFM-WN0907-D080-A27-Z06-H                         | ●                      | 80  | 6    | 27   | 50 | 3    |   |   |  |   |  |
| AHFM-WN0907-D100-A32-Z07-H                         | ●                      | 100   | 7    | 32   | 50 | 3    |   |   |  |   |  |

DJT Ucuna Uygun. / Compatible with DJT Insert. / Kompatibel mit DJT Wendeplatten.

Sipariş Örneği/Ordering Example/ Bestellbeispiel  
1 ad./pcs./stück AHFMC-WD0804-D040-A16-Z04-H  
Kesme Hesabı : S 377 / Cutting Calculation : P 377 / Schnittberechnung : P 377  
Montaj Ölçüleri : S 374 / Mounting Reference : P 374 / Montagehinweis : P 374

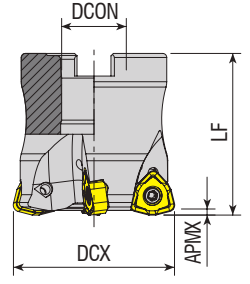

| Takım Kodu<br>Ordering Code<br>Bestell-Bezeichnung | Stok<br>Stock<br>Lager | Takım Ölçüleri (mm)<br>Dimension (mm)<br>Abmessung (mm) |      |      |    |      | Kesici Uç<br>Insert<br>Wendeschneidplatte | Yedek Parçaları / Spare Parts / Ersatzteile |  |   |
|--|------------------------|---|------|------|----|------|---|---|--|---|
|  |                        | DCX   | ZEPF | DCON | LF | APMX |   | Sıkma Vidası<br>Screw<br>Schraube           | Tork Anahtar<br>Torx Key<br>Torx-Schlüssel | Montaj Vidası<br>Mounting Screw<br>Befestigungsschraube |
| AHFM-WN09T3-D040-A16-Z04-H                         | ●                      | 40  | 4    | 16   | 40 | 1.5  | WMMX 09T3..                               | 4010-M3x8                                   | 82-T10                                     | 2506-M8x30  |
| AHFML-WN09T3-D040-A16-Z04-H                        | ●                      | 40  | 4    | 16   | 40 | 1.5  |   |   |  |   |
| AHFM-WN09T3-D050-A22-Z05-H                         | ●                      | 50  | 5    | 22   | 40 | 1.5  |   |   |  | 2508-M10x30   |
| AHFML-WN09T3-D050-A22-Z05-H                        | ●                      | 50  | 5    | 22   | 40 | 1.5  |   |   |  |   |
| AHFM-WN09T3-D063-A22-Z06-H                         | ●                      | 63  | 6    | 22   | 40 | 1.5  |   |   |  |   |

R: Sağ / Right / Rechts L: Sol / Left / Links

● Stokta / In Stock / Auf Lager ○ Stokta Yok / Non Stock Item / Kein Lagerartikel, Lieferzeit auf Anfrage  
KRLY Ucuna Uygunur. / Compatible with KRLY Insert. / Kompatibel mit KRLY Wendeplatten.

Sipariş Örneği/Ordering Example/Bestellbeispiel

1 ad./pcs./stück AHFM-WN09T3-D040-A16-Z04-H

Kesme Hesabı : S 377 / Cutting Calculation : P 377 / Schnittberechnung : P 377

Montaj Ölçüleri : S 374 / Mounting Reference : P 374 / Montagehinweis : P374





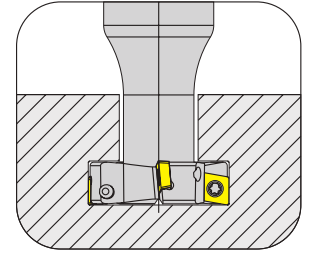
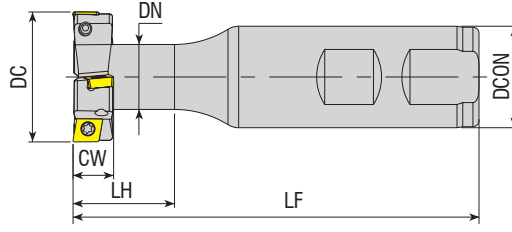

Takım Kodu  
Ordering Code  
Bestell-Bezeichnung

Stok  
Stock  
Lager

ZEFP  
Toplam  
Total  
Gesamt

Etkili  
Effective  
Effektiv

DC

CW

DCON

LF

DN

LH

Takım Ölçüleri (mm)  
Dimension (mm)  
Abmessung (mm)

Kesici Uç  
Insert  
Wendeschneidplatte

Yedek Parçaları / Spare Parts / Ersatzteile

Sıkma Vidası  
Screw  
Schraube

Tork Anahtar  
Torx Key  
Torx-Schlüssel



|                                   |   |   |   |      |    |    |     |      |      |             |             |        |
|-----------------------------------|---|---|---|------|----|----|-----|------|------|-------------|-------------|--------|
| ATSM90-CC06-D17X8-W16-L85-Z02     | ● | 2 | 1 | 17   | 8  | 16 | 85  | 10   | 16   | CC.T 0602.. | 3008-M2.5x6 | 82-T08 |
| ATSM90-CC06-D22X8-W20-L83-Z04     | ● | 4 | 2 | 22   | 8  | 20 | 83  | 9    | 38   |             |             |        |
| ATSM90-CC06-D32X8-W25-L100-Z04    | ● | 4 | 2 | 32   | 8  | 25 | 100 | 16   | 23   |             |             |        |
| ATSM90-CC06-D28X8-W20-L66-Z04     | ● | 4 | 2 | 28   | 8  | 20 | 66  | 14   | 15.5 |             |             |        |
| ATSM90-CC06-D45.5X8-W25-L100-Z06  | ● | 6 | 3 | 45.5 | 8  | 25 | 100 | 12   | 30   |             |             |        |
| ATSM90-CC06-D63X8-W32-L125-Z08    | ● | 8 | 4 | 63   | 8  | 32 | 125 | 31.5 | 30   |             |             |        |
| ATSM90-CC06-D18X9-W16-L90-Z02     | ● | 2 | 1 | 18   | 9  | 16 | 90  | 10   | 16   |             |             |        |
| ATSM90-CC06-D20X9-W16-L85-Z04     | ● | 4 | 2 | 20   | 9  | 16 | 85  | 10   | 16   |             |             |        |
| ATSM90-CC06-D23X10-W20-L90-Z04    | ● | 4 | 2 | 23   | 10 | 20 | 90  | 12   | 25   |             |             |        |
| ATSM90-CC06-D32X10-W25-L100-Z04   | ● | 4 | 2 | 32   | 10 | 25 | 100 | 16   | 25   |             |             |        |
| ATSM90-CC06-D45X10-W32-L120-Z06   | ● | 6 | 3 | 45   | 10 | 32 | 120 | 20   | 25   |             |             |        |
| ATSM90-CC06-D25X11-W25-L100-Z04   | ● | 4 | 2 | 25   | 11 | 25 | 100 | 13   | 20   |             |             |        |
| ATSM90-CC09-D30X12-W25-L100-Z04   | ● | 4 | 2 | 30   | 12 | 25 | 100 | 16   | 25   |             |             |        |
| ATSM90-CC09-D32X12-W25-L100-Z02   | ● | 2 | 1 | 32   | 12 | 25 | 100 | 16   | 25   |             |             |        |
| ATSM90-CC09-D32X12-W25-L100-Z04   | ● | 4 | 2 | 32   | 12 | 25 | 100 | 16   | 25   |             |             |        |
| ATSM90-CC09-D32X14-W25-L100-Z04   | ● | 4 | 2 | 32   | 14 | 25 | 100 | 16   | 25   |             |             |        |
| ATSM90-CC09-D37X16-W32-L120-Z04   | ● | 4 | 2 | 37   | 16 | 32 | 120 | 17   | 30   |             |             |        |
| ATSM90-CC09-D40X17-W32-L120-Z04-H | ● | 4 | 2 | 40   | 17 | 32 | 120 | 19   | 30   |             |             |        |
| ATSM90-CC09-D42X17-W32-L120-Z04   | ● | 4 | 2 | 42   | 17 | 32 | 120 | 19   | 30   |             |             |        |
| ATSM90-CC12-D47X20-W32-L120-Z04   | ● | 4 | 2 | 47   | 20 | 32 | 120 | 25   | 45   |             |             |        |
| ATSM90-CC12-D52X21-W32-L120-Z04   | ● | 4 | 2 | 52   | 21 | 32 | 120 | 25   | 45   |             |             |        |
| ATSM90-CC12-D50X22-W32-L120-Z04   | ● | 4 | 2 | 50   | 22 | 32 | 120 | 25   | 45   |             |             |        |
| ATSM90-CC12-D55X22-W32-L120-Z04   | ● | 4 | 2 | 55   | 22 | 32 | 120 | 25   | 45   |             |             |        |

R: Sağ / Right / Rechts L: Sol / Left / Links

● Stokta / In Stock / Auf Lager ○ Stokta Yok / Non Stock Item / Kein Lagerartikel, Lieferzeit auf Anfrage

Sipariş Örneği/Ordering Example/Bestellbeispiel

1 ad./pcs./stück ATSM90-CC06-D17X8-W16-L85-Z02

Kesme Hesabı : S 367 / Cutting Calculation : P 367 / Schnittberechnung : P 367



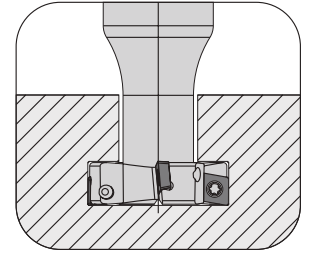
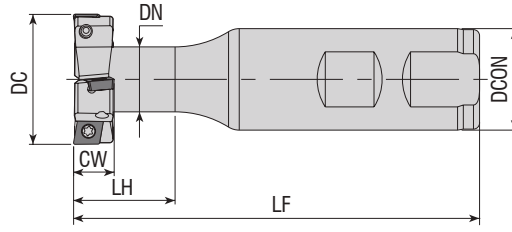

**Takım Kodu**  
**Ordering Code**  
Bestell-Bezeichnung

Stok  
Stock  
Lager

ZEPF  
Toplam  
Total  
Gesamt

Etkili  
Effective  
Effektiv

DC CW DCON LF DN LH

Takım Ölçüleri (mm)  
Dimension (mm)  
Abmessung (mm)

Kesici Uç  
Insert  
Wendeschneidplatte

Yedek Parçaları / Spare Parts / Ersatzteile

Sıkma Vidası  
Screw  
Schraube

Tork Anahtar  
Torx Key  
Torx-Schlüssel



|                                       |   |    |   |      |    |    |     |      |    |   |             |        |               |        |
|---------------------------------------|---|----|---|------|----|----|-----|------|----|---|-------------|--------|---------------|--------|
| ATSM90-SP.05-D22.5X5-W25-L100-Z04     | ● | 4  | 2 | 22.5 | 5  | 25 | 100 | 12   | 25 | SPMG 050204<br>TGTC UCUNA UYGUNDUR.<br>FOR TGTC INSERT. Kompatibel mit TGTC Wendepfatten    | 3006-M2x4   | 82-T06 |               |        |
| ATSM90-SP.05-D25X5-W25-L100-Z04       | ○ | 4  | 2 | 25   | 5  | 25 | 100 | 9    | 25 |   |             |        |               |        |
| ATSM90-SP.05-D30X5-W25-L100-Z04       | ● | 4  | 2 | 30   | 5  | 25 | 100 | 10   | 25 |   |             |        |               |        |
| ATSM90-SPGT0502-D63X6-W32-L125-Z10    | ● | 10 | 5 | 63   | 6  | 32 | 125 | 31   | 30 | SPGT 050204   | 4015-M3.5x9 | 80-T15 |               |        |
| ATSM90-SPGT0904-D32X14-W32-L120-Z04-H | ● | 4  | 2 | 32   | 14 | 32 | 120 | 17.5 | 30 | SPGT 090408<br>ZCC UCUNA UYGUNDUR.<br>FOR ZCC INSERT.<br>Kompatibel mit ZCC Wendepfatten    |             |        |               |        |
| ATSM90-SPGT0904-D37X16-W32-L120-Z04-H | ● | 4  | 2 | 37   | 16 | 32 | 120 | 21   | 40 |   |             |        |               |        |
| ATSM90-SPGT0904-D42X17-W32-L120-Z04-H | ● | 4  | 2 | 42   | 17 | 32 | 120 | 21   | 40 |   |             |        |               |        |
| ATSM90-SPGT1104-D47X20-W32-L120-Z04-H | ● | 4  | 2 | 47   | 20 | 32 | 120 | 24   | 45 | SPGT 110408   |             |        |               |        |
| ATSM90-SP.06-D80X7-W32-L120-Z10       | ● | 10 | 5 | 80   | 7  | 32 | 120 | 32   | 30 | SPMG 060204<br>TGTC UCUNA UYGUNDUR.<br>FOR TGTC INSERT.<br>Kompatibel mit TGTC Wendepfatten |             |        | 3007-M2.2x4.6 | 82-T07 |

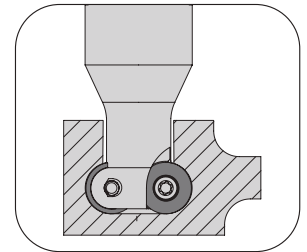
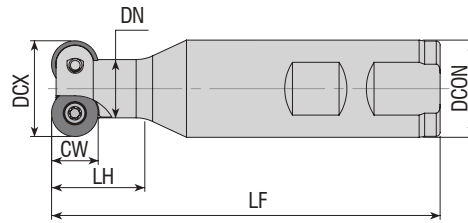

**Takım Kodu**  
**Ordering Code**  
Bestell-Bezeichnung

Stok  
Stock  
Lager

ZEPF

DCX

CW

DCON

LF

DN

LH

Takım Ölçüleri (mm)  
Dimension (mm)  
Abmessung (mm)

Kesici Uç  
Insert  
Wendeschneidplatte

Yedek Parçaları / Spare Parts / Ersatzteile

Sıkma Vidası  
Screw  
Schraube

Tork Anahtar  
Torx Key  
Torx-Schlüssel



|                                 |   |   |    |    |    |     |    |      |           |              |        |
|---------------------------------|---|---|----|----|----|-----|----|------|-----------|--------------|--------|
| ATSMR-RD0702-D17-W16-L90-Z02    | ● | 2 | 17 | 7  | 16 | 90  | 10 | 12   | RD.. 0702 | 3008-M2.5x6  | 82-T08 |
| ATSMR-RD0702-D25-W16-L90-Z03    | ● | 3 | 25 | 7  | 16 | 90  | 15 | 12   |           |              |        |
| ATSMR-RD0702-D35-W25-L100-Z05   | ● | 5 | 35 | 7  | 25 | 100 | 20 | 20   |           |              |        |
| ATSMR-RD1003-D21-W25-L100-Z02   | ● | 2 | 21 | 10 | 25 | 100 | 12 | 20   | RD.. 1003 | 4015-M3.5x9  | 80-T15 |
| ATSMR-RD1003-D80-W32-L165-Z06-H | ● | 6 | 80 | 10 | 32 | 165 | 30 | 31.5 |           |              |        |
| ATSMR-RD12T3-D25-W25-L100-Z02   | ● | 2 | 25 | 12 | 25 | 100 | 15 | 24   | RD.. 12T3 |              |        |
| ATSMR-RD12T3-D80-W32-L165-Z06-H | ● | 6 | 80 | 12 | 32 | 165 | 30 | 31.5 |           |              |        |
| ATSMR-RD1604-D34-W32-L110-Z02   | ● | 2 | 34 | 16 | 32 | 110 | 20 | 30   | RD.. 1604 | 4015-M4.5x11 |        |

R: Sağ / Right / Rechts L: Sol / Left / Links

● Stokta / In Stock / Auf Lager ○ Stokta Yok / Non Stock Item / Kein Lagerartikel, Lieferzeit auf Anfrage  
ISO Ucuna Uygun. / Compatible with ISO Insert. / Kompatibel mit ISO Wendepfatten.

Sipariş Örneği/Ordering Example/Bestellbeispiel

1 ad./pcs./stück ATSM90-SP.05-D22.5X5-W25-L100-Z04

Kesme Hesabı : S 367 / Cutting Calculation : P 367 / Schnittberechnung : P 367

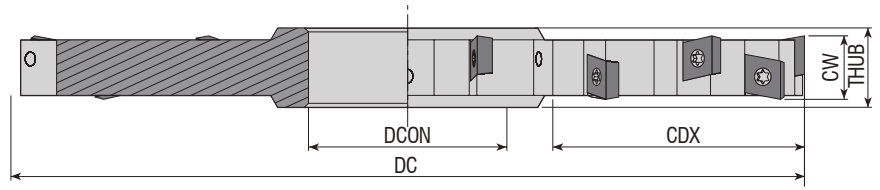
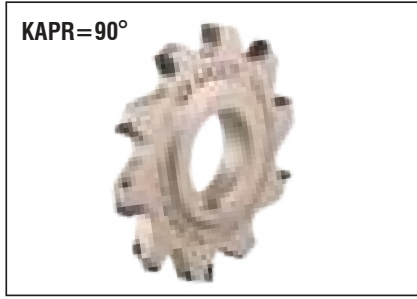

**Takım Kodu**  
**Ordering Code**  
*Bestell-Bezeichnung*

Stok  
Stock  
Lager

ZEPF

Toplam  
Total  
Gesamt

Etkili  
Effective  
Effektiv

DC

CW

CDX

DCON

THUB

Takım Ölçüleri (mm)  
Dimension (mm)  
Abmessung (mm)



Yedek Parçaları / Spare Parts / Ersatzteile

Sıkma Vidası  
Screw  
Schraube

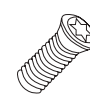

Tork Anahtar  
Torx Key  
Torx-Schlüssel



ASDM-SPGT05-D80x6-d27-Z10



10

5

80

6

17

27

10

**SPGT 050204**

ZCC UCUNA  
UYGUNDUR.  
FOR ZCC INSERT.  
Kompatibel mit ZCC Wendepfatten

3006-M2x4

82-T06

ASDM-SPGT05-D100x6-d32-Z12



12

6

100

6

25

32

10

ASDM-SPGT05-D125x6-d40-Z14



14

7

125

6

35

40

10

ASDM-SPGT05-D160x6-d40-Z18



18

9

160

6

52

40

10

ASDM-SPGT06-D80x7-d27-Z10



10

5

80

7

17

27

11

ASDM-SPGT06-D100x7-d32-Z12



12

6

100

7

25

32

11

ASDM-SPGT06-D125x7-d40-Z14



14

7

125

7

35

40

11

ASDM-SPGT06-D160x7-d40-Z16



16

8

160

7

52

40

11

ASDM-SPGT06-D200x7-d40-Z18



18

9

200

7

70

40

11

new

ASDM-SPGT07-D100x10-d27-Z10



10

5

100

10

26.5

27

14

**SPGT 07T308**

3008-M2.5x6

82-T08

ASDM-SPGT07-D100x10-d32-Z12



12

6

100

10

25

32

11

R: Sağ / Right / Rechts L: Sol / Left / Links

● Stokta / In Stock / Auf Lager ○ Stokta Yok / Non Stock Item / Kein Lagerartikel, Lieferzeit auf Anfrage

Sipariş Örneği/Ordering Example/Bestellbeispiel

1 ad./pcs./stück ASDM-SPGT05-D80x6-d27-Z10

Kesme Hesabı : S 367 / Cutting Calculation : P 367 / Schnittberechnung : P 367



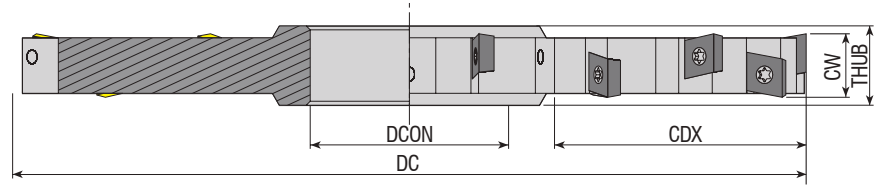

**Takım Kodu**  
**Ordering Code**  
Bestell-Bezeichnung

Stok  
Stock  
Lager

ZEPF

Toplam  
Total  
Gesamt

Etkili  
Effective  
Effektiv

DC

CW

CDX

DCON

THUB

Takım Ölçüleri (mm)  
Dimension (mm)  
Abmessung (mm)

Kesici Uç  
Insert  
Wendeschneidplatte

Yedek Parçaları / Spare Parts / Ersatzteile

Sıkma Vidası  
Screw  
Schraube

Tork Anahtar  
Torx Key  
Torx-Schlüssel

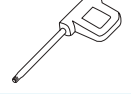

| Takım Kodu<br>Ordering Code<br>Bestell-Bezeichnung | Stok<br>Stock<br>Lager | Takım Ölçüleri (mm)<br>Dimension (mm)<br>Abmessung (mm) |    |     |     |      |      | Kesici Uç<br>Insert<br>Wendeschneidplatte   | Sıkma Vidası<br>Screw<br>Schraube | Tork Anahtar<br>Torx Key<br>Torx-Schlüssel |
|--|------------------------|---|----|-----|-----|------|------|---|-----------------------------------|--|
|  |                        | ZEPF  | DC | CW  | CDX | DCON | THUB |   |                                   |  |
| ASDM-CC06-D80x8-d27-Z10                            | ●                      | 10  | 5  | 80  | 8   | 17   | 27   | CC.T 0602..<br>ISO UCUNA<br>UYGUNDUR.<br>FOR ISO INSERT.<br>Kompatibel mit ISO<br>Wendeplatten. | 3008-M2.5x6                       | 82-T08                                     |
| ASDM-CC06-D100x8-d32-Z12                           | ●                      | 12  | 6  | 100 | 8   | 25   | 32   |   |                                   |  |
| ASDM-CC06-D125x8-d40-Z14                           | ●                      | 14  | 7  | 125 | 8   | 35   | 40   |   |                                   |  |
| ASDM-CC06-D160x8-d40-Z16                           | ●                      | 16  | 8  | 160 | 8   | 52   | 40   |   |                                   |  |
| ASDM-CC06-D200x8-d40-Z18                           | ●                      | 18  | 9  | 200 | 8   | 70   | 40   |   |                                   |  |
| ASDM-CC06-D80x10-d27-Z10                           | ●                      | 10  | 5  | 80  | 10  | 17   | 27   |   |                                   |  |
| ASDM-CC06-D100x10-d32-Z12                          | ●                      | 12  | 6  | 100 | 10  | 25   | 32   |   |                                   |  |
| ASDM-CC06-D125x10-d40-Z14                          | ●                      | 14  | 7  | 125 | 10  | 35   | 40   |   |                                   |  |
| ASDM-CC06-D160x10-d40-Z16                          | ●                      | 16  | 8  | 160 | 10  | 52   | 40   |   |                                   |  |
| ASDM-CC06-D200x10-d40-Z18                          | ●                      | 18  | 9  | 200 | 10  | 70   | 40   |   |                                   |  |
| ASDM-CC09-D80x12-d27-Z08                           | ●                      | 8   | 4  | 80  | 12  | 17   | 27   | CC.T 09T3..<br>ISO UCUNA<br>UYGUNDUR.<br>FOR ISO INSERT.<br>Kompatibel mit ISO<br>Wendeplatten. | 4015-M3.5x11                      | 80-T15                                     |
| ASDM-CC09-D100x12-d32-Z10                          | ●                      | 10  | 5  | 100 | 12  | 25   | 32   |   |                                   |  |
| ASDM-CC09-D125x12-d40-Z12                          | ●                      | 12  | 6  | 125 | 12  | 35   | 40   |   |                                   |  |
| ASDM-CC09-D160x12-d40-Z14                          | ●                      | 14  | 7  | 160 | 12  | 52   | 40   |   |                                   |  |
| ASDM-CC09-D200x12-d40-Z16                          | ●                      | 16  | 8  | 200 | 12  | 70   | 40   |   |                                   |  |
| ASDM-CC09-D80x14-d27-Z08                           | ●                      | 8   | 4  | 80  | 14  | 17   | 27   |   |                                   |  |
| ASDM-CC09-D100x14-d32-Z10                          | ●                      | 10  | 5  | 100 | 14  | 25   | 32   |   |                                   |  |
| ASDM-CC09-D125x14-d40-Z12                          | ●                      | 12  | 6  | 125 | 14  | 35   | 40   |   |                                   |  |
| ASDM-CC09-D160x14-d40-Z14                          | ●                      | 14  | 7  | 160 | 14  | 52   | 40   |   |                                   |  |
| ASDM-CC09-D200x14-d40-Z16                          | ●                      | 16  | 8  | 200 | 14  | 70   | 40   |   |                                   |  |
| ASDM-CC12-D80x16-d27-Z06                           | ●                      | 6   | 3  | 80  | 16  | 17   | 27   | CC.T 1204..<br>ISO UCUNA<br>UYGUNDUR.<br>FOR ISO INSERT.<br>Kompatibel mit ISO<br>Wendeplatten. | 1020-M5x11                        | 80-T20                                     |
| ASDM-CC12-D100x16-d32-Z08                          | ●                      | 8   | 4  | 100 | 16  | 25   | 32   |   |                                   |  |
| ASDM-CC12-D125x16-d40-Z10                          | ●                      | 10  | 5  | 125 | 16  | 35   | 40   |   |                                   |  |
| ASDM-CC12-D160x16-d40-Z12                          | ●                      | 12  | 6  | 160 | 16  | 52   | 40   |   |                                   |  |
| ASDM-CC12-D200x16-d40-Z14                          | ●                      | 14  | 7  | 200 | 16  | 70   | 40   |   |                                   |  |
| ASDM-CC12-D80x18-d27-Z06                           | ●                      | 6   | 3  | 80  | 18  | 17   | 27   |   |                                   |  |
| ASDM-CC12-D100x18-d32-Z08                          | ●                      | 8   | 4  | 100 | 18  | 25   | 32   |   |                                   |  |
| ASDM-CC12-D125x18-d40-Z10                          | ●                      | 10  | 5  | 125 | 18  | 35   | 40   |   |                                   |  |
| ASDM-CC12-D160x18-d40-Z12                          | ●                      | 12  | 6  | 160 | 18  | 52   | 40   |   |                                   |  |
| ASDM-CC12-D200x18-d40-Z14                          | ●                      | 14  | 7  | 200 | 18  | 70   | 40   |   |                                   |  |
| ASDM-CC12-D250x18-d40-Z16                          | ●                      | 16  | 8  | 250 | 18  | 90   | 40   |   |                                   |  |
| ASDM-CC12-D80x20-d27-Z06                           | ●                      | 6   | 3  | 80  | 20  | 17   | 27   |   |                                   |  |
| ASDM-CC12-D100x20-d32-Z08                          | ●                      | 8   | 4  | 100 | 20  | 25   | 32   |   |                                   |  |
| ASDM-CC12-D125x20-d40-Z10                          | ●                      | 10  | 5  | 125 | 20  | 35   | 40   |   |                                   |  |
| ASDM-CC12-D160x20-d40-Z12                          | ●                      | 12  | 6  | 160 | 20  | 52   | 40   |   |                                   |  |
| ASDM-CC12-D200x20-d40-Z14                          | ●                      | 14  | 7  | 200 | 20  | 70   | 40   |   |                                   |  |
| ASDM-CC12-D250x20-d40-Z16                          | ●                      | 16  | 8  | 250 | 20  | 90   | 40   |   |                                   |  |

R: Sağ / Right / Rechts L: Sol / Left / Links

● Stokta / In Stock / Auf Lager ○ Stokta Yok / Non Stock Item / Kein Lagerartikel, Lieferzeit auf Anfrage

Sipariş Örneği/Ordering Example/Bestellbeispiel

1 ad./pcs./stück ASDM-CC06-D80x8-d27-Z10

Kesme Hesabı : S 367 / Cutting Calculation : P 367 / Schnittberechnung : P 367

**konusulan**  
**the spoken kalite...**  
**quality...**



A TIP / A TYPE / A-Typ

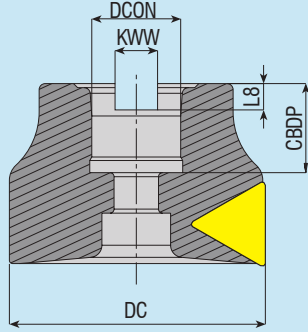

| DC  | DCON | DBC | KWW  | L8  | CBDP |
|-----|------|-----|------|-----|------|
| 40  | 16   | -   | 8.4  | 5.6 | 20   |
| 50  | 22   | -   | 10.4 | 6.3 | 22   |
| 63  | 22   | -   | 10.4 | 6.3 | 22   |
| 80  | 27   | -   | 12.4 | 7   | 25   |
| 100 | 32   | -   | 14.4 | 8   | 26   |

B TIP / B TYPE / B-Typ

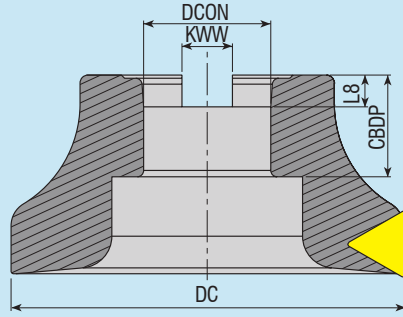

| DC  | DCON | DBC | KWW  | L8 | CBDP |
|-----|------|-----|------|----|------|
| 125 | 40   | -   | 16.4 | 9  | 32   |

C TIP / C TYPE / C-Typ

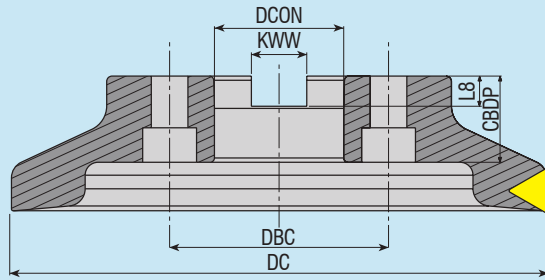

| DC  | DCON | DBC   | KWW  | L8 | CBDP |
|-----|------|-------|------|----|------|
| 160 | 40   | 66.7  | 16.4 | 9  | 32   |
| 200 | 60   | 101.6 | 25.7 | 14 | 40   |
| 250 | 60   | 101.6 | 25.7 | 14 | 40   |

D TIP / D TYPE / D-Typ

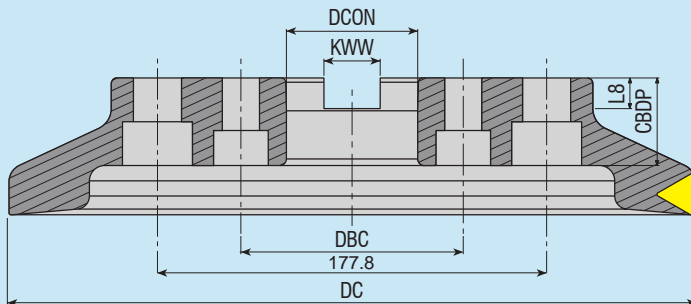

| DC  | DCON | DBC   | KWW  | L8 | CBDP |
|-----|------|-------|------|----|------|
| 315 | 60   | 101.6 | 25.7 | 14 | 40   |

## TAKMA UÇLU MATKAP (U-DRILL) KULLANMA KILAVUZU

Matkabınızı CNC torna tezgahına bağlamadan önce taretin merkezden kaçık olup olmadığını kontrol etmeniz gerekir. Şayet taretinizde kaçıklık varsa, takma uçlu matkabınızı kesinlikle kullanmayınız. Taretin düzeltilmesi için yapılması gereken işlemler ;

1. Taretin tutucusuna kullanacağınız takma uçlu matkabın çapında ve boyunda üzeri hassas olan silindirik bir parça bağlanır ve tazgahın X değeri sıfıra getirilir.
2. Tezgahın aynasına mıknatıslı komprotör saati yerleştirilir. Saatin uç kısmı tarete bağlanmış olduğumuz parçanın üstüne temas ettirilir.
3. Aynanın üzerine bağlanmış olduğumuz mıknatıslı komprotör ayna ile beraber 360 derece döndürülerek saatteki değişim oranına göre taretin sıfırlanması sağlanır.

## TAKMA UÇLU MATKABINIZI CNC TORNANIZDA DAHA VERİMLİ KULLANMANIZ İÇİN GEREKLİ OLAN KESME HIZLARI ve DEVİRLERİ :

| Grup No. | Malzemenin Cinsi               | Malzemenin Öz.        | Kesme Hızı Vc (m/dk) |
|----------|--------------------------------|-----------------------|----------------------|
| 1        | Çok Yumuşak İş Çelikleri       | C1010, Otomat vb.     | 220                  |
| 2        | İmalat Çelik ve Döküm Malz.    | C1030 - 106 vb.       | 200                  |
| 3        | Takım ve İmalat Çeşitleri      | CK-45, 4140, 7131 vb. | 170                  |
| 4        | Sıcak İş ve Paslanmaz Çelikler | İmpaks vb.            | 150                  |

Devir hesabı yapabilmek için önce malzemeyi seçiniz. Seçtiğiniz malzemenin kesme hızını (Vc) 1000 ile çarpıp 3.14'e bölmeliyiz. Çıkan değeri matkap çapına bölmeliyiz. **ÖRNEK** : Malzememiz takım ve imalat çeliği (3. grup), matkap çapı 25 mm kesme hızı 170 ise  $170 \times 1000 = 170000 / 3.14 = 54140$ ,  $54140 / 25 = 2166$  devir çıkar (Tezgahın İş Mili Devri). Tezgahın ilerlemesi kullanacağınız uç ile de alakalı olup 0.05 ile 0.10 arasında değişim gösterir. Kullanıcı kesici ucun kesişine göre bunu ayarlar.

## İŞLEME MERKEZLERİ İÇİN İLERLEME HESABI :

Yukarıdaki hesaplamalarla bulmuş olduğunuz 2166 iş mili devrini, kesici uç ilerlemesi (mm/devir) 0.05 ile 0.10 arasındaki ilerleme seçenekleri ile çarpılır. **ÖRNEK 1** :  $2166 \times 0.05 = 108$  **ÖRNEK 2** :  $2166 \times 0.10 = 217$  çıkan sonuçlar 108 ve 217 işleme merkezleri için ilerleme mm/dakika hesabıdır.

Not: D4 ve üzeri takma uçlu matkaplarda tezgahın içten su verme basıncının en az 6 bar olması gerekmektedir.

## USER'S GUIDE FOR AKKO U-DRILLS

Before connecting your U-Drill to CNC lathe, you have to check if the turret is eccentric from the center or not. If there is any eccentricity in your turret, never use your U-Drill;

Processes that should be done to fix the turret :

1. A cylindrical part whose surface is precision and whose length and diameter is the same with the U-Drill that you will use, should be mounted to the holder of turret and X value of the lathe should be brought to zero ( 0 ).
2. Comparator should be mounted to chuck. The end of the comparator should be contacted ( touched ) to the surface of the part that we mounted on the turret.
3. The comparator that we mounted on the chuck should be turned 360-degree with the chuck and turret should be zeroed by that turning according to changing rate of comparator.

## CUTTING SPEED AND REVOLUTION THAT ARE NEEDED FOR USING ( RUNNING ) YOUR U-DRILLS MORE PRODUCTIVELY

| Grup No. | Material                               | Material Type          | Cutting Speed Vc ( m/m) |
|----------|--|------------------------|-------------------------|
| 1        | Non-alloy steel and free cutting steel | C1010. Automat etc.    | 220                     |
| 2        | Low alloy steel and cast steel         | C1030 - 106 etc.       | 200                     |
| 3        | Alloy steel and tool steel             | CK-45, 4140, 7131 etc. | 170                     |
| 4        | Hot Work Steel and Stainless Steel     | Impax etc.             | 150                     |

P.S. : The cutting speed may be concerned with the type of the insert that you use.

Fistly, choose the material to make calculation of revolution. You should multiply the cutting speed (Vc) of the material that you chose by 1000 and divide by 3.14. You should divide the value that you found by the diameter of U-Drill. For Example : If our material is alloy steel and tool steel ( 3rd group ), diameter of the U-Drill is 25 mm, cutting speed is 170, we should calculate as following;  $170 \times 1000 = 170000 / 3.14 = 54140$ ,  $54140 / 25 = 2166$  rpm is the result that we found ( Spindle Speed ) Feed rate of the lathe is concerned with the U-Drill that you will use and changes between 0.05 and 0.10. The user sets it according to cut of cutting insert.

## FEED CALCULATION FOR CENTRAL MACHINE :

2166 spindle speed, that we found as a result of above mentioned calculation, should be multiplied by cutting insert feed ( mm/r ) between 0.05 and 0.10 feed choisses. Example 1 :  $2166 \times 0.05 = 108$

Example 2 :  $2166 \times 0.10 = 217$  The results 108 and 217 are the feed mm/m calculation for central machine.

Note: Cooling water pressure of lathe must be minimum 6 bar for our D4 u-drills and u-drills longer than D4.

## GEBRAUCHSANLEITUNG FÜR AKKO-VOLLBOHRER

Bevor Sie den Vollbohrer auf die Drehmaschine montieren, prüfen Sie bitte ob der Revolverkopf zentrisch sitzt. Sollte der Revolverkopf aus der Mitte stehen, benutzen Sie den Vollbohrer bitte nicht. Auf folgende Weise können Sie den Revolverkopf zentrieren:

1. Setzen Sie ein präzises Drehteil, das die gleiche Länge und den gleichen Durchmesser hat wie der eingesetzte Vollbohrer, in den Halter vom Revolverkopf und justieren Sie den X-Wert der Drehmaschine auf null.
2. Setzen Sie bitte einen Messtaster in das Spannfutter ein. Der Fühler des Messtasters sollte mit der Oberfläche des Präzisionsteils im Revolver Kontakt haben.
3. Drehen Sie nun das Spannfutter mit dem Messtaster um 360°. Die angezeigte Abweichung zwischen Futter und Revolver sollte null betragen.

### SCHNITTGESCHWINDIGKEIT UND DREHZAHL UM DIE VOLLBOHRER WIRTSCHAFTLICH EINZUSETZEN

| Hauptgruppe | Hauptgruppe                              | Materialbezeichnung                   | Schnittgeschwindigkeit vc (m/min.) |
|-------------|--|---------------------------------------|------------------------------------|
| 1           | Nicht Legierter Stahl und Automatenstahl | C1010. Automatenstahl                 | 220                                |
| 2           | Niedrig Legierter Stahl und Stahlguss    | C1030 - 106 vb.                       | 200                                |
| 3           | Legierter Stahl und Werkzeugstahl        | CK-45, 4140, 7131 vb.                 | 170                                |
| 4           | Warmarbeitsstahl und Rostfreier Stahl    | Impax und weitere Chrom-Nickel-Stähle | 150                                |

P.S.: Die genaue Schnittgeschwindigkeit hängt von der verwendeten Wendeschneidplatte ab.

In Abhängigkeit vom Material wählen Sie die Schnittgeschwindigkeit vc. Diesen Wert multiplizieren Sie mit 1000 und teilen ihn durch 3,14 und den Durchmesser des Werkzeugs (in mm).

Beispiel: Rostfreier Stahl (Hauptgruppe 3), Werkzeugdurchmesser 25 mm, Schnittgeschwindigkeit vc=170 m/min. Die Berechnung sieht wie folgt aus:  $170 \times 1000 = 170000 / 3,14 = 54140 / 25 = 2166$  U/min. (Spindeldrehzahl). Der Vorschub der Maschine hängt vom Vollbohrer und der verwendeten Wendeschneidplatte ab und variiert zwischen 0,05 mm und 0,1 mm / Umdrehung.

### VORSCHRUBBERECHNUNG :

Die oben berechnete Spindeldrehzahl von 2166 wird mit dem Vorschub 0,05 mm und 0,1 mm multipliziert.  $2166 \text{ Umdr./min.} \times 0,05 \text{ mm/Umdr.} = 108 \text{ mm/min.}$   $2166 \text{ Umdr./min.} \times 0,1 \text{ mm/Umdr.} = 216 \text{ mm/min.}$  D.h. der Vorschub liegt zwischen 108 mm/min. und 216 mm/min. Hinweis: Der Kühlmitteldruck muss mindestens 6 bar betragen für die Vollbohrer mit  $\geq 4xD$

## SIKMA TORKU TAVSİYELERİ - RECOMMENDED TIGHTENING TORQUE EMPFOLHENES ANZUGSMOMENT

- Takımı Sıkmadan Önce Aşağıdaki Bilgileri Okuyunuz.  
*Read below information before tightening the tool.*  
*Bitte lesen Sie die nachfolgenden Informationen bevor Sie das Werkzeug spannen.*
- Vidalı Takımın Vida Ölçüsü ile Tutucunun İç Vida Ölçüsünü Sıkmadan Önce Kontrol Ediniz.  
*Check screw set's the screw size and together with mounting arbor inner dimension of screws.*  
*Prüfen Sie, ob das Gewinde vom Werkzeug mit dem Gewinde in der Verlängerung identisch ist.*
- Takımı Tutucuya Sıkarken Tablodaki İlgili Değerlere Göre İşlem Yapınız.  
*When tightening head to an arbor, follow the related tightening torque in the table.*  
*Wenn Sie den Einschraubfräser festziehen, beachten Sie bitte die angegebenen Anzugsmomente.*

| Vida<br>Screw<br>Schraube | Tork<br>Torque (N.m)<br>Anzugsmoment (N.m) |
|---------------------------|--|
| M6                        | 8  |
| M8                        | 23   |
| M10                       | 46   |
| M12                       | 80   |
| M16                       | 90   |





## FREZELEME İŞLEMİNDE DEVİR ve İLERLEME HESABI

| Vc.  | S                          | D                        | F        | Z                                  | fz  | FORMÜLLER   |
|--|----------------------------|--------------------------|----------|------------------------------------|---|---|
| Kesme Hızı<br>(Uç Kutusunun<br>Arkasından<br>Okuyunuz) | İş Mili<br>Devir<br>Sayısı | Tarama<br>Kafası<br>Çapı | İlerleme | Tarama<br>Kafası<br>Ağız<br>Sayısı | Diş Başına Düşen<br>İlerleme Miktarı<br>(Uç Kutusunun<br>Arkasından Okuyunuz) | Devir Hesabı :<br>$S=(Vc \times 1000) / (3,14 \times D)$<br>İlerleme Hesabı :<br>$F=S \times Z \times fz$ |

**Örnek :** D=50 mm çapında, Z=5 ağızlı tarama kafası ile frezeleme yapacağız. Kesici uç kutusunun arkasında kesme hızı Vc=200m/dk. olarak verilmiş olsun. Tezgaha girilecek devri hesaplayalım: **Vc=200 m/dk. D=50 mm S =** Öncelikle Kesme Hızı 1000 ile çarpılır, çıkan sonuç 3,14 sayısına bölünür, buradan çıkan sonuç da tarama kafası çapına bölünür.

$S=200 \times 1000 = 200000 \rightarrow 200000/3,14=63663 \rightarrow 63663/50=1273$  devir **S=1273 dev/dakika** devri bulduktan sonra ilerlemeyi bulalım: **Z=5** ağızlı tarama kafası olsun **fz=0,12** olarak uç kutusunun arkasından okunmuş olsun F= yukarıda bulmuş olduğumuz devir sayısı ile ağız sayısı çarpılır, çıkan sonuç diş başına düşen ilerleme miktarı ile çarpılır.

$F=1273 \times 5 = 6365 \rightarrow 6365 \times 0,12 = 763$   $F=763$  mm/dakika

Tezgaha girilecek olan devir = S 1273 Tezgaha girilecek olan ilerleme : **F 763 ortalama değerdir.**

**Not:** Vc ve fz değerlerinin uç kutusunun arkasında verilmiş olması gerekir. Eğer bu değerler uç kutusunun üzerinde yoksa, kesici ucun katalogundan bulunuz. İşleyeceğiniz malzeme çelik ise P, paslanmaz çelik ise M, dökme demir ise K bölümünde yazılı olan Vc ve fz değerlerini okuyun.

## CALCULATING SPINDLE SPEED and FEED RATE FOR MILLING PROCESS

| Vc.   | S                            | D                           | F            | Z                               | fz   | FORMULAS   |
|---|------------------------------|-----------------------------|--------------|---------------------------------|--|--|
| Cutting Speed<br>(Please read<br>from the back-<br>side of cutting<br>insert box) | Spindle<br>Revolution<br>rpm | Milling<br>Tool<br>Diameter | Feed<br>Rate | Number of<br>Effective<br>Tooth | Feed Per Tooth<br>(Please Read From<br>The Back Side of Cutting<br>Insert Box) | Calculation of Revolution :<br>$S=(Vc \times 1000) / (3,14 \times D)$<br>Feed Rate Calculation :<br>$F=S \times Z \times fz$ |

For Example : We will make milling with milling tool whose diameter is D 50 mm, whose teeth number is Z=5. The spindle revolution was written as Vc=200m/mn at the back side of cutting insert box. Let's calculate the revolution that should be entered to the milling machine : Vc=200 m/mn D=50 mm  
S = Firstly Cutting Speed is multiplied with 1000, the result should be divided by 3.14 , the last result should be divided by diameter of milling tool.

$S = 200 \times 1000 = 200000 \rightarrow 200000/3,14 = 63663 \rightarrow 63663/50 = 1273$  rev  $S=1273$  rev / mn

After finding spindle revolution, let's find feed rate : milling tool with Z=5 teeth and we read fz=0,12 from the back side of cutting insert box.

F = Tooth number should be multiplied with revolution, the result should be multiplied with feed per tooth.

$F = 1273 \times 5 = 6365 \rightarrow 6365 \times 0,12 = 763$   $F = 763$  mm / mn

Revolution that should be entered to the milling machine = S 1273 Feed Rate that should be entered to the milling machine = F 763 average value.

P.S : The values Vc and fz has to be written at the back side of the cutting insert. If these values were not written on the cutting insert box, please find them from cutting insert catalogue. If the material that you will work is steel, please read Vc and fz values that were written on the part P, if it is stainless steel please read from the part M, if it is cast iron please read from the part K.

## BERECHNUNG VON DREHZAHL UND VORSCHUB FÜR FRÄSWERKZEUGE

| Vc.  | S                   | D                           | F                       | Z                                 | fz   | Formeln   |
|--|---------------------|-----------------------------|-------------------------|-----------------------------------|--|---|
| Schnittgeschwindigkeit<br>(finden<br>Sie z.B. auf der<br>Verpackung der<br>Wendeschneidplatte) | Spindel<br>Drehzahl | Fräswerkzeug<br>Durchmesser | Vorschubgeschwindigkeit | Anzahl der<br>effektiven<br>Zähne | Vorschub pro Zahn (finden Sie z.B. auf der<br>Verpackung der Wendeschneidplatte) | Berechnung der Drehzahl:<br>$n=(vc \times 1000) / (3,14 \times D)$<br>Vorschubberechnung:<br>$F=n \times Z \times fz$ |

Beispiel: Fräswerkzeug mit D=50 mm und Z=5. Schnittgeschwindigkeit vc=200 m/min. (laut Wendeschneidplattenverpackung).

Berechnung der Drehzahl:  $n=200 \text{ m/min.} \times 1000 = 200000 / 3,14=63694 / 50 \text{ mm} = 1273$  Umdr./min.

Berechnung des Vorschubs: Ermittlung von fz (finden Sie z.B. auf der Verpackung der Wendeschneidplatte), für das Berechnungsbeispiel

$fz=0,12 \text{ mm}$   $F = n \times Z \times fz = 1273 \times 5 \times 0,12 = 763 \text{ mm/min.}$  D.h., Sie stellen an der Maschine folgende Werte ein: Drehzahl n = 1273 Umdr./min., Vorschub F = 763 mm/min.

P.S.: Die Werte für vc und fz finden Sie auf der Rückseite der Wendeschneidplattenverpackung. Sollten diese Werte dort nicht stehen, können Sie diese auch im Wendeschneidplattenkatalog finden. Für Stahl wählen Sie für vc und fz bitte die Werte aus dem Bereich P, für rostfreien Stahl aus dem Bereich M und für Guss aus dem Bereich K.

## Gövde Malzemesine Göre Delik İçi Kater Uygulama Kılavuzu

### Internal Boring Bars Application Guide, Related to Body Material

#### Anwendungshinweise für Bohrstangen, abhängig vom Bohrstangen-Material

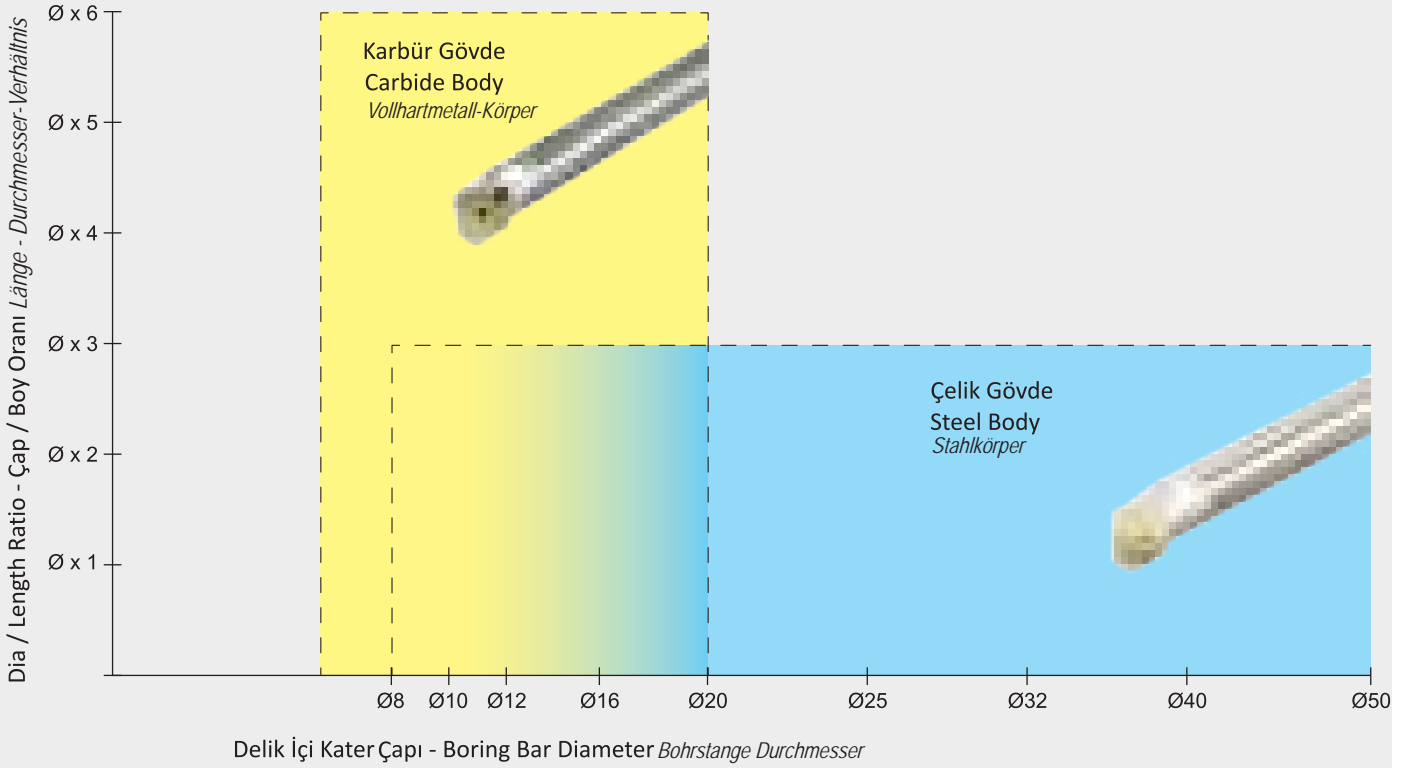

## T Kanal Freze Kullanım ve Ön Hazırlama Kılavuzu

### Application Guide For T-Slot Milling

#### Anwendungshinweise für T-Nutenfräser

T kanal frezelemede talaşın rahat boşaltılması için iş parçası resimde gösterildiği şekilde işlenmelidir.

Örnek: ATSM90-CC06- D32X10-W25- L100-Z04 kodlu T freze ile kanal açmadan önce, takımın boğazının çalışacağı kısmın parmak freze ile işlenmesi gerekir. Bu durumda kanalın tamamen işlenmesi çok yanlıştır. Tabanda ( $0.8 \times b = 0.8 \times 10$ ) 8mm işlenmeden bırakılmalıdır. Bu bölgeyi T frezenin işlemesi, takımın daha sağlıklı çalışması açısından gereklidir.

İşlenen kanallarda yumuşak kesim için talaşlar uzaklaştırılmış olmalıdır.

When T slot machining steel, the workpiece must be machined as shown in the drawing to ensure smooth chip evacuation.

Example: Before slotting with the T - slot milling cutter - code ATSM90-CC06-D32X10-W25-L100-Z04,

The area of the neck of the tools to be worked and must be machined by End-Mill.

In this case, it is very wrong to machining the slot completely.

Bottom area ( $0.8 \times b = 0.8 \times 10$ ) should be left 8 mm without machining.

This area's operation must be machined by the T - slot milling cutter which is also necessary for the healthier work of the tool holder. Slots to be machined must be free from chips for smooth machining.

Beim Einsatz von T-Nutenfräsern muss das Werkstück so bearbeitet werden wie es in der Zeichnung dargestellt ist, um einen problemlosen Spänetransport zu gewährleisten.

Bespiel: Einsatz des T-Nutenfräasers ATSM90-CC06-D32X10-W25-L100-Z04

Die Aussparung für den Halsbereich des T-Nutenfräasers muss mit einem Schaftfräser vorgearbeitet werden. Bitte beachten Sie dabei, dass die Aussparung nicht komplett bis auf den Grund gefräst wird, sondern eine Bodenstärke von  $0,8 \times b$  (im Beispiel  $0,8 \times 10 \text{ mm} = 8 \text{ mm}$ ) im Werkstück verbleibt.

Dieser Bereich soll mit dem T-Nutenfräser bearbeitet werden, da dies für die Stabilität und Standzeit des Werkzeugs besser ist.

In der zu bearbeitenden Nut sollten keine Späne mehr vorhanden sei.

### KULLANIM İÇİN UYARI

#### CAUTION FOR USE

Bitte beachten Sie!

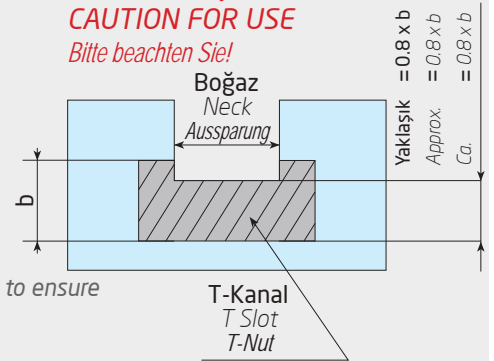

**α = 5 Kat Dayanıklılık****α = 5 Times Long Life****α = 5-Fache Standzeit**

## Alfa Kaplamanın Avantajları

Alpha Coating  
Advantages

Vorteile der  
Alpha-Beschichtung

- **Yüksek aşınma direnci**  
High resistance to abrasion  
Hoher Verschleißschutz
- **Yüksek yüzey sertliği**  
750-800 Vickers  
High surface hardness  
750-800 Vickers  
Hohe Oberflächenhärte von  
750-800 HV
- **Temperlemeye karşı yüksek direnç**  
High resistance to tempering  
Hoher Temperaturwiderstand
- **Yüksek yorulma mukavemeti**  
High fatigue strength  
Hohe Dauerfestigkeit
- **Yüksek çizik ve çentik direnci**  
High scratch and impact resistance  
Hoher Kratz- und Stoß-Widerstand
- **Paslanmaz olmayan çelikler için daha yüksek korozyon direnci**  
Resistant to corrosion of  
non-stainless steel  
Korrosionsschutz

takımınız neden  
**daha uzun ömürlü**  
olmasın?...

**longer tool life...**

**längere Werkzeug-Standzeit**



**α Çevre Dostudur. α is friend of environment.**  
α ist umweltfreundlich.

**İnsan sağlığı açısından zararlı değildir. Is not harmful to human health.**  
Nicht gesundheitsschädlich.

**Gas ve diğer atıklar çevreyi kirlilemez. Gas and other wastes will not pollute the environment.**  
Umweltverträgliches Beschichtungsverfahren.

ALTLIKLAR / SHIMS / UNTERLAGE

| ÜRÜN RESMİ/PICTURE<br>BILD | ÜRÜN KODU/CODE<br>BEZEICHNUNG | ÜRÜN DETAYI / PRODUCT DETAIL<br>PRODUKTBESCHREIBUNG   |   |
|----------------------------|-------------------------------|---|---|
|                            | <b>AATN-2-0001</b>            | S-SİSTEM için / For S-SYSTEM / FÜR S-SYSTEM   | TCMT 16 ALTLIK / SHIM / UNTERLAGE                   |
|                            | <b>AATN-2-0002</b>            | T-M SİSTEM için / For T-M SYSTEM / FÜR T-M-SYSTEM   | TNMG 16 ALTLIK / SHIM / UNTERLAGE                   |
|                            | <b>AATN-3-0025</b>            | C-SİSTEM için / For C-SYSTEM / FÜR C-SYSTEM   | TNGN 16 ALTLIK / SHIM / UNTERLAGE                   |
|                            | <b>AATN-3-0015</b>            | P-SİSTEM için / For P-SYSTEM / FÜR P-SYSTEM   | TNMG 16 ALTLIK / SHIM / UNTERLAGE                   |
|                            | <b>AATN-2-0020</b>            | T-M-P SİSTEM için / For T-M SYSTEM / FÜR T-M-P-SYSTEM   | TNMG 22 ALTLIK / SHIM / UNTERLAGE                   |
|                            | <b>AATN-2-0004</b>            | DİŞ VİDA 16 ALTLIK / For THREADING 16 SHIM / 16 SHIM / GEWINDE 16 UNTERLAGE   |   |
|                            | <b>AATN-2-0004</b>            | DİŞ VİDA 22 ALTLIK / For THREADING 22 SHIM / GEWINDE 22 UNTERLAGE   |   |
|                            | <b>ATS-16E</b>                | DİŞ VİDA 16, DİŞ ÇAP SAĞ - DELİK İÇİ SOL ALTLIK / For THREADING SYSTEM 16 SHIM, EXTERNAL RIGHT-INTERNAL LEFT / FÜR 16 ER-GEWINDEPLATTE, EXTERN RECHTS- INTERN LINKS |   |
|                            | <b>ATS-16I</b>                | DİŞ VİDA 16, DİŞ ÇAP SOL - DELİK İÇİ SAĞ ALTLIK / For THREADING SYSTEM 16 SHIM, EXTERNAL LEFT-INTERNAL RIGHT / FÜR 16 ER-GEWINDEPLATTE, EXTERN LINKS- INTERN RECHTS |   |
|                            | <b>ATS-22E</b>                | DİŞ VİDA 22, DİŞ ÇAP SAĞ - DELİK İÇİ SOL ALTLIK / For THREADING SYSTEM 22 SHIM, EXTERNAL RIGHT-INTERNAL LEFT / FÜR 22 ER-GEWINDEPLATTE, EXTERN RECHTS- INTERN LINKS |   |
|                            | <b>ATS-22I</b>                | DİŞ VİDA 22, DİŞ ÇAP SOL - DELİK İÇİ SAĞ ALTLIK / For THREADING SYSTEM 22 SHIM, EXTERNAL LEFT-INTERNAL RIGHT / FÜR 22 ER-GEWINDEPLATTE, EXTERN LINKS- INTERN RECHTS |   |
|                            | <b>ATS-27E</b>                | DİŞ VİDA 27, DİŞ ÇAP SAĞ - DELİK İÇİ SOL ALTLIK / For THREADING SYSTEM 27 SHIM, EXTERNAL RIGHT-INTERNAL LEFT / FÜR 27 ER-GEWINDEPLATTE, EXTERN RECHTS- INTERN LINKS |   |
|                            | <b>ATS-27I</b>                | DİŞ VİDA 27, DİŞ ÇAP SOL - DELİK İÇİ SAĞ ALTLIK / For THREADING SYSTEM 27 SHIM, EXTERNAL LEFT-INTERNAL RIGHT / FÜR 27 ER-GEWINDEPLATTE, EXTERN LINKS- INTERN RECHTS |   |
|                            | <b>AACN-2-0001</b>            | S-SİSTEM için / For S-SYSTEM / FÜR S-SYSTEM   | CCMT 09 ALTLIK / SHIM / UNTERLAGE                   |
|                            | <b>AACN-2-0002</b>            | T-SİSTEM için / For T-SYSTEM / FÜR T-SYSTEM   | CNMG 09 ALTLIK / SHIM / UNTERLAGE                   |
|                            | <b>AACN-2-0003</b>            | P-SİSTEM için / For P-SYSTEM / FÜR P-SYSTEM   | CNMG 09 ALTLIK / SHIM / UNTERLAGE                   |
|                            | <b>AACN-2-0003</b>            | S-SİSTEM için / For S-SYSTEM / FÜR S-SYSTEM   | CCMT 12 ALTLIK / SHIM / UNTERLAGE                   |
|                            | <b>AACN-3-0001</b>            | T-M-P SİSTEM için / For T-M-P SYSTEM / FÜR T-M-P-SYSTEM   | CNMG 12 ALTLIK / SHIM / UNTERLAGE                   |
|                            | <b>AACN-3-0002</b>            | C-SİSTEM için / For C-SYSTEM / FÜR C-SYSTEM   | CNGN 12 ALTLIK / SHIM / UNTERLAGE                   |
|                            | <b>AACN-3-0002</b>            | T-P SİSTEM için / For T-P SYSTEM / FÜR T-P-SYSTEM   | CNMG 16 ALTLIK / SHIM / UNTERLAGE                   |
|                            | <b>AACN-3-0003</b>            | T-P SİSTEM için / For T-P SYSTEM / FÜR T-P-SYSTEM   | CNMG 19 ALTLIK / SHIM / UNTERLAGE                   |
|                            | <b>AACN-3-0008</b>            | T-P SİSTEM için / For T-P SYSTEM / FÜR T-P-SYSTEM   | CNMG 25 ALTLIK / SHIM / UNTERLAGE                   |
|                            | <b>AAWN-2-0003</b>            | T-M-P SİSTEM için / For T-M-P SYSTEM / FÜR T-M-P-SYSTEM   | WNMG 08 KALIN ALTLIK / THICK SHIM / DICKE UNTERLAGE |
|                            | <b>AAWN-3-0001</b>            | T-M-P SİSTEM için / For T-M-P SYSTEM / FÜR T-M-P-SYSTEM   | WNMG 08 ALTLIK / SHIM / UNTERLAGE                   |
|                            | <b>AAWN-SW317</b>             | T-M-P SİSTEM için / For T-M-P SYSTEM / FÜR T-M-P-SYSTEM   | WNMG 06 ALTLIK / SHIM / UNTERLAGE                   |
|                            | <b>AKS-16L</b>                | C-SİSTEM için / For C-SYSTEM / FÜR C-SYSTEM   | KNUX-L 16 ALTLIK / SHIM / UNTERLAGE                 |
|                            | <b>AKS-16R</b>                | C-SİSTEM için / For C-SYSTEM / FÜR C-SYSTEM   | KNUX-R 16 ALTLIK / SHIM / UNTERLAGE                 |
|                            | <b>AASD-3-0001</b>            | S-SİSTEM FREZELEME için / For S-SYSTEM MILLING / S-SYSTEM FÜR FRÄSER  | SDMT 12 ALTLIK / SHIM / UNTERLAGE                   |
|                            | <b>AASE-3-0001</b>            | S-SİSTEM FREZELEME için / For S-SYSTEM MILLING / S-SYSTEM FÜR FRÄSER  | SEMT 13 ALTLIK / SHIM / UNTERLAGE                   |
|                            | <b>AASN-2-0001</b>            | S-SİSTEM için / For S-SYSTEM / FÜR S-SYSTEM   | SCMT 09 ALTLIK / SHIM / UNTERLAGE                   |
|                            | <b>AASN-2-0002</b>            | P-SİSTEM için / For P-SYSTEM / FÜR P-SYSTEM   | SNMG 09 ALTLIK / SHIM / UNTERLAGE                   |
|                            | <b>AASN-2-0004</b>            | S-SİSTEM için / For S-SYSTEM / FÜR S-SYSTEM   | SCMT 12 ALTLIK / SHIM / UNTERLAGE                   |
|                            | <b>AASN-3-0004</b>            | T-P SİSTEM için / For T-P SYSTEM / FÜR T-P-SYSTEM   | SNMG 12 ALTLIK / SHIM / UNTERLAGE                   |
|                            | <b>AASN-3-0004</b>            | C-SİSTEM için / For C-SYSTEM / FÜR C-SYSTEM   | SNGN 12 ALTLIK / SHIM / UNTERLAGE                   |
|                            | <b>AASN-3-0023</b>            | T-P SİSTEM için / For T-P SYSTEM / T-P TMT  | SNMG 15 ALTLIK / SHIM / UNTERLAGE                   |
|                            | <b>AASN-3-0005</b>            | T-P SİSTEM için / For T-P SYSTEM / FÜR T-P-SYSTEM   | SNMG 19 ALTLIK / SHIM / UNTERLAGE                   |
|                            | <b>AASN-3-0020</b>            | T-P SİSTEM için / For T-P SYSTEM / FÜR T-P-SYSTEM   | SNMG 25 ALTLIK / SHIM / UNTERLAGE                   |
|                            | <b>AASN-20020</b>             | PSDNN KARTUŞ için / For PSDNN CARTRIDGE / FÜR PSDNN-KURZDREHHALTER  | SNMG 12 ALTLIK / SHIM / UNTERLAGE                   |
|                            | <b>AADN-2-0001</b>            | S-SİSTEM için / For S-SYSTEM / FÜR S-SYSTEM   | DCMT 11 ALTLIK / SHIM / UNTERLAGE                   |
|                            | <b>AADN-2-0001</b>            | T-SİSTEM için / For T-SYSTEM / FÜR T-SYSTEM   | DNMG 11 ALTLIK / SHIM / UNTERLAGE                   |
|                            | <b>AADN-SD317</b>             | P-SİSTEM için / For P-SYSTEM / FÜR P-SYSTEM   | DNMG 11 ALTLIK / SHIM / UNTERLAGE                   |
|                            | <b>AADN-3-0001</b>            | T-M-P SİSTEM için / For T-M-P SYSTEM / FÜR T-M-P-SYSTEM   | DNMG 15 ALTLIK / SHIM / UNTERLAGE                   |
|                            | <b>AADN-3-0001</b>            | C-SİSTEM için / For C-SYSTEM / FÜR C-SYSTEM   | DNGN 15 ALTLIK / SHIM / UNTERLAGE                   |
|                            | <b>AADN-2-0003</b>            | T-SİSTEM için / For T-SYSTEM / FÜR T-SYSTEM   | DNMG 15 KALIN ALTLIK / THICK SHIM / DICKE UNTERLAGE |
|                            | <b>AAVN-2-0002</b>            | S-SİSTEM için / For S-SYSTEM / FÜR S-SYSTEM   | VBMT 16, VCMT 16 ALTLIK / SHIM / UNTERLAGE          |
|                            | <b>AAVN-2-0002</b>            | T-SİSTEM için / For T-SYSTEM / FÜR T-SYSTEM   | VNMG 16 ALTLIK / SHIM / UNTERLAGE                   |
|                            | <b>AAVN-2-0003</b>            | S-SİSTEM için / For S-SYSTEM / FÜR S-SYSTEM   | VCMT 22 ALTLIK / SHIM / UNTERLAGE                   |
|                            | <b>AARC-3-0001</b>            | C-SİSTEM için / For C-SYSTEM / FÜR C-SYSTEM   | RCGX 06 ALTLIK / SHIM / UNTERLAGE                   |
|                            | <b>AARC-3-0002</b>            | C-SİSTEM için / For C-SYSTEM / FÜR C-SYSTEM   | RCGX 09 ALTLIK / SHIM / UNTERLAGE                   |
|                            | <b>AARC-3-0003</b>            | C-SİSTEM için / For C-SYSTEM / FÜR C-SYSTEM   | RCGX 12 ALTLIK / SHIM / UNTERLAGE                   |

BASKI PABUÇLARI / CLAMPS / SPANNSPRATZE

| ÜRÜN RESMİ/PICTURE<br>BILD | ÜRÜN KODU/CODE<br>BEZEICHNUNG | ÜRÜN DETAYI / PRODUCT DETAIL<br>PRODUKTBESCHREIBUNG   |
|----------------------------|-------------------------------|---|
|                            | <b>ATK-01</b>                 | T-SİSTEM için / For T-SYSTEM / FÜR T-SYSTEM<br>DNMG 11, WNMG 06, TNMG 16,<br>CNMG 09 BASKI PABUCU / CLAMP / PRATZE  |
|                            | <b>ATK-02</b>                 | T-SİSTEM için / For T-SYSTEM / FÜR T-SYSTEM<br>CNMG 12, WNMG 08, TNMG 22,<br>DNMG 15, SNMG 12 BASKI PABUCU / CLAMP / PRATZE   |
|                            | <b>ATK-03</b>                 | T-SİSTEM için / For T-SYSTEM / FÜR T-SYSTEM<br>VNMG 16 BASKI PABUCU / CLAMP / PRATZE  |
|                            | <b>ATK-04</b>                 | T-SİSTEM için / For T-SYSTEM / FÜR T-SYSTEM<br>CNMG 16, SNMG 15 BASKI PABUCU / CLAMP / PRATZE   |
|                            | <b>ATKH-01-R</b>              | T-SİSTEM için / For T-SYSTEM / FÜR T-SYSTEM<br>İÇTEN SOĞUTMA KANALLI BASKI PABUCU / WITH COOLANT TOOLS / INNENKÜHLUNG   |
|                            | <b>ATKH-02-L</b>              | T-SİSTEM için / For T-SYSTEM / FÜR T-SYSTEM<br>İÇTEN SOĞUTMA KANALLI BASKI PABUCU / WITH COOLANT TOOLS / INNENKÜHLUNG   |
|                            | <b>ATKH-03-R</b>              | T-SİSTEM için / For T-SYSTEM / FÜR T-SYSTEM<br>İÇTEN SOĞUTMA KANALLI BASKI PABUCU / WITH COOLANT TOOLS / INNENKÜHLUNG   |
|                            | <b>ATKH-04-L</b>              | T-SİSTEM için / For T-SYSTEM / FÜR T-SYSTEM<br>İÇTEN SOĞUTMA KANALLI BASKI PABUCU / WITH COOLANT TOOLS / INNENKÜHLUNG   |
|                            | <b>ATKH-05-R</b>              | T-SİSTEM için / For T-SYSTEM / FÜR T-SYSTEM<br>İÇTEN SOĞUTMA KANALLI BASKI PABUCU / WITH COOLANT TOOLS / INNENKÜHLUNG   |
|                            | <b>ATKH-06-L</b>              | T-SİSTEM için / For T-SYSTEM / FÜR T-SYSTEM<br>İÇTEN SOĞUTMA KANALLI BASKI PABUCU / WITH COOLANT TOOLS / INNENKÜHLUNG   |
|                            | <b>ATKH-07-R</b>              | T-SİSTEM için / For T-SYSTEM / FÜR T-SYSTEM<br>İÇTEN SOĞUTMA KANALLI BASKI PABUCU / WITH COOLANT TOOLS / INNENKÜHLUNG   |
|                            | <b>ATKH-08-L</b>              | T-SİSTEM için / For T-SYSTEM / FÜR T-SYSTEM<br>İÇTEN SOĞUTMA KANALLI BASKI PABUCU / WITH COOLANT TOOLS / INNENKÜHLUNG   |
|                            | <b>ATKH-09-R</b>              | T-SİSTEM için / For T-SYSTEM / FÜR T-SYSTEM<br>İÇTEN SOĞUTMA KANALLI BASKI PABUCU / WITH COOLANT TOOLS / INNENKÜHLUNG   |
|                            | <b>ATKH-10-L</b>              | T-SİSTEM için / For T-SYSTEM / FÜR T-SYSTEM<br>İÇTEN SOĞUTMA KANALLI BASKI PABUCU / WITH COOLANT TOOLS / INNENKÜHLUNG   |
|                            | <b>AMK-01</b>                 | M-SİSTEM için / For M-SYSTEM / FÜR M-SYSTEM<br>WNMG 06 BASKI PABUCU / CLAMP / PRATZE  |
|                            | <b>AMK-02</b>                 | M-SİSTEM için / For M-SYSTEM / FÜR M-SYSTEM<br>DELİK İÇİ / INTERNAL Ø20 TNMG 16, Ø25 MT-NR/L 16 BASKI PABUCU / CLAMP / PRATZE   |
|                            | <b>AMK-03</b>                 | M-SİSTEM için / For M-SYSTEM / FÜR M-SYSTEM<br>DNMG 11, CNMG 12 BASKI PABUCU / CLAMP / PRATZE   |
|                            | <b>AMK-04</b>                 | M-SİSTEM için / For M-SYSTEM / FÜR M-SYSTEM<br>DNMG 15, TNMG 16-22 BASKI PABUCU / CLAMP / PRATZE  |
|                            | <b>AMK-05</b>                 | M-SİSTEM için / For M-SYSTEM / FÜR M-SYSTEM<br>WNMG 08 BASKI PABUCU / CLAMP / PRATZE  |
|                            | <b>AMK-07</b>                 | M-SİSTEM için / For M-SYSTEM / FÜR M-SYSTEM<br>S20R MCLNR/L BASKI PABUCU / CLAMP / PRATZE   |
|                            | <b>AMK-08</b>                 | M-SİSTEM için / For M-SYSTEM / FÜR M-SYSTEM<br>TNMG 22 BASKI PABUCU / CLAMP / PRATZE  |
|                            | <b>ACK-01-R</b>               | C-SİSTEM için / For C-SYSTEM / FÜR C-SYSTEM<br>KNUX-R BASKI PABUCU / CLAMP / PRATZE   |
|                            | <b>ACK-02-L</b>               | C-SİSTEM için / For C-SYSTEM / FÜR C-SYSTEM<br>KNUX-L BASKI PABUCU / CLAMP / PRATZE   |
|                            | <b>ACK-03</b>                 | C-SİSTEM için / For C-SYSTEM / FÜR C-SYSTEM<br>154.91 DIŞ ÇAP ve DELİK İÇİ/EXTERNAL and INTERNAL/ AUBEN-DREHHALTER<br>Ø25-Ø32 / PABUCU / CLAMP / PRATZE   |
|                            | <b>ACK-04</b>                 | P-C-SİSTEM için / For P-C-SYSTEM / FÜR P-C-SYSTEM<br>CTFPR KARTUŞ BASKI PABUCU / CARTRIDGE CLAMP / PRATZE FÜR KASSETTE  |
|                            | <b>ACK-05</b>                 | P-C-SİSTEM için / For P-C-SYSTEM / FÜR P-C-SYSTEM<br>FREZELEME ve DIŞ VIDA AÇMA TAKIMLARINA GÖRE İLAVE BASKI PABUCU<br>ADDITIONAL LITTLE CLAMP for MILLING and THREADING CLAMP<br>KLEINE ZUSATZKLEMME FÜR FRÄSER UND GEWINDEWERKZEUGE |
|                            | <b>ACK-06</b>                 | C-SİSTEM için / For C-SYSTEM / FÜR C-SYSTEM<br>154.91 DELİK İÇİ / INTERNAL / INNEN Ø16-Ø20<br>BASKI PABUCU / CLAMP / PRATZE   |
|                            | <b>ACK-07</b>                 | C-SİSTEM için / For C-SYSTEM / FÜR C-SYSTEM<br>SERAMİK CNGN, SNGN, DNGN YEDEK TAKIMI SPARE PART SET of CERAMIC CNGN, SNGN,<br>DNGN<br>ERSATZTEILSATZ FÜR KERAMIK CNGN, SNGN, DNGN   |
|                            | <b>ACK-08</b>                 | C-SİSTEM için / For C-SYSTEM / FÜR C-SYSTEM<br>SERAMİK TNGN, YEDEK TAKIMI SPARE PART SET of CERAMIC TNGN<br>ERSATZTEILSATZ FÜR KERAMIK TNGN   |
|                            | <b>ACK-09</b>                 | P-SİSTEM için / For P-SYSTEM / FÜR P-SYSTEM<br>CNMG 16-19, SNMG 15-19 İLAVE BÜYÜK BASKI PABUCU ADDITIONAL BIG CLAMP<br>/ ZUSÄTZLICHE GROSSE KLEMMME   |
|                            | <b>ACK-10</b>                 | C-SİSTEM FREZELEME için / For C-SYSTEM MILLING<br>C-SYSTEM FÜR FRÄSER<br>SPKN 12, Ø50-Ø63 TPKN 16<br>BASKI PABUCU / CLAMP / PRATZE (M8x8)   |
|                            | <b>ACK-11</b>                 | C-SİSTEM FREZELEME için / For C-SYSTEM MILLING<br>C-SYSTEM FÜR FRÄSER<br>Ø80-Ø100 TPKN 16-TPKN 22, OFKR 07, HNM 09<br>BASKI PABUCU / CLAMP / PRATZE (M8x10)   |
|                            | <b>ACK-12</b>                 | C-SİSTEM için / For C-SYSTEM / FÜR C-SYSTEM<br>CTSPR KARTUŞ BASKI PABUCU / CARTRIDGE CLAMP  |
|                            | <b>ACK-15</b>                 | S-SİSTEM FREZELEME için / For S-SYSTEM MILLING<br>S-SYSTEM FÜR FRÄSER<br>RD.. 10-12 BASKI PABUCU / CLAMP / PRATZE   |
|                            | <b>ACK-19</b>                 | S-SİSTEM FREZELEME için / For S-SYSTEM MILLING<br>S-SYSTEM FÜR FRÄSER<br>WD0805D BASKI PABUCU / CLAMP / PRATZE  |
|                            | <b>ACK-21</b>                 | C-SİSTEM için / For C-SYSTEM / FÜR C-SYSTEM<br>SN.. 1204.. BASKI PABUCU / CLAMP / PRATZE  |
|                            | <b>ACK-23</b>                 | C-SİSTEM için / For C-SYSTEM / FÜR C-SYSTEM<br>SERAMİK DNGN 11, YEDEK TAKIMI SPARE PART SET of CERAMIC DNGN 11<br>ERSATZTEILSATZ FÜR KERAMIK DNGN 11  |
|                            | <b>ACK-24</b>                 | S-SİSTEM FREZELEME için / For S-SYSTEM MILLING<br>S-SYSTEM FÜR FRÄSER<br>XD0806D BASKI PABUCU / CLAMP / PRATZE  |
|                            | <b>ACK-26</b>                 | C-SİSTEM için / For C-SYSTEM / FÜR C-SYSTEM<br>XNMG 0806.. BASKI PABUCU / CLAMP / PRATZE  |
|                            | <b>ACK-27</b>                 | C-SİSTEM için / For C-SYSTEM / FÜR C-SYSTEM<br>RCGX 06 BASKI PABUCU / CLAMP / PRATZE  |
|                            | <b>ACK-28</b>                 | C-SİSTEM için / For C-SYSTEM / FÜR C-SYSTEM<br>RCGX 09 BASKI PABUCU / CLAMP / PRATZE  |
|                            | <b>ACK-29</b>                 | C-SİSTEM için / For C-SYSTEM / FÜR C-SYSTEM<br>RCGX 12 BASKI PABUCU / CLAMP / PRATZE  |

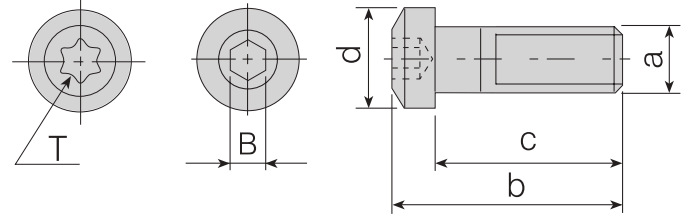

| Takım Kodu<br>Ordering Code<br>Bestell-Bezeichnung | BASKI PABUÇ VİDALARI / CLAMP SCREWS / SCHRAUBEN FÜR PRATZEN |      |      |      |      | Ürün Detayı / Product Detail / Produkt-Details  |
|--|---|------|------|------|------|---|
|  | a (M)   | b    | c    | d    | B(T) |   |
| AKV-01-M5X22                                       | M5x0.8  | 25   | 22   | 11   | 3    | T-SİSTEM için / For T-SYSTEM / FÜR T-SYSTEM<br>DNMG 11, WNMG 06, TNMG 16  |
| AKV-02-M6X22                                       | M6x1.0  | 25   | 22   | 11   | 3    | T-SİSTEM için / For T-SYSTEM / FÜR T-SYSTEM<br>CNMG 12, WNMG 08, TNMG 22, DNMG 15, SNMG 12, VNMG 16   |
|  |   |      |      |      |      | M-SİSTEM için / For M-SYSTEM / FÜR M-SYSTEM<br>TNMG 16, TNMG 22   |
| AKV-03-M6X22                                       | M6x1.0  | 24.5 | 22   | 10   | 3    | M-SİSTEM için / For M-SYSTEM / FÜR M-SYSTEM<br>WNMG 08  |
|  |   |      |      |      |      | KANAL KATERİ için / For EXTERNAL GROOVING<br>FÜR STECHWERKZEUGE<br>2mm Dış Çap Kanal Kater Vidası / External Grooving Tools Screw<br>2 mm Schraube für Außen-Stechwerkzeuge |
| AKV-04-M5X17                                       | M6x1.0  | 20   | 17   | 8.35 | 3    | M-SİSTEM için / For M-SYSTEM / FÜR M-SYSTEM<br>S20R MT-NR/L 16, S20R-S25S MWLNR/L 06, S25S MDUNR/L 11-Dış Çap / External / AUBEN MWLNR 06                                   |
| AKV-05-M6X10                                       | .....   | .... | ...  | ...  | .    | T-SİSTEM için / For T-SYSTEM / FÜR T-SYSTEM<br>Eski Ürün Vidası / Old Products Screws / Schraube für altes Produkt CNMG 16, SNMG 15   |
| AKV-05-M6X25                                       | M6x1.0  | 29.5 | 25   | 13.8 | 4    | T-SİSTEM için / For T-SYSTEM / FÜR T-SYSTEM<br>.....  |
| AKV-06-M6X20                                       | M6x1.0  | 26.5 | 20   | 10.6 | 4    | C-SİSTEM için / For C-SYSTEM / FÜR C-SYSTEM<br>KNUX 16  |
| AKV-07-M6X22                                       | M6x1.0  | 24   | 22   | 8.5  | 3    | C-SİSTEM için / For C-SYSTEM / FÜR C-SYSTEM<br>ADKT-154.91, AIKT-154.91-R/L-32  |
| AKV-10-M6X14                                       | M6x1.0  | 18   | 17   | 8.5  | 4    | C-SİSTEM için / For C-SYSTEM / FÜR C-SYSTEM<br>AIKT-154.91-R/L-16, AIKT-154.91-R/L-20, AIKT-154.91-R/L-25   |
| AKV-11-M8X29                                       | M8x1.25   | 34   | 29   | 11   | 4    | C-SİSTEM için / For C-SYSTEM / FÜR C-SYSTEM<br>TNGN 16, CNGN 12, DNGN 15, SNGN 12   |
| AKV-17-M5X15                                       | M5x0.8  | 18   | 15   | 8.5  | 3    | M-SİSTEM için / For M-SYSTEM / FÜR M-SYSTEM<br>S16P MWLNR/L 06  |
| AKV-19-M7X25                                       | M7x1.0  | 29   | 25   | 13   | 4    | T-SİSTEM için / For T-SYSTEM / FÜR T-SYSTEM<br>Yeni / New / Neu CNMG 16, SNMG 15  |
| AKV-20-M6X19                                       | M6x1.0  | 22   | 19.5 | 10   | 3    | M-SİSTEM için / For M-SYSTEM / FÜR M-SYSTEM<br>S25S MDUNR/L 15  |
| AKV-21-M6X18                                       | M6x1.0  | 18   | 16   | 8.5  | 3    | C-SİSTEM için / For C-SYSTEM / FÜR C-SYSTEM<br>AIKT-154.91-R/L-25   |
| AKV-23-M4X10                                       | M4x0.7  | 12   | 10   | 7.4  | 15   | KARTUŞ için / For CARTRIDGE / ДЛЯ КАРТРИДЖЕЙ<br>Montaj Vidası / Mounting Screw / Befestigungsschraube   |
| AKV-27-M6X20                                       | M6x1.0  | 22   | 19   | 10   | 3    | M-SİSTEM için / For M-SYSTEM / FÜR M-SYSTEM<br>S25S MWLNR/L 08  |
| AKV-30-M6X22                                       | M6x1.0  | 25   | 22   | 11   | 3    | T-SİSTEM için / For T-SYSTEM / FÜR T-SYSTEM<br>Baskı Pabucu / Wedge Clamp / Spannpratze   |
| AKV-33-M6X22                                       | M6x1.0  | 25   | 22.5 | 9.5  | 3    | T-SİSTEM için / For T-SYSTEM / FÜR T-SYSTEM<br>Baskı Pabucu / Wedge Clamp / Spannpratze   |
| AKV-39-M7X21                                       | M7x1.0  | 25.5 | 21   | 11.5 | 4    |   |

| Ürün Resmi<br>Product Picture<br>Produkt-Bild | SOĞUTMA NOZULU / COOLANT NOZZLE / KÜHLMITTELDÜSE |  |
|---|--|--|
|   | Ürün Kodu<br>Product Code / Code                 | Ürün Detayı / Product Detail / Produkt-Details   |
|   | AN-01  | SOĞUTMA NOZULU / Coolant Nozzle / KÜHLMITTELDÜSE |

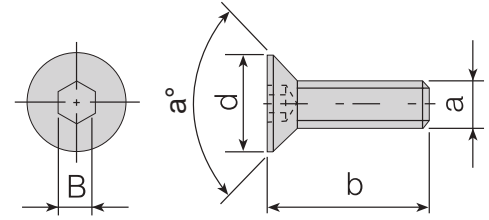

ALTLIK VIDALARI / SHIM SCREWS / SCHRAUBE FÜR UNTERLAGE

| Takım Kodu<br>Ordering Code<br>Bestell-Bezeichnung | a (M)  | b  | d   | B | a°  | Ürün Detayı / Product Detail / Produkt-Details   |
|--|--------|----|-----|---|-----|--|
| AAV-01-M3x10                                       | M3X0.5 | 10 | 5.9 | 2 | 90° | T-SİSTEM için / For T-SYSTEM / FÜR T-SYSTEM / WNMG 06, KNUX 16   |
| AAV-02-M5X12                                       | M5X0.8 | 12 | 7   | 3 | 56° | T-SİSTEM için / For T-SYSTEM / FÜR T-SYSTEM / CNMG 12, WNMG 08, TNMG 22, DNMG 15, SNMG 12                        |
| AAV-05-M6X15                                       | M6X1.0 | 15 | 9   | 4 | 60° | T-SİSTEM için / For T-SYSTEM / FÜR T-SYSTEM / CNMG 16, SNMG 15   |
| AKV-12-M5X12                                       | M5X0.8 | 12 | 7.8 | 3 | 90° | C-SİSTEM için / For C-SYSTEM / FÜR C-SYSTEM / CTSPR Baskı Pabuç Vidası / Clamp Screw / Зажимной винт             |
| AKV-16-M6X16                                       | M6X1.0 | 16 | 10  | 4 | 76° | C-SİSTEM için / For C-SYSTEM / FÜR C-SYSTEM / CTFPR 13CS 16 Baskı Pabuç Vidası / Clamp Screw / Зажимной винт     |
| AAV-13-M5X8  | M5X0.8 | 8  | 7   | 3 | 56° | T-SİSTEM için / For T-SYSTEM / FÜR T-SYSTEM / S25S TSKNR/L 12, S25S TCLNR/L 12, S25S TWLNR/L 08, S25S TDUNR/L 15 |
| AAV-14-M5X14                                       | M5X0.8 | 14 | 8.8 | 3 | 45° | ADCR için / For ADCR / FÜR ADCR / ADCR Montaj Vidası / Mounting Screw / ADCR BEFESTIGUNGSSCHRAUBE                |

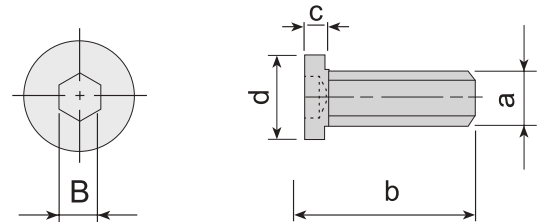

ALTLIK VIDALARI / SHIM SCREWS / SCHRAUBE FÜR UNTERLAGE

| Takım Kodu<br>Ordering Code<br>Bestell-Bezeichnung | a (M)  | b  | c   | d   | B | Ürün Detayı / Product Detail / Produkt-Details   |
|--|--------|----|-----|-----|---|--|
| AAV-03-M5X12                                       | M5X0.8 | 12 | 1.4 | 6   | 3 | T-SİSTEM için / For T-SYSTEM / FÜR T-SYSTEM / TNMG 16<br>C-SİSTEM için / For C-SYSTEM / FÜR C-SYSTEM / TNGN 16 |
| AAV-04-M5X12                                       | M5X0.8 | 12 | 1.2 | 6.5 | 3 | T-SİSTEM için / For T-SYSTEM / FÜR T-SYSTEM / VNMG 16, DNMG 11, CNMG 09  |
| AAV-09-M5X9  | M5X0.8 | 9  | 1.4 | 6   | 3 | T-SİSTEM için / For T-SYSTEM / FÜR T-SYSTEM / S25S TCLNR/L 09, S25S TDUNR/L 11, S25S TDQNR/L 11                |

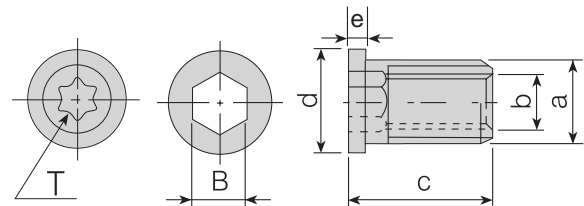

BUKSE VIDALAR / BUKSE SCREWS / SCHRAUBE FÜR UNTERLAGE

| Takım Kodu<br>Ordering Code<br>Bestell-Bezeichnung | a (M)   | b         | c    | d   | B(T) | e    | Ürün Detayı / Product Detail / Produkt-Details   |
|--|---------|-----------|------|-----|------|------|--|
| AAV-06-M3.5X11                                     | M5x0.5  | M3.5x0.6  | 11.3 | 6   | 3.5  | 1.2  | S-SİSTEM için / For S-SYSTEM / FÜR S-SYSTEM / CCMT 09, DCMT 11, VBMT 16, VCMT 16, TCMT 16, SCMT 09, 16 ER/L, 16 IR/L |
| AAV-07-M4.5X13                                     | M6X0.75 | M4.5X0.75 | 13   | 7.5 | 4.5  | 1.6  | S-SİSTEM için / For S-SYSTEM / FÜR S-SYSTEM / CCMT 12, SCMT 12, 22 ER/L, 22 IR/L                                     |
| AAV-08-M3.5X8                                      | M5X0.5  | M3.5x0.6  | 8    | 6   | 20   | 1.2  | S-SİSTEM için / For S-SYSTEM / FÜR S-SYSTEM / Ø25 DCMT 11, Ø25-Ø32 CCMT 09, Ø25 TCMT 16, S25S-S32T SVJBR/L 16,       |
| AAV-10-M4.5X8                                      | M6X0.75 | M4.5X0.75 | 8    | 7.5 | 4.5  | 1.05 | Ø25-Ø32 CCMT 12, Ø25-Ø32 SCMT 12, SSSDCN 1616 H12, SSSCR/L 1616 H12, SIR/L S25R 22                                   |
| AAV-16-M3.5X8                                      | M5X0.5  | M3.5x0.6  | 8    | 6   | 20   | 1.1  | S-SİSTEM için / For S-SYSTEM / FÜR S-SYSTEM / SEMT 13  |

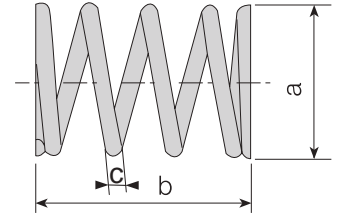
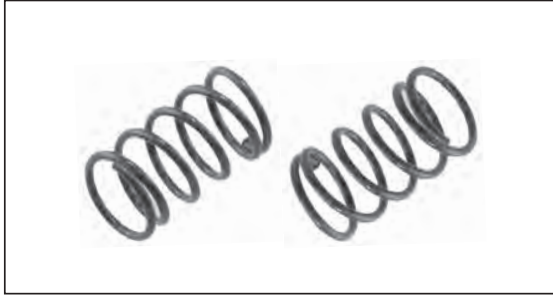

| BASKI YAYI / CLAMP SPRING / FEDER FÜR KLEMME       |     |      |     |  |         |      |
|--|-----|------|-----|--|---------|------|
| Takım Kodu<br>Ordering Code<br>Bestell-Bezeichnung | a   | b    | c   | Ürün Detayı / Product Detail / Produkt-Details |         |      |
|  |     |      |     | AKY-01   | 7.7     | 11.2 |
| AKY-02   | 8.5 | 13.5 | 0.7 | C-SİSTEM için / For C-SYSTEM / FÜR C-SYSTEM    | KNUX 16 |      |

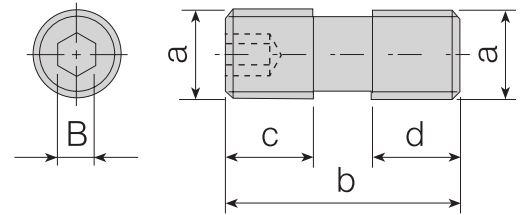

| BASKI PABUÇ VIDALARI / CLAMP SCREWS / SCHRAUBEN FÜR PRATZEN |         |    |     |     |     |   |                                    |
|---|---------|----|-----|-----|-----|---|------------------------------------|
| Takım Kodu<br>Ordering Code<br>Bestell-Bezeichnung          | a (M)   | b  | c   | d   | B   | Ürün Detayı / Product Detail / Produkt-Details                        |                                    |
|   |         |    |     |     |     | AKV-13-M8X1X16  | M8x1.0                             |
| AKV-14-M8X1X18  | M8x1.0  | 18 | 8   | 8   | 4   | C-SİSTEM FREZELEME için / MILLING For C- SYSTEM / FÜR C-SYSTEM        | Ø80-Ø100 TPKN 16, Ø63-Ø315 TPKN 22 |
| AKV-15-M8X1X20  | M8x1.0  | 20 | 8.5 | 8.5 | 4   | C-SİSTEM FREZELEME için / MILLING For C- SYSTEM / FÜR C-SYSTEM        | OFKR 07, HNMX 09                   |
| AKV-18-M5X14  | M5X0.8  | 15 | 5   | 6.8 | 2.5 | C-SİSTEM FREZELEME için / MILLING For C- SYSTEM / FÜR C-SYSTEM        | SN19                               |
| AKV-22-M8X1X14  | M8x1.0  | 14 | 6.8 | 4.8 | 4   | C-SİSTEM FREZELEME için / MILLING For C- SYSTEM / FÜR C-SYSTEM        | Ø50 TPKN 16                        |
| AKV-24-M6X1X18  | M6x1.0  | 18 | 7.5 | 7.5 | 3   | C-SİSTEM FREZELEME için / MILLING For C- SYSTEM / FÜR C-SYSTEM        | SN.. 1204                          |
| AKV-26-M6X0.75X20   | M6x0.75 | 20 | 8.5 | 8.5 | 3   | C-SİSTEM FREZELEME için / MILLING For C- SYSTEM / FÜR C-SYSTEM        | AFM45C-XN0806                      |
| AKV-28-M10x1.5x43   | M10x1.5 | 43 | 18  | 18  | 5   | WNMU 0907.. Ø50 MONTAJ VIDASI / MOUNTING SCREW / BEFESTIGUNGSSCHRAUBE | WNMU 0907.. Ø50                    |



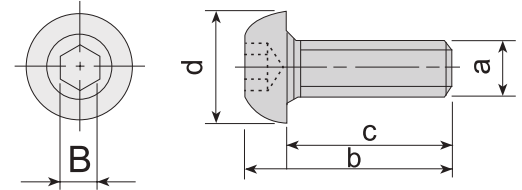

KANAL KATER ve MANTAR VİDALAR / GROOVING TOOL and CLAMP SCREWS / KLEMMSCHRAUBEN

| Takım Kodu<br>Ordering Code<br>Bestell-Bezeichnung | a (M)   | b    | c  | d    | B | Ürün Detayı / Product Detail / Produkt-Details   |
|--|---------|------|----|------|---|--|
| 1904-M8X1X20                                       | M8X1.0  | 25.9 | 20 | 11.3 | 4 | S-SİSTEM için / For S-SYSTEM / FÜR S-SYSTEM<br>RCMT 32 Sıkma Vidası / Clamp Screw / Klemmschraube  |
| 2004-M8X1X20                                       | M8X1.0  | 25.9 | 20 | 11.4 | 4 | KANAL KATERİ için / For EXTERNAL GROOVING / FÜR TMNG-16, TMNG-22 BOHRSTANGE<br>Kanal Kater Vidası / External Grooving Tools Screw / SCHRAUBEN FÜR STECHHALTER              |
| 2004-M8X20   | M8X1.25 | 30   | 25 | 25   | 4 | KANAL KATERİ için / For EXTERNAL GROOVING / FÜR TMNG-16, TMNG-22 BOHRSTANGE<br>Eski Kanal Kater Vidası / Old External Grooving Tools Screw Alte / Schraube für Stechhalter |
| AKV-08-M6X12                                       | M6x1.0  | 17   | 12 | 14.3 | 4 | C-SİSTEM FREZELEME için / MILLING For C-SYSTEM / C-SYSTEM FÜR FRÄSER<br>Baskı ve Sıkma Vidası, Mantar Vida / Clamp Screw / Klemmschraube                                   |
| AKV-09-M8X18                                       | M8X1.0  | 24   | 18 | 17.2 | 5 | C-SİSTEM FREZELEME için / MILLING For C-SYSTEM / C-SYSTEM FÜR FRÄSER<br>Baskı ve Sıkma Vidası, Mantar Vida / Clamp Screw / Klemmschraube                                   |

LEVYELER / LEVERS / KNIEHEBEL

| Ürün Resmi<br>Product Picture<br>Produkt-Bild | Ürün Kodu<br>Product Code / Code | Ürün Detayı / Product Detail / Produkt-Details  |
|---|----------------------------------|---|
|   | APL-01                           | P-SİSTEM için / For P-SYSTEM / FÜR P-SYSTEM<br>CNMG 09, DNMG 11, SNMG 09, TNMG 16, WNMG 06 LEVYESİ / LEVER / KNIEHEBE |
|   | APL-02                           | P-SİSTEM için / For P-SYSTEM / FÜR P-SYSTEM<br>CNMG 12, SNMG 12, TNMG 22, WNMG 08 LEVYESİ / LEVER / KNIEHEBE          |
|   | APL-03                           | P-SİSTEM için / For P-SYSTEM / FÜR P-SYSTEM<br>DNMG 15 LEVYESİ / LEVER / KNIEHEBE                                     |
|   | APL-04                           | P-SİSTEM için / For P-SYSTEM / FÜR P-SYSTEM<br>CNMG 16, SNMG 15 LEVYESİ / LEVER / KNIEHEBEL                           |
|   | APL-05                           | P-SİSTEM için / For P-SYSTEM / FÜR P-SYSTEM<br>CNMG 19, SNMG 19 LEVYESİ / LEVER / KNIEHEBEL                           |
|   | APL-06                           | P-SİSTEM için / For P-SYSTEM / FÜR P-SYSTEM<br>CNMG 25, SNMG 25 LEVYESİ / LEVER / KNIEHEBEL                           |
|   | APL-07                           | P-SİSTEM için / For P-SYSTEM / FÜR P-SYSTEM<br>S16P PCLNR/L 09 LEVYESİ / LEVER / KNIEHEBEL                            |
|   | APL-08                           | P-SİSTEM için / For P-SYSTEM / FÜR P-SYSTEM<br>S16P PTUNR/L 16 LEVYESİ / LEVER / KNIEHEBEL                            |
|   | APL-11                           | P-SİSTEM için / For P-SYSTEM / FÜR P-SYSTEM<br>TNMG 11 LEVYESİ / LEVER / KNIEHEBEL                                    |

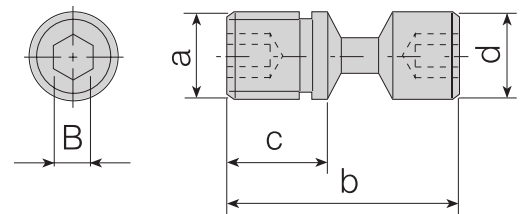

LEVYE VİDALARI / LEVER SCREWS / SCHRAUBEN FÜR KNIEHEBEL

| Takım Kodu<br>Ordering Code<br>Bestell-Bezeichnung | a (M)   | b    | c   | d    | B   | Ürün Detayı / Product Detail / Produkt-Details   |
|--|---------|------|-----|------|-----|--|
| ALV-01-M6X14                                       | M6x1.0  | 14   | 10  | 5.85 | 2.5 | P-SİSTEM için / For P-SYSTEM / FÜR P-SYSTEM<br>S20R PCLNR/L 09, S20R PDUNR/L 11, S20R PDQNR/L 11, S20R PWNLR/L 06, S20R PTUNR/L 16 |
| ALV-02-M6X17                                       | M6x1.0  | 17   | 10  | 5.85 | 2.5 | P-SİSTEM için / For P-SYSTEM / FÜR P-SYSTEM<br>CNMG 09, DNMG 11, SNMG 09, TNMG 16, WNMG 06   |
| ALV-03-M8X19                                       | M8X1.0  | 19.8 | 11  | 7.9  | 3   | P-SİSTEM için / For P-SYSTEM / FÜR P-SYSTEM<br>CNMG 12, SNMG 12, TNMG 22, WNMG 08, DNMG 15   |
| ALV-04-M8X22                                       | M8X1.0  | 21.5 | 13  | 7.75 | 3   | P-SİSTEM için / For P-SYSTEM / FÜR P-SYSTEM<br>CNMG 16, SNMG 15  |
| ALV-05-M10X27                                      | M10X1.0 | 27.5 | 15  | 9.9  | 4   | P-SİSTEM için / For P-SYSTEM / FÜR P-SYSTEM<br>CNMG 19, SNMG 19  |
| ALV-06-M12X36                                      | M12X1.0 | 36   | 20  | 12   | 5   | P-SİSTEM için / For P-SYSTEM / FÜR P-SYSTEM<br>CNMG 25, SNMG 25  |
| ALV-07-M6X13                                       | M6X1.0  | 12.6 | 6.5 | 5.9  | 2.5 | P-SİSTEM için / For P-SYSTEM / FÜR P-SYSTEM<br>S16P PCLNR/L 09, S16P PTUNR/L 16  |
| ALV-08-M8X16                                       | M8X1.0  | 16   | 10  | 7.9  | 3   | P-SİSTEM için / For P-SYSTEM / FÜR P-SYSTEM<br>S25S PCLNR/L 12, S25S PDUNR/L 15, S25S PSKNR/L 12                                   |
| ALV-10-M5X10                                       | M5x0.8  | 10   | 4.6 | 4.9  | 2.5 | P-SİSTEM için / For P-SYSTEM / FÜR P-SYSTEM<br>TNMG 11   |

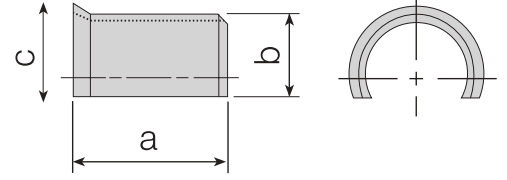

ALTLIK YAYLARI / SHIM SPRINGS / BEFESTIGUNGSFEDER

| Takım Kodu<br>Ordering Code<br>Bestell-Bezeichnung | a   | b   | c    | Ürün Detayı / Product Detail / Produkt-Details |  |
|--|-----|-----|------|--|--|
|  |     |     |      | Ürün Detayı / Product Detail / Produkt-Details | Ürün Detayı / Product Detail / Produkt-Details |
| AA-Y-01  | 5.6 | 4.9 | 6    | P-SİSTEM için / For P-SYSTEM / FÜR P-SYSTEM    | CNMG 09 ,DNMG 11, SNMG 09, TNMG 16, WNMG 06    |
| AA-Y-02  | 6   | 6.9 | 7.9  | P-SİSTEM için / For P-SYSTEM / FÜR P-SYSTEM    | CNMG 12, SNMG 12, TNMG 22, WNMG 08, DNMG 15    |
| AA-Y-03  | 8.9 | 8   | 9.5  | P-SİSTEM için / For P-SYSTEM / FÜR P-SYSTEM    | CNMG 16, SNMG 15                               |
| AA-Y-04  | 11  | 9.8 | 10.7 | P-SİSTEM için / For P-SYSTEM / FÜR P-SYSTEM    | CNMG 19, SNMG 19                               |
| AA-Y-05  | 12  | 13  | 15   | P-SİSTEM için / For P-SYSTEM / FÜR P-SYSTEM    | CNMG 25, SNMG 25                               |
| AA-Y-07  | 5.6 | 4.9 | 6    | P-SİSTEM için / For P-SYSTEM / FÜR P-SYSTEM    | CNMG 09, TNMG 16                               |

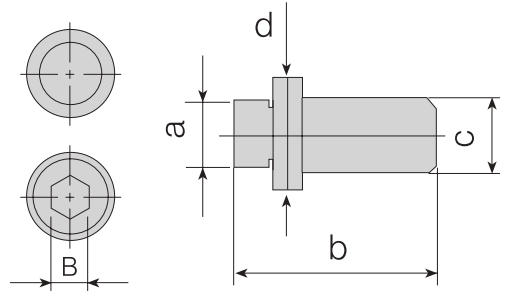

PİMLER / PINS / STIFT

| Takım Kodu<br>Ordering Code<br>Bestell-Bezeichnung | a    | b    | c    | d    | B | Ürün Detayı / Product Detail / Produkt-Details |   |
|--|------|------|------|------|---|--|---|
|  |      |      |      |      |   | Ürün Detayı / Product Detail / Produkt-Details | Ürün Detayı / Product Detail / Produkt-Details  |
| APM-01   | 3.55 | 18   | 5    | 6    | - | M-SİSTEM için / For M-SYSTEM / FÜR M-SYSTEMM   | Delik İçi / Internal / Intern Ø32-Ø40 TNMG 16<br>Dış Çap / External / Externe TNMG 16 |
| APM-02   | 5    | 18   | 6    | 7.3  | - | M-SİSTEM için / For M-SYSTEM / FÜR M-SYSTEMM   | TNMG 22, WNMG 08  |
| APM-03   | 3.5  | 12   | 5    | 6.5  | - | M-SİSTEM için / For M-SYSTEM / FÜR M-SYSTEMM   | S20R MTFNR/L 16, S20R MT-NR/L 16, S20R MTUNR/L 16, S20R MTQNR/L 16, S20R MDUNR/L 11   |
| APM-04   | 5    | 15   | 6    | 7.3  | - | M-SİSTEM için / For M-SYSTEM / FÜR M-SYSTEMM   | S32T MCLNR/L 12, DNMG 15, S25S MWLNR/L 08   |
| APM-05   | 4.50 | 11.5 | 6.5  | 6.5  | 3 | M-SİSTEM için / For M-SYSTEM / FÜR M-SYSTEMM   | MSYNR 11.5CS 12 Kartuş için / for Cartridge / FÜR KASSETTE                            |
| APM-06   | 3    | 15.7 | -    | -    | - | C-SİSTEM için / For C-SYSTEM / FÜR C-SYSTEM    | 154.91  |
| APM-07   | 3.5  | 11.5 | 6.5  | 6.5  | 3 | M-SİSTEM için / For M-SYSTEM / FÜR M-SYSTEMM   | S20R ET-NR 16   |
| APM-08   | 3.5  | 12   | 5    | 5.4  | - | M-SİSTEM için / For M-SYSTEM / FÜR M-SYSTEMM   | S25S MWLNR/L 06, Dış Çap / External / Externe   |
| APM-09   | 3.5  | 10   | 5    | 5.4  | - | M-SİSTEM için / For M-SYSTEM / FÜR M-SYSTEMM   | S16P MWLNR/L 06   |
| APM-10   | 3.5  | 11   | 5    | 5.4  | - | M-SİSTEM için / For M-SYSTEM / FÜR M-SYSTEMM   | S20R MWLNR/L 06   |
| APM-11   | 3.5  | 11   | 5    | 6.5  | - | M-SİSTEM için / For M-SYSTEM / FÜR M-SYSTEMM   | S20R MTQNR/L 16   |
| APM-12   | 5    | 12   | 6    | 7.3  | - | M-SİSTEM için / For M-SYSTEM / FÜR M-SYSTEMM   | S20R MCLNR/L 12, S25S MCLNR/L 12-Z  |
| APM-13   | 5    | 14   | 6    | 7.3  | - | M-SİSTEM için / For M-SYSTEM / FÜR M-SYSTEMM   | S25S MCLNR/L 12   |
| APM-14   | 3.55 | 15   | 5    | 6    | - | M-SİSTEM için / For M-SYSTEM / FÜR M-SYSTEMM   | S25S MTFNR/L 16, S25S MT-NR/L 16, S25S MTUNR/L 16, S25S MTQNR/L 16                    |
| APM-15   | 4.40 | 16   | 6.40 | 6.40 | 3 | M-SİSTEM için / For M-SYSTEM / FÜR M-SYSTEMM   | MSYNR 16CS 12 Kartuş için / for Cartridge / FÜR KASSETTE                              |

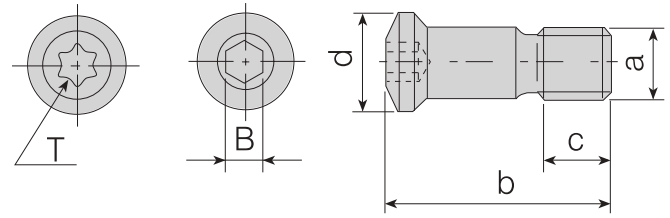

KÜRESEL FİNİŞ VİDALARI / BALL NOSE SCREWS / SCHRAUBEN FÜR KUGELKOPFFRÄSER

| Takım Kodu<br>Ordering Code<br>Bestell-Bezeichnung | a (M)    | b    | c   | d    | B(T) | Ürün Detayı / Product Detail / Produkt-Details                                  |
|--|----------|------|-----|------|------|---|
| 1208-M3x7  | M3x0.5   | 6.9  | 2.7 | 4.1  | 8    | KÜRESEL FREZE VİDASI / BALL NOSE SCREW / SCHRAUBE FÜR KUGELFRÄSER P3208         |
| 1215-M4X0.5X9                                      | M4X0.5   | 8.6  | 3.2 | 5.75 | 15   | KÜRESEL FREZE VİDASI / BALL NOSE SCREW / SCHRAUBE FÜR KUGELFRÄSER P3210-ROHX 12 |
| 1220-M5X0.5X9                                      | M5X0.5   | 9.6  | 3.4 | 6.8  | 20   | KÜRESEL FREZE VİDASI / BALL NOSE SCREW / SCHRAUBE FÜR KUGELFRÄSER P3212         |
| 1220-M5X0.5X12                                     | M5X0.5   | 12.9 | 4.4 | 7.4  | 20   | KÜRESEL FREZE VİDASI / BALL NOSE SCREW / SCHRAUBE FÜR KUGELFRÄSER P3216-ROHX 16 |
| 1220-M5X0.5X15                                     | M5X0.5   | 16.4 | 6   | 7.8  | 20   | KÜRESEL FREZE VİDASI / BALL NOSE SCREW / SCHRAUBE FÜR KUGELFRÄSER P3220-ROHX 20 |
| 1220-M6X0.75X20                                    | M6X0.75  | 20   | 6   | 9.4  | 20   | KÜRESEL FREZE VİDASI / BALL NOSE SCREW / SCHRAUBE FÜR KUGELFRÄSER P3225         |
| 1204-M8X0.75X26                                    | M8X0.75  | 26   | 7.5 | 12   | 4    | KÜRESEL FREZE VİDASI / BALL NOSE SCREW / SCHRAUBE FÜR KUGELFRÄSER P3232         |
| 1210-M3.5X9.6                                      | M3.5X0.6 | 9.6  | 4   | 4.7  | 10   | KÜRESEL FREZE VİDASI / BALL NOSE SCREW / SCHRAUBE FÜR KUGELFRÄSER BNM 12        |
| 1215-M4X13.5                                       | M4X0.7   | 13.5 | 5   | 5.8  | 15   | KÜRESEL FREZE VİDASI / BALL NOSE SCREW / SCHRAUBE FÜR KUGELFRÄSER BNM 16        |

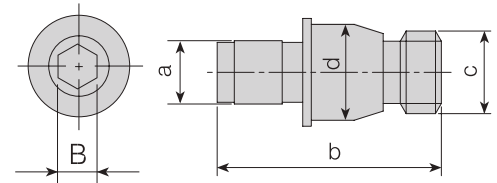
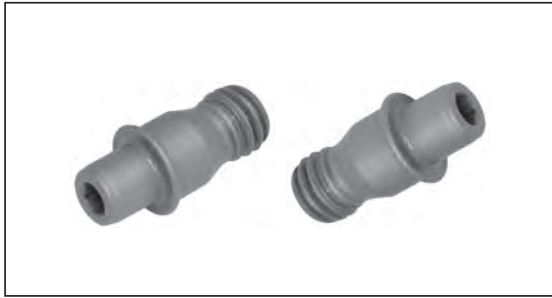

EKSANTRİK VİDA / ECCENTRIC SCREW / EXZENTERSCHRAUBEN

| Takım Kodu<br>Ordering Code<br>Bestell-Bezeichnung | a    | b  | c      | d   | B   | Ürün Detayı / Product Detail / Produkt-Details  |
|--|------|----|--------|-----|-----|---|
| AEV-01-M6x16                                       | 4.85 | 16 | M6x1.0 | 6.5 | 2.5 | Eksantrik Vida / Eccentric Screw / EXZENTERSCHRAUBEN PSDNN Kartuş için / for Cartridge / FÜR KASSETTE |

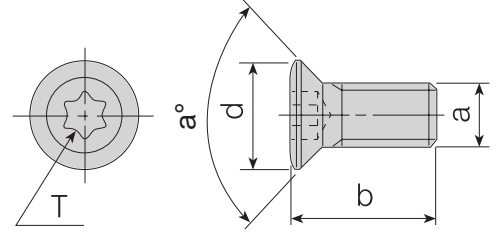

TORK VİDALARI / TORX SCREWS / TORX-SCHRAUBEN

| Takım Kodu<br>Ordering Code<br>Bestell-Bezeichnung | a (M)     | b    | T  | d    | a° | Ürün Detayı / Product Detail / Produkt-Details |   |
|--|-----------|------|----|------|----|--|---|
| 4006-M1.6x3.2                                      | M1.6X0.35 | 3.2  | 6  | 2.5  | 60 | S-SİSTEM için / For S-SYSTEM / FÜR S-SYSTEM    | TORK VİDA / TORX SCREW / TORX-SCHRAUBEN |
| 3006-M1.8x4  | M1.8X0.35 | 4    | 6  | 2.45 | 60 | S-SİSTEM için / For S-SYSTEM / FÜR S-SYSTEM    | TORK VİDA / TORX SCREW / TORX-SCHRAUBEN |
| 3006-M2x3.1  | M2X0.4    | 3.1  | 6  | 2.7  | 60 | S-SİSTEM için / For S-SYSTEM / FÜR S-SYSTEM    | TORK VİDA / TORX SCREW / TORX-SCHRAUBEN |
| 3006-M2x3.3  | M2X0.4    | 3.3  | 6  | 2.7  | 60 | S-SİSTEM için / For S-SYSTEM / FÜR S-SYSTEM    | TORK VİDA / TORX SCREW / TORX-SCHRAUBEN |
| 3006-M2X3.6  | M2X0.4    | 3.6  | 6  | 2.7  | 60 | S-SİSTEM için / For S-SYSTEM / FÜR S-SYSTEM    | TORK VİDA / TORX SCREW / TORX-SCHRAUBEN |
| 3006-M2x4  | M2X0.4    | 4.3  | 6  | 2.7  | 60 | S-SİSTEM için / For S-SYSTEM / FÜR S-SYSTEM    | TORK VİDA / TORX SCREW / TORX-SCHRAUBEN |
| 4006-M2x5  | M2X0.4    | 5    | 6  | 3    | 55 | S-SİSTEM için / For S-SYSTEM / FÜR S-SYSTEM    | TORK VİDA / TORX SCREW / TORX-SCHRAUBEN |
| 3007-M2.2x4.6                                      | M2.2X0.45 | 4.6  | 7  | 3.15 | 60 | S-SİSTEM için / For S-SYSTEM / FÜR S-SYSTEM    | TORK VİDA / TORX SCREW / TORX-SCHRAUBEN |
| 4006-M2.2x5  | M2.2X0.45 | 5    | 6  | 2.8  | 55 | S-SİSTEM için / For S-SYSTEM / FÜR S-SYSTEM    | TORK VİDA / TORX SCREW / TORX-SCHRAUBEN |
| 1008-M2.5x5  | M2.5X0.45 | 5.5  | 8  | 3.5  | 45 | S-SİSTEM için / For S-SYSTEM / FÜR S-SYSTEM    | TORK VİDA / TORX SCREW / TORX-SCHRAUBEN |
| 1008-M2.5x7  | M2.5X0.45 | 7    | 8  | 3.6  | 45 | S-SİSTEM için / For S-SYSTEM / FÜR S-SYSTEM    | TORK VİDA / TORX SCREW / TORX-SCHRAUBEN |
| 1108-M2.5x6  | M2.5X0.45 | 6    | 8  | 3.9  | R  | S-SİSTEM için / For S-SYSTEM / FÜR S-SYSTEM    | TORK VİDA / TORX SCREW / TORX-SCHRAUBEN |
| 3008-M2.5x5  | M2.5X0.45 | 5    | 8  | 3.5  | 60 | S-SİSTEM için / For S-SYSTEM / FÜR S-SYSTEM    | TORK VİDA / TORX SCREW / TORX-SCHRAUBEN |
| 3008-M2.5x6  | M2.5X0.45 | 6    | 8  | 3.5  | 60 | S-SİSTEM için / For S-SYSTEM / FÜR S-SYSTEM    | TORK VİDA / TORX SCREW / TORX-SCHRAUBEN |
| 3008-M2.5X8  | M2.5X0.45 | 8    | 8  | 3.5  | 50 | S-SİSTEM için / For S-SYSTEM / FÜR S-SYSTEM    | TORK VİDA / TORX SCREW / TORX-SCHRAUBEN |
| 4008-M2.5x4  | M2.5X0.45 | 4    | 8  | 3.5  | 45 | S-SİSTEM için / For S-SYSTEM / FÜR S-SYSTEM    | TORK VİDA / TORX SCREW / TORX-SCHRAUBEN |
| 4008-M2.5x4.5                                      | M2.5X0.45 | 4.5  | 8  | 3.5  | 45 | S-SİSTEM için / For S-SYSTEM / FÜR S-SYSTEM    | TORK VİDA / TORX SCREW / TORX-SCHRAUBEN |
| 4008-M2.5x6  | M2.5X0.45 | 5.8  | 8  | 3.5  | 45 | S-SİSTEM için / For S-SYSTEM / FÜR S-SYSTEM    | TORK VİDA / TORX SCREW / TORX-SCHRAUBEN |
| 4008-M2.5x6.5                                      | M2.5X0.45 | 6.5  | 8  | 4    | 60 | S-SİSTEM için / For S-SYSTEM / FÜR S-SYSTEM    | TORK VİDA / TORX SCREW / TORX-SCHRAUBEN |
| 4108-M2.5x6.5                                      | M2.5X0.45 | 6.5  | 8  | 3.5  | 50 | S-SİSTEM için / For S-SYSTEM / FÜR S-SYSTEM    | TORK VİDA / TORX SCREW / TORX-SCHRAUBEN |
| 4108-M2.5x8  | M2.5X0.45 | 8    | 8  | 3.5  | 50 | S-SİSTEM için / For S-SYSTEM / FÜR S-SYSTEM    | TORK VİDA / TORX SCREW / TORX-SCHRAUBEN |
| 1008-M3x6  | M3X0.5    | 6    | 8  | 4    | 60 | S-SİSTEM için / For S-SYSTEM / FÜR S-SYSTEM    | TORK VİDA / TORX SCREW / TORX-SCHRAUBEN |
| 1008-M3x8  | M3X0.5    | 8    | 8  | 3.9  | 60 | S-SİSTEM için / For S-SYSTEM / FÜR S-SYSTEM    | TORK VİDA / TORX SCREW / TORX-SCHRAUBEN |
| 1108-M3x6.8  | M3X0.5    | 6.8  | 8  | 4    | 60 | S-SİSTEM için / For S-SYSTEM / FÜR S-SYSTEM    | TORK VİDA / TORX SCREW / TORX-SCHRAUBEN |
| 3008-M3x6  | M3X0.5    | 6    | 8  | 4    | 45 | S-SİSTEM için / For S-SYSTEM / FÜR S-SYSTEM    | TORK VİDA / TORX SCREW / TORX-SCHRAUBEN |
| 3008-M3x7  | M3X0.5    | 7    | 8  | 4    | 55 | S-SİSTEM için / For S-SYSTEM / FÜR S-SYSTEM    | TORK VİDA / TORX SCREW / TORX-SCHRAUBEN |
| 3008-M3x8  | M3X0.5    | 8    | 8  | 4    | 45 | S-SİSTEM için / For S-SYSTEM / FÜR S-SYSTEM    | TORK VİDA / TORX SCREW / TORX-SCHRAUBEN |
| 3108-M3x6  | M3X0.5    | 6    | 8  | 3.8  | 60 | S-SİSTEM için / For S-SYSTEM / FÜR S-SYSTEM    | TORK VİDA / TORX SCREW / TORX-SCHRAUBEN |
| 4008-M3x8  | M3X0.5    | 8    | 8  | 4    | 60 | S-SİSTEM için / For S-SYSTEM / FÜR S-SYSTEM    | TORK VİDA / TORX SCREW / TORX-SCHRAUBEN |
| 4010-M3x6  | M3X0.5    | 6    | 10 | 4.2  | 45 | S-SİSTEM için / For S-SYSTEM / FÜR S-SYSTEM    | TORK VİDA / TORX SCREW / TORX-SCHRAUBEN |
| 4010-M3x8  | M3X0.5    | 8    | 10 | 4.2  | 45 | S-SİSTEM için / For S-SYSTEM / FÜR S-SYSTEM    | TORK VİDA / TORX SCREW / TORX-SCHRAUBEN |
| 1015-M3.5x9  | M3.5X0.6  | 9    | 15 | 5.3  | 60 | S-SİSTEM için / For S-SYSTEM / FÜR S-SYSTEM    | TORK VİDA / TORX SCREW / TORX-SCHRAUBEN |
| 1015-M3.5x11                                       | M3.5X0.6  | 11.1 | 15 | 5.3  | 60 | S-SİSTEM için / For S-SYSTEM / FÜR S-SYSTEM    | TORK VİDA / TORX SCREW / TORX-SCHRAUBEN |
| 1015-M3.5x14                                       | M3.5X0.6  | 14   | 15 | 5.3  | 66 | S-SİSTEM için / For S-SYSTEM / FÜR S-SYSTEM    | TORK VİDA / TORX SCREW / TORX-SCHRAUBEN |
| 1015-M3.5x16                                       | M3.5X0.6  | 16   | 15 | 5.3  | 55 | S-SİSTEM için / For S-SYSTEM / FÜR S-SYSTEM    | TORK VİDA / TORX SCREW / TORX-SCHRAUBEN |
| 1315-M3.5x11                                       | M3.5X0.6  | 10.6 | 15 | 7.9  | -  | S-SİSTEM için / For S-SYSTEM / FÜR S-SYSTEM    | TORK VİDA / TORX SCREW / TORX-SCHRAUBEN |
| 1510-M3.5x7  | M3.5X0.6  | 7.1  | 10 | 5.1  | 55 | S-SİSTEM için / For S-SYSTEM / FÜR S-SYSTEM    | TORK VİDA / TORX SCREW / TORX-SCHRAUBEN |
| 1510-M3.5x9  | M3.5X0.6  | 9.1  | 10 | 5    | 55 | S-SİSTEM için / For S-SYSTEM / FÜR S-SYSTEM    | TORK VİDA / TORX SCREW / TORX-SCHRAUBEN |
| 1615-M3.5x10                                       | M3.5X0.6  | 10   | 15 | 5.8  | 60 | S-SİSTEM için / For S-SYSTEM / FÜR S-SYSTEM    | TORK VİDA / TORX SCREW / TORX-SCHRAUBEN |
| 1615-M3.5x11                                       | M3.5X0.6  | 11   | 15 | 5.8  | 60 | S-SİSTEM için / For S-SYSTEM / FÜR S-SYSTEM    | TORK VİDA / TORX SCREW / TORX-SCHRAUBEN |
| 1615-M3.5x15                                       | M3.5X0.6  | 15   | 15 | 5.8  | 60 | S-SİSTEM için / For S-SYSTEM / FÜR S-SYSTEM    | TORK VİDA / TORX SCREW / TORX-SCHRAUBEN |
| 3010-M3.5x7  | M3.5X0.6  | 7    | 10 | 5    | 55 | S-SİSTEM için / For S-SYSTEM / FÜR S-SYSTEM    | TORK VİDA / TORX SCREW / TORX-SCHRAUBEN |
| 3010-M3.5x9  | M3.5X0.6  | 9    | 10 | 5    | 55 | S-SİSTEM için / For S-SYSTEM / FÜR S-SYSTEM    | TORK VİDA / TORX SCREW / TORX-SCHRAUBEN |
| 3015-M3.5x9  | M3.5X0.6  | 8.8  | 15 | 5.4  | 60 | S-SİSTEM için / For S-SYSTEM / FÜR S-SYSTEM    | TORK VİDA / TORX SCREW / TORX-SCHRAUBEN |
| 4015-M3.5x8  | M3.5X0.6  | 7.9  | 15 | 5.3  | 55 | S-SİSTEM için / For S-SYSTEM / FÜR S-SYSTEM    | TORK VİDA / TORX SCREW / TORX-SCHRAUBEN |
| 4015-M3.5x9  | M3.5X0.6  | 8.7  | 15 | 5.3  | 60 | S-SİSTEM için / For S-SYSTEM / FÜR S-SYSTEM    | TORK VİDA / TORX SCREW / TORX-SCHRAUBEN |
| 4015-M3.5x10                                       | M3.5X0.6  | 9.8  | 15 | 5.3  | 60 | S-SİSTEM için / For S-SYSTEM / FÜR S-SYSTEM    | TORK VİDA / TORX SCREW / TORX-SCHRAUBEN |

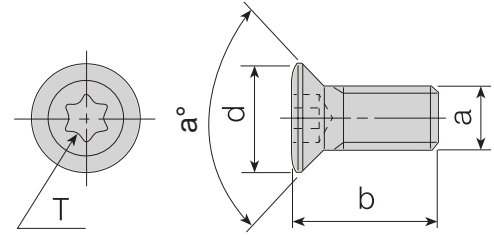

TORK VİDALARI / TORX SCREWS / TORX-SCHRAUBEN

| Takım Kodu<br>Ordering Code<br>Bestell-Bezeichnung | a (M)     | b    | T  | d    | a° | Ürün Detayı / Product Detail / Produkt-Detaİls |   |
|--|-----------|------|----|------|----|--|---|
| 4015-M3.5x11                                       | M3.5X0.6  | 10.7 | 15 | 5.3  | 60 | S-SİSTEM için / For S-SYSTEM / FÜR S-SYSTEM    | TORK VİDA / TORX SCREW / TORX-SCHRAUBEN |
| 4015-M3.5x12                                       | M3.5X0.6  | 12   | 15 | 5.3  | 60 | S-SİSTEM için / For S-SYSTEM / FÜR S-SYSTEM    | TORK VİDA / TORX SCREW / TORX-SCHRAUBEN |
| 4015-M3.5x14                                       | M3.5X0.6  | 13.7 | 15 | 5.3  | 60 | S-SİSTEM için / For S-SYSTEM / FÜR S-SYSTEM    | TORK VİDA / TORX SCREW / TORX-SCHRAUBEN |
| 1015-M4x8  | M4X0.7    | 8    | 15 | 6.8  | R  | S-SİSTEM için / For S-SYSTEM / FÜR S-SYSTEM    | TORK VİDA / TORX SCREW / TORX-SCHRAUBEN |
| 1015-M4x9  | M4X0.7    | 9    | 15 | 6.8  | R  | S-SİSTEM için / For S-SYSTEM / FÜR S-SYSTEM    | TORK VİDA / TORX SCREW / TORX-SCHRAUBEN |
| 1515-M4x9  | M4X0.7    | 9    | 15 | 5.7  | 50 | S-SİSTEM için / For S-SYSTEM / FÜR S-SYSTEM    | TORK VİDA / TORX SCREW / TORX-SCHRAUBEN |
| 1015-M4x11   | M4X0.7    | 10.8 | 15 | 6.8  | R  | S-SİSTEM için / For S-SYSTEM / FÜR S-SYSTEM    | TORK VİDA / TORX SCREW / TORX-SCHRAUBEN |
| 1115-M4x10   | M4X0.7    | 10   | 15 | 5.9  | R  | S-SİSTEM için / For S-SYSTEM / FÜR S-SYSTEM    | TORK VİDA / TORX SCREW / TORX-SCHRAUBEN |
| 1315-M4x11   | M4X0.7    | 11.1 | 15 | 5    | 45 | S-SİSTEM için / For S-SYSTEM / FÜR S-SYSTEM    | TORK VİDA / TORX SCREW / TORX-SCHRAUBEN |
| 1415-M4x11   | M4X0.7    | 11   | 15 | 5.6  | 50 | S-SİSTEM için / For S-SYSTEM / FÜR S-SYSTEM    | TORK VİDA / TORX SCREW / TORX-SCHRAUBEN |
| 1515-M4x11   | M4X0.7    | 11.1 | 15 | 5.6  | 50 | S-SİSTEM için / For S-SYSTEM / FÜR S-SYSTEM    | TORK VİDA / TORX SCREW / TORX-SCHRAUBEN |
| 1615-M4x11   | M4X0.7    | 11.1 | 15 | 6    | 50 | S-SİSTEM için / For S-SYSTEM / FÜR S-SYSTEM    | TORK VİDA / TORX SCREW / TORX-SCHRAUBEN |
| 3015-M4x9  | M4X0.7    | 9    | 15 | 5.6  | 50 | S-SİSTEM için / For S-SYSTEM / FÜR S-SYSTEM    | TORK VİDA / TORX SCREW / TORX-SCHRAUBEN |
| 3015-M4x11   | M4X0.7    | 11   | 15 | 5.6  | 50 | S-SİSTEM için / For S-SYSTEM / FÜR S-SYSTEM    | TORK VİDA / TORX SCREW / TORX-SCHRAUBEN |
| 4015-M4X8  | M4X0.7    | 8    | 15 | 5.6  | 50 | S-SİSTEM için / For S-SYSTEM / FÜR S-SYSTEM    | TORK VİDA / TORX SCREW / TORX-SCHRAUBEN |
| 4015-M4x9  | M4X0.7    | 9    | 15 | 5.6  | 50 | S-SİSTEM için / For S-SYSTEM / FÜR S-SYSTEM    | TORK VİDA / TORX SCREW / TORX-SCHRAUBEN |
| 4015-M4x10   | M4X0.7    | 10   | 15 | 5.6  | 50 | S-SİSTEM için / For S-SYSTEM / FÜR S-SYSTEM    | TORK VİDA / TORX SCREW / TORX-SCHRAUBEN |
| 4015-M4x11   | M4X0.7    | 11   | 15 | 5.6  | 50 | S-SİSTEM için / For S-SYSTEM / FÜR S-SYSTEM    | TORK VİDA / TORX SCREW / TORX-SCHRAUBEN |
| 4015-M4x12   | M4X0.7    | 12   | 15 | 5.7  | 50 | S-SİSTEM için / For S-SYSTEM / FÜR S-SYSTEM    | TORK VİDA / TORX SCREW / TORX-SCHRAUBEN |
| 4115-M4x12   | M4X0.7    | 12   | 15 | 5.6  | 55 | S-SİSTEM için / For S-SYSTEM / FÜR S-SYSTEM    | TORK VİDA / TORX SCREW / TORX-SCHRAUBEN |
| 4515-M4x8  | M4X0.7    | 8    | 15 | 5.1  | 50 | S-SİSTEM için / For S-SYSTEM / FÜR S-SYSTEM    | TORK VİDA / TORX SCREW / TORX-SCHRAUBEN |
| 4515-M4x11   | M4X0.7    | 11   | 15 | 5.1  | 50 | S-SİSTEM için / For S-SYSTEM / FÜR S-SYSTEM    | TORK VİDA / TORX SCREW / TORX-SCHRAUBEN |
| 4615-M4x11   | M4X0.7    | 11   | 15 | 6    | 50 | S-SİSTEM için / For S-SYSTEM / FÜR S-SYSTEM    | TORK VİDA / TORX SCREW / TORX-SCHRAUBEN |
| 1015-M4.5x12                                       | M4.5X0.75 | 12   | 15 | 6.6  | 50 | S-SİSTEM için / For S-SYSTEM / FÜR S-SYSTEM    | TORK VİDA / TORX SCREW / TORX-SCHRAUBEN |
| 1020-M4.5x14                                       | M4.5X0.75 | 14   | 20 | 6.5  | 45 | S-SİSTEM için / For S-SYSTEM / FÜR S-SYSTEM    | TORK VİDA / TORX SCREW / TORX-SCHRAUBEN |
| 1020-M4.5x16                                       | M4.5X0.75 | 16   | 20 | 6.5  | 45 | S-SİSTEM için / For S-SYSTEM / FÜR S-SYSTEM    | TORK VİDA / TORX SCREW / TORX-SCHRAUBEN |
| 1120-M4.5x12                                       | M4.5X0.75 | 12.1 | 20 | 7.9  | R  | S-SİSTEM için / For S-SYSTEM / FÜR S-SYSTEM    | TORK VİDA / TORX SCREW / TORX-SCHRAUBEN |
| 1515-M4.5x11                                       | M4.5X0.75 | 11   | 15 | 6.4  | 45 | S-SİSTEM için / For S-SYSTEM / FÜR S-SYSTEM    | TORK VİDA / TORX SCREW / TORX-SCHRAUBEN |
| 4015-M4.5x11                                       | M4.5X0.75 | 11   | 15 | 6.4  | 45 | S-SİSTEM için / For S-SYSTEM / FÜR S-SYSTEM    | TORK VİDA / TORX SCREW / TORX-SCHRAUBEN |
| 4020-M4.5x10                                       | M4.5X0.75 | 10   | 20 | 6.5  | 55 | S-SİSTEM için / For S-SYSTEM / FÜR S-SYSTEM    | TORK VİDA / TORX SCREW / TORX-SCHRAUBEN |
| 4020-M4.5x12                                       | M4.5X0.75 | 12   | 20 | 6.5  | 55 | S-SİSTEM için / For S-SYSTEM / FÜR S-SYSTEM    | TORK VİDA / TORX SCREW / TORX-SCHRAUBEN |
| 1020-M5x7.5  | M5X0.8    | 7.5  | 20 | 6.5  | 50 | S-SİSTEM için / For S-SYSTEM / FÜR S-SYSTEM    | TORK VİDA / TORX SCREW / TORX-SCHRAUBEN |
| 1020-M5x11   | M5X0.8    | 11   | 20 | 6.6  | 50 | S-SİSTEM için / For S-SYSTEM / FÜR S-SYSTEM    | TORK VİDA / TORX SCREW / TORX-SCHRAUBEN |
| 1020-M5x14   | M5X0.8    | 14.1 | 20 | 6.8  | 50 | S-SİSTEM için / For S-SYSTEM / FÜR S-SYSTEM    | TORK VİDA / TORX SCREW / TORX-SCHRAUBEN |
| 1120-M5x13   | M5X0.8    | 13   | 20 | 7    | R  | S-SİSTEM için / For S-SYSTEM / FÜR S-SYSTEM    | TORK VİDA / TORX SCREW / TORX-SCHRAUBEN |
| 1615-M5x14   | M5X0.8    | 14   | 15 | 7.3  | 50 | S-SİSTEM için / For S-SYSTEM / FÜR S-SYSTEM    | TORK VİDA / TORX SCREW / TORX-SCHRAUBEN |
| 1620-M5x18   | M5X0.8    | 18   | 20 | 8.15 | 50 | S-SİSTEM için / For S-SYSTEM / FÜR S-SYSTEM    | TORK VİDA / TORX SCREW / TORX-SCHRAUBEN |
| 1620-M5x22   | M5X0.8    | 22   | 20 | 8.15 | 50 | S-SİSTEM için / For S-SYSTEM / FÜR S-SYSTEM    | TORK VİDA / TORX SCREW / TORX-SCHRAUBEN |
| 4420-M5x14   | M5X0.8    | 14   | 20 | 6.6  | 60 | S-SİSTEM için / For S-SYSTEM / FÜR S-SYSTEM    | TORK VİDA / TORX SCREW / TORX-SCHRAUBEN |
| 1020-M6x16   | M6X1.0    | 16   | 20 | 8.5  | 50 | S-SİSTEM için / For S-SYSTEM / FÜR S-SYSTEM    | TORK VİDA / TORX SCREW / TORX-SCHRAUBEN |
| 1420-M6x16   | M6X1.0    | 16   | 20 | 7.6  | 50 | S-SİSTEM için / For S-SYSTEM / FÜR S-SYSTEM    | TORK VİDA / TORX SCREW / TORX-SCHRAUBEN |
| 1520-M6x16   | M6X1.0    | 16   | 20 | 8.2  | 50 | S-SİSTEM için / For S-SYSTEM / FÜR S-SYSTEM    | TORK VİDA / TORX SCREW / TORX-SCHRAUBEN |
| 1710-U5-40x12.2                                    | UNC 5-40  | 12.2 | 10 | 5.6  | 60 | S-SİSTEM için / For S-SYSTEM / FÜR S-SYSTEM    | TORK VİDA / TORX SCREW / TORX-SCHRAUBEN |
| 1720-U8-32x10                                      | UNC 8-32  | 10   | 20 | 7.5  | 60 | S-SİSTEM için / For S-SYSTEM / FÜR S-SYSTEM    | TORK VİDA / TORX SCREW / TORX-SCHRAUBEN |
| 1720-U8-32x15                                      | UNC 8-32  | 15   | 20 | 7.5  | 60 | S-SİSTEM için / For S-SYSTEM / FÜR S-SYSTEM    | TORK VİDA / TORX SCREW / TORX-SCHRAUBEN |
| 1707-U4-48x6                                       | UNF 4-48  | 6    | 7  | 3.27 | 60 | S-SİSTEM için / For S-SYSTEM / FÜR S-SYSTEM    | TORK VİDA / TORX SCREW / TORX-SCHRAUBEN |
| 1707-U4-48x6.5                                     | UNF 4-48  | 6.5  | 7  | 3.27 | 60 | S-SİSTEM için / For S-SYSTEM / FÜR S-SYSTEM    | TORK VİDA / TORX SCREW / TORX-SCHRAUBEN |
| 1707-U4-48x8.2                                     | UNF 4-48  | 8.2  | 7  | 3.27 | 60 | S-SİSTEM için / For S-SYSTEM / FÜR S-SYSTEM    | TORK VİDA / TORX SCREW / TORX-SCHRAUBEN |

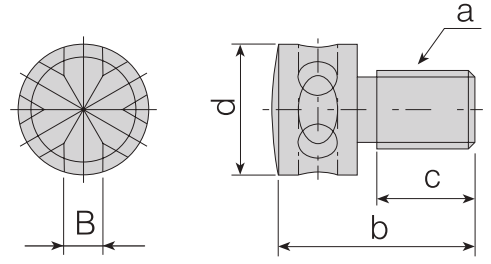

EKSENEL AYAR VİDALARI / AXIAL ADJUSTING SCREWS / AXIAL-EINSTELLSCHRAUBE

| Takım Kodu<br>Ordering Code<br>Bestell-Bezeichnung | a (M)  | b   | c | d  | B   | Ürün Detayı / Product Detail / Produkt-Details |   |
|--|--------|-----|---|----|-----|--|---|
|  |        |     |   |    |     |  |   |
| 2600-M4x9.5  | M4x0.5 | 9.5 | 4 | 4  | 1.5 | Kartuş için / for Cartridge / FÜR KASSETTE     | Eksenel Ayar Vida / Axial Adjust Screw / Axial-Einstellschraube |
| 2600-M5x13   | M5x0.5 | 13  | 7 | 8  | 2.5 | Kartuş için / for Cartridge / FÜR KASSETTE     | Eksenel Ayar Vida / Axial Adjust Screw / Axial-Einstellschraube |
| 2600-M6x18   | M6x1.0 | 18  | 9 | 10 | 3.5 | Kartuş için / for Cartridge / FÜR KASSETTE     | Eksenel Ayar Vida / Axial Adjust Screw / Axial-Einstellschraube |

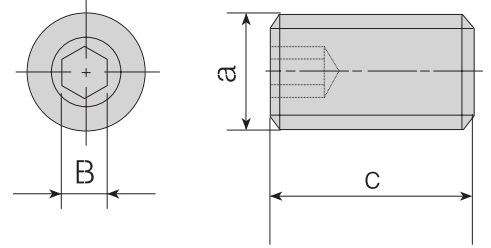

RADYAL AYAR VİDALARI / RADIAL ADJUSTING SCREWS / AXIAL-EINSTELLSCHRAUBE

| Takım Kodu<br>Ordering Code<br>Bestell-Bezeichnung | a (M)   | c    | B   | Ürün Detayı / Product Detail / Produkt-Details                                       |   |
|--|---------|------|-----|--|---|
|  |         |      |     |  |   |
| 2715-M3x4  | M3x0.5  | 4    | 1.5 | KABA BARA için / for ROUGH BORING HEADS<br>FÜR SCHRUPP-SPINDELKOPF                   | KABA BARA KARTUŞU için / for ROUGH BORING HEADS CARTRIDGE<br>FÜR KASSETTEN DER SCHRUPP-SPINDELKÖPFE |
| 2715-M3x5  | M3x0.5  | 5    | 1.5 | KABA BARA için / for ROUGH BORING HEADS<br>FÜR SCHRUPP-SPINDELKOPF                   | KABA BARA KARTUŞU için / for ROUGH BORING HEADS CARTRIDGE<br>FÜR KASSETTEN DER SCHRUPP-SPINDELKÖPFE |
| 2715-M3x8  | M3x0.5  | 8    | 1.5 | KABA BARA için / for ROUGH BORING HEADS<br>FÜR SCHRUPP-SPINDELKOPF                   | KABA BARA KARTUŞU için / for ROUGH BORING HEADS CARTRIDGE<br>FÜR KASSETTEN DER SCHRUPP-SPINDELKÖPFE |
| 2702-M4x4  | M4x0.7  | 4    | 2   | KARTUŞ için / for CARTRIDGE / FÜR KASSETTE   | KARTUŞ için / for CARTRIDGE / FÜR KASSETTE  |
| 2702-M4x10   | M4x0.7  | 10   | 2   | KARTUŞ için / for CARTRIDGE / FÜR KASSETTE   | KARTUŞ için / for CARTRIDGE / FÜR KASSETTE  |
| 2702-M4x12   | M4x0.7  | 12   | 2   | KABA BARA için / for ROUGH BORING HEADS<br>FÜR SCHRUPP-SPINDELKOPF                   | KABA BARA KARTUŞU için / for ROUGH BORING HEADS CARTRIDGE<br>FÜR KASSETTEN DER SCHRUPP-SPINDELKÖPFE |
| 2725-M5x6  | M5x0.8  | 5    | 2.5 | KARTUŞ için / for CARTRIDGE / FÜR KASSETTE   | KARTUŞ için / for CARTRIDGE / FÜR KASSETTE  |
| 2725-M5x10   | M5x0.8  | 10   | 2.5 | KARTUŞ için / for CARTRIDGE / FÜR KASSETTE   | KARTUŞ için / for CARTRIDGE / FÜR KASSETTE  |
| 2725-M5x12   | M5x0.8  | 12   | 2.5 | KABA BARA için / for ROUGH BORING HEADS<br>FÜR SCHRUPP-SPINDELKOPF                   | KABA BARA KARTUŞU için / for ROUGH BORING HEADS CARTRIDGE<br>FÜR KASSETTEN DER SCHRUPP-SPINDELKÖPFE |
| 2725-M5x14   | M5x0.8  | 14   | 2.5 | KABA BARA için / for ROUGH BORING HEADS<br>FÜR SCHRUPP-SPINDELKOPF                   | KABA BARA KARTUŞU için / for ROUGH BORING HEADS CARTRIDGE<br>FÜR KASSETTEN DER SCHRUPP-SPINDELKÖPFE |
| 2703-M6x16   | M6x1    | 16   | 3   | KABA BARA için / for ROUGH BORING HEADS<br>FÜR SCHRUPP-SPINDELKOPF                   | KABA BARA KARTUŞU için / for ROUGH BORING HEADS CARTRIDGE<br>FÜR KASSETTEN DER SCHRUPP-SPINDELKÖPFE |
| 2704-M8x25   | M8x1.25 | 25.9 | 4   | KABA BARA için / for ROUGH BORING HEADS<br>FÜR SCHRUPP-SPINDELKOPF                   | KABA BARA KARTUŞU için / for ROUGH BORING HEADS CARTRIDGE<br>FÜR KASSETTEN DER SCHRUPP-SPINDELKÖPFE |
| 2704-M8x1x5  | M8x1    | 5    | 4   | İÇTEN SOĞUTMA KANALLI TAKIMLAR için /<br>for COOLANT TOOLS / IFÜRAUSSEN - DREHHALTER | JET TAKIMLAR için / For JET TOOLS / FÜR JET WERKZEUGE   |
| 2705-G1/8x5.5                                      | G1/8    | 5.5  | 5   | İÇTEN SOĞUTMA KANALLI TAKIMLAR için /<br>for COOLANT TOOLS / IFÜRAUSSEN - DREHHALTER | JET TAKIMLAR için / For JET TOOLS / FÜR JET WERKZEUGE   |

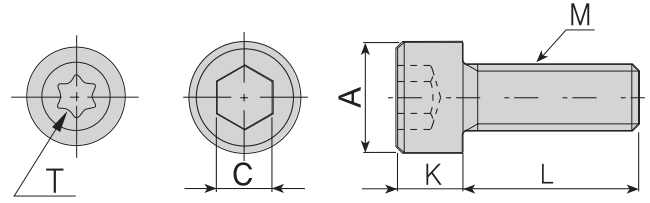

İNBUS CİVATALAR / INBUS SCREWS / INNENSECHSKANT-SCHRAUBE

| Takım Kodu<br>Ordering Code<br>Bestell-Bezeichnung | M        | A    | C   | K    | L    | Ürün Detayı / Product Detail / Produkt-Details                     |  |
|--|----------|------|-----|------|------|--|--|
|  |          |      |     |      |      | Ürün Detayı / Product Detail / Produkt-Details                     | SCHRAUBE FÜR KASSETTE DER SCHRUPP-SPINDELKÖPFE |
| 2503-M4x10   | M4x0.7   | 6.85 | 3   | 4    | 10   | KANAL KATER VİDASI / SOME GROOVING TOOLS SCREW                     | SCHRAUBEN FÜR STECHHALTER                      |
| 2525-M3X14   | M3X0.5   | 5.4  | 2.5 | 2.9  | 14   | BARA KARTUŞU İÇİN SIKMA VİDASI / for BORING HEADS CARTRIDGE SCREW  | SCHRAUBE FÜR KASSETTE DER SCHRUPP-SPINDELKÖPFE |
| 2503-M4X20   | M4x0.7   | 7    | 3   | 3.9  | 20   | BARA KARTUŞU İÇİN SIKMA VİDASI / for BORING HEADS CARTRIDGE SCREW  | SCHRAUBE FÜR KASSETTE DER SCHRUPP-SPINDELKÖPFE |
| 2503-M4X12   | M4x0.7   | 6.85 | 3   | 4    | 12   | KANAL KATER VİDASI / SOME GROOVING TOOLS SCREW                     | SCHRAUBEN FÜR STECHHALTER                      |
| 2503-M4X15   | M4x0.7   | 6.85 | 3   | 4    | 15   | BARA KARTUŞU İÇİN SIKMA VİDASI / for BORING HEADS CARTRIDGE SCREW  | SCHRAUBE FÜR KASSETTE DER SCHRUPP-SPINDELKÖPFE |
| 2504-M5X16   | M5X0.8   | 8.5  | 4   | 5    | 16   | KANAL KATER VİDASI / SOME GROOVING TOOLS SCREW                     | SCHRAUBEN FÜR STECHHALTER                      |
| 2504-M5X12   | M5X0.8   | 8.5  | 4   | 5    | 12   | KANAL KATER VİDASI / SOME GROOVING TOOLS SCREW                     | SCHRAUBEN FÜR STECHHALTER                      |
| 2504-M5X25   | M5X0.8   | 8.5  | 4   | 5    | 25   | BARA KARTUŞU İÇİN SIKMA VİDASI / for BORING HEADS CARTRIDGE SCREW  | SCHRAUBE FÜR KASSETTE DER SCHRUPP-SPINDELKÖPFE |
| 2505-M6X16   | M6X1     | 9.9  | 5   | 6    | 16   | KANAL KATER VİDASI / SOME GROOVING TOOLS SCREW                     | SCHRAUBEN FÜR STECHHALTER                      |
| 2505-M6X20   | M6X1     | 9.9  | 5   | 6    | 20   | KANAL KATER VİDASI / SOME GROOVING TOOLS SCREW                     | SCHRAUBEN FÜR STECHHALTER                      |
| 2505-M6X25   | M6X1     | 9.9  | 5   | 6    | 25   | BLOK BASKI PABUÇ VİDASI / for BLOCK CLAMP SCREW                    | SCHRAUBE FÜR SPANNBLOCK                        |
| 2505-M6X30   | M6X1     | 9.9  | 5   | 6    | 30   | BARA KARTUŞU İÇİN SIKMA VİDASI / for BORING HEADS CARTRIDGE SCREW  | SCHRAUBE FÜR KASSETTE DER SCHRUPP-SPINDELKÖPFE |
| 2306-M8X37   | M8X1.25  | 13   | 6   | 6.4  | 31.5 | MONTAJ VİDASI (KAFASI KÜÇÜK) / MOUNTING SCREW (SMALL HEAD)         | BEFESTIGUNGSSCHRAUBE                           |
| 2405-M8X30   | M8X1.25  | 13   | 5   | 5    | 30   | A16 MONTAJ VİDASI (KAFASI KÜÇÜK) / MOUNTING SCREW (SMALL HEAD)     | BEFESTIGUNGSSCHRAUBE (KLEINER KOPF)            |
| 2506-M8X20   | M8X1.25  | 13   | 6   | 7.9  | 20   | KARTUŞ MONTAJ VİDASI / CARTRIDGE MOUNTING SCREW                    | BEFESTIGUNGSSCHRAUBE FÜR KASSETTE              |
| 2506-M8X30   | M8X1.25  | 13   | 6   | 7.9  | 30   | A16 MONTAJ VİDASI / MOUNTING SCREW                                 | BEFESTIGUNGSSCHRAUBE                           |
| 2506-M8X35   | M8X1.25  | 13   | 6   | 7.9  | 35   | BARA KARTUŞU İÇİN SIKMA VİDASI / for BORING HEADS CARTRIDGE SCREW  | SCHRAUBE FÜR KASSETTE DER SCHRUPP-SPINDELKÖPFE |
| 2406-M8X30   | M8X1.25  | 12   | 6   | 7.9  | 30   | A16 MONTAJ VİDASI / MOUNTING SCREW                                 | BEFESTIGUNGSSCHRAUBE                           |
| 2407-M10X30  | M10X1.5  | 16   | 7   | 6    | 30   | A16 MONTAJ VİDASI / MOUNTING SCREW                                 | BEFESTIGUNGSSCHRAUBE                           |
| 2408-M10X30  | M10X1.5  | 13   | 8   | 10   | 30   | A22 MONTAJ VİDASI / MOUNTING SCREW                                 | BEFESTIGUNGSSCHRAUBE                           |
| 2508-M10X30  | M10X1.5  | 16   | 8   | 10   | 30   | A22 MONTAJ VİDASI / MOUNTING SCREW                                 | BEFESTIGUNGSSCHRAUBE                           |
| 2508-M10X40  | M10X1.5  | 16   | 8   | 10   | 40   | BARA KARTUŞU İÇİN SIKMA VİDASI / for BORING HEADS CARTRIDGE SCREWS | SCHRAUBE FÜR KASSETTE DER SCHRUPP-SPINDELKÖPFE |
| 2408-M12X35  | M12X1.75 | 18   | 8   | 7    | 35   | A27 MONTAJ VİDASI / MOUNTING SCREW                                 | BEFESTIGUNGSSCHRAUBE                           |
| 2510-M12X35  | M12X1.75 | 18   | 10  | 12   | 35   | A27 MONTAJ VİDASI / MOUNTING SCREW                                 | BEFESTIGUNGSSCHRAUBE                           |
| 2514-M16X35  | M16X2.0  | 23.7 | 14  | 16   | 35   | A32 MONTAJ VİDASI / MOUNTING SCREW                                 | BEFESTIGUNGSSCHRAUBE                           |
| AAV-11-U5-40x4.5                                   | UNC 5-40 | 5.4  | T10 | 2.8  | 4.5  | 16 ER/L, 16 IR/L ALTLIK VİDASI / SHIM SCREW                        | SCHRAUBE FÜR UNTERLAGE                         |
| AAV-12-U8-32x5.5                                   | UNC 8-32 | 6.7  | T20 | 3.8  | 5.5  | 22 ER/L, 22 IR/L ALTLIK VİDASI / SHIM SCREW                        | SCHRAUBE FÜR UNTERLAGE                         |
| AAV-15-M5x5.7                                      | M5X0.8   | 8.5  | T20 | 3.15 | 5.7  | 27 ER/L, 27 IR/L ALTLIK VİDASI / SHIM SCREW                        | SCHRAUBE FÜR UNTERLAGE                         |

SEGMAN / RING / RING

| Ürün Resmi<br>Product Picture<br>Produkt-Bild | Ürün Kodu<br>Product Code / Code | Ürün Detayı / Product Detail / Produkt-Details    |   |
|---|----------------------------------|---|---|
|   |                                  | ACS-01  | C-SİSTEM için / For C-SYSTEM / FÜR C-SYSTEM |
| AS-01   |                                  | T-M-SİSTEM için / For T-M-SYSTEM / FÜR T-M-SYSTEM | AKV-30-M6x22 SEGMANI / RING                 |
| AS-02   |                                  | T SİSTEM için / For T SYSTEM / FÜR T-SYSTEM       | AKV-19-M7x25 SEGMANI / RING                 |

ORING / ORING / ORING

| Ürün Resmi<br>Product Picture<br>Produkt-Bild | ORING / ORING / ORING            |   |  |
|---|----------------------------------|---|--|
|   | Ürün Kodu<br>Product Code / Code | Ürün Detayı / Product Detail / Produkt-Details  |  |
|   | <b>AOR-01</b>                    | P-SİSTEM için / For P-SYSTEM / FÜR P-SYSTEM     |  |
|   | <b>AXR-01</b>                    | T-P SİSTEM için / For T-P SYSTEM / FÜR P-SYSTEM |  |

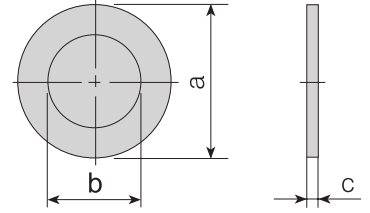

BASKI VE ALTLIK VİDASI PULU / STAMP / UNTERLEGSCHIEBE

| Takım Kodu<br>Ordering Code<br>Bestell-Bezeichnung | a     | b   | c    | Ürün Detayı / Product Detail / Produkt-Details |   |
|--|-------|-----|------|--|---|
|  |       |     |      | PUL/STAMP/RING                                 | BASKI PULU / STAMP / RING   |
| <b>ABPL-01</b>                                     | 10.5  | 6.2 | 0.5  | PUL/STAMP/RING                                 | BASKI PULU / STAMP / RING   |
| <b>ABPL-02</b>                                     | 12.75 | 7.1 | 0.45 | PUL/STAMP/RING                                 | BASKI PULU / STAMP / RING   |
| <b>ABPL-03</b>                                     | 5.3   | 3.2 | 0.5  | PUL/STAMP/RING                                 | TER - TIR 16 ER/EL - İR/İL ALTLIK VİDASI PULU / SHIM SCREW RING / SHIM SCREW RING / SCHRAUBE FÜR UNTERLAGENRING |
| <b>ABPL-04</b>                                     | 6.9   | 4.2 | 0.5  | PUL/STAMP/RING                                 | TER - TIR 22 ER/EL - İR/İL ALTLIK VİDASI PULU / SHIM SCREW RING / SHIM SCREW RING / SCHRAUBE FÜR UNTERLAGENRING |
| <b>ABPL-05</b>                                     | 8.5   | 5   | 0.5  | PUL/STAMP/RING                                 | TER - TIR 27 ER/EL - İR/İL ALTLIK VİDASI PULU / SHIM SCREW RING / SHIM SCREW RING / SCHRAUBE FÜR UNTERLAGENRING |

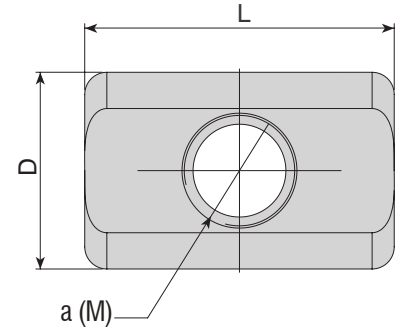
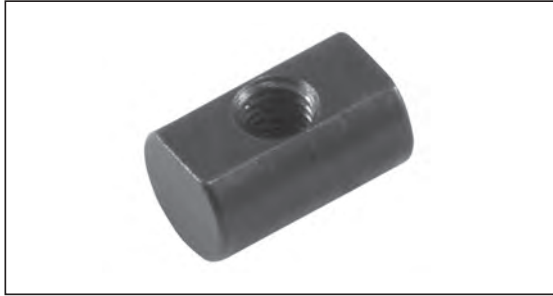



BARA PABUÇLARI / BORING HEADS CARTRIDGE / KASSETTE FÜR SPINDELKOPF

| Takım Kodu<br>Ordering Code<br>Bestell-Bezeichnung | a (M)    | D    | L  | Ürün Detayı / Product Detail / Produkt-Details                    |  |
|--|----------|------|----|---|--|
|  |          |      |    | KABA BARA için / for ROUGH BORING HEADS / FÜR SCHRUPP-SPINDELKOPF | ABHR-D16x42-W16-L90                            |
| <b>ABKS-D16</b>                                    | M3x0.5   | 4.9  | 6  | KABA BARA için / for ROUGH BORING HEADS / FÜR SCHRUPP-SPINDELKOPF | ABHR-D16x42-W16-L90                            |
| <b>ABKS-D20</b>                                    | M4x0.7   | 5.9  | 9  | ABA BARA için / for ROUGH BORING HEADS / FÜR SCHRUPP-SPINDELKOPF  | ABHR-D20x50-W20-L100                           |
| <b>ABKS-D25</b>                                    | M4x0.7   | 5.9  | 12 | KABA BARA için / for ROUGH BORING HEADS / FÜR SCHRUPP-SPINDELKOPF | ABHR-D25x60-W20-L110                           |
| <b>ABKS-D32</b>                                    | M5x0.8   | 8.9  | 14 | KABA BARA için / for ROUGH BORING HEADS / FÜR SCHRUPP-SPINDELKOPF | ABHR-D32x64-W25-L120                           |
| <b>ABKS-D40</b>                                    | M6x1     | 10.9 | 18 | KABA BARA için / for ROUGH BORING HEADS / FÜR SCHRUPP-SPINDELKOPF | ABHR-D40x80-W32-L140                           |
| <b>ABKS-D50</b>                                    | M8x1.25  | 13.9 | 28 | KABA BARA için / for ROUGH BORING HEADS / FÜR SCHRUPP-SPINDELKOPF | ABHR-D50x100-W32-L160                          |
| <b>ABKS-D63</b>                                    | M10x1.5  | 15.9 | 35 | KABA BARA için / for ROUGH BORING HEADS / FÜR SCHRUPP-SPINDELKOPF | ABHR-D63x80-W32-L140, ABHR-D63x130-W40-L200    |
| <b>ABKS-D80</b>                                    | M12x1.75 | 17.9 | 45 | KABA BARA için / for ROUGH BORING HEADS / FÜR SCHRUPP-SPINDELKOPF | ABHR-D80x140-W40-L210, ABHR-D80x140-W40-L210-B |





| Ürün Resmi<br>Product Picture<br>Produkt-Bild                                    | KESME ve KANAL LAMA AÇMA BLOK PABUÇLARI / BLOCKS FOR PARTING AND DEEP GROOVING BLADES CLAMPS<br>KLEMMLEISTE FÜR SCHWERT-SPANNBLOCK |  |  |
|--|--|--|--|
|  | Ürün Kodu<br>Product Code / Code   | Ürün Detayı / Product Detail / Produkt-Details             |  |
|  | <b>ABK-01</b>  | LAMA BLOĞU için / For BLADE BLOCK / FÜR SCHWERT-SPANNBLOCK | ALBU-20-26 BASKI PABUCU / CLAMP / PRATZE             |
|  | <b>ABK-02</b>  | LAMA BLOĞU için / For BLADE BLOCK / FÜR SCHWERT-SPANNBLOCK | ALBU-25-26 BASKI PABUCU / CLAMP / PRATZE             |
|  | <b>ABK-03</b>  | LAMA BLOĞU için / For BLADE BLOCK / FÜR SCHWERT-SPANNBLOCK | ALBU-20-32 BASKI PABUCU / CLAMP / PRATZE             |
|  | <b>ABK-04</b>  | LAMA BLOĞU için / For BLADE BLOCK / FÜR SCHWERT-SPANNBLOCK | ALBU-25-32, ALBU-32-32 BASKI PABUCU / CLAMP / PRATZE |

| Ürün Resmi<br>Product Picture<br>Produkt-Bild                                      | LAMA ANAHTARI / BLADE KEY / SCHWERT-SCHLÜSSEL |   |
|--|---|---|
|  | Ürün Kodu<br>Product Code / Code              | Ürün Detayı / Product Detail / Produkt-Details        |
|  | <b>ALA-01</b>                                 | AKL LAMA ANAHTARI / for BLADE KEY / SCHWERT-SCHLÜSSEL |
|  | <b>ALA-02</b>                                 | AKL LAMA ANAHTARI / for BLADE KEY / SCHWERT-SCHLÜSSEL |

| Ürün Resmi<br>Product Picture<br>Produkt-Bild                                      | ALYAN ANAHTARLARI / ALLEN KEYS / INNENSECHSKANT-SCHLÜSSEL |  |  |
|--|---|--|--|
|  | Ürün Kodu<br>Product Code / Code                          | Ürün Detayı / Product Detail / Produkt-Details |  |
|  | <b>AAL-01-2</b>   | 2 mm   | ALYAN ANAHTARI / ALLEN KEYS / INNENSECHSKANT-SCHLÜSSEL |
|  | <b>AAL-02-2.5</b>   | 2.5 mm   | ALYAN ANAHTARI / ALLEN KEYS / INNENSECHSKANT-SCHLÜSSEL |
|  | <b>AAL-03-3</b>   | 3 mm   | ALYAN ANAHTARI / ALLEN KEYS / INNENSECHSKANT-SCHLÜSSEL |
|  | <b>AAL-05-4</b>   | 4 mm   | ALYAN ANAHTARI / ALLEN KEYS / INNENSECHSKANT-SCHLÜSSEL |
|  | <b>AAL-07-5</b>   | 5 mm   | ALYAN ANAHTARI / ALLEN KEYS / INNENSECHSKANT-SCHLÜSSEL |
|  | <b>AAL-08-6</b>   | 6 mm   | ALYAN ANAHTARI / ALLEN KEYS / INNENSECHSKANT-SCHLÜSSEL |
|  | <b>AAL-09-1.5</b>   | 1.5 mm   | ALYAN ANAHTARI / ALLEN KEYS / INNENSECHSKANT-SCHLÜSSEL |
|  | <b>AAL-11-8</b>   | 8 mm   | ALYAN ANAHTARI / ALLEN KEYS / INNENSECHSKANT-SCHLÜSSEL |
|  | <b>AAL-12-10</b>  | 10 mm  | ALYAN ANAHTARI / ALLEN KEYS / INNENSECHSKANT-SCHLÜSSEL |

| Ürün Resmi<br>Product Picture<br>Produkt-Bild                                       | TORK ANAHTARLARI / TORX KEYS / TORX-SCHLÜSSEL |  |
|---|---|--|
|   | Ürün Kodu<br>Product Code / Code              | Ürün Detayı / Product Detail / Produkt-Details                   |
|  | <b>82-T06</b>                                 | T06 TORK ANAHTARI / TORX KEY / TORX-SCHLÜSSEL                    |
|   | <b>82-T07</b>                                 | T07 TORK ANAHTARI / TORX KEY / TORX-SCHLÜSSEL                    |
|   | <b>82-T08</b>                                 | T08 TORK ANAHTARI / TORX KEY / TORX-SCHLÜSSEL                    |
|   | <b>82-T10</b>                                 | T10 TORK ANAHTARI / TORX KEY / TORX-SCHLÜSSEL                    |
|   | <b>80-T15</b>                                 | T15 TORK ANAHTARI / TORX KEY / TORX-SCHLÜSSEL                    |
|   | <b>80-T20</b>                                 | T20 TORK ANAHTARI / TORX KEY / TORX-SCHLÜSSEL                    |
|   | <b>81-T15</b>                                 | T15 T-TİP TORK ANAHTARI / T-TYPE TORX KEY / T-TYP-TORX-SCHLÜSSEL |
|   | <b>81-T20</b>                                 | T20 T-TİP TORK ANAHTARI / T-TYPE TORX KEY / T-TYP-TORX-SCHLÜSSEL |

| KOD / CODE          | AÇIKLAMA / DESCRIPTION                            | BESCHREIBUNG  | SN. / PN. SEITE |
|---------------------|---|---|-----------------|
| A/PTFNR/L ..        | Boring Bars                                       | Bohstangen  | 92              |
| A/SCLCR/L ..        | Boring Bars SET                                   | Bohstangen Set  | 96              |
| A/SDUCR/L ..        | Boring Bars SET                                   | Bohstangen Set  | 99              |
| AAKT-IG-R/L ..      | Face External Grooving Tool Holders               | Axial Stechhalter                                     | 164             |
| AAKT-KG-R/L ..      | Face External Grooving Tool Holders               | Axial Stechhalter                                     | 163             |
| AAKT-K-R/L ..       | Face External Grooving Tool Holders               | Axial Stechhalter                                     | 162             |
| AAKT-SGC-T-R/L ..   | Face External Grooving Tool Holders               | Axial Stechhalter                                     | 164             |
| AAKT-WGX24-T-R/L .. | Face External Grooving Tool Holders               | Axial Stechhalter                                     | 165             |
| AAKT-ZCC2-R/L ..    | Face External Grooving Tool Holders               | Axial Stechhalter                                     | 163             |
| ABHF ..             | Adjustable Finish Boring Heads                    | EINSTELLBARE BOHRKÖPFE                                | 227             |
| ABHR ..             | Adjustable Rough Boring Heads                     | EINSTELLBARE SPINDELKÖPFE                             | 231             |
| ABHRS ..            | Adjustable Rough Boring Heads Body                | TRÄGERWERKZEUGE FÜR EINSTELLBARE SCHRUPP-SPINDELKÖPFE | 232             |
| ACBM ..             | Countersink Open Milling Tools                    | Senkwerkzeuğf.Zylinderkopf-schrauben                  | 239             |
| ACM ..              | Chamfering End Mills                              | Fasfräser   | 237             |
| ACM45-SP..          | Chamfering End Mills                              | Fasfräser   | 238             |
| ACPBT..             | Pipe Beveling Tools                               | Rohrendenanaswerkzeug                                 | 131             |
| ADCR                | Drill Chamfering Ring Tools                       | Rohrendenanaswerkzeug                                 | 218             |
| ADKT-123-R/L ..     | External Grooving Tool Holders                    | Außen - Stechhalter                                   | 149             |
| ADKT-123-S-R/L ..   | External Grooving (Swiss Type) Tool Holders       | Außen - Stechhalter (SwissType)                       | 161             |
| ADKT-151.22-R/L ..  | External Grooving Tool Holders                    | Außen - Stechhalter                                   | 150             |
| ADKT-151.23-R/L ..  | External Grooving Tool Holders                    | Außen - Stechhalter                                   | 150             |
| ADKT-154.91-R/L ..  | External Grooving Tool Holders                    | Außen - Stechhalter                                   | 151             |
| ADKT-ARN-R/L ..     | External Grooving Tool Holders                    | Außen - Stechhalter                                   | 151             |
| ADKT-CD-R/L ..      | External Grooving Tool Holders                    | Außen - Stechhalter                                   | 157             |
| ADKT-GB-R/L ..      | External Grooving Tool Holders                    | Außen - Stechhalter                                   | 154             |
| ADKT-GP-R/L ..      | External Grooving Tool Holders                    | Außen - Stechhalter                                   | 156             |
| ADKT-GY2-R/L ..     | External Grooving Tool Holders                    | Außen - Stechhalter                                   | 157             |
| ADKT-H22-R/L ..     | External Grooving Tool Holders                    | Außen - Stechhalter                                   | 154             |
| ADKT-HK-R/L ..      | External Grooving Tool Holders                    | Außen - Stechhalter                                   | 145             |
| ADKT-H-R/L ..       | External Grooving Tool Holders                    | Außen - Stechhalter                                   | 144             |
| ADKT-HS223 R/L ..   | External Grooving Tool Holders                    | Außen - Stechhalter                                   | 145             |
| ADKT-IDC-R/L ..     | External Grooving Tool Holders                    | Außen - Stechhalter                                   | 148             |
| ADKT-IGI-R/L ..     | External Grooving Tool Holders                    | Außen - Stechhalter                                   | 148             |
| ADKT-IG-R/L ..      | External Grooving Tool Holders                    | Außen - Stechhalter                                   | 148             |
| ADKT-IGTN-R/L ..    | External Grooving Tool Holders                    | Außen - Stechhalter                                   | 148             |
| ADKT-I-R/L ..       | External Grooving Tool Holders                    | Außen - Stechhalter                                   | 148             |
| ADKT-I-R/L ..S      | External Grooving (Swiss Type) Tool Holders       | Außen - Stechhalter (SwissType)                       | 159             |
| ADKT-ITG-R/L ..     | External Grooving Tool Holders                    | Außen - Stechhalter                                   | 147             |
| ADKT-KG-R/L ..      | External Grooving Tool Holders                    | Außen - Stechhalter                                   | 143             |
| ADKT-KG-R/L ..S     | External Grooving (Swiss Type) Tool Holders       | Außen - Stechhalter (SwissType)                       | 160             |
| ADKT-KM-R/L ..      | External Grooving Tool Holders                    | Außen - Stechhalter                                   | 147             |
| ADKT-K-R/L ..       | External Grooving Tool Holders                    | Außen - Stechhalter                                   | 142             |
| ADKT-K-R/L .. -H    | External Grooving Tool Holders With Coolant Tools | Externe Nutwerkzeughalter Mit Kühlwerkzeug            | 143             |
| ADKT-K-R/L ..S      | External Grooving (Swiss Type) Tool Holders       | Außen - Stechhalter (SwissType)                       | 160             |
| ADKT-LGC-R/L ..     | External Grooving Tool Holders                    | Außen - Außen - Stechhalter                           | 153             |

| KOD / CODE        | AÇIKLAMA / DESCRIPTION                            | BESCHREIBUNG                               | SN. / PN. SEITE |
|-------------------|---|--|-----------------|
| ADKT-RD-R/L ..    | External Grooving Tool Holders                    | Außen - Stechhalter                        | 153             |
| ADKT-RD-R/L .. -S | External Grooving (Swiss Type) Tool Holders       | Außen - Stechhalter (SwissType)            | 158             |
| ADKT-SGC-T-R/L .. | Face External Grooving Tool Holders               | Axial Stechhalter                          | 164             |
| ADKT-SWC-R/L ..   | External Grooving Tool Holders                    | Außen - Stechhalter                        | 157             |
| ADKT-TD-R/L ..    | External Grooving Tool Holders                    | Außen - Stechhalter                        | 152             |
| ADKT-TD-R/L ..-S  | External Grooving (Swiss Type) Tool Holders       | Außen - Stechhalter (Swiss Type)           | 158             |
| ADKT-TD-R/L..-H   | External Grooving Tool Holders With Coolant Tools | Externe Nutwerkzeughalter Mit Kühlwerkzeug | 152             |
| ADKT-TG-R/L ..    | External Grooving Tool Holders                    | Außen - Stechhalter                        | 155             |
| ADKT-TGF-R/L ..   | External Grooving Tool Holders                    | Außen - Stechhalter                        | 155             |
| ADKT-TG-R/L .. -S | External Grooving (Swiss Type) Tool Holders       | Außen - Stechhalter (SwissType)            | 161             |
| ADKT-WGX..R/L ..  | External Grooving Tool Holders                    | Außen - Stechhalter                        | 156             |
| ADKT-WGX..R/L ..S | External Grooving (Swiss Type) Tool Holders       | Außen - Stechhalter (SwissType)            | 161             |
| ADKT-ZCC1-R/L ..  | External Grooving Tool Holders                    | Außen - Stechhalter                        | 145             |
| ADKT-ZCC2-R/L ..  | External Grooving Tool Holders                    | Außen - Stechhalter                        | 146             |
| ADKT-ZCC2-R/L ..S | External Grooving (Swiss Type) Tool Holders       | Außen - Stechhalter (SwissType)            | 159             |
| AEKR/L ..         | Economic Cutting Tools                            | Multifunktionales Werkzeug                 | 224             |
| AEM90-3P..        | End Mills   | Schafffräser                               | 266             |
| AEM90-3P..        | Modular End Mills                                 | Einschraubfräser                           | 287             |
| AEM90-4N..        | End Mills   | Schafffräser                               | 266             |
| AEM90-AD..        | End Mills   | Schafffräser                               | 240             |
| AEM90-AD..        | Modular End Mills                                 | Einschraubfräser                           | 282             |
| AEM90-AN..        | End Mills   | Schafffräser                               | 242             |
| AEM90-AO..        | End Mills   | Schafffräser                               | 249             |
| AEM90-AO..        | Modular End Mills                                 | Einschraubfräser                           | 283             |
| AEM90-AP..        | End Mills   | Schafffräser                               | 244             |
| AEM90-AP..        | Modular End Mills                                 | Einschraubfräser                           | 283             |
| AEM90-AX..        | End Mills   | Schafffräser                               | 250             |
| AEM90-AX..        | Modular End Mills                                 | Einschraubfräser                           | 282             |
| AEM90-AZ..        | End Mills   | Schafffräser                               | 252             |
| AEM90-BD..        | End Mills   | Schafffräser                               | 253             |
| AEM90-BD.. -H     | Modular End Mills ( Screw Type Tools )            | Einschraubfräser                           | 253             |
| AEM90-DC..        | Modular End Mills                                 | Einschraubfräser                           | 284             |
| AEM90-ED..        | End Mills   | Schafffräser                               | 254             |
| AEM90-LO-H..      | End Mills   | Schafffräser                               | 256             |
| AEM90-LO          | End Mills   | Schafffräser                               | 257             |
| AEM90-LN..        | End Mills   | Schafffräser                               | 255             |
| AEM90-R390..      | End Mills   | Schafffräser                               | 257             |
| AEM90-R390..      | Modular End Mills                                 | Einschraubfräser                           | 258             |
| AEM90-RT..        | End Mills   | Schafffräser                               | 258             |
| AEM90-RT..        | Modular End Mills                                 | Einschraubfräser                           | 285             |
| AEM90-SE..        | End Mills   | Schafffräser                               | 259             |
| AEM90-SO..        | End Mills   | Schafffräser                               | 259             |
| AEM90-SPGT..      | End Mills   | Schafffräser                               | 261             |
| AEM90-TNG..       | End Mills   | Schafffräser                               | 286             |
| AEM90-TNG.. -H    | Modular End Mills ( Screw Type Tools )            | Einschraubfräser                           | 260             |
| AEM90-VC2205.. -H | End Mills   | Schafffräser                               | 261             |

| KOD / CODE     | AÇIKLAMA / DESCRIPTION                 | BESCHREIBUNG                         | S.N. / PN. SEITE | KOD / CODE        | AÇIKLAMA / DESCRIPTION      | BESCHREIBUNG                 | S.N. / PN. SEITE |
|----------------|--|--------------------------------------|------------------|-------------------|-----------------------------|------------------------------|------------------|
| AEM90-WN..     | End Mills                              | Schaftfräser                         | 262              | AFM88-SN..        | Face Milling                | Plan-und Eckmesserköpfe      | 325              |
| AEM90-WN..     | Modular End Mills                      | Einschraubfräser                     | 262              | AFM89-SN..        | Face Milling                | Plan-und Eckmesserköpfe      | 328              |
| AEM90-WNG.. -H | End Mills                              | Schaftfräser                         | 262              | AFM90(L)-LN..     | Face Milling                | Plan-und Eckmesserköpfe      | 335              |
| AEM90-XC..     | End Mills                              | Schaftfräser                         | 263              | AFM90(S)-SD..     | Face Milling                | Plan-und Eckmesserköpfe      | 342              |
| AEM90-XD..     | End Mills                              | Schaftfräser                         | 263              | AFM90-3P..        | Face Milling                | Plan-und Eckmesserköpfe      | 350              |
| AEM90-XN..-H   | Modular End Mills ( Screw Type Tools ) | Einschraubfräser                     | 287              | AFM90-490..       | Face Milling                | Plan-und Eckmesserköpfe      | 341              |
| AEM90-XN..     | End Mills                              | Schaftfräser                         | 264              | AFM90-4N..        | Face Milling                | Plan-und Eckmesserköpfe      | 350              |
| AEM90-XO..     | End Mills                              | Schaftfräser                         | 264              | AFM90-6N..        | Face Milling                | Plan-und Eckmesserköpfe      | 351              |
| AEM90-ZC..     | End Mills                              | Schaftfräser                         | 265              | AFM90-AD..        | Face Milling                | Plan-und Eckmesserköpfe      | 329              |
| AEM90-ZP..     | End Mills                              | Schaftfräser                         | 265              | AFM90-AN..        | Face Milling                | Plan-und Eckmesserköpfe      | 330              |
| AEM95(C)-XD..  | Modular End Mills                      | Einschraubfräser                     | 288              | AFM90-AO..        | Face Milling                | Plan-und Eckmesserköpfe      | 335              |
| AEMR(C)-RD..   | Face and Copy End Mills                | Kopier - und Schaftfräser            | 269              | AFM90-AP..        | Face Milling                | Plan-und Eckmesserköpfe      | 332              |
| AEMR-QP..      | Face and Copy Mills                    | Kopier - und Schaftfräser            | 270              | AFM90-AX..        | Face Milling                | Plan-und Eckmesserköpfe      | 333              |
| AEMR-QP..      | Modular End Mills                      | Einschraubfräser                     | 293              | AFM90-BD..        | Face Milling                | Plan-und Eckmesserköpfe      | 334              |
| AEMR-RC..      | Modular End Mills                      | Einschraubfräser                     | 291              | AFM90C-TP..       | Face Milling                | Plan-und Eckmesserköpfe      | 359              |
| AEMR-RD..      | Face and Copy Mills                    | Kopier - und Schaftfräser            | 269              | AFM90-LO..        | Face Milling                | Plan-und Eckmesserköpfe      | 339              |
| AEMR-RD..      | Modular End Mills                      | Einschraubfräser                     | 291              | AFM90-LO..-H      | Face Milling                | Plan-und Eckmesserköpfe      | 334              |
| AEMR-RP..      | Face and Copy Mills                    | Kopier - und Schaftfräser            | 267              | AFM90-R290..      | Face Milling                | Plan-und Eckmesserköpfe      | 340              |
| AEMR-RP..      | Modular End Mills                      | Einschraubfräser                     | 289              | AFM90-R390..      | Face Milling                | Plan-und Eckmesserköpfe      | 340              |
| AEMR-RP..      | Modular End Mills ( Screw Type Tools ) | Einschraubfräser                     | 292              | AFM90-RT..        | Face Milling                | Plan-und Eckmesserköpfe      | 341              |
| AEMR-RY..      | Face and Copy End Mills                | Kopier - und Schaftfräser            | 268              | AFM90-SE..        | Face Milling                | Plan-und Eckmesserköpfe      | 343              |
| AEMR-RY..      | Modular End Mills                      | Einschraubfräser                     | 290              | AFM90-SP..        | Face Milling                | Plan-und Eckmesserköpfe      | 344              |
| AEMRC-RD..     | Modular End Mills ( Screw Type Tools ) | Einschraubfräser                     | 290              | AFM90-TN..        | Face Milling                | Plan-und Eckmesserköpfe      | 345              |
| AET            | Eccentric Adaptör For U-Drill          | Exzentrischer Adapter für Vollbohrer | 220              | AFM90-TP..        | Face Milling                | Plan-und Eckmesserköpfe      | 346              |
| AFM40-NN..     | Face Milling                           | Plan-und Eckmesserköpfe              | 315              | AFM90-VC2205.. -H | Face Milling                | Plan-und Eckmesserköpfe      | 347              |
| AFM42C-XD..    | Face Milling                           | Plan-und Eckmesserköpfe              | 312              | AFM90-WN..        | Face Milling                | Plan-und Eckmesserköpfe      | 348              |
| AFM43(C)-OD..  | Face Milling                           | Plan-und Eckmesserköpfe              | 312              | AFM90-WNG0.. -H   | Face Milling                | Plan-und Eckmesserköpfe      | 347              |
| AFM43(C)-OF..  | Face Milling                           | Plan-und Eckmesserköpfe              | 313              | AFM90-XN..        | Face Milling                | Plan-und Eckmesserköpfe      | 349              |
| AFM43-ON..     | Face Milling                           | Plan-und Eckmesserköpfe              | 314              | AFM90-XO..        | Face Milling                | Plan-und Eckmesserköpfe      | 349              |
| AFM44-ON..     | Face Milling                           | Plan-und Eckmesserköpfe              | 314              | AFMR(C)-RD..      | Face and Copy Milling       | Kopier - und Schaftfräser    | 353              |
| AFM45(L)-HN..  | Face Milling                           | Plan-und Eckmesserköpfe              | 315              | AFMR(C)-RO..      | Face and Copy Milling       | Kopier - und Schaftfräser    | 354              |
| AFM45(L)-SE..  | Face Milling                           | Plan-und Eckmesserköpfe              | 316              | AFMR-QP..         | Face and Copy Milling       | Kopier - und Schaftfräser    | 356              |
| AFM45(S)-SE    | Face Milling                           | Plan-und Eckmesserköpfe              | 316              | AFMR-RC..         | Face and Copy Milling       | Kopier - und Schaftfräser    | 352              |
| AFM45-SE..     | Face Milling                           | Plan-und Eckmesserköpfe              | 317              | AFMR-RP..         | Face and Copy Milling       | Kopier - und Schaftfräser    | 355              |
| AFM45C(L)-HN.. | Face Milling                           | Plan-und Eckmesserköpfe              | 357              | AFMR-RY..         | Face and Copy Milling       | Kopier - und Schaftfräser    | 255              |
| AFM45C(L)-SN.. | Face Milling                           | Plan-und Eckmesserköpfe              | 319              | AHFM(C)-JD..      | High Feed Milling Tools     | Hochvorschubfräser           | 297              |
| AFM45C-ON..    | Face Milling                           | Plan-und Eckmesserköpfe              | 322              | AHFM(C)-SD..      | High Feed End Mills         | Hochvorschubschaftfräser     | 366              |
| AFM45C-XN..    | Face Milling                           | Plan-und Eckmesserköpfe              | 357              | AHFM(C)-SD..      | High Feed Milling Tools     | Hochvorschubfräser           | 279              |
| AFM45-NN..     | Face Milling                           | Plan-und Eckmesserköpfe              | 316              | AHFM(C)-SD..      | Modular High Feed End Mills | Hochvorschubeinschraubfräser | 299              |
| AFM45-ON..     | Face Milling                           | Plan-und Eckmesserköpfe              | 321              | AHFM(C)-WD..      | High Feed End Mills         | Hochvorschubschaftfräser     | 279              |
| AFM45S-SE..    | Face Milling                           | Plan-und Eckmesserköpfe              | 318              | AHFM(C)-WD..      | High Feed Milling Tools     | Hochvorschubfräser           | 280              |
| AFM45-SA..     | Face Milling                           | Plan-und Eckmesserköpfe              | 320              | AHFM(L)-WN..      | High Feed Milling Tools     | Hochvorschubfräser           | 361              |
| AFM45-SN..     | Face Milling                           | Plan-und Eckmesserköpfe              | 323              | AHFM-BL..         | High Feed End Mills         | Hochvorschubschaftfräser     | 276              |
| AFM45-XN..     | Face Milling                           | Plan-und Eckmesserköpfe              | 322              | AHFM-BL..         | High Feed Milling Tools     | Hochvorschubfräser           | 360              |
| AFM66-PN..     | Face Milling                           | Plan-und Eckmesserköpfe              | 323              | AHFM-BL..         | Modular High Feed End Mills | Hochvorschubfräser           | 293              |
| AFM67-PN..     | Face Milling                           | Plan-und Eckmesserköpfe              | 324              | AHFM-BN..         | High Feed End Mills         | Hochvorschubschaftfräser     | 270              |
| AFM75-AP..     | Face Milling                           | Plan-und Eckmesserköpfe              | 324              | AHFMC-JD..        | High Feed End Mills         | Hochvorschubschaftfräser     | 364              |
| AFM75C-SP..    | Face Milling                           | Plan-und Eckmesserköpfe              | 358              | AHFMC-JD..        | Modular High Feed End Mills | Hochvorschubfräser           | 297              |
| AFM75-XO..     | Face Milling                           | Plan-und Eckmesserköpfe              | 325              | AHFMC-WD..        | Modular High Feed End Mills | Hochvorschubfräser           | 302              |
| AFM88C-SN..    | Face Milling                           | Plan-und Eckmesserköpfe              | 326              | AHFM-ED..         | Modular High Feed End Mills | Hochvorschubfräser           | 294              |

| KOD / CODE         | AÇIKLAMA / DESCRIPTION                    | BESCHREIBUNG                 | S.N. / P.N. SEITE |
|--------------------|---|------------------------------|-------------------|
| AHFM-EN..          | High Feed End Mills                       | Hochvorschubschafffräser     | 273               |
| AHFM-EN..          | High Feed Milling Tools                   | Hochvorschubfräser           | 360               |
| AHFM-EN..          | Modular High Feed End Mills               | Hochvorschubfräser           | 295               |
| AHFM-EO..          | High Feed End Mills                       | Hochvorschubschafffräser     | 271               |
| AHFM-EP..          | High Feed End Mills                       | Hochvorschubschafffräser     | 271               |
| AHFM-EP..          | High Feed Milling Tools                   | Hochvorschubfräser           | 271               |
| AHFM-EP..          | Modular High Feed End Mills               | Hochvorschubfräser           | 294               |
| AHFM-JD..          | High Feed Milling Tools                   | Hochvorschubfräser           | 362               |
| AHFM-JD..          | Modular High Feed End Mills               | Hochvorschubfräser           | 296               |
| AHFM-LN..          | High Feed End Mills                       | Hochvorschubschafffräser     | 275               |
| AHFM-LN..          | Modular High Feed End Mills               | Hochvorschubfräser           | 295               |
| AHFM-LN0303.. -H   | Modular End Mills                         | Einschraubfräser             | 362               |
| AHFM-LN0303.. -H   | Modular ( Screw Type ) Highfeed End Mills | Einschraubfräser             | 295               |
| AHFM-LN0303.. -H   | High Feed Milling Tools                   | Hochvorschubfräser           | 275               |
| AHFM-LO..          | High Feed End Mills                       | Hochvorschubschafffräser     | 275               |
| AHFM-LO..          | High Feed Milling Tools                   | Hochvorschubfräser           | 361               |
| AHFM-LO..          | Modular High Feed End Mills               | Hochvorschubeinschraubfräser | 296               |
| AHFM-LP..          | High Feed End Mills                       | Hochvorschubschafffräser     | 276               |
| AHFM-SD..          | Modular High Feed End Mills               | Hochvorschubfräser           | 297               |
| AHFM-SO..          | High Feed End Mills                       | Hochvorschubschafffräser     | 277               |
| AHFM-SO..          | High Feed Milling Tools                   | Hochvorschubschafffräser     | 365               |
| AHFM-SO..          | Modular High Feed End Mills               | Hochvorschubfräser           | 300               |
| AHFM-SP..          | High Feed End Mills                       | Hochvorschubschafffräser     | 274               |
| AHFM-SP..          | High Feed Milling Tools                   | Hochvorschubfräser           | 363               |
| AHFM-SP..          | Modular High Feed End Mills               | Hochvorschubfräser           | 298               |
| AHFM-SP-H..        | High Feed End Mills                       | Hochvorschubschafffräser     | 274               |
| AHFM-WN..          | High Feed End Mills                       | Hochvorschubschafffräser     | 280               |
| AHFM-WN..          | Modular High Feed End Mills               | Hochvorschubfräser           | 281               |
| AHFM-WO..          | High Feed End Mills                       | Hochvorschubschafffräser     | 281               |
| AHFM-YO..          | High Feed End Mills                       | Hochvorschubschafffräser     | 279               |
| AHFM-YP..          | High Feed End Mills                       | Hochvorschubschafffräser     | 278               |
| AHFM-YP..          | Modular High Feed End Mills               | Hochvorschubfräser           | 301               |
| AHFM-JO..          | High Feed End Mills                       | Hochvorschubschafffräser     | 363               |
| AHM ..             | Helix Chamfer Milling Tools               | Helix-Fasfräser              | 238               |
| AHM90-AP..         | Helix End Mills                           | Wendelschafffräser           | 311               |
| AHM90-AP1204.. -H  | Helix End Mills                           | Wendelschafffräser           | 310               |
| AIKT-123..-R/L ..  | Internal Grooving Tool Holders            | Innen - Stechhalter          | 176               |
| AIKT-151..-R/L ..  | Internal Grooving Tool Holders            | Innen - Stechhalter          | 176               |
| AIKT-154.91-R/L .. | Internal Grooving Tool Holders            | Innen - Stechhalter          | 177               |
| AIKT-GP-R/L ..     | Internal Grooving Tool Holders            | Innen - Stechhalter          | 181               |
| AIKT-HK-R/L ..     | Internal Grooving Tool Holders            | Innen - Stechhalter          | 189               |
| AIKT-H-R/L ..      | Internal Grooving Tool Holders            | Innen - Stechhalter          | 174               |
| AIKT-HS223-R/L ..  | Internal Grooving Tool Holders            | Innen - Stechhalter          | 175               |
| AIKT-IGE-R/L ..    | Internal Grooving Tool Holders            | Innen - Stechhalter          | 178               |
| AIKT-IGI-R/L ..    | Internal Grooving Tool Holders            | Innen - Stechhalter          | 179               |
| AIKT-IG-R/L ..     | Internal Grooving Tool Holders            | Innen - Stechhalter          | 180               |
| AIKT-I-R/L ..      | Internal Grooving Tool Holders            | Innen - Stechhalter          | 179               |
| AIKT-ITG-R/L ..    | Internal Grooving Tool Holders            | Innen - Stechhalter          | 180               |
| AIKT-KG-R/L ..     | Internal Grooving Tool Holders            | Innen - Stechhalter          | 174               |
| AIKT-KM-R/L ..     | Internal Grooving Tool Holders            | Innen - Stechhalter          | 175               |

| KOD / CODE          | AÇIKLAMA / DESCRIPTION                  | BESCHREIBUNG                                      | S.N. / P.N. SEITE |
|---------------------|---|---|-------------------|
| AIKT-K-R/L ..       | Internal Grooving Tool Holders          | Innen - Stechhalter                               | 173               |
| AIKT-MB..           | Mini Grooving Tool                      | Mini - Stechwerkzeuge                             | 183               |
| AIKT-QC..-R/L ..    | Internal Grooving Tool Holders          | Innen - Stechhalter                               | 182               |
| AIKT-RD-R/L ..      | Internal Grooving Tool Holders          | Innen - Stechhalter                               | 177               |
| AIKT-SGC-R ..       | Internal Grooving Tool Holders          | Innen - Stechhalter                               | 183               |
| AIKT-TD-R/L ..      | Internal Grooving Tool Holders          | Innen - Stechhalter                               | 178               |
| AIKT-TG-R/L ..      | Internal Grooving Tool Holders          | Innen - Stechhalter                               | 181               |
| AIKT-ZCC2-R/L ..    | Internal Grooving Tool Holders          | Innen - Stechhalter                               | 182               |
| AKCR ..             | Adjustable Rough Boring Heads Cartridge | Einstellbare Schrupp - Spindelkopf Kurzdrehhalter | 233               |
| AKL-123 ..          | Blades                                  | Stechschwert                                      | 167               |
| AKL-K ..            | Blades                                  | Stechschwert                                      | 168               |
| AKL-SP ..           | Blades                                  | Stechschwert                                      | 169               |
| AKL-SX ..           | Blades                                  | Stechschwert                                      | 169               |
| AKL-ZCC2 ..         | Blades                                  | Stechschwert                                      | 168               |
| AKL-I ..            | Blades                                  | Stechschwert                                      | 167               |
| AKL-SGC ..          | Blades                                  | Stechschwert                                      | 166               |
| AKL-TD ..           | Blades                                  | Stechschwert                                      | 166               |
| AKSR ..             | Adjustable Rough Boring Heads Cartridge | EINSTELLBARE SPINDEL-KÖPFE                        | 233               |
| ALBU ..             | Blocks For Blades                       | Spannblock für Stechschwert                       | 170               |
| ALBU-H ..           | Blocks For Blades                       | Spannblock für Stechschwert                       | 170               |
| ALKT-ZCC2-R/L ..    | Face External Grooving Tool Holders     | Axial Stechhalter                                 | 165               |
| APMR-BNM..          | Ball Nose End Mills                     | Kopier-Schafffräser                               | 304               |
| APMR-BNM.. -H       | Modular ( Screw Type ) End Mills        | Einschraubfräser                                  | 306               |
| APMR-P32..          | Ball Nose End Mills                     | Kopier-Schafffräser                               | 305               |
| APMR-P32..          | Ball Nose Modular End Mills             | Modulare Einschraub - Kugelfräser                 | 306               |
| APMR-RO..           | Ball Nose End Mills                     | Kopier-Schafffräser                               | 304               |
| APMR-SWB..          | Ball Nose Modular End Mills             | Modulare Einschraub - Kugelfräser                 | 307               |
| APMR-XP..           | Ball Nose End Mills                     | Kopier-Schafffräser                               | 305               |
| APMR-XP..           | Ball Nose Modular End Mills             | Modulare Einschraub - Kugelfräser                 | 307               |
| ASDM-CC..           | Disc Milling                            | Scheibenfräser                                    | 372               |
| ASDM-SPGT..         | Disc Milling                            | Scheibenfräser                                    | 371               |
| ASTB-..             | Swiss Easy Change Tools                 | Swiss Easy Change Tools                           | 70                |
| ATM..               | Thread Milling Tools                    | Gewindefräswerkzeuge                              | 308               |
| ATM-3BEI..          | Thread Milling Tools                    | Gewindefräswerkzeuge                              | 309               |
| ATM60..             | Thread Milling Tools                    | Gewindefräswerkzeuge                              | 310               |
| ATSM90-CC..         | T Slot Milling                          | T Nutenfräser                                     | 369               |
| ATSM90-SP..         | T Slot Milling                          | T Nutenfräser                                     | 370               |
| ATSMR-RD..          | T Slot Milling                          | T Nutenfräser                                     | 370               |
| ATTB ..             | Anti Vibration Tool                     | Schwingungsgedämpfte Bohrstangen                  | 115               |
| ATTC ..             | Anti Vibration Tool                     | Schwingungsgedämpfte Bohrstangen                  | 116               |
| ATTC- .. SCLCR/L .. | Anti Vibration Tool                     | Schwingungsgedämpfte Bohrstangen                  | 116               |
| ATTC- .. SDUCR/L .. | Anti Vibration Tool                     | Schwingungsgedämpfte Bohrstangen                  | 132               |
| ATTC- .. SVUCR/L .. | Anti Vibration Tool                     | Schwingungsgedämpfte Bohrstangen                  | 117               |
| ATTC- .. TCLNR/L .. | Anti Vibration Tool                     | Schwingungsgedämpfte Bohrstangen                  | 118               |



| KOD / CODE          | AÇIKLAMA / DESCRIPTION | BESCHREIBUNG                      | S.N. / P.N. SEITE | KOD / CODE     | AÇIKLAMA / DESCRIPTION                          | BESCHREIBUNG                        | S.N. / P.N. SEITE |
|---------------------|------------------------|-----------------------------------|-------------------|----------------|---|-------------------------------------|-------------------|
| ATTC- .. TDUNR/L .. | Anti Vibration Tool    | Schwingungsgedämpfte Bohrstrangen | 117               | MTQNR/L ..     | Internal Tool Holders                           | Außen-Drehhalter                    | 86                |
| ATUM .. xD2 KDR ..  | U-Drill                | Vollbohrer                        | 210               | MTUNR/L ..     | Internal Tool Holders                           | Außen-Drehhalter                    | 86                |
| ATUM .. xD2 SP ..   | U-Drill                | Vollbohrer                        | 195               | MWLNRL ..      | External Tool Holders                           | Außen-Drehhalter                    | 31                |
| ATUM .. xD2 SPGT .. | U-Drill                | Vollbohrer                        | 201               | MwLNRL ..      | Internal Tool Holders                           | Außen-Drehhalter                    | 87                |
| ATUM .. xD2 WCM ..  | U-Drill                | Vollbohrer                        | 188               | MWMNN ..       | External Tool Holders                           | Außen-Drehhalter                    | 31                |
| ATUM .. xD3 KDR ..  | U-Drill                | Vollbohrer                        | 211               | PCBNR/L ..     | External Tool Holders                           | Außen-Drehhalter                    | 33                |
| ATUM .. xD3 SO ..   | U-Drill                | Vollbohrer                        | 208               | PCLNR/L ..     | External Tool Holders                           | Außen-Drehhalter                    | 33                |
| ATUM .. xD3 SP ..   | U-Drill                | Vollbohrer                        | 198               | PCLNR/L ..     | Internal Tool Holders                           | Außen-Drehhalter                    | 89                |
| ATUM .. xD3 SPGT .. | U-Drill                | Vollbohrer                        | 202               | PCLNR/L.. -H   | External Turning Toolholders With Coolant Tools | Außen-Drehhalter INNENKÜHLUNG       | 34                |
| ATUM .. xD3 WCM ..  | U-Drill                | Vollbohrer                        | 190               | PCMNN ..       | External Tool Holders                           | Außen-Drehhalter                    | 34                |
| ATUM .. xD4 KDR ..  | U-Drill                | Vollbohrer                        | 210               | PDJNR/L ..     | External Tool Holders                           | Außen-Drehhalter                    | 35                |
| ATUM .. xD4 SO ..   | U-Drill                | Vollbohrer                        | 209               | PDJNR/L .. -H  | External Turning Toolholders With Coolant Tools | Außen-Drehhalter INNENKÜHLUNG       | 35                |
| ATUM .. xD4 SP ..   | U-Drill                | Vollbohrer                        | 199               | PDNNN ..       | External Tool Holders                           | Außen-Drehhalter                    | 36                |
| ATUM .. xD4 SPGT .. | U-Drill                | Vollbohrer                        | 204               | PDNNN-H        | External Turning Toolholders With Coolant Tools | Außen-Drehhalter INNENKÜHLUNG       | 36                |
| ATUM .. xD4 WCM ..  | U-Drill                | Vollbohrer                        | 192               | PDQNR/L ..     | Internal Tool Holders                           | Außen-Drehhalter                    | 90                |
| ATUM .. xD5 SP ..   | U-Drill                | Vollbohrer                        | 200               | PDUNR/L ..     | Internal Tool Holders                           | Außen-Drehhalter                    | 91                |
| ATUM .. xD5 WCM ..  | U-Drill                | Vollbohrer                        | 194               | PDXNR/L ..     | Internal Tool Holders                           | Außen-Drehhalter                    | 90                |
| ATUM xD2 SO ..      | U-Drill                | Vollbohrer                        | 207               | PSBNR/L ..     | External Tool Holders                           | Außen-Drehhalter                    | 37                |
| ATUM xD2 SOMT ..    | U-Drill                | Vollbohrer                        | 212               | PSDNN ..       | Cartridge                                       | Kassette                            | 130               |
| ATUM xD3 880 ..     | U-Drill                | Vollbohrer                        | 216               | PSDNN ..       | External Tool Holders                           | Außen-Drehhalter                    | 37                |
| ATUM xD3 SO ..      | U-Drill                | Vollbohrer                        | 208               | PSKNR/L ..     | Cartridge                                       | Kassette                            | 128               |
| ATUM xD3 SOMT ..    | U-Drill                | Vollbohrer                        | 213               | PSKNR/L ..     | External Tool Holders                           | Außen-Drehhalter                    | 38                |
| ATUM xD4 SO ..      | U-Drill                | Vollbohrer                        | 209               | PSKNR/L ..     | Internal Tool Holders                           | Außen-Drehhalter                    | 92                |
| ATUM xD4 SOMT ..    | U-Drill                | Vollbohrer                        | 214               | PSRNR/L ..     | Cartridge                                       | Kassette                            | 129               |
| ATUM xD5 SOMT ..    | U-Drill                | Vollbohrer                        | 215               | PSSNR/L ..     | External Tool Holders                           | Außen-Drehhalter                    | 38                |
| ATUM xD5 SPGT ..    | U-Drill                | Vollbohrer                        | 204               | PTFNR/L ..     | Cartridge                                       | Kassette                            | 129               |
| AVTT..              | Screwed Tool Holders   | Aufnahme für Einschraubfräser     | 308               | PTFNR/L ..     | External Tool Holders                           | Außen-Drehhalter                    | 39                |
| CCLNR/L ..          | External Tool Holders  | Außen-Drehhalter                  | 45                | PTGNR/L ..     | External Tool Holders                           | Außen-Drehhalter                    | 39                |
| CDJNR/L ..          | External Tool Holders  | Außen-Drehhalter                  | 46                | PTGNR/L ..     | Cartridge                                       | Kassette                            | 129               |
| CDNNN ..            | External Tool Holders  | Außen-Drehhalter                  | 46                | PTJNR/L ..     | External Tool Holders                           | Außen-Drehhalter                    | 40                |
| CKJNR/L ..          | External Tool Holders  | Außen-Drehhalter                  | 45                | PTTNR/L ..     | External Tool Holders                           | Außen-Drehhalter                    | 40                |
| CKUNR/L ..          | Internal Tool Holders  | Außen-Drehhalter                  | 98                | PTUNR/L ..     | Internal Tool Holders                           | Außen-Drehhalter                    | 93                |
| CRDCN ..            | External Tool Holders  | Außen-Drehhalter                  | 47                | PwLNRL ..      | External Tool Holders                           | Außen-Drehhalter                    | 41                |
| CRDCR/L ..          | External Tool Holders  | Außen-Drehhalter                  | 48                | PwLNRL ..      | Internal Tool Holders                           | Außen-Drehhalter                    | 94                |
| CSDNN ..            | External Tool Holders  | Außen-Drehhalter                  | 48                | PwLNRL/L .. -H | External Turning Toolholders With Coolant Tools | Interne Kühlung Aussen - Drehhalter | 41                |
| CSKNR/L ..          | External Tool Holders  | Außen-Drehhalter                  | 49                | PDJCR/L.. -H   | External Tool Holders Swiss Type                | Außen-Drehhalter Swiss Type         | 42                |
| CSRNR/L ..          | External Tool Holders  | Außen-Drehhalter                  | 49                | S/SCLCR/L ..   | Boring Bars SET                                 | Bohrstangen Set                     | 111               |
| CSSNR/L ..          | External Tool Holders  | Außen-Drehhalter                  | 50                | S/SDUCR/L ..   | Boring Bars SET                                 | Bohrstangen Set                     | 112               |
| CTFPR/L ..          | Boring Bars            | Bohrstangen                       | 82                | SCACR/L ..     | Engine Overhaul Cartridge                       | Motorüberholungskassette            | 123               |
| CTJNR/L ..          | External Tool Holders  | Außen-Drehhalter                  | 50                | SCACR/L ..     | External Tool Holders                           | Außen-Drehhalter                    | 51                |
| E/SCLCR/L ..        | Boring Bars SET        | Bohrstangen Set                   | 111               | SCACR/L ..-S   | External Tool Holders Swiss Type                | Außen-Drehhalter Swiss Type         | 66                |
| E/SDUCR/L ..        | Boring Bars SET        | Bohrstangen Set                   | 112               | SCFCR/L        | Spare Parts Of Cartridge                        | Ersatzteile für Kassette            | 130               |
| E/STFCR/L ..        | Boring Bars            | Bohrstangen                       | 112               | SCFCR/L ..     | Cartridge                                       | Kassette                            | 125               |
| E/STUPR/L ..        | Boring Bars            | Bohrstangen                       | 110               | SCFCR/L ..     | Internal Tool Holders                           | Außen-Drehhalter                    | 97                |
| MCLNR/L ..          | Internal Tool Holders  | Außen-Drehhalter                  | 84                | SCLCR/L ..     | Boring Bars With Carbide Shank                  | Bohrstangen mit Hartmetall-schaft   | 109               |
| MDUNR/L ..          | Internal Tool Holders  | Außen-Drehhalter                  | 84                | SCLCR/L ..     | External Tool Holders                           | External Tool Holders               | 52                |
| MTENN ..            | External Tool Holders  | Außen-Drehhalter                  | 30                | SCLCR/L ..-SHP | External Tool Holders                           | External Tool Holders               | 53                |
| MTFNR/L ..          | Internal Tool Holders  | Außen-Drehhalter                  | 85                | SCLCR/L ..     | Internal Tool Holders                           | Außen-Drehhalter                    | 96                |
| MTJNR/L ..          | External Tool Holders  | Außen-Drehhalter                  | 30                |                |   |                                     |                   |
| MT-NR/L ..          | Internal Tool Holders  | Außen-Drehhalter                  | 85                |                |   |                                     |                   |

| KOD / CODE     | AÇIKLAMA / DESCRIPTION           | BESCHREIBUNG                     | S.N. / P.N. SEITE |
|----------------|----------------------------------|----------------------------------|-------------------|
| SCLCR/L ..-S   | External Tool Holders Swiss Type | Außen-Drehhalter Swiss Type      | 66                |
| SCMCN ..       | Engine Overhaul Cartridge        | Хонингованные Kasette            | 124               |
| SCMCN ..       | External Tool Holders            | Außen-Drehhalter                 | 53                |
| SCSCR/L        | Spare Parts Of Cartridge         | Ersatzteile für Kasette          | 130               |
| SCSCR/L ..     | Cartridge                        | Kasette                          | 126               |
| SDACR/L ..-S   | External Tool Holders Swiss Type | Außen-Drehhalter Swiss Type      | 67                |
| SD-CR/L ..     | Internal Tool Holders            | Außen-Drehhalter                 | 97                |
| SDHCR/L ..     | External Tool Holders            | Außen-Drehhalter                 | 54                |
| SDJCR/L ..     | External Tool Holders            | Außen-Drehhalter                 | 54                |
| SDJCR/L ..     | Sec Tools                        | Sec Tools                        | 71                |
| SDJCR/L ..-S   | External Tool Holders Swiss Type | Außen-Drehhalter Swiss Type      | 67                |
| SDJCR/L ..-SHP | External Tool Holders            | Außen-Drehhalter                 | 55                |
| SDJCR/L ..     | Swiss Easy Change Tools          | Swiss Easy Change Tools          | 71                |
| SDNCN ..       | External Tool Holders            | Außen-Drehhalter                 | 55                |
| SDPCR/L ..     | Internal Tool Holders            | Außen-Drehhalter                 | 98                |
| SDQCR/L ..     | Internal Tool Holders            | Außen-Drehhalter                 | 98                |
| SDUCR/L ..     | Boring Bars With Carbide Shank   | Bohrstangen mit Hartmetallschaft | 109               |
| SDUCR/L ..     | Internal Tool Holders            | Außen-Drehhalter                 | 99                |
| SDXCR/L ..     | Internal Tool Holders            | Außen-Drehhalter                 | 100               |
| SER/L ..       | External Threading Tool Holders  | Sec Tools                        | 134               |
| SER/L ..       | Sec Tools                        | Sec Tools                        | 72                |
| SIR/L ..       | Internal Threading Tool Holders  | Werkzeughalter für Innengewinde  | 135               |
| SRDCN ..       | External Tool Holders            | Außen-Drehhalter                 | 56                |
| SRDCR/L ..     | External Tool Holders            | Außen-Drehhalter                 | 57                |
| SRGCR/L ..     | External Tool Holders            | Außen-Drehhalter                 | 57                |
| SRGCR/L ..     | Internal Tool Holders            | Außen-Drehhalter                 | 101               |
| SRHCR/L ..     | External Tool Holders            | Außen-Drehhalter                 | 58                |
| SRSCN..        | Engine Overhaul Cartridge        | Motorüberholungskasette          | 124               |
| SRXCR/L ..     | External Tool Holders            | Außen-Drehhalter                 | 58                |
| SSDCN ..       | External Tool Holders            | Außen-Drehhalter                 | 59                |
| SSKCR/L ..     | Cartridge                        | Kasette                          | 126               |
| SSSCR/L ..     | External Tool Holders            | Außen-Drehhalter                 | 59                |
| SSSCR/L ..     | Internal Tool Holders            | Außen-Drehhalter                 | 101               |
| STCCN ..       | External Tool Holders            | Außen-Drehhalter                 | 61                |
| ST-CR/L ..     | Internal Tool Holders            | Außen-Drehhalter                 | 102               |
| STFCR/L        | Spare Parts Of Cartridge         | Ersatzteile für Kasette          | 130               |
| STFCR/L ..     | Cartridge                        | Kasette                          | 127               |
| STFCR/L ..     | External Tool Holders            | Außen-Drehhalter                 | 60                |
| STFCR/L ..     | Internal Tool Holders            | Außen-Drehhalter                 | 102               |
| STFPR/L ..     | Finish Boring Heads Cartridge    | FERTIGBOHRKÖPFE UND KARTUSCHEN   | 229               |
| STGCR/L ..     | External Tool Holders            | Außen-Drehhalter                 | 60                |
| STGCR/L ..-S   | External Tool Holders Swiss Type | Außen-Drehhalter Swiss Type      | 68                |
| STJCR/L ..     | External Tool Holders            | Außen-Drehhalter                 | 61                |
| STSCR/L        | Spare Parts Of Cartridge         | Ersatzteile für Kasette          | 130               |
| STSCR/L ..     | Cartridge                        | Kasette                          | 127               |
| STTCR/L        | Spare Parts Of Cartridge         | Ersatzteile für Kasette          | 130               |
| STTCR/L ..     | Cartridge                        | Kasette                          | 128               |
| STUCR/L ..     | External Tool Holders            | Außen-Drehhalter                 | 62                |
| STUCR/L ..     | Internal Tool Holders            | Außen-Drehhalter                 | 103               |
| STUPR/L ..     | Internal Tool Holders            | Außen-Drehhalter                 | 104               |

| KOD / CODE     | AÇIKLAMA / DESCRIPTION                          | BESCHREIBUNG                    | S.N. / P.N. SEITE |
|----------------|---|---------------------------------|-------------------|
| STUPR/L ..     | Finish Boring Heads Cartridge                   | FERTIGBOHRKÖPFE UND KARTUSCHEN  | 228               |
| STXCR/L ..     | Engine Overhaul Cartridge                       | Motorüberholungskasette         | 125               |
| SVACR/L ..-S   | External Tool Holders Swiss Type                | Außen-Drehhalter Swiss Type     | 69                |
| SVHBR/L ..     | External Tool Holders                           | Außen-Drehhalter                | 62                |
| SVHCR/L ..     | External Tool Holders                           | Außen-Drehhalter                | 63                |
| SVJBR/L ..     | External Tool Holders                           | Außen-Drehhalter                | 63                |
| SVJBR/L ..     | Internal Tool Holders                           | Außen-Drehhalter                | 104               |
| SVJBR/L ..-S   | External Tool Holders Swiss Type                | Außen-Drehhalter Swiss Type     | 69                |
| SVJCR/L        | Swiss Easy Change Tools                         | Swiss Easy Change Tools         | 71                |
| SVJCR/L ..     | External Tool Holders                           | Außen-Drehhalter                | 64                |
| SVJCR/L ..     | Internal Tool Holders                           | Außen-Drehhalter                | 107               |
| SVJCR/L ..     | Sec Tools                                       | Sec Tools                       | 71                |
| SVJCR/L ..-S   | External Tool Holders Swiss Type                | Außen-Drehhalter Swiss Type     | 70                |
| SVQBR/L ..     | Internal Tool Holders                           | Außen-Drehhalter                | 105               |
| SVQCR/L ..     | Internal Tool Holders                           | Außen-Drehhalter                | 105               |
| SVUBR/L ..     | Internal Tool Holders                           | Außen-Drehhalter                | 106               |
| SVUCR/L ..     | Internal Tool Holders                           | Außen-Drehhalter                | 106               |
| SVVBN ..       | External Tool Holders                           | Außen-Drehhalter                | 65                |
| SVVCN ..       | External Tool Holders                           | Außen-Drehhalter                | 65                |
| SVXBR/L ..     | Internal Tool Holders                           | Außen-Drehhalter                | 107               |
| SVJCR/L ..-SHP | External Tool Holders                           | Außen-Drehhalter                | 64                |
| SWLCR ..       | Internal Tool Holders                           | Außen-Drehhalter                | 108               |
| SWLCR ..       | Finish Boring Heads Cartridge                   | FERTIGBOHRKÖPFE UND KARTUSCHEN  | 228               |
| SWUBR ..       | Internal Tool Holders                           | Außen-Drehhalter                | 108               |
| TCBNR/L ..     | External Tool Holders                           | Außen-Drehhalter                | 13                |
| TCBNR/L ..-H   | External Tool Holders                           | Außen-Drehhalter                | 13                |
| TCKNR/L ..     | External Tool Holders                           | Außen-Drehhalter                | 14                |
| TCKNR/L ..-H   | External Tool Holders                           | Außen-Drehhalter                | 14                |
| TCLNR/L ..     | External Tool Holders                           | Außen-Drehhalter                | 15                |
| TCLNR/L ..-H   | External Tool Holders                           | Außen-Drehhalter                | 15                |
| TCLNR/L ..     | Internal Tool Holders                           | Außen-Drehhalter                | 77                |
| TCLNR/L .. -H  | External Turning Toolholders With Coolant Tools | Außen-Drehhalter INNENKÜHLUNG   | 15                |
| TCMNN ..       | External Tool Holders                           | Außen-Drehhalter                | 16                |
| TCZNN ..       | External Tool Holders                           | Außen-Drehhalter                | 16                |
| TDHNR/L ..     | External Tool Holders                           | Außen-Drehhalter                | 17                |
| TDJNR/L ..     | External Tool Holders                           | Außen-Drehhalter                | 17                |
| TDJNR/L .. -H  | External Turning Toolholders With Coolant Tools | Außen-Drehhalter INNENKÜHLUNG   | 18                |
| TDNNN ..       | External Tool Holders                           | Außen-Drehhalter                | 18                |
| TDNNN-H        | External Turning Toolholders With Coolant Tools | Außen-Drehhalter INNENKÜHLUNG   | 19                |
| TD-NR/L ..     | Internal Tool Holders                           | Außen-Drehhalter                | 77                |
| TDQNR/L ..     | Internal Tool Holders                           | Außen-Drehhalter                | 78                |
| TDUNR/L ..     | Internal Tool Holders                           | Außen-Drehhalter                | 78                |
| TER/L ..       | External Threading Tool Holders                 | Werkzeughalter für Außengewinde | 136               |
| TER/L ..       | Sec Tools                                       | Sec Tools                       | 72                |
| TIR/L ..       | Internal Threading Tool Holders                 | Werkzeughalter für Innengewinde | 137               |
| TSDNN ..       | External Tool Holders                           | Außen-Drehhalter                | 19                |
| TSDNN .. -H    | External Tool Holders                           | Außen-Drehhalter                | 20                |
| TSKNR/L ..     | External Tool Holders                           | Außen-Drehhalter                | 20                |
| TSKNR/L ..     | Internal Tool Holders                           | Außen-Drehhalter                | 79                |

| KOD / CODE    | AÇIKLAMA / DESCRIPTION                          | BESCHREIBUNG                  | S.N. / P.N. SEITE |
|---------------|---|-------------------------------|-------------------|
| TSSNR/L ..    | External Tool Holders                           | Außen-Drehhalter              | 21                |
| TSSNR/L .. -H | External Tool Holders                           | Außen-Drehhalter              | 21                |
| TTENN ..      | External Tool Holders                           | Außen-Drehhalter              | 22                |
| TTGNR/L ..    | External Tool Holders                           | Außen-Drehhalter              | 22                |
| TTJNR/L ..    | External Tool Holders                           | Außen-Drehhalter              | 23                |
| TTJNR/L .. -H | External Tool Holders                           | Außen-Drehhalter              | 23                |
| TT-NR/L ..    | Internal Tool Holders                           | Außen-Drehhalter              | 79                |
| TTUNR/L ..    | Internal Tool Holders                           | Außen-Drehhalter              | 80                |
| TVHNR/L ..    | External Tool Holders                           | Außen-Drehhalter              | 24                |
| TVJNR/L ..    | External Tool Holders                           | Außen-Drehhalter              | 24                |
| TVJNR/L ..-H  | External Tool Holders                           | Außen-Drehhalter              | 25                |
| TVUNR/L ..    | Internal Tool Holders                           | Außen-Drehhalter              | 80                |
| TVVNN ..      | External Tool Holders                           | Außen-Drehhalter              | 25                |
| TVVNN .. -H   | External Tool Holders                           | Außen-Drehhalter              | 26                |
| TWLNR/L ..    | External Tool Holders                           | Außen-Drehhalter              | 26                |
| TWLNR/L ..    | Internal Tool Holders                           | Außen-Drehhalter              | 81                |
| TWLNR/L .. -H | External Turning Toolholders With Coolant Tools | Außen-Drehhalter INNENKÜHLUNG | 27                |

|         |             |             |                 |
|---------|-------------|-------------|-----------------|
| AACN-.. | Spare Parts | Ersatzteile | 380             |
| AADN-.. | Spare Parts | Ersatzteile | 380             |
| AAL-..  | Spare Parts | Ersatzteile | 380             |
| AARC-.. | Spare Parts | Ersatzteile | 380             |
| AASD-.. | Spare Parts | Ersatzteile | 380             |
| AASE-.. | Spare Parts | Ersatzteile | 380             |
| AASN-.. | Spare Parts | Ersatzteile | 380             |
| AATN-.. | Spare Parts | Ersatzteile | 380             |
| AAV-..  | Spare Parts | Ersatzteile | 380             |
| AAVN-.. | Spare Parts | Ersatzteile | 380             |
| AAWN-.. | Spare Parts | Ersatzteile | 380             |
| AAV-..  | Spare Parts | Ersatzteile | 386             |
| ABK-..  | Spare Parts | Ersatzteile | 393             |
| ABKS-.. | Spare Parts | Ersatzteile | 392             |
| ABPL-.. | Spare Parts | Ersatzteile | 392             |
| ACK-..  | Spare Parts | Ersatzteile | 381             |
| ACS-..  | Spare Parts | Ersatzteile | 391             |
| AEV-..  | Spare Parts | Ersatzteile | 387             |
| AKS-..  | Spare Parts | Ersatzteile | 380             |
| AKV-..  | Spare Parts | Ersatzteile | 382-383-384-385 |
| AKY-..  | Spare Parts | Ersatzteile | 384             |
| ALA-..  | Spare Parts | Ersatzteile | 393             |
| ALV-..  | Spare Parts | Ersatzteile | 385             |
| AMK-..  | Spare Parts | Ersatzteile | 381             |
| AN-01.. | Spare Parts | Ersatzteile | 382             |
| AOR-01  | Spare Parts | Ersatzteile | 392             |
| APL-..  | Spare Parts | Ersatzteile | 385             |
| APM-..  | Spare Parts | Ersatzteile | 386             |
| AS-01   | Spare Parts | Ersatzteile | 391             |
| ATK-..  | Spare Parts | Ersatzteile | 381             |
| ATKH-.. | Spare Parts | Ersatzteile | 381             |
| ATS-..  | Spare Parts | Ersatzteile | 380             |
| AXR-01  | Spare Parts | Ersatzteile | 392             |
| 1008-.. | Spare Parts | Ersatzteile | 388             |
| 1015-.. | Spare Parts | Ersatzteile | 388             |
| 1020-.. | Spare Parts | Ersatzteile | 389             |
| 1108-.. | Spare Parts | Ersatzteile | 388             |

| KOD / CODE | AÇIKLAMA / DESCRIPTION | BESCHREIBUNG | S.N. / P.N. SEITE |
|------------|------------------------|--------------|-------------------|
| 1120-..    | Spare Parts            | Ersatzteile  | 389               |
| 1204-..    | Spare Parts            | Ersatzteile  | 387               |
| 1208-..    | Spare Parts            | Ersatzteile  | 387               |
| 1210-..    | Spare Parts            | Ersatzteile  | 387               |
| 1215-..    | Spare Parts            | Ersatzteile  | 387               |
| 1220-..    | Spare Parts            | Ersatzteile  | 387               |
| 1315-..    | Spare Parts            | Ersatzteile  | 388               |
| 1415-..    | Spare Parts            | Ersatzteile  | 389               |
| 1420-..    | Spare Parts            | Ersatzteile  | 389               |
| 1510-..    | Spare Parts            | Ersatzteile  | 388               |
| 1515-..    | Spare Parts            | Ersatzteile  | 389               |
| 1520-..    | Spare Parts            | Ersatzteile  | 389               |
| 1615-..    | Spare Parts            | Ersatzteile  | 389               |
| 1620-..    | Spare Parts            | Ersatzteile  | 389               |
| 1707-..    | Spare Parts            | Ersatzteile  | 389               |
| 1710-..    | Spare Parts            | Ersatzteile  | 389               |
| 1720-..    | Spare Parts            | Ersatzteile  | 389               |
| 1904-..    | Spare Parts            | Ersatzteile  | 385               |
| 2004-..    | Spare Parts            | Ersatzteile  | 385               |
| 2306-..    | Spare Parts            | Ersatzteile  | 391               |
| 2405-..    | Spare Parts            | Ersatzteile  | 391               |
| 2406-..    | Spare Parts            | Ersatzteile  | 391               |
| 2407-..    | Spare Parts            | Ersatzteile  | 391               |
| 2408-..    | Spare Parts            | Ersatzteile  | 391               |
| 2503-..    | Spare Parts            | Ersatzteile  | 391               |
| 2504-..    | Spare Parts            | Ersatzteile  | 391               |
| 2505-..    | Spare Parts            | Ersatzteile  | 391               |
| 2506-..    | Spare Parts            | Ersatzteile  | 391               |
| 2508-..    | Spare Parts            | Ersatzteile  | 391               |
| 2510-..    | Spare Parts            | Ersatzteile  | 391               |
| 2514-..    | Spare Parts            | Ersatzteile  | 391               |
| 2525-..    | Spare Parts            | Ersatzteile  | 391               |
| 2600-..    | Spare Parts            | Ersatzteile  | 390               |
| 2702-..    | Spare Parts            | Ersatzteile  | 390               |
| 2703-..    | Spare Parts            | Ersatzteile  | 390               |
| 2704-..    | Spare Parts            | Ersatzteile  | 390               |
| 2705-..    | Spare Parts            | Ersatzteile  | 390               |
| 2715-..    | Spare Parts            | Ersatzteile  | 390               |
| 2725-..    | Spare Parts            | Ersatzteile  | 390               |
| 3006-..    | Spare Parts            | Ersatzteile  | 388               |
| 3007-..    | Spare Parts            | Ersatzteile  | 388               |
| 3008-..    | Spare Parts            | Ersatzteile  | 388               |
| 3010-..    | Spare Parts            | Ersatzteile  | 388               |
| 3015-..    | Spare Parts            | Ersatzteile  | 388               |
| 3108-..    | Spare Parts            | Ersatzteile  | 388               |
| 4006-..    | Spare Parts            | Ersatzteile  | 388               |
| 4008-..    | Spare Parts            | Ersatzteile  | 388               |
| 4010-..    | Spare Parts            | Ersatzteile  | 388               |
| 4015-..    | Spare Parts            | Ersatzteile  | 388               |
| 4020-..    | Spare Parts            | Ersatzteile  | 389               |
| 4108-..    | Spare Parts            | Ersatzteile  | 388               |
| 4115-..    | Spare Parts            | Ersatzteile  | 389               |
| 4420-..    | Spare Parts            | Ersatzteile  | 389               |
| 4515-..    | Spare Parts            | Ersatzteile  | 389               |
| 4615-..    | Spare Parts            | Ersatzteile  | 389               |
| 80-..      | Spare Parts            | Ersatzteile  | 393               |
| 81-..      | Spare Parts            | Ersatzteile  | 396               |

 **AKKO**<sup>®</sup>





*konusulan*  
the spoken *kalite...*  
quality...



**konusulan**  
the spoken **kalite...**  
quality...





