

Technical Information **KORLOY**

Auto Tools

Turning solution for
high precision machining of
micro components



Contents



ISO type



KHP Coolant



Blade type



For Multi utility



TBGF



KGT/MGT

Auto Tools

Features 04

ISO type

- Features 06
- Inserts 15
- Holders 24

KHP Coolant (ISO Turning holder)

- Features 28
- Holders 31

Blade type

- Features 32
- Inserts 37
- Holders 38

For Multi utility

- Features 39
- Inserts 41
- Holders 43

TBGF

- Features 44
- Inserts 46
- Holders 47

KGT/MGT

- Features 48
- KGT Inserts/Holders 52
- MGT Inserts/Holders 54

MSB Tools

- Features 55
- MSB tools 58
- Sleeve 63

Fine Tools (NFTG)

- Features 64
- Inserts 66
- Holders 68

ESD Plus

- Features 69
- Holders 72



MSB Tools



Fine Tools



ESD Plus



Auto Tools

○ Auto Tools



- An automatic lathe, or a Swiss-type lathe refers to a multi-operational machine where different tools such as turning inserts, milling inserts, and drills can be mounted for automated high precision machining of micro components. It can be fed workpieces automatically by a bar feed system. It is possible to produce automatically large volumes of micro components under $\text{Ø}30$ such as electrical/electronics instruments and medical instruments. Automatic lathes can produce parts 24 hours a day. Generally, a maximum of 6 pieces of turning tools, a back plate, single sided drills, milling tools and drills can be mounted on the inner turrets.
- Many industrial products are getting smaller, lighter and more precise, while the demand grows for composite hard-to-cut materials, such as titanium alloy, nickel alloy, Inconel, etc. These parts require exacting requirements for sharp cutting edges with high class tolerances while reducing production cost and time.
- Auto Tools KF/KM are ISO type positive grooving inserts with class an E tolerance. These were designed for high feed or high depth of cut machining of both external and internal diameters. Sharp cutting edges produced by the highest quality grinding technology reduces cutting forces and provides an excellent surface finish.
- Auto Tools VP1 is a ground type insert for high precision machining. Its sharp cutting edges reduce cutting force and improve surface finish. The optimized chip breaker design provides smooth chip evacuation in hard to control applications with low depths of cut and low feeds.
- Auto Tools Blade type and multifunctional type are for high precision external machining of small parts. 4 types of inserts are available each for parting off, grooving, back turning, and threading. All can be clamped on a single holder for easy and fast tool changes, while also reducing inventory requirements.
- Auto Tools KGT/MGT are for parting off. Both provide a strong clamping system to improve stable and precise machining. They provide a wide selection of chip breakers in different cutting conditions ranging from low feed to high feed, and from continuous to interrupted machining.
- Auto Tools MSB is for internal machining of small diameters. Its high hardness grade provides excellent surface finish and long tool life. A wide application range is possible such as internal boring, grooving, threading, chamfering, etc.

○ Features

- High precision machining of small parts and complex forms, etc.
- High quality products through stable machining
- Exclusive insert for automatic lathes

○ Type

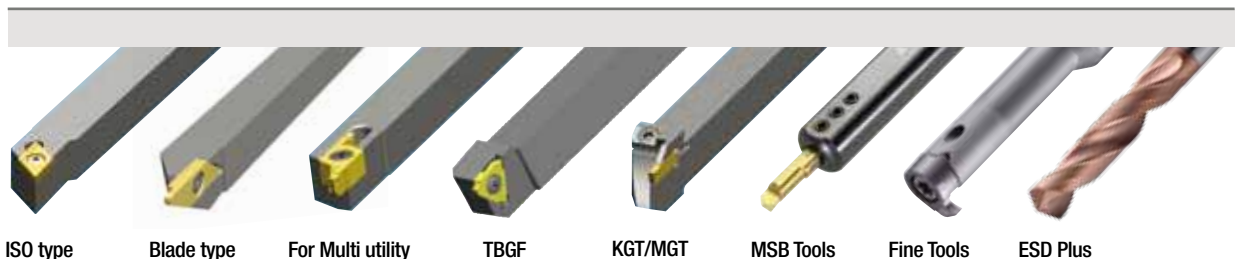

Application example

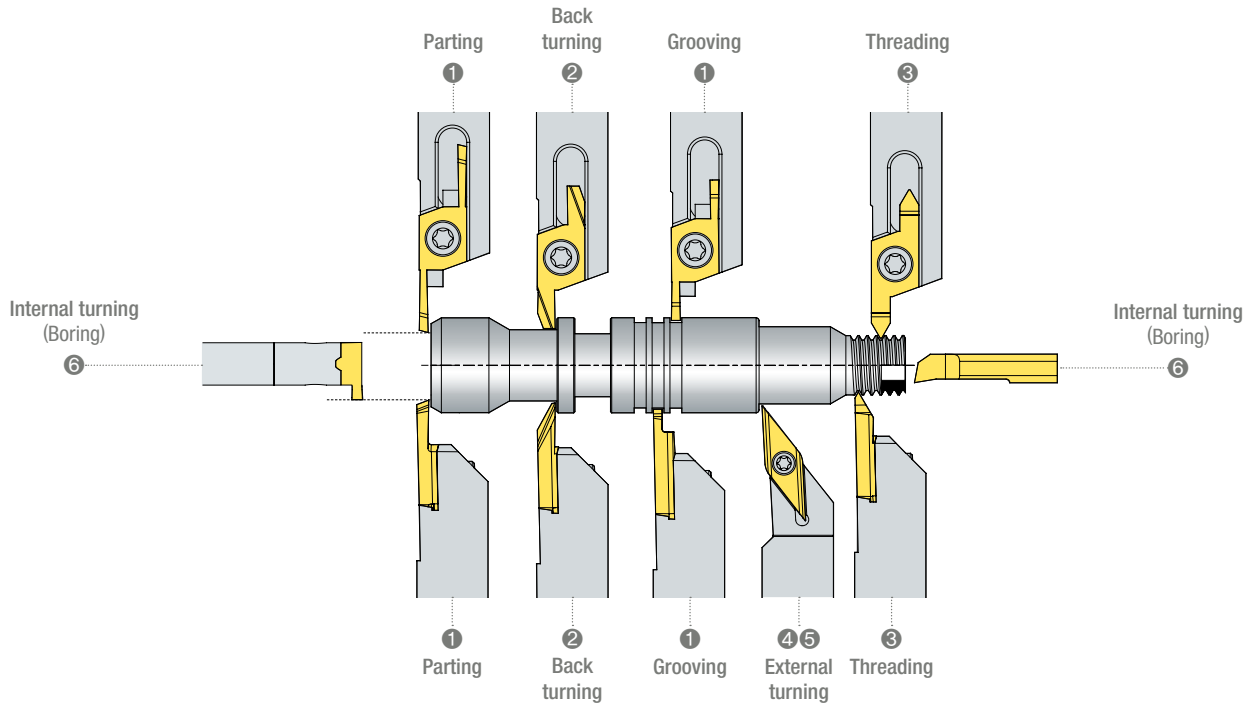

Index

Specification	① Parting and Grooving						
Holder	SXGNR/L	SXGNR/L	SBHR/L	SBHR/L	TBGFHR/L	KGEHR/L	MGEHR/L
Insert	SG	SC	SBG	SBC	TBGF	KGMN	MGMN
Holder size	10~20 mm	10~20 mm	10~16 mm	10~16 mm	10~16 mm	10~16 mm	10~16 mm
Insert shape							
Cutting width	1~3 mm	1~3 mm	0.7~2.0 mm	0.5~2.5 mm	0.33~2.50 mm	2.0~3.0 mm	1.5~2.5 mm
ØDmax	-	-	-	-	-	Ø32	Ø32

Specification	② Back turning		
Holder	SXGNR/L	SXGNR/L	SBHR/L
Insert	SB	SBG	SBB
Holder size	10~20 mm	10~20 mm	10~16 mm
Insert shape			
Cutting width	2~4 mm	2~3 mm	3.18 mm
ØDmax	Tmax 8.5	Tmax 6.5	Tmax 8.0

Specification	③ Threading	
Holder	SXGNR/L	SBHR/L
Insert	ST	SBT
Holder size	10~20 mm	10~16 mm
Insert shape		
Screw ranges	Pitch ranges 0.5~1.5/ 1.5~3.0	Pitch ranges 0.2~1.5/ 1.0~2.0

Specification	④ External turning and Copy machining				⑤ External turning and Facing		
Holder	SDJCR/L	SDNCN	SVJBR/L	SVJCR/L	SCACR/L	SCLCR/L	STACR/L
Insert	DC□□	DC□□	VB□□	VC□□	CC□□	CC□□	TC□□
Holder size	8~16 mm	8~16 mm	10~16 mm	10~16 mm	8~16 mm	8~16 mm	8~10 mm
Insert shape							
Feature	Offset "0"				Offset "0"		

Specification	⑥ Internal turning (Boring)					
Holder	SCLCR/L	STUBR/L	STUPR/L	SWUBR/L	SL□□□□	NFTIH□□□□C
Insert	CC□□	TB□□	TP□□	WB□□	M□□/L	NFT□
Holder size	Ø10	Ø8	Ø8	Ø5~8	Ø3~10	Ø6~16
Insert shape						
ØDmax	Ø5	Ø8	Ø10	Ø5.5	Ø3.2	Ø8.0

ISO type



Features

- ISO Inserts for automatic lathes
- Precise R shape with the use of minus tolerance of nose R
- Tolerance class precise enough in no need for adjusting tools with the use of accurate cutting edge height
- Sharp blade for excellent chip control and surface roughness with low cutting force
- High precision tools for electrical/ electronics instruments and medical instruments



Code system (ISO type)

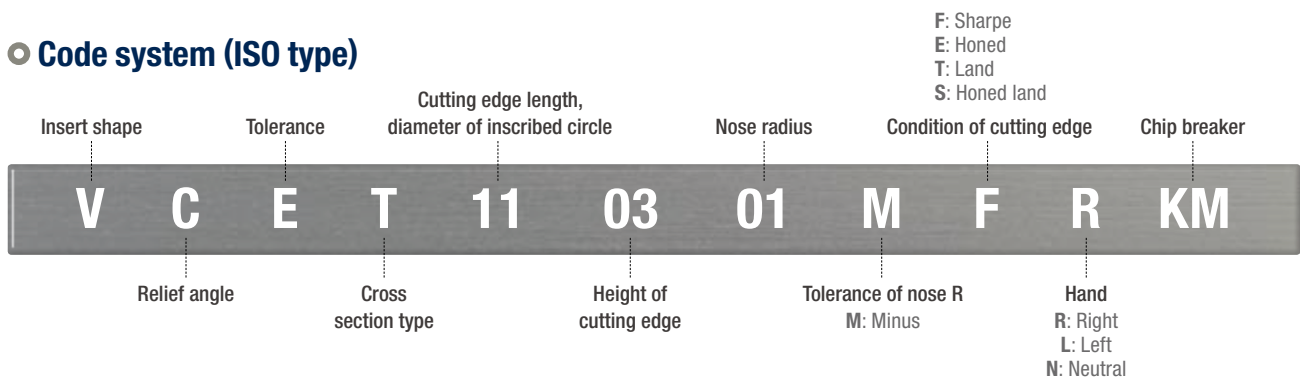



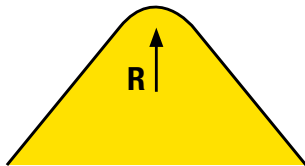

Only for premium classes

Nose R (Tolerance of Corner R)



Symbol	Tolerance	No
M	+0 -0.02	Tolerance of corner R

Cutting edge condition

Symbol	Shape	Edge prep state
F		Sharp selection
E		Honing selection
T		Land
S		Land & Honing

Hand of insert

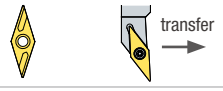
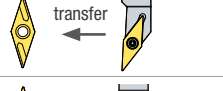
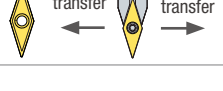
Symbol	Shape
R	
L	
N	

KF (E&G Class tolerance)



- For finishing
- Low cutting loads with sharp cutting edges
- Longer tool life due to lower chip evacuation resistance at high speed
- Excellent surface roughness

KM (E&G Class tolerance)



- For medium cutting to finishing
- Better chip flow due to wide chip pockets
- Longer tool life and better cutting action due to improved chip evacuation
- Excellent surface roughness

VP1 (G Class tolerance)



- Hard cutting edge for medium cutting
- Optimal width of chip breaker by each depth of cuts realizes wide workpiece machining.

MS (G Class tolerance)



- Good surface finish for medium cutting
- Preventing welding in Titanium machining
- Increasing chip evacuation in high feed machining
- Protecting cutting edge due to structure for good chip evacuation

FS (G Class tolerance)



- For finishing (for surface roughness)
- 1st recommended chip breaker for chip control
- Better surface roughness, surface finish and chip control



Insert tolerance

- Managing the tolerance of cutting edge, size of 'm' part, and the nose R under 0.02 mm at ultra precision level.
- The tolerance of nose R is managed by minus level to prevent expansion of the workpiece's nose R size from 0.02 mm

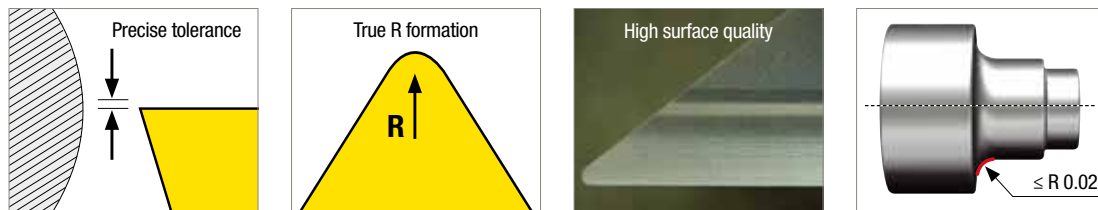

Symbol	d	t	m	r
	Inscribed circle	Thickness	Refer to figure	Nose radius
G	±0.025	±0.04	±0.025	-
G + MFN (Ultra-precision)	±0.02	±0.02	±0.02	0~-0.02
E + MFN (Ultra-precision)	±0.013	±0.02	±0.013	0~-0.02

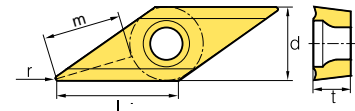

※ Tight tolerance and deviation management is applied to ultra-precision inserts, and it is recommended to use the tool in the condition of high precision and low deviation machining is necessity.

Sharp cutting edge

- To minimize cutting load and heat, extremely sharp and stable cutting edges have been realized by high technology (without full abrasive honing)

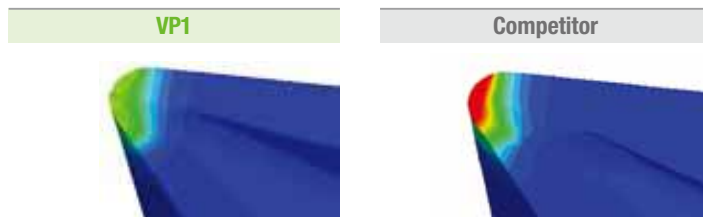

Precise cutting process and superior surface roughness

- Compared to other competitors our insert provides a sharper cutting edge, which helps ensuring the uniformed surface roughness.

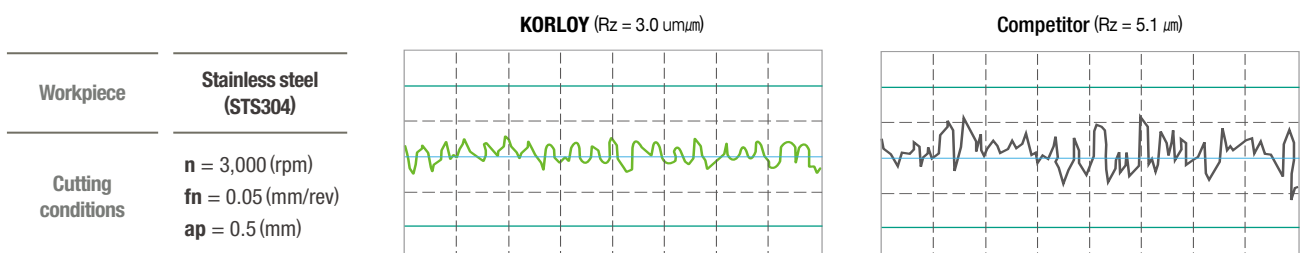

○ Cutting performance of KF/KM

Wear resistance- External machining

• **Workpiece:** Stainless steel (X5CrNi18-9)

Cutting conditions • **vc** = 200 m/min • **fn** = 0.05 mm/rev • **ap** = 0.5 mm • **etc** = Dia. Ø20 mm, Machining 20 pass

VPET080202MFR-KF (PC8110)

Competitor

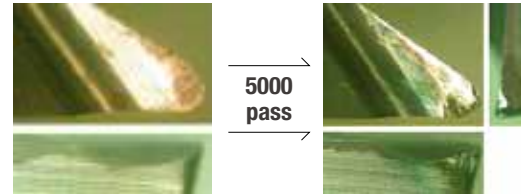

Roughness- External machining

• **Workpiece:** Stainless steel (X5CrNi18-9)

Cutting conditions • **vc** = 200 m/min • **fn** = 0.05 mm/rev • **ap** = 0.5 mm, Wet

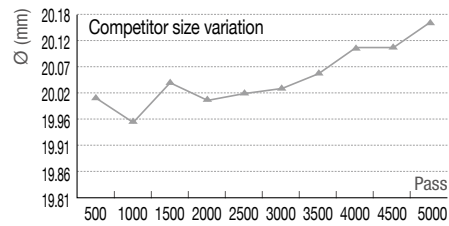
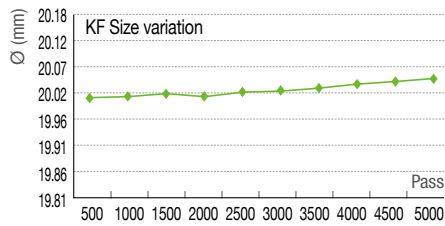

Wear resistance- External machining

• **Workpiece:** Stainless steel (X5CrNiMo17-12-2)

Cutting conditions • **vc** = 200 m/min • **fn** = 0.05 mm/rev • **ap** = 0.5 mm • **etc** = Dia. Ø20 mm, Machining 20 pass

DCET11T302MFR-KM (PC8110)

Competitor

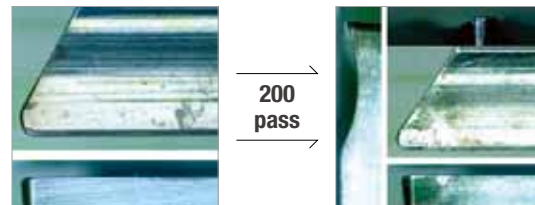
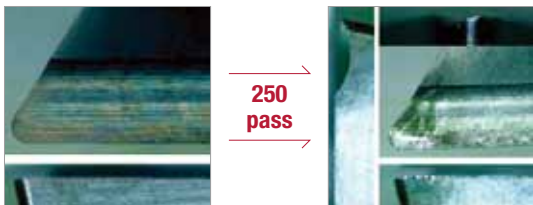

Roughness- External machining

• **Workpiece:** Stainless steel (X5CrNiMo17-12-2)

Cutting conditions • **vc** = 200 m/min • **fn** = 0.05 mm/rev • **ap** = 0.5 mm, Wet

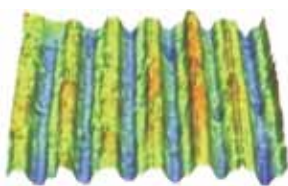

Rz: 2.71 µm

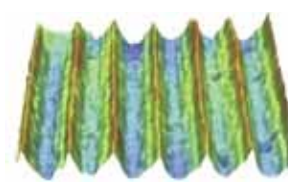

Rz: 4.62 µm



VP1 Cutting performance

Wear resistance- External machining

• **Workpiece:** Stainless steel (X5CrNiMo17-12-2)

• **Cutting conditions** • $vc = 100$ m/min • $fn = 0.07$ mm/rev • $ap = 0.5$ mm, Wet • **etc** = Dia. $\varnothing 20$ mm, Machining 20 pass

DCGT11T302MFN-VP1 (PC8110)

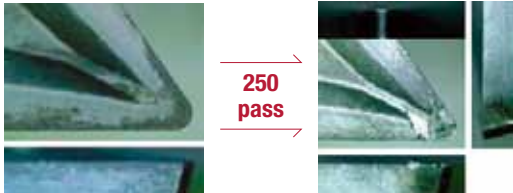

250
pass

Competitor



200
pass

Roughness- External machining

• **Workpiece:** Stainless steel (X5CrNiMo17-12-2)

• **Cutting conditions** • $vc = 100$ m/min • $fn = 0.07$ mm/rev • $ap = 0.5$ mm, Wet

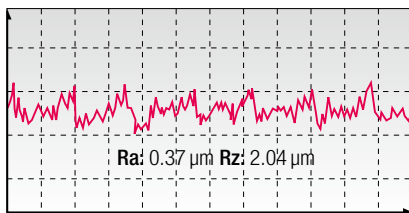

DCGT11T302MFN-VP1

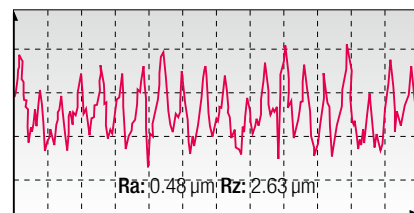

DCGT11T302

Chip breaking- External machining

• **Workpiece:** Stainless steel (X5CrNiMo17-12-2)

• **Cutting conditions** • $vc = 100$ m/min • $fn = 0.03 \sim 0.1$ mm/rev • $ap = 0.3 \sim 2.0$ mm, Wet

DCGT11T302MFN-VP1 (PC8110)

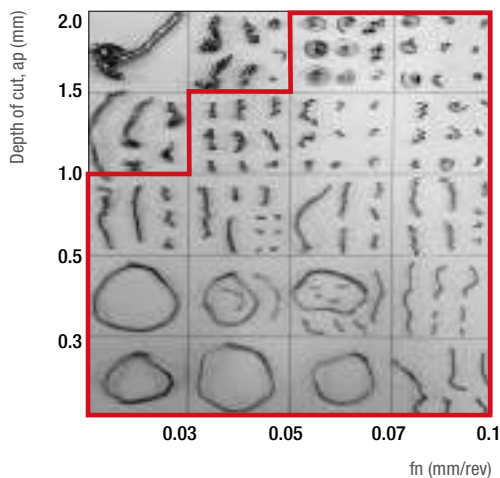

Competitor

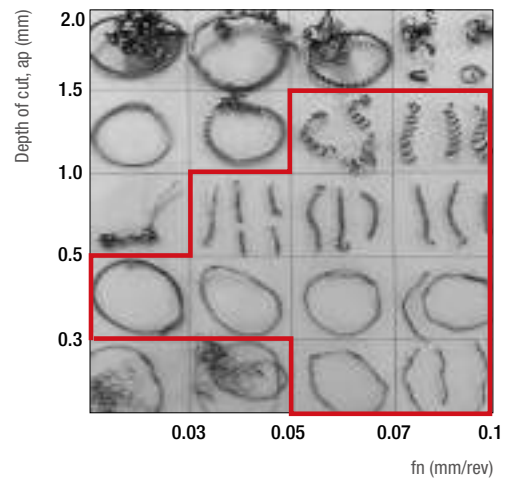

FS Cutting performance

Chip control

• **Workpiece:** Alloy steel (S42CrMo4), Stainless steel (X5CrNi18-9) • **Insert:** DCGT11T302-FS (PC5300) • **Holder:** SDJCR1212-X11A

Cutting conditions • **vc** = 100 m/min • **fn** = 0.03~0.13 mm/rev • **ap** = 0.5~1.0 mm, wet

Alloy steel (S42CrMo4)

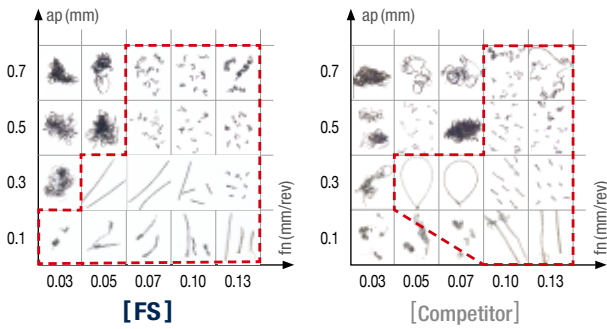

Stainless steel (X5CrNi18-9)

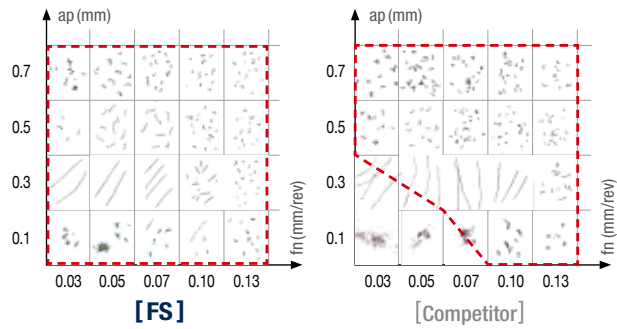

- 2 step rear angle shape ensures excellent chip control in alloy steel and stainless steel machining with from low to high depth of cut.

Workpiece size and surface finish

• **Workpiece:** Stainless steel (X12CrS13) • **Insert:** VCGT110301-FS (PC8110) • **Holder:** SVJCR1212-X11A

Cutting conditions • **vc** = 80 m/min • **n** = 1,000 rpm • **fn** = 0.05 mm/rev • **ap** = 0.1 mm, wet

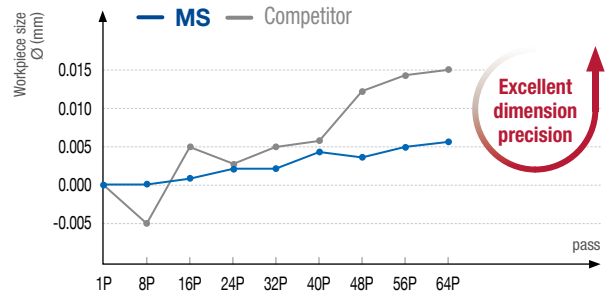
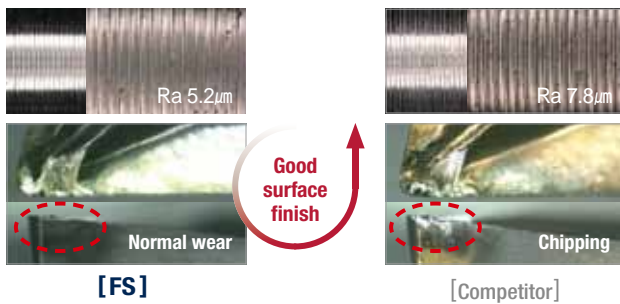

- 3-dimensional and sharp cutting edge reduces cutting load and cutting heat ensuring stable machining and surface finish.

Wear resistance

• **Workpiece:** Alloy steel (S42CrMo4) • **Insert:** CCGT09T304-FS (PC8110) • **Holder:** SCLCR1212-X09A

Cutting conditions • **vc** = 100 m/min • **n** = 1,000 rpm • **fn** = 0.05 mm/rev • **ap** = 0.5 mm, wet

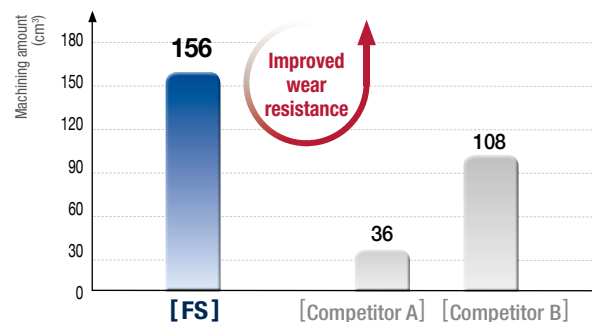
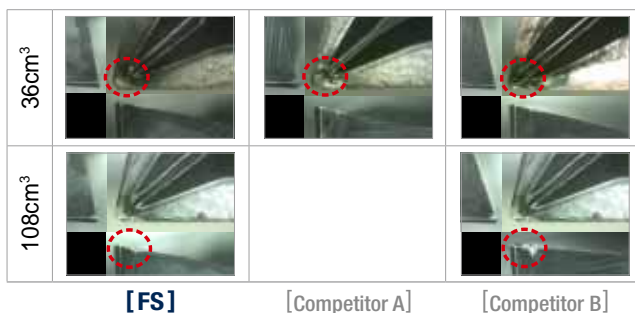

- FS chip breaker applied mirror-like finished cutting edge, ultra-fine substrate and high hardness coating ensure longer tool life than competitor's one.



MS Cutting performance

Wear resistance

• **Workpiece:** Pure titanium (5832-2) • **Insert:** VCGT1203008FN-MS (PC8110) • **Holder:** SVJCR1212-X12A

Cutting conditions • **vc** = 100 m/min • **n** = 3,500 rpm • **fn** = 0.03 mm/rev • **ap** = 0.5 mm, wet

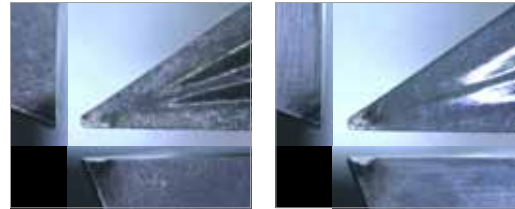
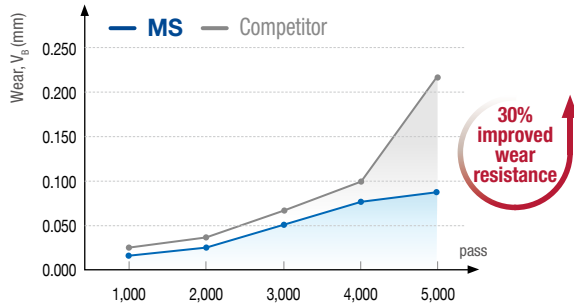

[MS]

[Competitor]

- Ultra-fine substrate and high hardness coating ensure stable tool life.

Chip control and surface finish

• **Workpiece:** Stainless steel (X5CrNi18-9) • **Insert:** VCGT120302FN-MS (PC5300) • **Holder:** SVJCR1212-X12A

Cutting conditions • **vc** = 120 m/min • **n** = 4,000 rpm • **fn** = 0.03 mm/rev • **ap** = 0.1, 0.3, 0.5 (mm), wet

MS

Competitor

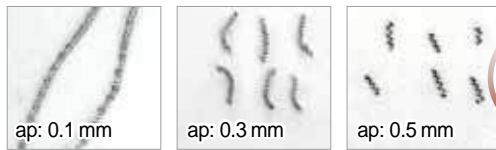

Good chip control



- Three-dimensional shaped design of chip breaker increases chip evacuation.

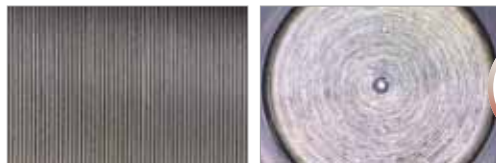

Good surface finish

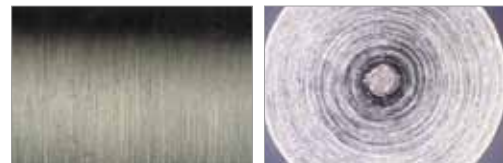

- Sharp and mirror-like finished cutting edge improves surface finish.

Dimension precision

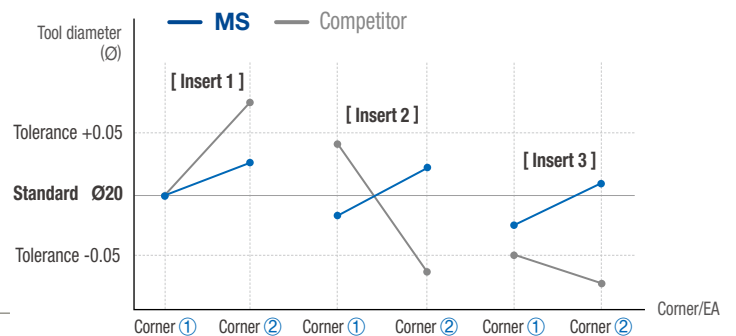
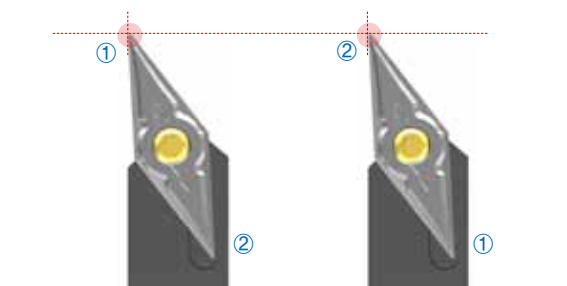

- Changing tool offset in switching insert corners and items is not necessary using MS chip breaker due to tight dimension deviation management.

○ The comparison of chip breaker

Category	Application	KORLOY	Competitor A	Competitor B	Competitor C	Competitor D	Competitor E	Competitor F	Competitor G
Chip breaker	Medium cutting (for toughness)	VP1	GF	SM	FS	-None	FC	AM3	FN-None
	Medium cutting (for surface finish)	MS	GQ	SH	LS	01	SC	AM3	FN-None
	Medium to finishing	KM	USF, U, J	GF	SN	JPP	FY, FX, FZ	U, U1	FR-None FL-None
	Finishing	KF	FSF, F, A3	FF	SR	JRP	A2	FG	FR-None FL-None
	Finishing	FS	SK, CF	SA, SL	SMG, FJ	JS	SI	YL	-
Grade	General cutting	PC5300	PR1125	TT9020	VP15TF	SH725	AC1030U	DM4	D60
	S10	PC8110	PR1310	TT5080	VP10RT	SH730	AC510U	ZM3	D20

○ Application range

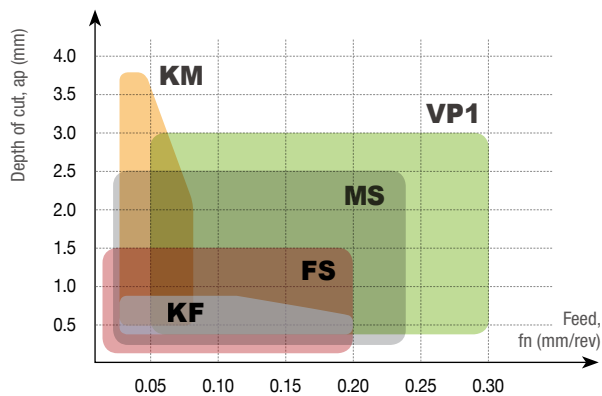

Cutting range	Chip breaker	ap (mm)	fn (mm/rev)
Medium cutting (for toughness)	VP1	0.3~3.5	0.05~0.30
Medium cutting (for surface roughness)	MS	0.2~2.5	0.03~0.25
Medium to finishing	KM	0.05~3.50	0.03~0.07
Finishing	KF	0.03~0.09	0.03~0.20
Finishing	FS	0.1~1.5	0.01~0.20

○ Grades and recommended cutting conditions

Workpiece	Grade	Recommended cutting speed, vc (m/min)				
		50	100	200	300	500
P Steel	PC8110	50		180		
	PC5300	40		150		
M Stainless steel	PC8105	50		180		
	PC8110	50		170		
	PC8115	40		150		
	PC5300	40		140		
N Non-ferrous metal	H01			130		460
	PC8110			150		500
S HRSA	H01	20	40			
	PC8105	25	60			
	PC8110	20	60			
	PC8115	20	50			
	PC5300	20	40			



Application examples (FS Chip breaker)

Stainless steel (X5CrNi18-9)

• **Workpiece use:** Component of automobile fuel gauge • **Insert:** CCGT09T302-FS (PC5300) • **Holder:** SCLCL1212-X09A

Cutting conditions • $vc = 80$ m/min • $n = 2,500$ rpm • $fn = 0.11$ mm/rev • $ap = 0.5$ mm, wet

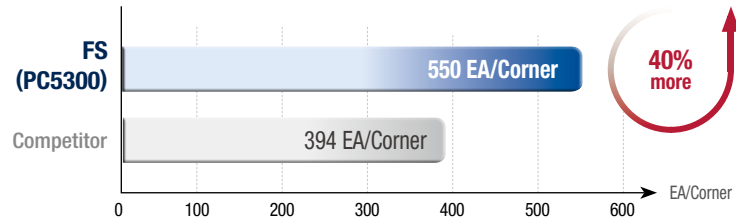

- Prevented welding due to sharp cutting edge and mirror-like finished coating
- Minimized cutting heat in stainless steel machining

Carbon steel (C10)

• **Workpiece use:** Component of automobile engine • **Insert:** DCGT11T302-FS (PC8110) • **Holder:** SDJCL1212-X11A

Cutting conditions • $vc = 100$ m/min • $n = 3,000$ rpm • $fn = 0.1$ mm/rev • $ap = 0.5$ mm, wet

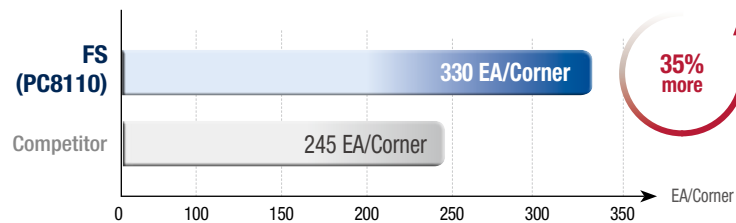

- Excellent chip evacuation due to better chip control

Carbon steel (C45)

• **Workpiece use:** Turbo charger roller pin • **Insert:** VCGT110301-FS (PC5300) • **Holder:** SVJCR1212-X11A

Cutting conditions • $vc = 260$ m/min • $n = 2,000$ rpm • $fn = 0.1$ mm/rev • $ap = 0.5\sim 1.0$ mm, wet

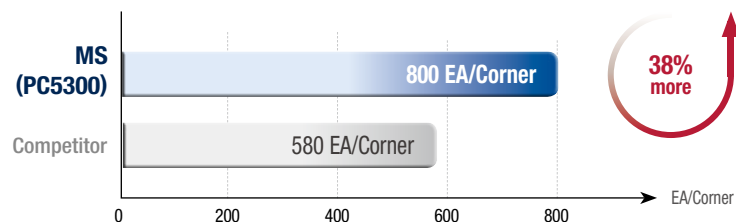

- Prevented welding due to sharp cutting edge and mirror-like finished coating
- Prevented microchipping by ultra-fine substrate and long tool life from high hardness oxidation coating

Application examples (MS Chip breaker)

Pure titanium (5832-2)

• **Workpiece use:** Component of automobile fuel gauge • **Insert:** CCGT09T302-FS (PC5300) • **Holder:** SCLCL1212-X09A

Cutting conditions • **vc** = 80 m/min • **n** = 2,500 rpm • **fn** = 0.11 mm/rev • **ap** = 0.5 mm, wet

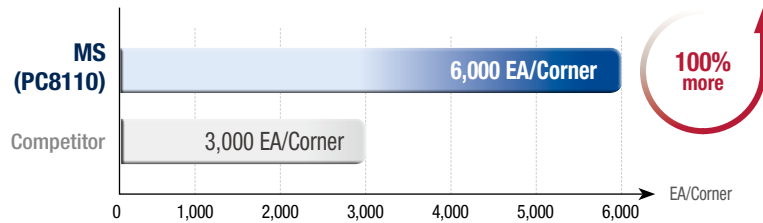

- Sharp cutting edge and mirror-like coating prevent cutting heat and welding.
- Ultra-fine substrate prevents micro chipping and coating layer with high hardness at high temperature and good oxidation resistance increases tool life.

Titanium alloy (5832-3)

• **Workpiece use:** Fixture (Implant) • **Insert:** VCGT120301FN-MS (PC5300) • **Holder:** SVJCR1212-X12A

Cutting conditions • **vc** = 120 m/min • **n** = 5,000 rpm • **fn** = 0.03 mm/rev • **ap** = 0.5 mm, wet

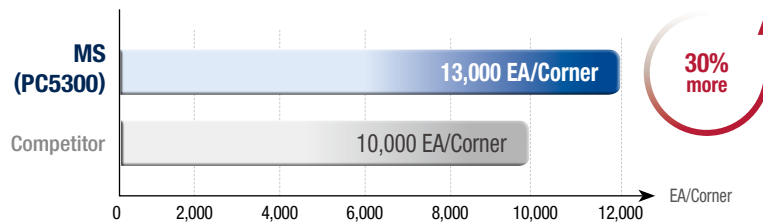

- Sharp cutting edge and mirror-like coating prevent cutting heat and welding.
- Ultra-fine substrate prevents micro chipping and coating layer with high hardness at high temperature and good oxidation resistance increases tool life.

Titanium alloy (5832-3)

• **Workpiece use:** Abutment (Implant) • **Insert:** VCGT1203008FN-MS (PC8110) • **Holder:** SVJCR1212-X12A

Cutting conditions • **vc** = 120 m/min • **n** = 5,000 rpm • **fn** = 0.05 mm/rev • **ap** = 0.1 mm, wet

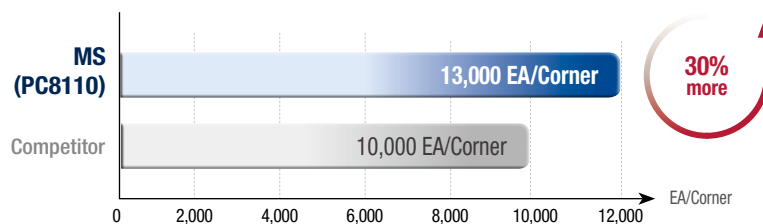

- Sharp cutting edge and mirror-like coating prevent cutting heat and welding.
- Ultra-fine substrate prevents micro chipping and coating layer with high hardness at high temperature and good oxidation resistance increases tool life.







● **Applicable inserts**

Insert

Type	C/B		Designation	Coated					Uncoated					Configuration				
	Picture	Designation		PC5300	PC8105	PC8110	PC8115	H01	l	Ød	t	r	Ød ₁					
Finishing (High precision)				CCGT	0301003R-KF	●	●				3.6	3.5	1.39	0.03	1.9			
	030101R-KF	●			●				3.5	3.5	1.39	0.10	1.9					
	030102R-KF	●			●				3.5	3.5	1.39	0.20	1.9					
	030104R-KF	●			●				3.5	3.5	1.39	0.40	1.9					
	0401003R-KF	●			●				4.4	4.3	1.79	0.03	2.3					
	040101R-KF	●			●				4.4	4.3	1.79	0.10	2.3					
	040102R-KF	●			●				4.3	4.3	1.79	0.20	2.3					
	040104R-KF	●			●				4.3	4.3	1.79	0.40	2.3					
	0602003R-KF								6.6	6.35	2.38	0.03	2.8					
	060201R-KF								6.4	6.35	2.38	0.10	2.8					
	060202R-KF								6.2	6.35	2.38	0.20	2.8					
	09T3003R-KF								9.8	9.525	3.97	0.03	4.4					
	09T301R-KF								9.6	9.525	3.97	0.10	4.4					
	09T302R-KF								9.2	9.525	3.97	0.20	4.4					
	0301003L-KF	●			●				3.6	3.5	1.39	0.03	1.9					
	030101L-KF	●			●				3.5	3.5	1.39	0.10	1.9					
	030102L-KF	●			●				3.5	3.5	1.39	0.20	1.9					
	030104L-KF	●			●				3.5	3.5	1.39	0.40	1.9					
	0401003L-KF	●			●				4.4	4.3	1.79	0.03	2.3					
	040101L-KF	●			●				4.4	4.3	1.79	0.10	2.3					
	040102L-KF	●			●				4.3	4.3	1.79	0.20	2.3					
	040104L-KF	●			●				4.3	4.3	1.79	0.40	2.3					
	0602003L-KF								6.6	6.35	2.38	0.03	2.8					
	060201L-KF								6.4	6.35	2.38	0.10	2.8					
	060202L-KF								6.2	6.35	2.38	0.20	2.8					
	09T3003L-KF								9.8	9.525	3.97	0.03	4.4					
	09T301L-KF								9.6	9.525	3.97	0.10	4.4					
	09T302L-KF								9.2	9.525	3.97	0.20	4.4					
	Finishing (Ultra-precision)				CCET	0602005MFR-KF	●	●				6.6	6.35	2.38	<0.05		2.8	
						060201MFR-KF	●	●				6.4	6.35	2.38	<0.10		2.8	
060202MFR-KF			●	●					6.2	6.35	2.38	<0.20	2.8					
09T3005MFR-KF			●	●					9.8	9.525	3.97	<0.05	4.4					
09T301MFR-KF			●	●					9.6	9.525	3.97	<0.10	4.4					
09T302MFR-KF			●	●					9.2	9.525	3.97	<0.20	4.4					
0602005MFL-KF			●	●					6.6	6.35	2.38	<0.05	2.8					
060201MFL-KF			●	●					6.4	6.35	2.38	<0.10	2.8					
060202MFL-KF			●	●					6.2	6.35	2.38	<0.20	2.8					
09T3005MFL-KF			●	●					9.8	9.525	3.97	<0.05	4.4					
09T301MFL-KF			●	●					9.6	9.525	3.97	<0.10	4.4					
09T302MFL-KF			●	●					9.2	9.525	3.97	<0.20	4.4					

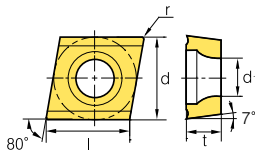
●: Stock item

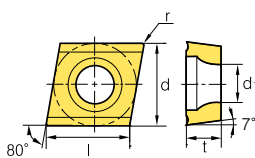
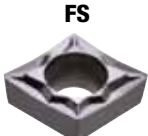
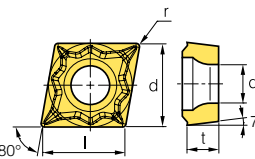

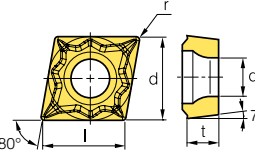



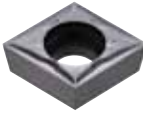
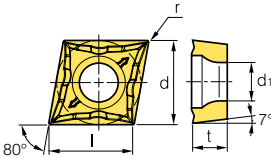

Insert

Type	C/B		Coated				Uncoated	Dimensions (mm)					Configuration		
	Picture	Designation	PC5300	PC8105	PC8110	PC8115	H01	l	Ød	t	r	Ød ₁			
Medium to finishing (High precision)		CCGT	0602003R-KM	●	●				6.6	6.35	2.38	0.03	2.8		
			060201R-KM	●	●					6.4	6.35	2.38	0.10		2.8
			060202R-KM	●	●					6.2	6.35	2.38	0.20		2.8
			060204R-KM	●	●					6.2	6.35	2.38	0.40		2.8
			09T3003R-KM	●	●					9.8	9.525	3.97	0.03		4.4
			09T301R-KM	●	●					9.6	9.525	3.97	0.10		4.4
			09T302R-KM	●	●					9.2	9.525	3.97	0.20		4.4
			09T304R-KM	●	●					9.2	9.525	3.97	0.40		4.4
			0602003L-KM	●	●					6.6	6.35	2.38	0.03		2.8
			060201L-KM	●	●					6.4	6.35	2.38	0.10		2.8
			060202L-KM	●	●					6.2	6.35	2.38	0.20		2.8
			060204L-KM	●	●					6.2	6.35	2.38	0.40		2.8
			09T3003L-KM	●	●					9.8	9.525	3.97	0.03		4.4
			09T301L-KM	●	●					9.6	9.525	3.97	0.10		4.4
			09T302L-KM	●	●					9.2	9.525	3.97	0.20		4.4
09T304L-KM	●	●					9.2	9.525	3.97	0.40	4.4				
Medium to finishing (Ultra-precision)		CCET	0602005MFR-KM	●	●				6.6	6.35	2.38	<0.05	2.8		
			060201MFR-KM	●	●					6.4	6.35	2.38	<0.10		2.8
			060202MFR-KM	●	●					6.2	6.35	2.38	<0.20		2.8
			09T3005MFR-KM	●	●					9.8	9.525	3.97	<0.05		4.4
			09T301MFR-KM	●	●					9.6	9.525	3.97	<0.10		4.4
			09T302MFR-KM	●	●					9.2	9.525	3.97	<0.20		4.4
			0602005MFL-KM	●	●					6.6	6.35	2.38	<0.05		2.8
			060201MFL-KM	●	●					6.4	6.35	2.38	<0.10		2.8
			060202MFL-KM	●	●					6.2	6.35	2.38	<0.20		2.8
			09T3005MFL-KM	●	●					9.8	9.525	3.97	<0.05		4.4
09T301MFL-KM	●	●					9.6	9.525	3.97	<0.10	4.4				
09T302MFL-KM	●	●					9.2	9.525	3.97	<0.20	4.4				
Finishing (High precision)		CCGT	060201-FS	●	●				6.3	6.35	2.38	0.10	2.8		
			060202-FS	●	●					6.2	6.35	2.38	0.20		2.8
			060204-FS	●	●					6.0	6.35	2.38	0.40		2.8
			09T301-FS	●	●					9.8	9.525	3.97	0.10		4.4
			09T302-FS	●	●					9.6	9.525	3.97	0.20		4.4
			09T304-FS	●	●					9.2	9.525	3.97	0.40		4.4
			09T308-FS	●	●					8.8	9.525	3.97	0.80		4.4
Finishing (Ultra-precision)		CCGT	060201MFN-FS						6.3	6.35	2.38	< 0.1	2.8		
			060202MFN-FS							6.2	6.35	2.38	< 0.2		2.8
			060204MFN-FS							6.0	6.35	2.38	< 0.4		2.8
			09T301MFN-FS							9.8	9.525	3.97	< 0.1		4.4
			09T302MFN-FS							9.6	9.525	3.97	< 0.2		4.4
			09T304MFN-FS							9.2	9.525	3.97	< 0.4		4.4
			09T308MFN-FS							8.8	9.525	3.97	< 0.8		4.4

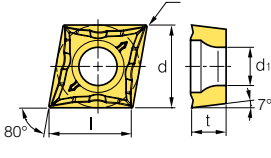
●: Stock item

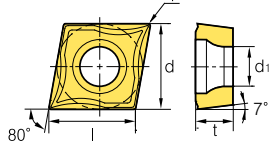

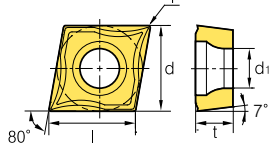

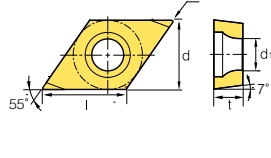

Insert

Type	C/B	Designation	Coated					Uncoated					Configuration
	Picture		PC5300	PC8105	PC8110	PC8115	H01	l	Ød	t	r	Ød ₁	
Medium cutting (High precision)	MS 	CCGT 09T301-MS	●	●				9.8	9.525	3.97	0.10	4.4	
		09T302-MS	●	●				9.6	9.525	3.97	0.20	4.4	
		09T304-MS	●	●				9.2	9.525	3.97	0.40	4.4	
Medium cutting (Ultra-precision)	MS 	CCGT 09T301MFN-MS	●	●				9.8	9.525	3.97	< 0.1	4.4	
		09T302MFN-MS	●	●				9.6	9.525	3.97	< 0.2	4.4	
		09T304MFN-MS	●	●				9.2	9.525	3.97	< 0.4	4.4	
Finishing (High precision)	VP1 	CCGT 60201-VP1	●	●	●	●	●	6.6	6.35	2.38	0.10	2.8	
		60202-VP1	●	●	●	●	●	6.4	6.35	2.38	0.20	2.8	
		60204-VP1	●	●	●	●	●	6.2	6.35	2.38	0.40	2.8	
		09T301-VP1	●	●	●	●	●	9.8	9.525	3.97	0.10	4.4	
		09T302-VP1	●	●	●	●	●	9.6	9.525	3.97	0.20	4.4	
		09T304-VP1	●	●	●	●	●	9.2	9.525	3.97	0.40	4.4	
Finishing (Ultra-precision)	VP1 	CCGT 060201MFN-VP1	●	●				6.6	6.35	2.38	<0.10	2.8	
		060202MFN-VP1	●	●				6.4	6.35	2.38	<0.20	2.8	
		060204MFN-VP1	●	●				6.2	6.35	2.38	<0.40	2.8	
		09T301MFN-VP1	●	●				9.8	9.525	3.97	<0.10	4.4	
		09T302MFN-VP1	●	●				9.6	9.525	3.97	<0.20	4.4	
		09T304MFN-VP1	●	●				9.2	9.525	3.97	<0.40	4.4	
Finishing (High precision)	KF 	DCGT 0702003R-KF	●	●				7.8	6.35	2.38	0.03	2.8	
		070201R-KF	●	●				7.8	6.35	2.38	0.10	2.8	
		070202R-KF	●	●				7.8	6.35	2.38	0.20	2.8	
		070204R-KF	●	●				7.8	6.35	2.38	0.40	2.8	
		11T3003R-KF	●	●				11.6	9.525	3.97	0.03	4.4	
		11T301R-KF	●	●				11.6	9.525	3.97	0.10	4.4	
		11T302R-KF	●	●				11.6	9.525	3.97	0.20	4.4	
		11T304R-KF	●	●				11.6	9.525	3.97	0.40	4.4	
		0702003L-KF	●	●				7.8	6.35	2.38	0.03	2.8	
		070201L-KF	●	●				7.8	6.35	2.38	0.10	2.8	
		070202L-KF	●	●				7.8	6.35	2.38	0.20	2.8	
		070204L-KF	●	●				7.8	6.35	2.38	0.40	2.8	
		11T3003L-KF	●	●				11.6	9.525	3.97	0.03	4.4	
		11T301L-KF	●	●				11.6	9.525	3.97	0.10	4.4	
		11T302L-KF	●	●				11.6	9.525	3.97	0.20	4.4	
		11T304L-KF	●	●				11.6	9.525	3.97	0.40	4.4	

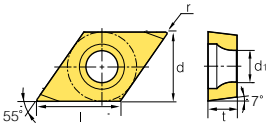
●: Stock item

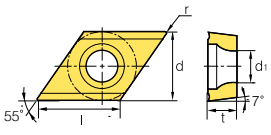
Insert

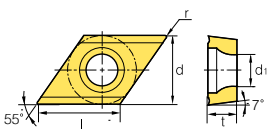
Type	C/B		Coated					Uncoated	Dimensions (mm)					Configuration
	Picture	Designation	PC5300	PC8105	PC8110	PC8115	H01	l	Ød	t	r	Ød ₁		
Finishing (Ultra-precision)		DCET	0702005MFR-KF	●	●				7.8	6.35	2.38	<0.05	2.8	
			070201MFR-KF	●	●				7.8	6.35	2.38	<0.10	2.8	
			070202MFR-KF	●	●				7.8	6.35	2.38	<0.20	2.8	
			11T3005MFR-KF	●	●				11.6	9.525	3.97	<0.05	4.4	
			11T301MFR-KF	●	●				11.6	9.525	3.97	<0.10	4.4	
			11T302MFR-KF	●	●				11.6	9.525	3.97	<0.20	4.4	
			0702005MFL-KF	●	●				7.8	6.35	2.38	<0.05	2.8	
			070201MFL-KF	●	●				7.8	6.35	2.38	<0.10	2.8	
			070202MFL-KF	●	●				7.8	6.35	2.38	<0.20	2.8	
			11T3005MFL-KF	●	●				11.6	9.525	3.97	<0.05	4.4	
			11T301MFL-KF	●	●				11.6	9.525	3.97	<0.10	4.4	
			11T302MFL-KF	●	●				11.6	9.525	3.97	<0.20	4.4	
Medium to finishing (High precision)		DCGT	0702003R-KM	●	●				7.8	6.35	2.38	0.03	2.8	
			070201R-KM	●	●				7.8	6.35	2.38	0.10	2.8	
			070202R-KM	●	●				7.8	6.35	2.38	0.20	2.8	
			070204R-KM	●	●				7.8	6.35	2.38	0.40	2.8	
			11T3003R-KM	●	●				11.6	9.525	3.97	0.03	4.4	
			11T301R-KM	●	●				11.6	9.525	3.97	0.10	4.4	
			11T302R-KM	●	●				11.6	9.525	3.97	0.20	4.4	
			11T304R-KM	●	●				11.6	9.525	3.97	0.40	4.4	
			0702003L-KM	●	●				7.8	6.35	2.38	0.03	2.8	
			070201L-KM	●	●				7.8	6.35	2.38	0.10	2.8	
			070202L-KM	●	●				7.8	6.35	2.38	0.20	2.8	
			070204L-KM	●	●				7.8	6.35	2.38	0.40	2.8	
			11T3003L-KM	●	●				11.6	9.525	3.97	0.03	4.4	
			11T301L-KM	●	●				11.6	9.525	3.97	0.10	4.4	
			11T302L-KM	●	●				11.6	9.525	3.97	0.20	4.4	
			11T304L-KM	●	●				11.6	9.525	3.97	0.40	4.4	
Medium to finishing (Ultra-precision)		DCET	0702005MFR-KM	●	●				7.8	6.35	2.38	<0.05	2.8	
			070201MFR-KM	●	●				7.8	6.35	2.38	<0.10	2.8	
			070202MFR-KM	●	●				7.8	6.35	2.38	<0.20	2.8	
			11T3005MFR-KM	●	●				11.6	9.525	3.97	<0.05	4.4	
			11T301MFR-KM	●	●				11.6	9.525	3.97	<0.10	4.4	
			11T302MFR-KM	●	●				11.6	9.525	3.97	<0.20	4.4	
			0702005MFL-KM	●	●				7.8	6.35	2.38	<0.05	2.8	
			070201MFL-KM	●	●				7.8	6.35	2.38	<0.10	2.8	
			070202MFL-KM	●	●				7.8	6.35	2.38	<0.20	2.8	
			11T3005MFL-KM	●	●				11.6	9.525	3.97	<0.05	4.4	
			11T301MFL-KM	●	●				11.6	9.525	3.97	<0.10	4.4	
			11T302MFL-KM	●	●				11.6	9.525	3.97	<0.20	4.4	

●: Stock item











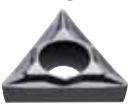
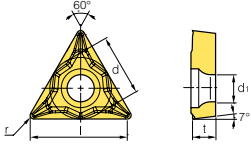
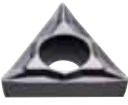
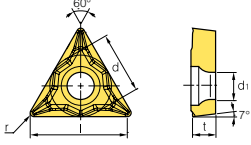

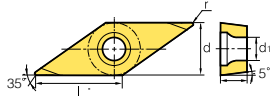
Insert

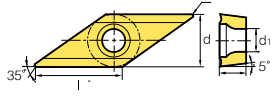
Type	C/B	Designation	Coated					Uncoated					Configuration
	Picture		PC5300	PC8105	PC8110	PC8115	H01	l	Ød	t	r	Ød ₁	
Finishing (High precision)		DCGT	070201-FS	●	●			7.6	6.35	2.38	0.10	2.8	
			070202-FS	●	●			7.5	6.35	2.38	0.20	2.8	
			11T301-FS	●	●			11.6	9.525	3.97	0.10	4.4	
			11T302-FS	●	●			11.6	9.525	3.97	0.20	4.4	
			11T304-FS	●	●			11.6	9.525	3.97	0.40	4.4	
			11T308-FS	●	●			11.6	9.525	3.97	0.80	4.4	
Finishing (Ultra-precision)		DCGT	070201MFN-FS					7.6	6.35	2.38	< 0.1	2.8	
			070202MFN-FS					7.5	6.35	2.38	< 0.2	2.8	
			11T301MFN-FS					11.6	9.525	3.97	< 0.1	4.4	
			11T302MFN-FS					11.4	9.525	3.97	< 0.2	4.4	
			11T304MFN-FS					11.2	9.525	3.97	< 0.4	4.4	
			11T308MFN-FS					11.0	9.525	3.97	< 0.8	4.4	
Medium cutting (High precision)		DCGT	11T301-MS	●	●			11.6	9.525	3.97	0.10	4.4	
			11T302-MS	●	●			11.6	9.525	3.97	0.20	4.4	
			11T304-MS	●	●			11.6	9.525	3.97	0.40	4.4	
Medium cutting (Ultra-precision)		DCGT	11T301MFN-MS	●	●			11.6	9.525	3.97	< 0.1	4.4	
			11T302MFN-MS	●	●			11.6	9.525	3.97	< 0.2	4.4	
			11T304MFN-MS	●	●			11.6	9.525	3.97	< 0.4	4.4	
Finishing (High precision)		DCGT	070201-VP1	●	●	●	●	7.8	6.35	2.38	0.10	2.8	
			070202-VP1	●	●	●	●	7.8	6.35	2.38	0.20	2.8	
			070204-VP1	●	●	●	●	7.8	6.35	2.38	0.40	2.8	
			11T301-VP1	●	●			11.6	9.525	3.97	0.10	4.4	
			11T302-VP1	●	●	●	●	11.6	9.525	3.97	0.20	4.4	
			11T304-VP1	●	●	●	●	11.6	9.525	3.97	0.40	4.4	
Finishing (Ultra-precision)		DCGT	070201MFN-VP1	●	●			7.8	6.35	2.38	< 0.10	2.8	
			070202MFN-VP1	●	●			7.8	6.35	2.38	< 0.20	2.8	
			070204MFN-VP1	●	●			7.8	6.35	2.38	< 0.40	2.8	
			11T301MFN-VP1	●	●			11.6	9.525	3.97	< 0.10	4.4	
			11T302MFN-VP1	●	●			11.6	9.525	3.97	< 0.20	4.4	
			11T304MFN-VP1	●	●			11.6	9.525	3.97	< 0.40	4.4	
Finishing (High precision)		TCGT	0802003R-KF					8.15	4.76	2.38	0.03	2.38	
			080201R-KF					8.0	4.76	2.38	0.10	2.38	
			080202R-KF					7.7	4.76	2.38	0.20	2.38	
			0802003L-KF					8.15	4.76	2.38	0.03	2.38	
			080201L-KF					8.0	4.76	2.38	0.10	2.38	
			080202L-KF					7.7	4.76	2.38	0.20	2.38	

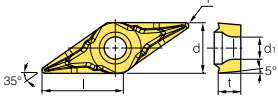
●: Stock item

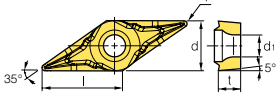
Insert

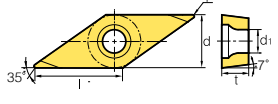
Type	C/B	Designation	Coated					Uncoated	Dimensions (mm)					Configuration
	Picture		PC5300	PC8105	PC8110	PC8115	H01	l	Ød	t	r	Ød ₁		
Finishing (High precision)		TCGT	110201-FS	●	●			9.3	6.35	2.38	0.10	2.8		
			110202-FS	●	●			9.1	6.35	2.38	0.20	2.8		
			110204-FS	●	●			8.6	6.35	2.38	0.40	2.8		
Finishing (Ultra-precision)		TCGT	110201MFN-FS					9.3	6.35	3.18	< 0.1	3.4		
			110202MFN-FS					9.1	6.35	3.18	< 0.2	3.4		
			110204MFN-FS					8.6	6.35	3.18	< 0.4	3.4		
Finishing (High precision)		VBGT	1103003R-KF	●	●			7.8	6.35	2.38	0.03	2.8		
			110301R-KF	●	●			7.8	6.35	2.38	0.10	2.8		
			110302R-KF	●	●			7.8	6.35	2.38	0.20	2.8		
			1103003L-KF	●	●			11.6	9.525	3.97	0.03	4.4		
			110301L-KF	●	●			11.6	9.525	3.97	0.10	4.4		
			110302L-KF	●	●			11.6	9.525	3.97	0.20	4.4		
Medium to finishing (High precision)		VBGT	113003R-KM	●	●			7.8	6.35	2.38	0.03	2.8		
			110301R-KM	●	●			7.8	6.35	2.38	0.10	2.8		
			110302R-KM	●	●			7.8	6.35	2.38	0.20	2.8		
			1103003L-KM	●	●			11.6	9.525	3.97	0.03	4.4		
			110301L-KM	●	●			11.6	9.525	3.97	0.10	4.4		
			110302L-KM	●	●			11.6	9.525	3.97	0.20	4.4		
Finishing (High precision)		VBGT	110301-FS	●	●			11.0	6.35	3.18	0.10	2.8		
			110302-FS	●	●			11.0	6.35	3.18	0.20	2.8		
			110304-FS	●	●			11.0	6.35	3.18	0.40	2.8		
			160401-FS	●	●			16.3	9.525	4.76	0.10	4.4		
			160402-FS	●	●			16.1	9.525	4.76	0.20	4.4		
			160404-FS	●	●			15.7	9.525	4.76	0.40	4.4		
Finishing (Ultra-precision)		VBGT	110301MFN-FS					10.8	6.35	3.18	< 0.1	2.8		
			110302MFN-FS					10.6	6.35	3.18	< 0.2	2.8		
			110304MFN-FS					11.4	6.35	3.18	< 0.4	2.8		
			160401MFN-FS					16.3	9.525	4.76	< 0.1	4.4		
			160402MFN-FS					16.1	9.525	4.76	< 0.2	4.4		
			160404MFN-FS					15.7	9.525	4.76	< 0.4	4.4		
Finishing (High precision)		VCGT	1103003R-KF					11.0	6.35	3.18	0.03	2.8		
			110301R-KF					11.0	6.35	3.18	0.10	2.8		
			110302R-KF					11.0	6.35	3.18	0.20	2.8		
			1103003L-KF					11.0	6.35	3.18	0.03	2.8		
			110301L-KF					11.0	6.35	3.18	0.10	2.8		
			110302L-KF					11.0	6.35	3.18	0.20	2.8		

●: Stock item











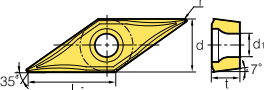

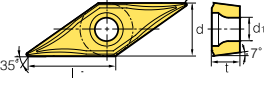
Insert

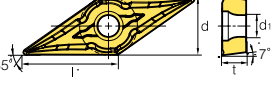
Type	C/B	Designation	Coated					Uncoated					Configuration
	Picture		PC5300	PC8105	PC8110	PC8115	H01	l	Ød	t	r	Ød ₁	
Finishing (Ultra-precision)		VCET	1103005MFR-KF	●	●			11.0	6.35	3.18	<0.05	2.8	
			110301MFR-KF	●	●			11.0	6.35	3.18	<0.10	2.8	
			110302MFR-KF	●	●			11.0	6.35	3.18	<0.20	2.8	
			1103005MFL-KF	●	●			11.0	6.35	3.18	<0.05	2.8	
			110301MFL-KF	●	●			11.0	6.35	3.18	<0.10	2.8	
			110302MFL-KF	●	●			11.0	6.35	3.18	<0.20	2.8	
Medium to finishing (High precision)		VCGT	1103003R-KM					11.0	6.35	3.18	0.03	2.8	
			110301R-KM					11.0	6.35	3.18	0.10	2.8	
			110302R-KM					11.0	6.35	3.18	0.20	2.8	
			1103003L-KM					11.0	6.35	3.18	0.03	2.8	
			110301L-KM					11.0	6.35	3.18	0.10	2.8	
			110302L-KM					11.0	6.35	3.18	0.20	2.8	
Medium to finishing (Ultra-precision)		VCET	1103005MFR-KM	●	●			11.0	6.35	3.18	<0.05	2.8	
			110301MFR-KM	●	●			11.0	6.35	3.18	<0.10	2.8	
			110302MFR-KM	●	●			11.0	6.35	3.18	<0.20	2.8	
			11T3005MFL-KM	●	●			11.0	6.35	3.18	<0.05	2.8	
			11T301MFL-KM	●	●			11.0	6.35	3.18	<0.10	2.8	
			11T302MFL-KM	●	●			11.0	6.35	3.18	<0.20	2.8	
Finishing (High precision)		VCGT	110301-FS	●	●			11.0	6.35	3.18	0.10	2.8	
			110302-FS	●	●			11.0	6.35	3.18	0.20	2.8	
			110304-FS	●	●			11.0	6.35	3.18	0.40	2.8	
			160401-FS	●	●			16.3	9.525	4.76	0.10	4.4	
			160402-FS	●	●			16.1	9.525	4.76	0.20	4.4	
			160404-FS	●	●			15.7	9.525	4.76	0.40	4.4	
Finishing (Ultra-precision)		VCGT	110301MFN-FS					10.8	6.35	3.18	< 0.1	2.8	
			110302MFN-FS					10.6	6.35	3.18	< 0.2	2.8	
			110304MFN-FS					11.4	6.35	3.18	< 0.4	2.8	
			160401MFN-FS					16.3	9.525	4.76	< 0.1	4.4	
			160402MFN-FS					16.1	9.525	4.76	< 0.2	4.4	
			160404MFN-FS					15.7	9.525	4.76	< 0.4	4.4	
Medium cutting (High precision)		VCGT	110301-MS	●	●			10.8	6.35	3.18	0.10	2.8	
			110302-MS	●	●			10.6	6.35	3.18	0.20	2.8	
			110304-MS	●	●			11.4	6.35	3.18	0.40	2.8	
Medium cutting (Ultra-precision)		VCGT	110301MFN-MS	●	●			10.8	6.35	3.18	< 0.1	2.8	
			110302MFN-MS	●	●			10.6	6.35	3.18	< 0.2	2.8	
			110304MFN-MS	●	●			11.4	6.35	3.18	< 0.4	2.8	

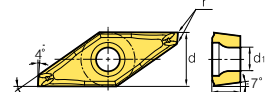
●: Stock item

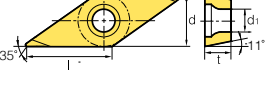

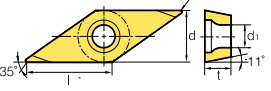
Insert

Type	C/B		Designation	Coated					Uncoated	Dimensions (mm)					Configuration
	Picture			PC5300	PC8105	PC8110	PC8115	H01	l	Ød	t	r	Ød ₁		
Finishing (High-precision)		VCGT	110301-VP1	●	●	●	●	●	11.0	6.35	3.18	0.10	2.8		
			110302-VP1	●	●	●	●	●	11.0	6.35	3.18	0.20	2.8		
			110304-VP1	●	●	●	●	●	11.0	6.35	3.18	0.40	2.8		
Finishing (Ultra-precision)		VCGT	110301MFN-VP1	●	●				11.0	6.35	3.18	<0.10	2.8		
			110302MFN-VP1	●	●				11.0	6.35	3.18	<0.20	2.8		
			110304MFN-VP1	●	●				11.0	6.35	3.18	<0.40	2.8		
Medium cutting (Ultra-precision)		VCGT	1203008FN-MS	●	●				11.0	7.50	3.00	<0.08	2.8		
			120301FN-MS	●	●				11.0	7.50	3.00	<0.10	2.8		
			120302FN-MS	●	●				11.0	7.50	3.00	<0.20	2.8		
			120304FN-MS	●	●				11.0	7.50	3.00	<0.40	2.8		
Finishing (Ultra-precision)	 채퍼타입	VCGX	120300MFR-VP1	●	●				11.0	7.50	3.18	0.00	2.8		
			120301MFR-VP1	●	●				11.0	7.50	3.18	<0.10	2.8		
			120302MFR-VP1	●	●				11.0	7.50	3.18	<0.20	2.8		
			120304MFR-VP1	●	●				11.0	7.50	3.18	<0.40	2.8		
			120308MFR-VP1	●	●				11.0	7.50	3.18	<0.80	2.8		
Finishing (High-precision)		VPGT	080201R-KF	●	●				8.0	4.76	2.38	0.1	2.3		
			080202R-KF	●	●				8.0	4.76	2.38	0.2	2.3		
			1103003R-KF	●	●				11.0	6.35	3.18	0.03	2.8		
			110301R-KF	●	●				11.0	6.35	3.18	0.1	2.8		
			110302R-KF	●	●				11.0	6.35	3.18	0.2	2.8		
			080201L-KF	●	●				8.0	4.76	2.38	0.1	2.3		
			080202L-KF	●	●				8.0	4.76	2.38	0.2	2.3		
			1103003L-KF	●	●				11.0	6.35	3.18	0.03	2.8		
			110301L-KF	●	●				11.0	6.35	3.18	0.1	2.8		
110302L-KF	●	●				11.0	6.35	3.18	0.2	2.8					
Finishing (Ultra-precision)		VPET	0802005MFR-KF	●	●				8.0	6.35	2.38	<0.05	2.3		
			080201MFR-KF	●	●				8.0	6.35	2.38	<0.10	2.3		
			080202MFR-KF	●	●				8.0	6.35	2.38	<0.20	2.3		
			0802005MFL-KF	●	●				8.0	6.35	2.38	<0.05	2.3		
			080201MFL-KF	●	●				8.0	6.35	2.38	<0.10	2.3		
			080202MFL-KF	●	●				8.0	6.35	2.38	<0.20	2.3		

●: Stock item

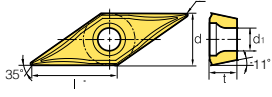

Insert

Type	C/B	Designation	Coated					Uncoated					Configuration	
	Picture		PC5300	PC8105	PC8110	PC8115	H01	l	Ød	t	r	Ød ₁		
Medium to finishing (High precision)		VPGT	080201R-KM	●	●				8.0	4.76	2.38	0.1	2.3	
			080202R-KM	●	●				8.0	4.76	2.38	0.2	2.3	
			1103003R-KM	●	●				11.0	6.35	3.18	0.03	2.8	
			110301R-KM	●	●				11.0	6.35	3.18	0.1	2.8	
			110302R-KM	●	●				11.0	6.35	3.18	0.2	2.8	
			080201L-KM	●	●				8.0	4.76	2.38	0.1	2.3	
			080202L-KM	●	●				8.0	4.76	2.38	0.2	2.3	
			1103003L-KM	●	●				11.0	6.35	3.18	0.03	2.8	
			110301L-KM	●	●				11.0	6.35	3.18	0.1	2.8	
			110302L-KM	●	●				11.0	6.35	3.18	0.2	2.8	
Medium to finishing (Ultra-precision)		VPET	0802005MFR-KM	●	●				8.0	6.35	3.18	<0.05	2.8	
			080201MFR-KM	●	●				8.0	6.35	3.18	<0.10	2.8	
			080202MFR-KM	●	●				8.0	6.35	3.18	<0.20	2.8	
			0802005MFL-KM	●	●				8.0	6.35	3.18	<0.05	2.8	
			080201MFL-KM	●	●				8.0	6.35	3.18	<0.10	2.8	
			080202MFL-KM	●	●				8.0	6.35	3.18	<0.20	2.8	
Medium cutting (High precision)		VPGT	110301-VP1	●	●	●	●	●	11.0	6.35	3.18	0.10	2.8	
			110302-VP1	●	●	●	●	●	11.0	6.35	3.18	0.20	2.8	
			110304-VP1	●	●	●	●	●	11.0	6.35	3.18	0.40	2.8	
Medium cutting (Ultra-precision)		VPGT	110301MFN-VP1	●	●				11.0	6.35	3.18	<0.10	2.8	
			110302MFN-VP1	●	●				11.0	6.35	3.18	<0.20	2.8	
			110304MFN-VP1	●	●				11.0	6.35	3.18	<0.40	2.8	

●: Stock item

Available tool holders

Holders

SCACR/L

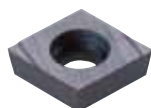

CC□T

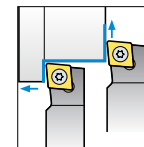
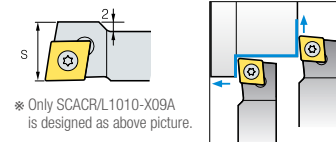
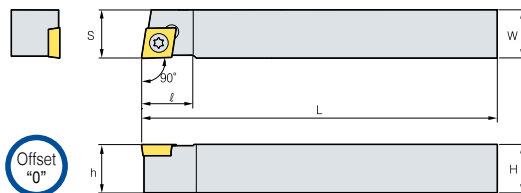

90°

• R type insert

Designation	Stock		Dimensions (mm)							Insert	Screw	Wrench
	R	L	H	W	L	S	h	ℓ				
SCACR/L	0808-X06A	●	●	8	8	120	8	8	10	CC□T0602□□	FTKA02565	TW07P
	1010-X06A	●	●	10	10	120	10	10	10			
	1010-X09A	●	●	10	10	120	12	10	13			
	1212-X09A	●	●	12	12	120	12	12	16	CC□T09T3□□	FTKA0410	TW15P
	1616-X09A	●	●	16	16	120	16	16	16			

SCLCR/L

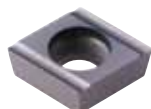

CC□T

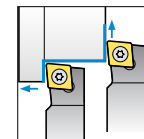
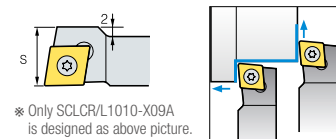
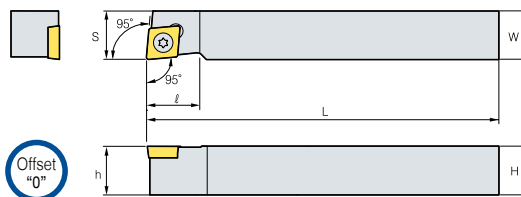

95°

• R type insert

Designation	Stock		Dimensions (mm)							Insert	Screw	Wrench
	R	L	H	W	L	S	h	ℓ				
SCLCR/L	0808-X06A	●	●	8	8	120	8	8	10	CC□T0602□□	FTKA02565	TW07P
	1010-X06A	●	●	10	10	120	10	10	10			
	1010-X09A	●	●	10	10	120	12	10	13			
	1212-X09A	●	●	12	12	120	12	12	16	CC□T09T3□□	FTKA0410	TW15P
	1616-X09A	●	●	16	16	120	16	16	16			

SDJCR/L



DC□T

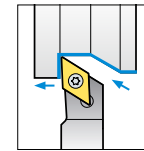
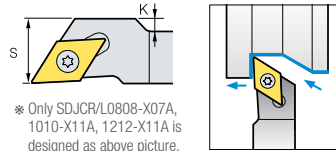
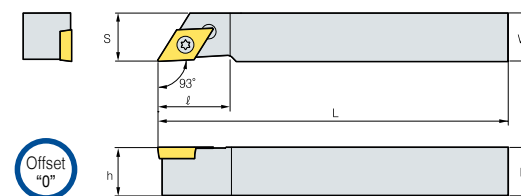

93°

• R type insert

Designation	Stock		Dimensions (mm)							Insert	Screw	Wrench	
	R	L	H	W	L	S	h	K	ℓ				
SDJCR/L	0808-X07A	●	●	8	8	120	10	8	2	18	DC□T0702□□	FTKA02565	TW07P
	1010-X07A	●	●	10	10	120	10	10	-	15			
	1010-X11A	●	●	10	10	120	14	10	4	18			
	1212-X11A	●	●	12	12	120	14	12	2	18	DC□T11T3□□	FTKA0410	TW15P
	1616-X11A	●	●	16	16	120	16	16	-	22			

●: Stock item



Holders

SDNCN



DC□T

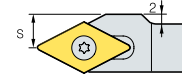
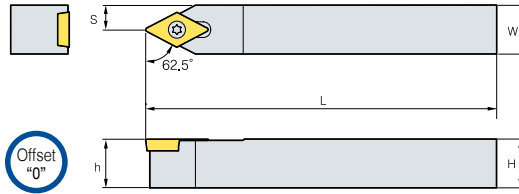

※ Only SDNCN1010-X11A is designed as above picture.

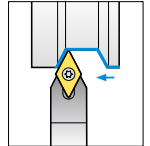

62.5°

• R type insert

Designation	Stock	Dimensions (mm)						Insert	Screw	Wrench
		H	W	L	S	h				
SDNCN	0808-X07A	●	8	8	120	4	8	DC□T0702□□	FTKA02565	TW07P
	1010-X07A	●	10	10	120	5	10			
	1010-X11A	●	10	10	120	7	10	DC□T11T3□□	FTKA0410	TW15P
	1212-X11A	●	12	12	120	6	12			
1616-X11A	●	16	16	120	8	16				

STACR/L

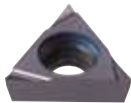

TC□T

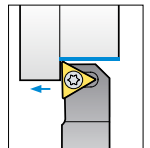
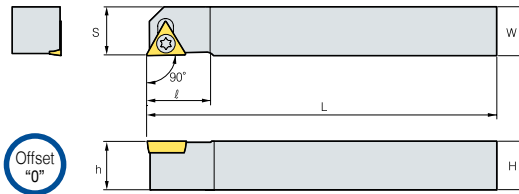

90°

• R type insert

Designation	Stock		Dimensions (mm)							Insert	Screw	Wrench	
	R	L	H	W	L	S	h	K	ℓ				
STACR/L	0808-X08A	●	●	8	8	120	8	8	1	18	TC□T0802□□	FTKA0206	TW06P
	1010-X08A	●	●	10	10	120	10	10	3	15			

SVACR/L



VC□□

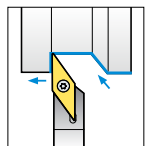
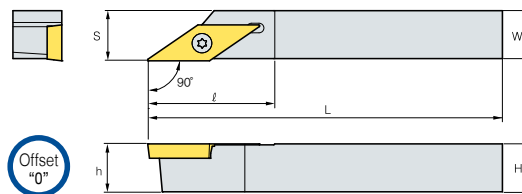

90°

• R type insert

Designation	Stock		Dimensions (mm)							Insert	Screw	Wrench
	R	L	H	W	L	S	h	ℓ				
SVACR/L	0808-X12A	●	●	8	8	120	8.5	8	26	VC□T1203□□	FTKA02565	TW07P
	1010-X12A	●	●	10	10	120	10.5	10	26			
	1212-X12A	●	●	12	12	120	12.5	12	26			
	1616-X12A	●	●	16	16	120	16.5	16	26			
SVACR/L	0808-X12C	●	●	8	8	120	8.5	8	26	VC□X1203□□	FTKA02565	TW07P
	1010-X12C	●	●	10	10	120	10.5	10	26			
	1212-X12C	●	●	12	12	120	12.5	12	26			
	1616-X12C	●	●	16	16	120	16.5	16	26			

●: Stock item

Holders

SVAPR/L



VP□T

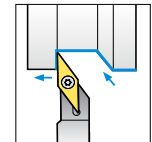
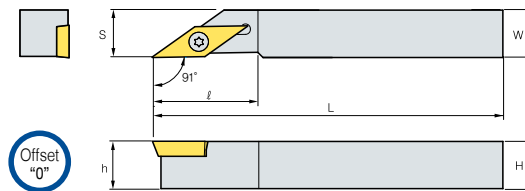

91°

• R type insert

Designation	Stock		Dimensions (mm)							Insert	Screw	Wrench
	R	L	H	W	L	S	h	ℓ				
SVAPR/L	0808-X11A	●	●	8	8	120	8	8	22	VP□T1103□□	FKTA02565	TW07P
	1010-X11A	●	●	10	10	120	10	10	22			
	1212-X11A	●	●	12	12	120	12	12	22			
	1616-X11A	●	●	16	16	120	16	16	24			

SVJBR/L



VB□T

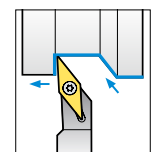
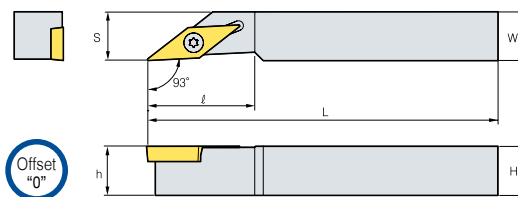

• R type insert

Designation	Stock		Dimensions (mm)							Insert	Screw	Wrench
	R	L	H	W	L	S	h	ℓ				
SVJBR/L	1010-X11A	●	●	10	10	120	10	10	22	VB□T1103□□	FKTA02565	TW07P
	1212-X11A	●	●	12	12	120	12	12	22			
	1616-X11A	●	●	16	16	120	16	16	24			

SVJCR/L



VC□T

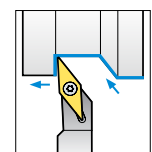
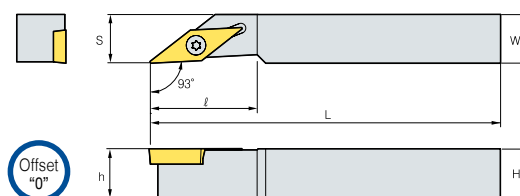

93°

• R type insert

Designation	Stock		Dimensions (mm)							Insert	Screw	Wrench
	R	L	H	W	L	S	h	ℓ				
SVJCR/L	1010-X11A	●	●	10	10	120	10	10	22	VC□T1103□□	FKTA02565	TW07P
	1212-X11A	●	●	12	12	120	12	12	22			
	1616-X11A	●	●	16	16	120	16	16	24			
	0810-X12A	●	●	8	10	120	10	8	26	VC□T1203□□	FKTA02565	TW07P
	1010-X12A	●	●	10	10	120	10	10	26			
	1212-X12A	●	●	12	12	120	12	12	26			
	1616-X12A	●	●	16	16	120	16	16	26			
SVJCR/L	0810-X12C	●	●	8	10	120	10	8	26	VC□X1203□□	FKTA02565	TW07P
	1010-X12C	●	●	10	10	120	10	10	26			
	1212-X12C	●	●	12	12	120	12	12	26			
	1616-X12C	●	●	16	16	120	16	16	26			

●: Stock item



Holders

SVJPR/L



VP□T

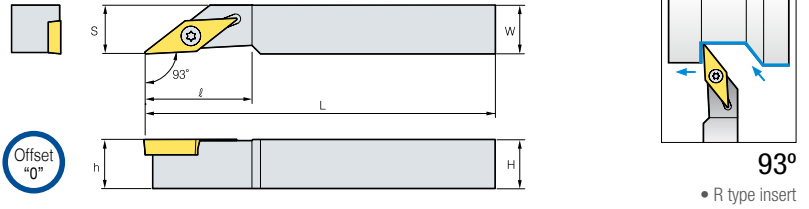

Designation	Stock	Dimensions (mm)								Insert	Screw	Wrench
		R	L	H	W	L	S	h	ℓ			
SVJPR/L	0810-X11A	●	●	8	10	120	8	10	22	VP□T1103□□	FKTA02565	TW07P
	1010-X11A	●	●	10	10	120	10	10	22			
	1212-X11A	●	●	12	12	120	12	12	22			
	1616-X11A	●	●	16	16	120	16	16	24			

SVVPN



VP□T

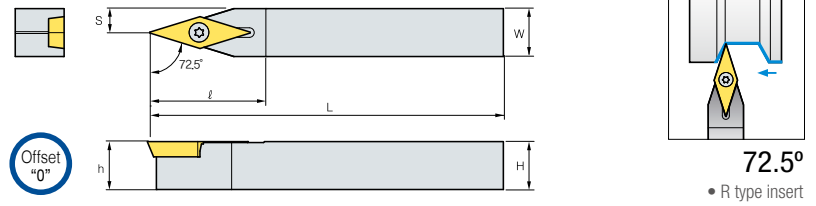

Designation	Stock	Dimensions (mm)								Insert	Screw	Wrench
		H	W	L	S	h	ℓ					
SVVPN	0808-X11A	●	●	8	8	120	4	8	24	VP□T1103□□	FKTA02565	TW07P
	1010-X11A	●	●	10	10	120	5	10	24			
	1212-X11A	●	●	12	12	120	6	12	24			
	1616-X11A	●	●	16	16	120	8	16	28			

●: Stock item



KHP Coolant

(ISO Turning holder)



- 300% increased productivity on Inconel machining vs. low pressure coolant system
- Cooling, tool life, and chip control are improved by the high pressure coolant multi-directional injection system

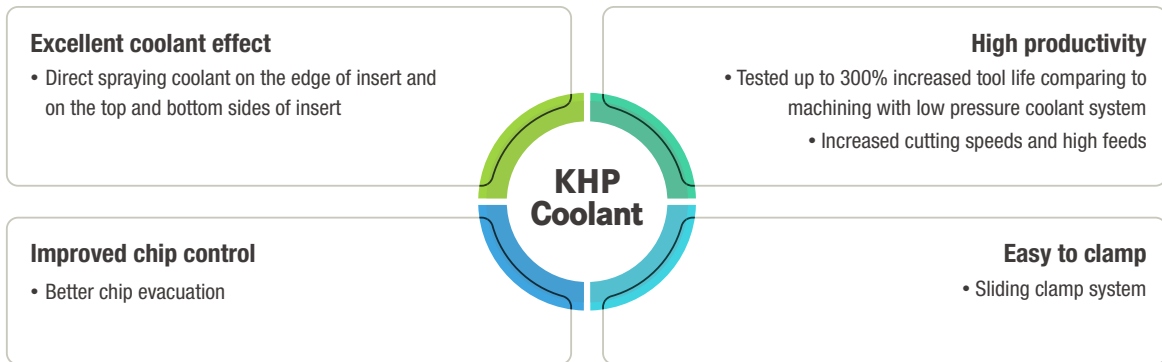

Code system

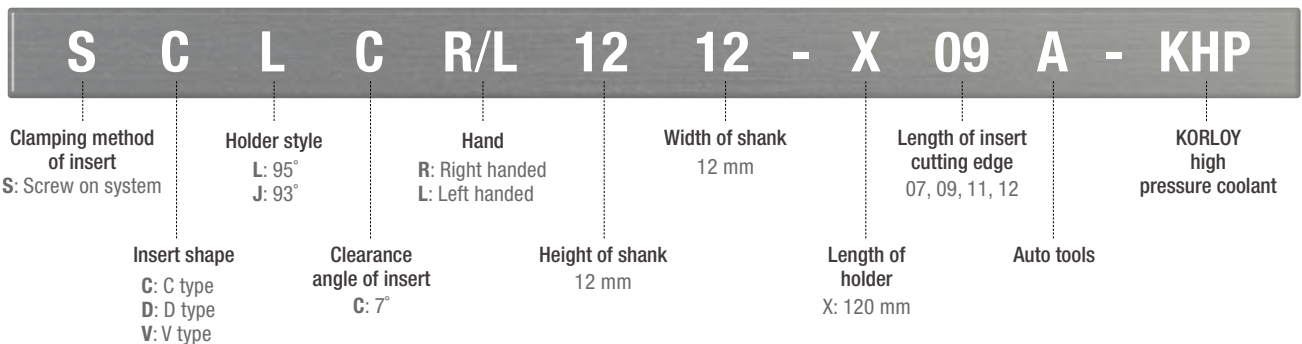



Structure of holder

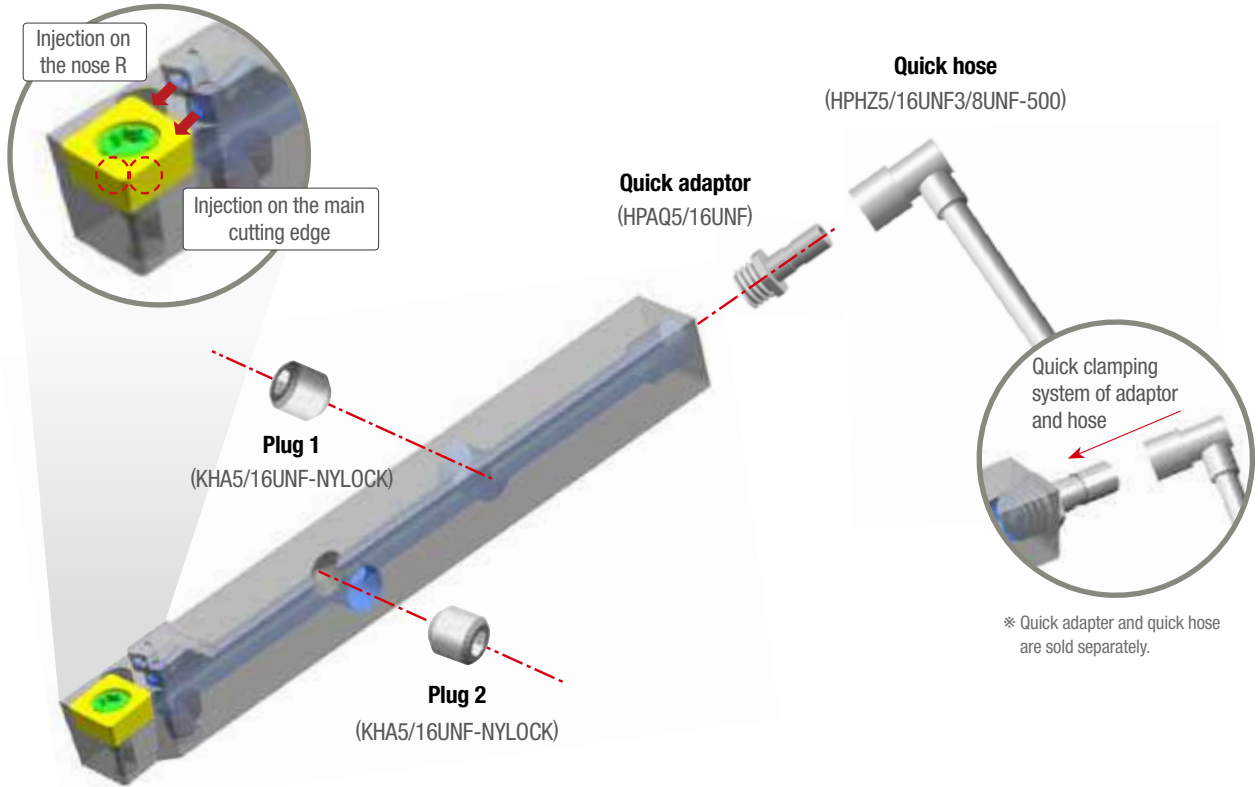

Features

- High pressure coolant holder for high productivity of precise parts machining on automatic lathe
- Improved cooling and chip control due to injecting coolant through two holes to the main cutting edge and nose R concentrically
- Two holes with different injection angles each other increase chip control
- Easy clamping system of quick hose adaptor and quick hose provides convenient using

Injection nozzle

- Optimal coolant nozzle size
- Exact injection point of the major cutting edge and nose R
- Improved chip control due to height difference of injection

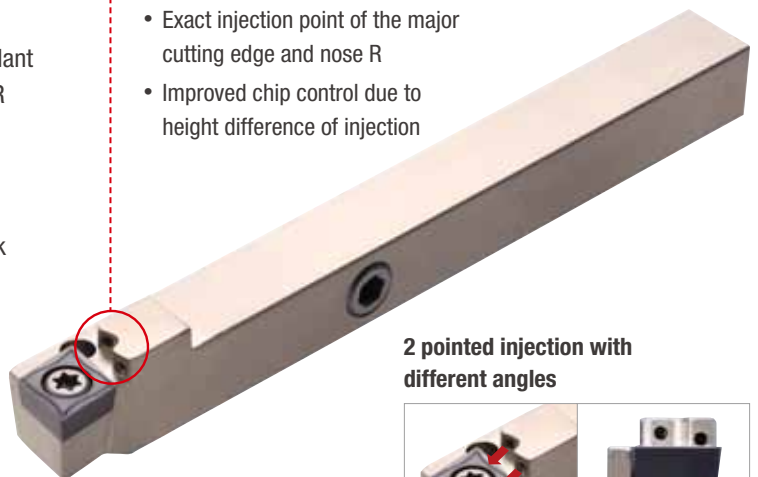

2 pointed injection with different angles

MAX 300 bar

Workpiece	The minimum pressure	The maximum pressure
P	100	300
M	120	
K	110	
N	100	
S	120	



● KHP Coolant cutting performance

Wear resistance

• **Workpiece:** Stainless steel (X5CrNi18-9) • **Insert:** CCGT09T302MFN-VP1 (PC8110) • **Holder:** SCLCR1212-X09A-KHP

Cutting conditions • **vc** = 169 m/min • **fn** = 0.15 mm/rev • **ap** = 0.5 mm, wet (120 bar)

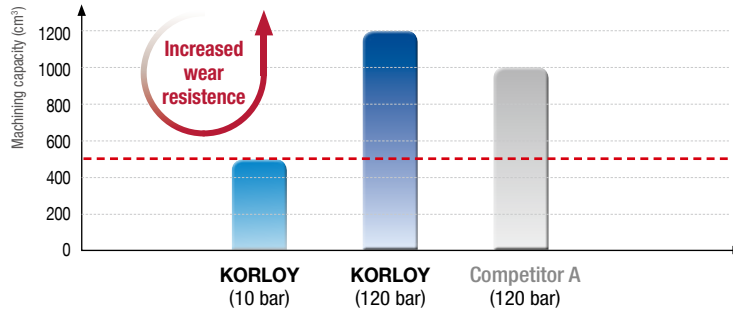

Chip control

• **Workpiece:** Stainless steel (X5CrNi18-9) • **Insert:** CCGT09T302MFN-VP1 (PC8110) • **Holder:** SCLCR1212-X09A-KHP

Cutting conditions • **vc** = 169 m/min • **fn** = 0.15 mm/rev • **ap** = 0.5 mm, wet (120 bar)

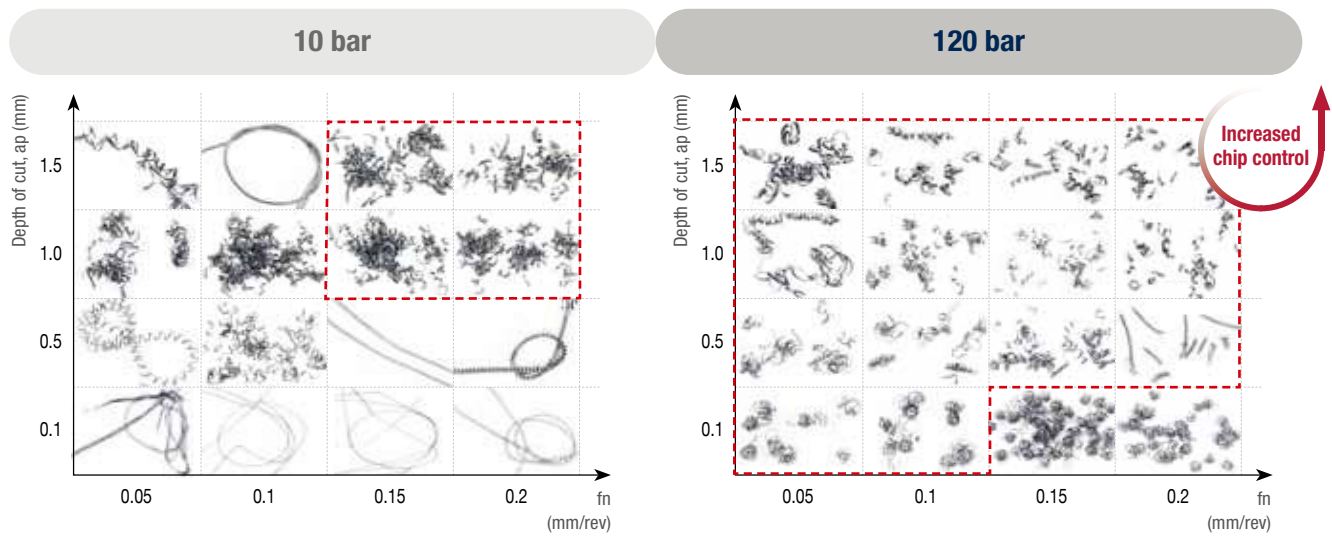

● Parts

Parts	Designation	Shape of parts	
Quick adapter	HPAQ5/16UNF		

● High pressure hose

The shape of the high pressure hose		Length	Standard Q	Standard S
Quick to straight (HPHZ5/16UNF3/8UNF-500)		500 mm	UNF5/16	-



Available tool holders

Holders

SCLCR/L

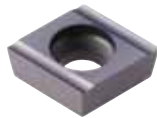

CC□T

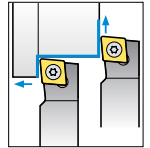
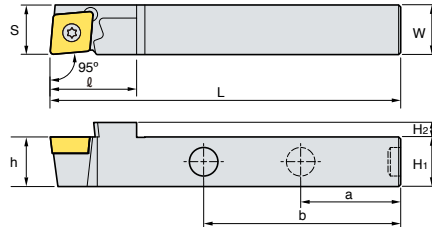

95°

• R type insert

Designation	Stock	Dimensions (mm)										Insert	Screw	Plug	Wrench
		R	L	H ₁	H ₂	W	L	S	h	ℓ	a				
SCLCR/L 1212-X09A-KHP	● ●	12	3.5	12	120	12	12	21	40	70	CC□T09T3□□	FTKA0410	KHA0404-NYLOCK KHA5/16UNF-NYLOCK	TW15P	

Applicable inserts: page. 15~17

SDJCR/L

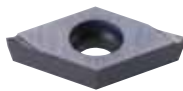

DC□T

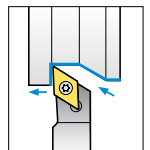
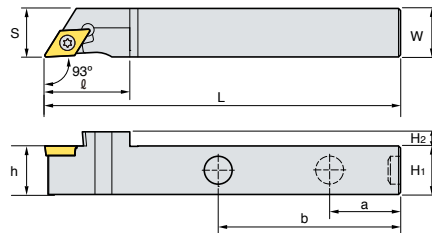

93°

• R type insert

Designation	Stock	Dimensions (mm)										Insert	Screw	Plug	Wrench
		R	L	H ₁	H ₂	W	L	S	h	ℓ	a				
SDJCR/L 1212-X07A-KHP	● ●	12	3.5	12	120	12	12	21	40	70	DC□T0702□□	FTKA02565	KHA0404-NYLOCK KHA5/16UNF-NYLOCK	TW07P	
1212-X11A-KHP	● ●	12	3.5	12	120	14	12	29.8	40	70	DC□T11T3□□	FTKA0408	KHA0404-NYLOCK KHA5/16UNF-NYLOCK	TW15P	

Applicable inserts: page. 17~19

SVJCR/L

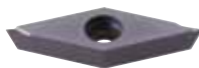

VC□□

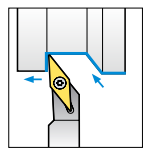
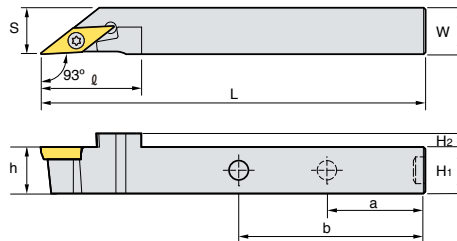

93°

• R type insert

Designation	Stock	Dimensions (mm)										Insert	Screw	Plug	Wrench
		R	L	H ₁	H ₂	W	L	S	h	ℓ	a				
SVJCR/L 1212-X11A-KHP	● ●	12	3.5	12	120	12	12	26	40	70	VC□T1103□□	FTKA02565	KHA0404-NYLOCK KHA5/16UNF-NYLOCK	TW07P	
1212-X12A-KHP	● ●	12	3.5	12	120	12	12	26	40	70	VC□□1203□□	FTKA02565	KHA0404-NYLOCK KHA5/16UNF-NYLOCK	TW07P	

Applicable inserts: page. 20~22

●: Stock item

Blade type

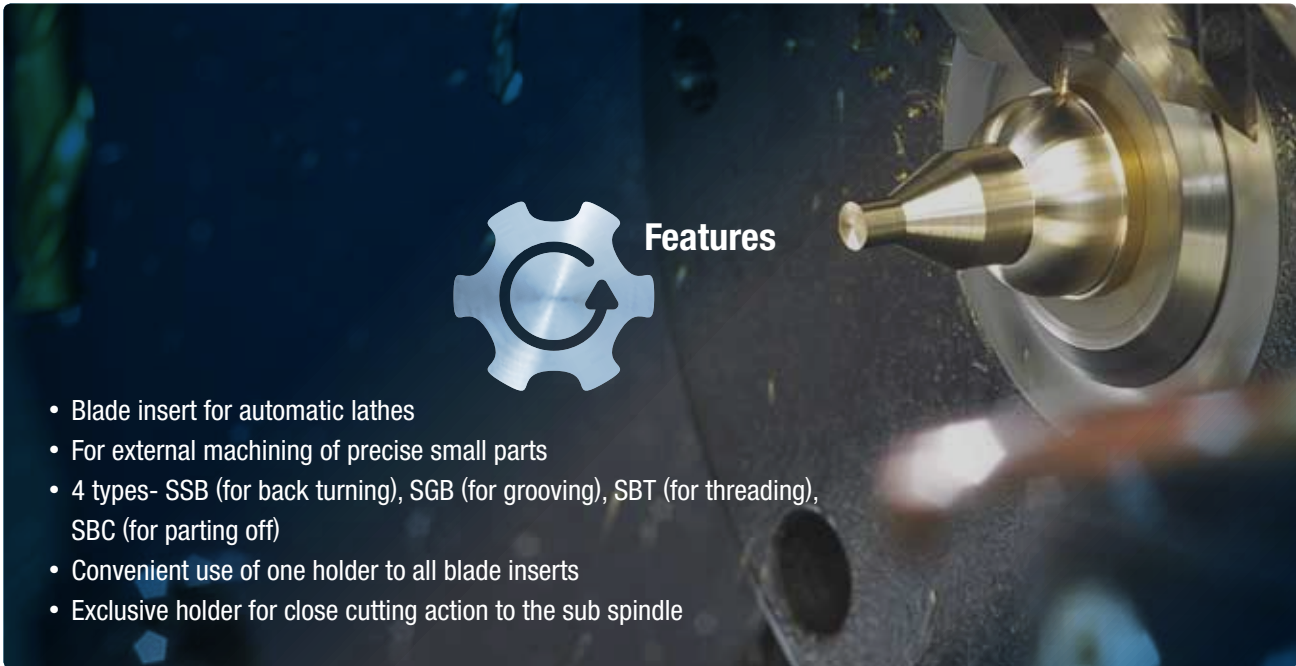

Features

- Blade insert for automatic lathes
- For external machining of precise small parts
- 4 types- SSB (for back turning), SGB (for grooving), SBT (for threading), SBC (for parting off)
- Convenient use of one holder to all blade inserts
- Exclusive holder for close cutting action to the sub spindle

Application example

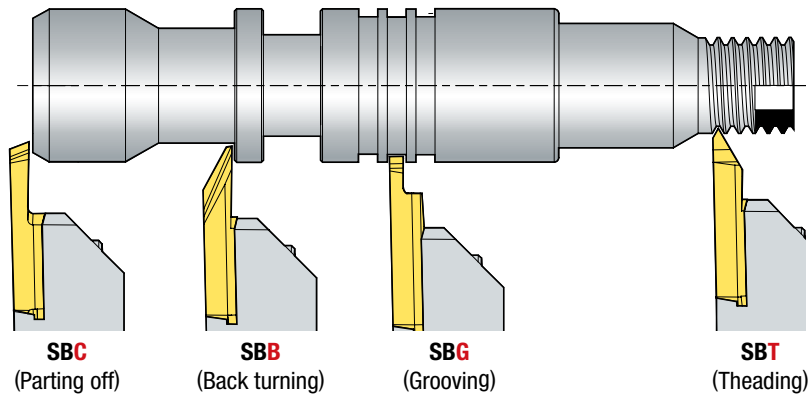

Types of blade insert

SBC - For cut off/Parting

- Cutting width: 0.7~2.0
- D Max.: 16 mm
- Nose R: 0.05 mm



SBB - For back turning

- Approach angle: 59°
- Max. cutting depth: 4 mm
- Nose R: 0.05, 0.1, 0.2 mm



SGB - For grooving

- Width: 0.5~2.5 mm
- Nose R: 0.05 mm



SBT - For threading

- V profile: 60°
- Pitch: 0.2~1.0 mm
- Nose R: 0.05 mm





Code system of auto tools insert

Turning (Back turning)

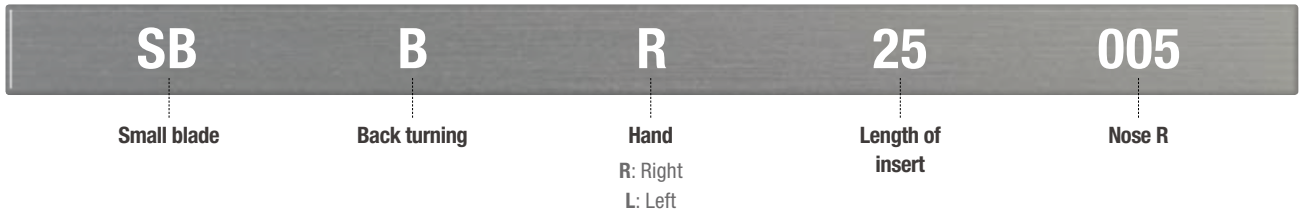

Grooving

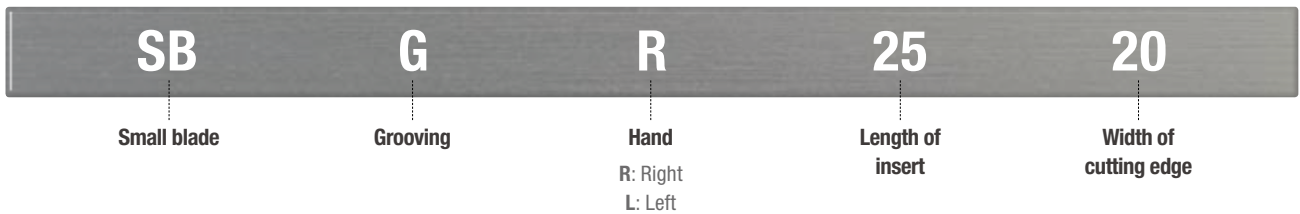

Threading

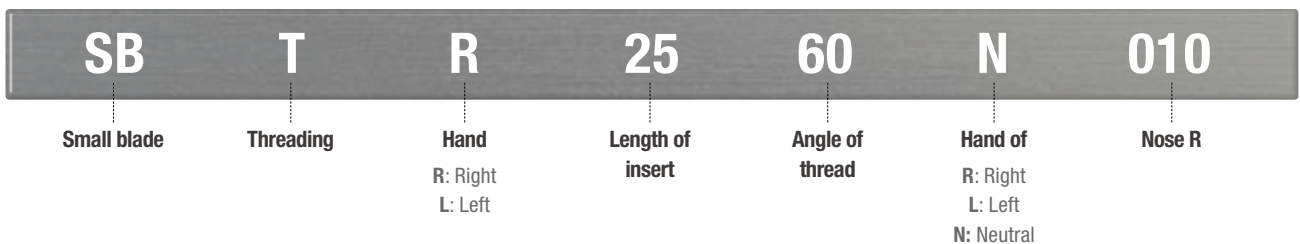

Parting

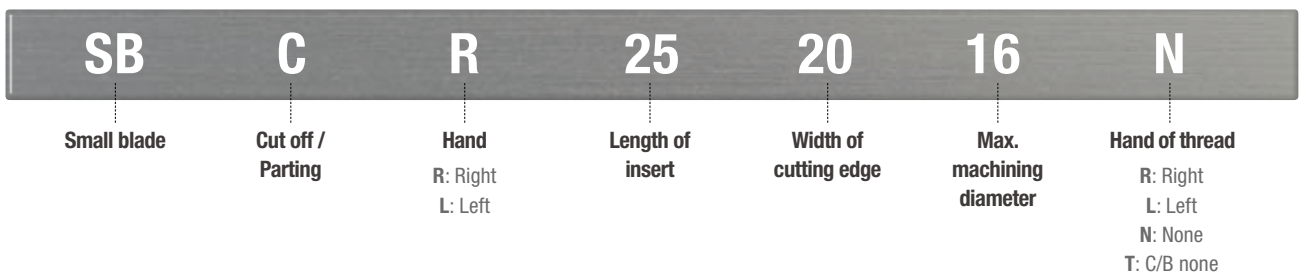

Code system of auto tools holder

Blade

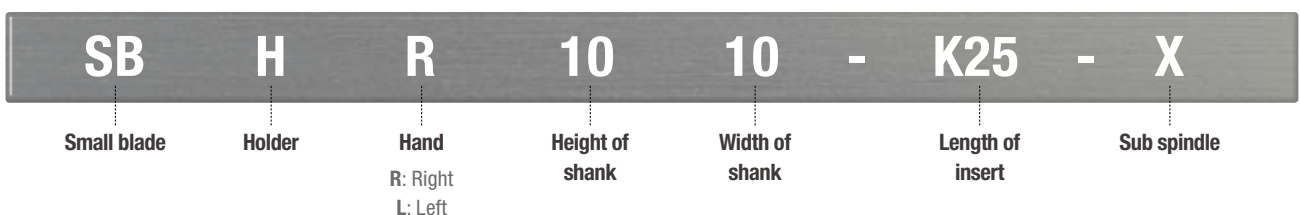

Recommended cutting condition

SBCR Insert

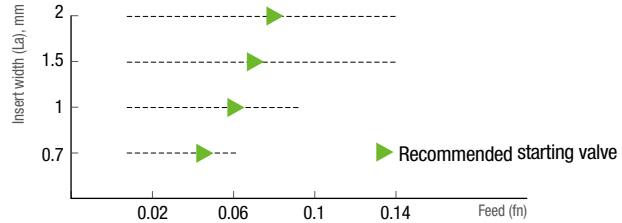

Parting

- When parting with a sub-spindle it is more productive to use a straight cutting edge. This is a more stable parting method and will generate the best surface finish.
- When parting without a sub-spindle we recommend you use an insert with a maximum 15° front angle to minimise the risk of burr and pips on the component.
- When parting off with 15° front angled inserts we recommend reducing the feed by approximately 30%.

SBGR Insert

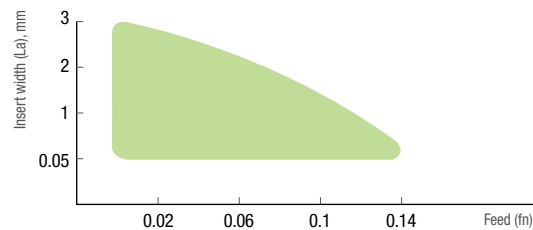

Grooving

- Try not to use a smaller cutting depth than the nose radius. This will generate higher radial forces and will result in inaccurate dimensions.
- Too low cutting speed will result in inadequate tool life and it is advisable to follow cutting speed recommendations

SBBR Insert

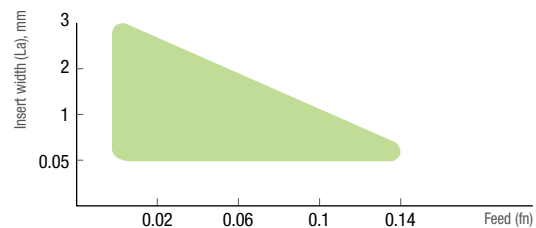

Back Turning

- If running with a cutting depth larger than 0.079 inch we recommend you use the insert with 0.008 inch nose radius.
- When using a large cutting depth it is important to reduce the feed as there is a large amount of pressure on the actual insert tip.
- If a larger cutting depth than 0.118 inch is needed switch to the VCGX inserts which have more edge strength.



Grades and recommended cutting conditions

Workpiece	Grade	Recommended cutting speed, vc (m/min)									
		50	100	150	200	250	300	350	550	600	
P Steel	PC8110		100		200						
	PC5300		80		160						
M Stainless steel	PC8110		90		190						
	PC5300		80		150						
N Non-ferrous metal	PC8110							310		620	
	PC5300						260		520		
S HRSA	PC8110	30	60								
	PC5300	20	50								

* The cutting conditions above is for cutting, grooving and threading and for back turning, 20% lower cutting conditions is recommended.

Easy tool change with constant high precision

Screw holes on both sides

- Easy to exchange inserts → **Improved productivity**

Insert corner change

- Tolerance repetition ± 0.001 within → **Save setting time**

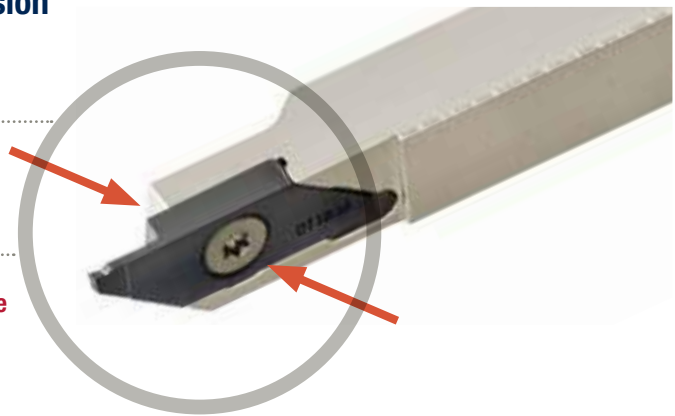

Combination of inserts and holders

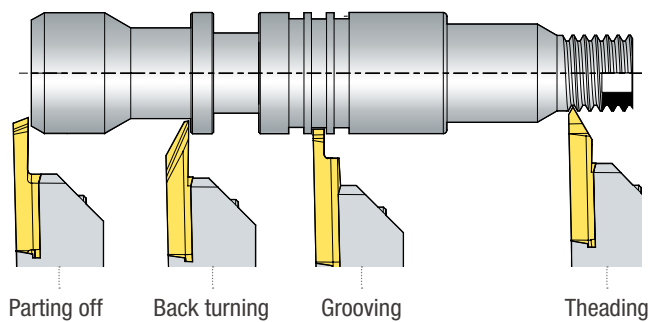

Processed form		Cut off	Back turning	Grooving	Threading
Insert	Designation	SBCR252016-R	SBBR25010	SBGR2515	SBTR2560-R-005
	Nose R	0.05	0.05, 0.1, 0.2	0.05	0.05, 0.1
	Edge width	0.7, 1.0, 1.5, 2.0	3.18	0.5, 1.0, 1.5, 2.0, 2.5	-
Holder	Designation	SBHR1212-K25	SBHR1212-K25	SBHR1212-K25	SBHR1212-K25
	Size	10x10, 12x12, 16x16	10x10, 12x12, 16x16	10x10, 12x12, 16x16	10x10, 12x12, 16x16

● Blade cutting performance

Wear resistance- External machining

• **Workpiece:** Stainless steel (X5CrNi18-9)

• **Cutting conditions** • $vc = 100$ m/min • $fn = 0.14$ mm/rev • $ap = 0.2$ mm, Wet

SBCR252016 (PC8110)

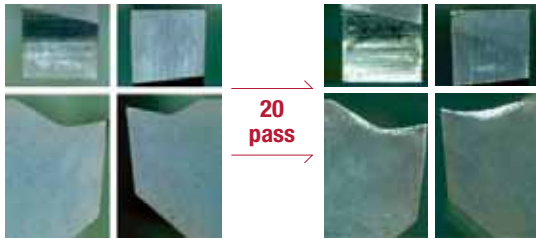

Competitor

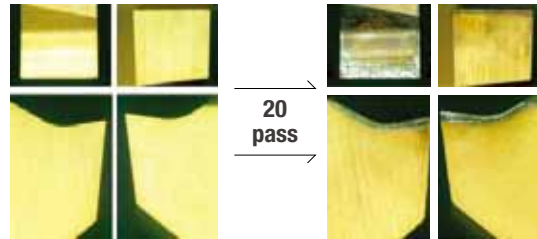

Chip Breaking- External machining

• **Workpiece:** Stainless steel (X5CrNi18-9)

• **Cutting conditions** • $vc = 100$ m/min • $fn = 0.02\sim 0.18$ mm/rev • $ap = 0.5\sim 4.0$ mm, Wet

SBCR252016 (PC8110)

	0.06	0.1	0.14	0.18
4.0	About 165 mm			
2.0	About 170 mm			
0.5	About 200 mm			

Competitor

	0.06	0.1	0.14	0.18
4.0	About 80 mm			
2.0	About 800 mm			
0.5	About 140 mm			





Applicable inserts

Insert

Application	Picture	Designation	Coated				Dimensions (mm)				Configuration	Feed direction	
			PC8110		PC5300		l	α°	t	r			
			R	L	R	L							
Back turning		SBBR/L	25005	●	●	●	●	25	59	3.18	0.05		
			25010	●	●	●	●	25	59	3.18	0.10		
			25020	●	●	●	●	25	59	3.18	0.20		

Application	Picture	Designation	Coated				Dimensions (mm)					Configuration	Feed direction		
			PC8110		PC5300		l	α°	r	La	ar			Dmax	
			R	L	R	L									
Parting off		SBCR/L	250708-N	●	●	●	●	25	0	0.05	0.7	4.3	8		
			251012-N	●	●	●	●	25	0	0.05	1.0	6.3	12		
			251512-N	●	●	●	●	25	0	0.05	1.5	6.3	12		
			252016-N	●	●	●	●	25	0	0.05	2.0	8.3	16		
			250708-R	●	●	●	●	25	15	0.05	0.7	4.3	8		
			251012-R	●	●	●	●	25	15	0.05	1.0	6.3	12		
			251512-R	●	●	●	●	25	15	0.05	1.5	6.3	12		
			252016-R	●	●	●	●	25	15	0.05	2.0	8.3	16		
			250708-L	●	●	●	●	25	15	0.05	0.7	4.3	8		
			251012-L	●	●	●	●	25	15	0.05	1.0	6.3	12		
			251512-L	●	●	●	●	25	15	0.05	1.5	6.3	12		
			252016-L	●	●	●	●	25	15	0.05	2.0	8.3	16		
251012-T	●	●	●	●	25	0	0.05	1.0	6.3	12					
251512-T	●	●	●	●	25	0	0.05	1.5	6.3	12					
252016-T	●	●	●	●	25	0	0.05	2.0	8.3	16					

Application	Picture	Designation	Coated				Dimensions (mm)			Configuration	Feed direction		
			PC8110		PC5300		l	r	La			ar	
			R	L	R	L							
Grooving		SBGR/L	2505	●	●	●	●	25	0.05	0.5	1.35		
			2510	●	●	●	●	25	0.05	1.0	2.75		
			2515	●	●	●	●	25	0.05	1.5	3.75		
			2520	●	●	●	●	25	0.05	2.0	3.75		
			2525	●	●	●	●	25	0.05	2.5	3.75		

●: Stock item

Insert

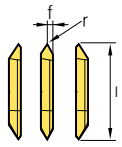
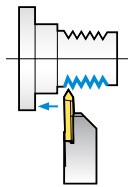
Application	Picture	Designation	Coated				Dimensions (mm)					Configuration	Feed direction	
			PC8110		PC5300		l	r	f	Pitch range				
			R	L	R	L				Min.	Max			
Threading		SBTR/L	2560-N-005	●	●	●	●	25	0.05	1.59	0.2	2.0		
			2560-N-010	●	●	●	●	25	0.10	1.59	1.0	2.0		
			2560-R-005	●	●	●	●	25	0.05	0.60	0.2	1.5		
			2560-R-010	●	●	●	●	25	0.10	0.60	1.0	1.5		
			2560-L-005	●	●	●	●	25	0.05	0.60	0.2	1.5		
			2560-L-010	●	●	●	●	25	0.10	0.60	1.0	1.5		

Available tool holders

Holders

SBHR/L



SBBR SBGR
SBTR SBCR

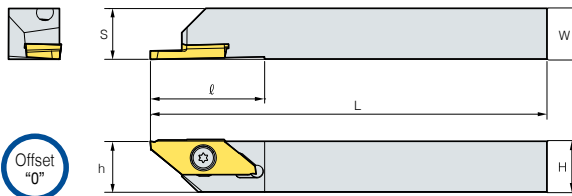

Designation	Stock		Dimensions (mm)							Insert	Screw	Wrench
	R	L	H	W	L	S	h	ℓ				
SBHR/L	1010-K25	●	●	10	10	125	10	10	27	SB □ R/L25	FTKA0409S	TW09P
	1212-K25	●	●	12	12	125	12	12	27			
	1616-K25	●	●	16	16	125	16	16	27			

SBHR/L-X (Sub spindle)



SBBR SBGR
SBTR SBCR

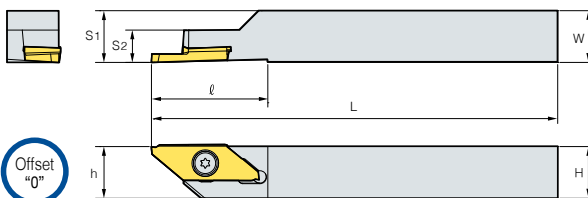

Designation	Stock		Dimensions (mm)							Insert	Screw	Wrench	
	R	L	H	W	L	S ₁	S ₂	h	ℓ				
SBHR/L	1010-K25-X	●	●	10	10	125	10	7.5	10	27	SB □ R/L25	FTKA0409S	TW09P
	1212-K25-X	●	●	12	12	125	12	7.5	12	27			

●: Stock item



Multy utility



Features

- Multifunctional insert for automatic lathes
- For external machining of precise small parts
- 5 types- SB (for back turning), SG (for grooving), ST (for threading), SC (for parting off), SGB (for grooving and back turning)
- Convenient use of one holder to all inserts
- Offset "0" to all ISO type holders

○ Combination of inserts and holders

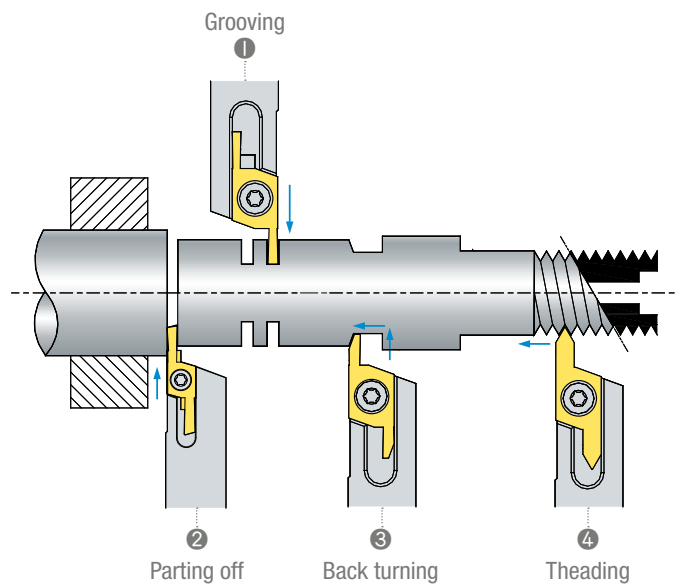

Types of multifunctional insert



Insert code system (Multi utility type)

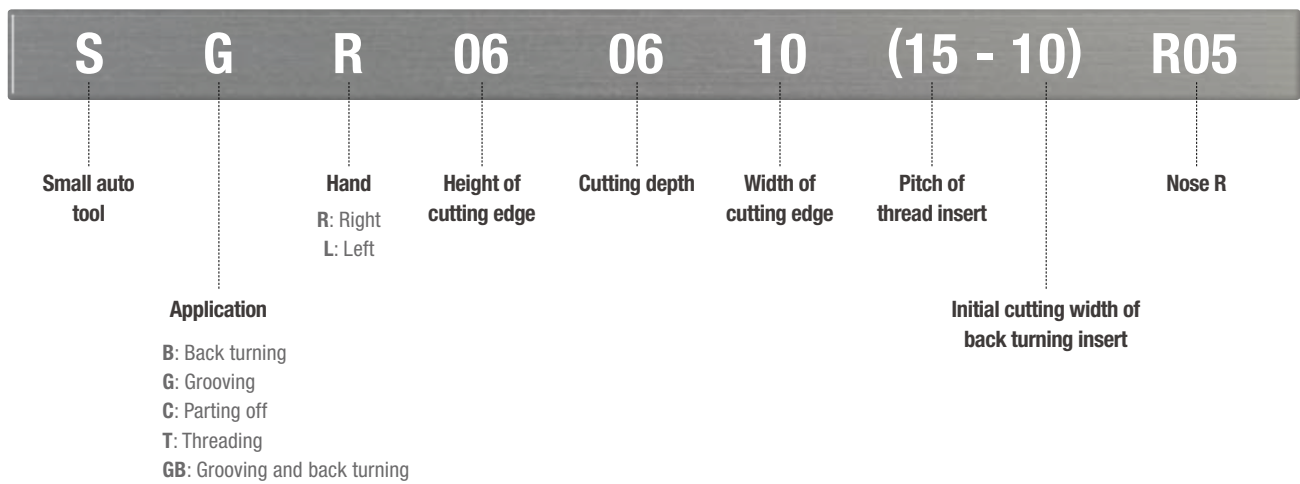

Recommended cutting conditions

Workpiece	Turning		Grooving		Parting off		Back turning	
	Cutting speed, vc (m/min)	Feed, fn (mm/rev)	Cutting speed, vc (m/min)	Feed, fn (mm/rev)	Cutting speed, vc (m/min)	Feed, fn (mm/rev)	Cutting speed, vc (m/min)	Feed, fn (mm/rev)
P Carbon steel	50~150	0.01~0.25	50~150	0.02~0.08	50~150	0.01~0.08	50~150	0.01~0.25
	30~150	0.02~0.25	30~150	0.02~0.08	30~150	0.01~0.08	30~150	0.01~0.25
M Stainless steel	50~120	0.02~0.20	30~120	0.02~0.05	30~120	0.02~0.05	30~120	0.02~0.20
S Non-ferrous metal	70~200	0.03~0.25	70~200	0.03~0.10	70~200	0.03~0.10	70~200	0.03~0.30



Applicable inserts

Insert

Application	Picture	Designation	Coated		Dimensions (mm)							Configuration	Feed Direction
			PC9030		b ₁	b ₂	w	L	r	h	T-MAX		
			R	L									
Back turning		SBR/L 060520-10-R00			1.0	2	8	22	0.00	6	5.5		
		060520-10-R05			1.0	2	8	22	0.05	6	5.5		
		060520-10-R10			1.0	2	8	22	0.10	6	5.5		
		060630-20-R00			2.0	3	8	24	0.00	6	6.5		
		060630-20-R05			2.0	3	8	24	0.05	6	6.5		
		060630-20-R10			2.0	3	8	24	0.10	6	6.5		
		080630-20-R00			2.0	3	8	23	0.00	8	6.5		
		080630-20-R05			2.0	3	8	23	0.05	8	6.5		
		080630-20-R10			2.0	3	8	23	0.10	8	6.5		
		080840-20-R00			2.0	4	8	27	0.00	8	8.5		
		080840-20-R05			2.0	4	8	27	0.05	8	8.5		
		080840-20-R10			2.0	4	8	27	0.10	8	8.5		

Application	Picture	Designation	Coated		Dimensions (mm)							Configuration	Feed Direction
			PC9030		b	w	L	r	h	ØD			
			R	L									
Parting off		SCR/L 060610-R00			1.0	8	24	0.00	6	11			
		060610-R05	●		1.0	8	24	0.05	6	11			
		060610-R10	●		1.0	8	24	0.10	6	11			
		060615-R00			1.5	8	24	0.00	6	11			
		060615-R05	●		1.5	8	24	0.05	6	11			
		060615-R10	●		1.5	8	24	0.10	6	11			
		060620-R00			2.0	8	24	0.00	6	11			
		060620-R05	●		2.0	8	24	0.05	6	11			
		060620-R10	●		2.0	8	24	0.10	6	11			
		081015-R00			1.5	8	31	0.00	8	18			
		081015-R05			1.5	8	31	0.05	8	18			
		081015-R10			1.5	8	31	0.10	8	18			
		081020-R00			2.0	8	31	0.00	8	18			
		081020-R05			2.0	8	31	0.05	8	18			
		081020-R10	●		2.0	8	31	0.10	8	18			
		081025-R00			2.5	8	31	0.00	8	18			
		081025-R05	●		2.5	8	31	0.05	8	18			
		081025-R10	●		2.5	8	31	0.10	8	18			
		081030-R00			-	3.0	8	31	0.00	8			18
		081030-R05	●		3.0	8	31	0.05	8	18			
081030-R10			3.0	8	31	0.10	8	18					

●: Stock item

Insert

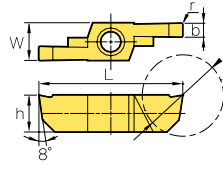
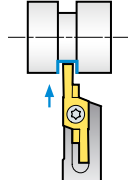
Application	Picture	Designation	Coated		Dimensions (mm)						Configuration	Feed direction
			PC9030		b	w	L	r	h	ØD		
			R	L								
Grooving		SGR/L 060610-R00			1.0	8	24	0.00	6	11		
		060610-R05	●		1.0	8	24	0.05	6	11		
		060610-R10	●		1.0	8	24	0.10	6	11		
		060615-R00			1.5	8	24	0.00	6	11		
		060615-R05	●		1.5	8	24	0.05	6	11		
		060615-R10	●		1.5	8	24	0.10	6	11		
		060620-R00			2.0	8	24	0.00	6	11		
		060620-R05	●		2.0	8	24	0.05	6	11		
		060620-R10	●		2.0	8	24	0.10	6	11		
		081015-R00			1.5	8	31	0.00	8	18		
		081015-R05			1.5	8	31	0.05	8	18		
		081015-R10			1.5	8	31	0.10	8	18		
		081020-R00			2.0	8	31	0.00	8	18		
		081020-R05	●		2.0	8	31	0.05	8	18		
		081020-R10			2.0	8	31	0.10	8	18		
		081025-R00			2.5	8	31	0.00	8	18		
		081025-R05			2.5	8	31	0.05	8	18		
		081025-R10			2.5	8	31	0.10	8	18		
		081030-R00			3.0	8	31	0.00	8	18		
		081030-R05			3.0	8	31	0.05	8	18		
081030-R10			3.0	8	31	0.10	8	18				

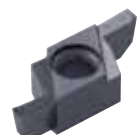
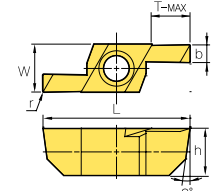
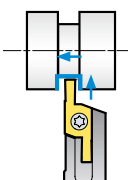
Application	Picture	Designation	Coated		Dimensions (mm)						Configuration	Feed direction
			PC9030		b	w	L	r	h	T-MAX		
			R	L								
Grooving and back turning		SGBR/L 0604520-R00			2.0	8	22	0.00	6	4.5		
		0604520-R05			2.0	8	22	0.05	6	4.5		
		0604520-R10			2.0	8	22	0.10	6	4.5		
		0604525-R00			2.5	8	22	0.00	6	4.5		
		0604525-R05			2.5	8	22	0.05	6	4.5		
		0604525-R10			2.5	8	22	0.10	6	4.5		
		0605530-R00			3.0	8	24	0.00	6	5.5		
		0605530-R05			3.0	8	24	0.05	6	5.5		
		0605530-R10			3.0	8	24	0.10	6	5.5		
		0805525-R00			2.5	8	24	0.00	8	5.5		
		0805525-R05			2.5	8	24	0.05	8	5.5		
		0805525-R10			2.5	8	24	0.10	8	5.5		
		0806530-R00			3.0	8	26	0.00	8	6.5		
		0806530-R05			3.0	8	26	0.05	8	6.5		
		0806530-R10			3.0	8	26	0.10	8	6.5		

●: Stock item



Insert

Application	Picture	Designation	Coated		Dimensions (mm)							Configuration	Feed direction
			PC9030		b	w	L	r	h	T-MAX	Pitch		
			R	L									
Threading		STR/L	06073215		3.2	8	25	0.06	6	7.0	0.5 ~ 1.5		
			06073230		3.2	8	25	0.19	6	7.0	1.5 ~ 3.0		
			08103215		3.2	8	31	0.06	8	10.5	0.5 ~ 1.5		
			08103230		3.2	8	31	0.19	8	10.5	1.5 ~ 3.0		

●: Stock item

Available tool holders

Holder

SXGNR/L



SBR SGBR
SCR STR SGR

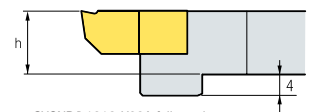
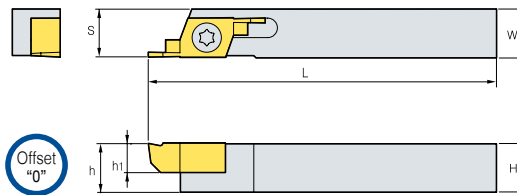

※ SXGNR/L1212-X08A follows the configuration above.

● R type insert

Designation	Stock		Dimensions (mm)						Insert	Screw	Wrench
	R	L	H	W	L	S	h	h ₁			
SXGNR/L	1010-X06A	●	10	10	125	10	10	6	S□R/L 06	FTNA0408	TW15P
	1212-X06A	●	12	12	125	12	12	6			
	1616-X06A	●	16	16	125	16	16	6			
	2020-X06A	●	20	20	125	20	20	6			
SXGNR/L	1212-X08A	●	12	12	130	12	12	8	S□R/L 08	FTNA0411	TW15P
	1616-X08A		16	16	130	16	16	8			
	2020-X08A		20	20	130	20	20	8			

●: Stock item

TBGF



Optimal for automatic machining from stable chip control in TBGF grooving



Features

- Economical 3-cornered insert for precision grooving with small diameter
- Various width of cutting edge (0.33~ 2.50 mm)
- High precision machining due to applying precision ground class insert
- Optimal for automatic machining from stable chip control in TBGF grooving

○ Insert code system

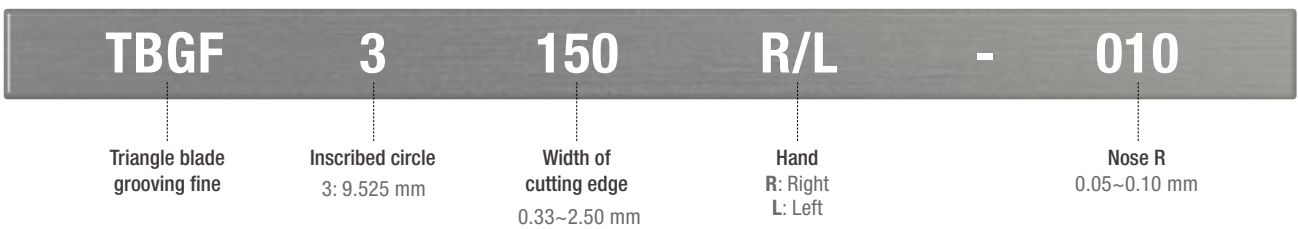

○ Holder code system

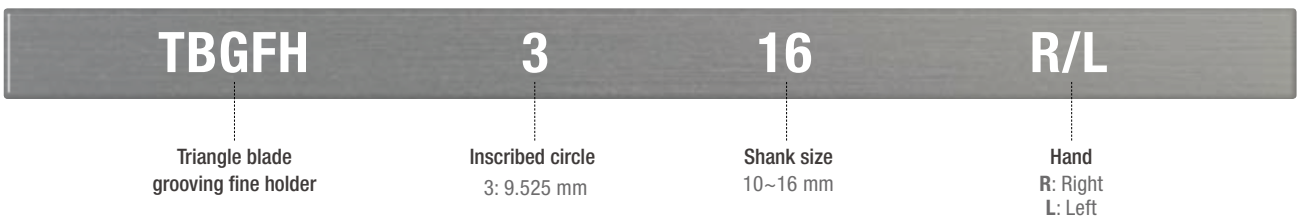



Application range

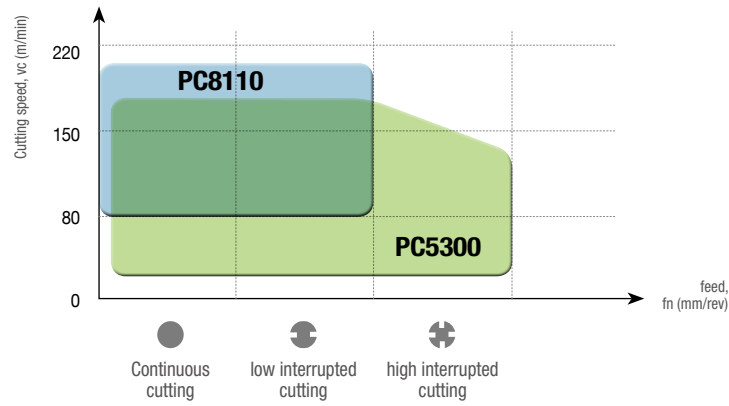



Grades and recommended cutting conditions

Workpiece	Grade	Recommended cutting speed, v_c (m/min)										
		30	60	90	120	150	180	210	240	270	300	
P	Carbon steel	PC8110			90			200				
		PC5300			80			180				
	Alloy steel	PC8110			90			190				
		PC5300			80			160				
M	Stainless steel	PC8110			90			180				
		PC5300			70			150				
K	Cast iron	PC8110			80			170				
		PC5300			70			140				

● Applicable inserts

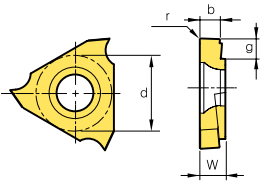
Insert

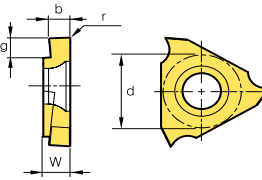
Type	Picture	Designation	Coated		Dimensions (mm)					Configuration			
			PC5300	PC8110	b	g (T-MAX)	r	w	d				
Grooving	 <p>(Right-handed)</p>	TBGF	3033R-005			0.33	0.8	0.05	3.18	9.525			
			3050R-005	●	●	0.50	1.2	0.05	3.18	9.525			
		3075R-010	●	●	0.75	2.0	0.10	3.18	9.525				
		3080R-010			0.80	2.0	0.10	3.18	9.525				
		3100R-010	●	●	1.00	2.0	0.10	3.18	9.525				
		3120R-010	●	●	1.20	2.0	0.10	3.18	9.525				
		3125R-010	●	●	1.25	2.0	0.10	3.18	9.525				
		3140R-010	●	●	1.40	2.0	0.10	3.18	9.525				
		3145R-010	●	●	1.45	2.0	0.10	3.18	9.525				
		3150R-010	●	●	1.50	2.0	0.10	3.18	9.525				
		3175R-010	●	●	1.75	2.0	0.10	3.18	9.525				
		3200R-010	●	●	2.00	2.5	0.10	3.18	9.525				
		3250R-010	●	●	2.50	2.5	0.10	3.18	9.525				
		 <p>(Left-handed)</p>	TBGF	3033L-005			0.33	0.8	0.05	3.18		9.525	
				3050L-005			0.50	1.2	0.05	3.18		9.525	
	3075L-010					0.75	2.0	0.10	3.18	9.525			
	3080L-010					0.80	2.0	0.10	3.18	9.525			
	3100L-010					1.00	2.0	0.10	3.18	9.525			
	3120L-010					1.20	2.0	0.10	3.18	9.525			
	3125L-010					1.25	2.0	0.10	3.18	9.525			
	3140L-010					1.40	2.0	0.10	3.18	9.525			
	3145L-010					1.45	2.0	0.10	3.18	9.525			
	3150L-010					1.50	2.0	0.10	3.18	9.525			
	3175L-010			1.75	2.0	0.10	3.18	9.525					
	3200L-010			2.00	2.5	0.10	3.18	9.525					
3250L-010			2.50	2.5	0.10	3.18	9.525						

●: Stock item



Available tool holders

Holders

TBGFH



TBGF

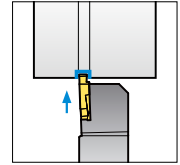

• R type insert

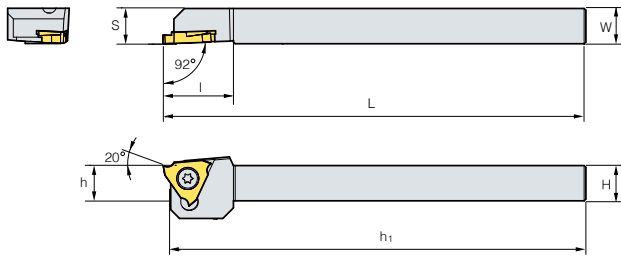

Fig. 1

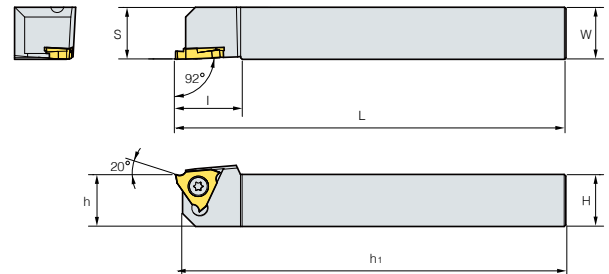

Fig. 2

Designation	Stock		Dimensions (mm)							Insert	Screw	Wrench	Fig.
	R	L	H=h	W	L	l	h ₁	S					
TBGFH	310R/L	●	●	10	10	120	20	5	10	TBGF3□□□R/L-□	FTNA0408	TW15P	1
	312R/L	●	●	12	12	120	20	3	12				
	316R/L	●	●	16	16	120	20	-	16				

●: Stock item

KGT/MGT



- Grooving insert for automatic lathes
- Exclusive holder for automatic lathes
- Economic double sided insert
- Strong clamping system secures stable machining and precision.
- A wide selection of chip breakers according to various cutting conditions such as low/high feed, continuous/interrupted machining, etc.



◉ Chip breaker line-up - KGT Insert

KGMM - L

- Sharp cutting edge
- For low feed machining
- For small diameter parts



KGMM - R

- Reinforced cutting edge
- For high feed machining
- For interrupted cutting

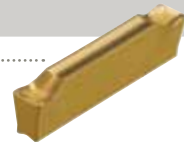

KGMM - T

- Sharp cutting edge
- Stronger chip control
- For turning and grooving

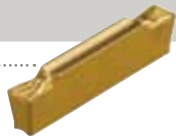

KGMR/L - LP

- Sharp cutting edge
- For low feed machining
- Small diameter component
- Right/Left handed
- Low carbon steel

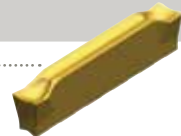

KGMR/L - RP

- Strong cutting edge
- For high feed machining
- For interrupted cutting
- Right/Left handed



KRMN - C

- Improved chip control
- Copying
- Relief





Chip breaker line-up - MGT insert

MGMN - M



- Easier chip control by narrowing chip width with the use of chip breaker on rake surface center
- Smooth chip flow by small dots in external machining
- Available for both external machining and grooving

MGMN - G



- Specially designed chip breaker allows narrower chips to promote better chip flow with the use of center dots
- Exclusive chip breaker for grooving

Insert code system (KGT)

KG	M	N	300	04	T
System code KGT system (KORLOY Grooving)	Tolerance M: Pressed class G: Ground class	Hand N: Neutral R: Right L: Light I: Internal	Width of cutting edge 2.0~8.0 mm	Corner nose radius of insert 0.2 mm 0.3 mm 0.4 mm	Chip breaker C/L/R/T LP/RP

Insert code system (MGT)

MG	M	N	300	04	T
System code MGT system (Multi Grooving)	Tolerance M: Pressed class G: Ground class	Hand N: Neutral R: Right L: Light I: Internal	Width of cutting edge 2.0~8.0 mm	Corner nose radius of insert 0.2 mm 0.3 mm 0.4 mm	Chip breaker M/G L/R/T

Holder code system (KGT/MGT)

KG	E	H	R	1212	3	D25A
System code KGT MGT	Application E: External machining I: Internal machining	Holder type H: Horizontal type V: Vertical type U: Undercut type	Hand R: Right L: Light	Shank size Height 12 mm, width 12 mm (For internal machining: Min. machining diameter)	Cutting width 2.0~3.0 mm	Max. cutting diameter Ø15~32 mm A: Compact type B: high rigidity type

● C/B guide

L For Light Grooving

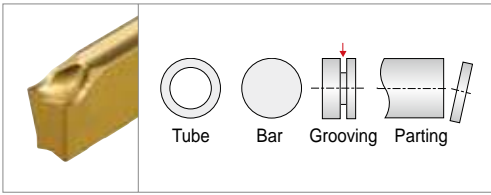

- Sharp cutting edge
- Low feed machining
- Small diameter component
- Low carbon steel
- Alloy steel
- Stainless

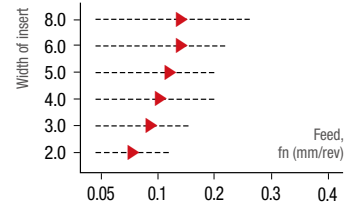

R For Rough Grooving

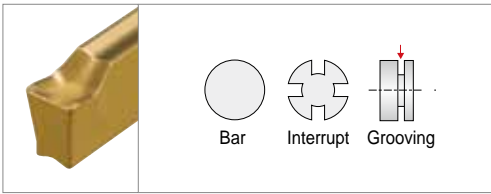

- Strong cutting edge
- High feed machining
- Interrupted cutting
- Carbon steel
- Alloy steel
- Stainless
- Cast iron

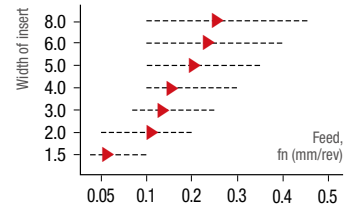

T For Turning and Multi Grooving

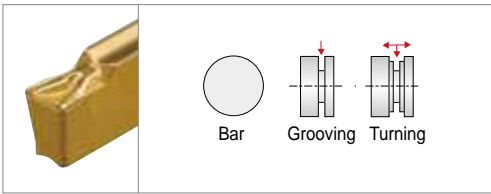

- Sharp cutting edge
- Improved chip control
- Turning & grooving machining
- Carbon steel
- Alloy steel
- Stainless
- Cast iron

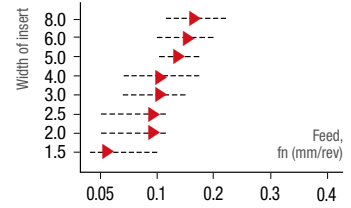

C For Copying and Relief

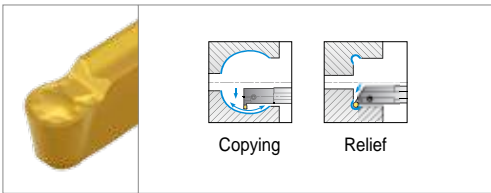

- Improved chip control
- Copying
- Relief
- Carbon steel
- Alloy steel
- Stainless
- Cast iron

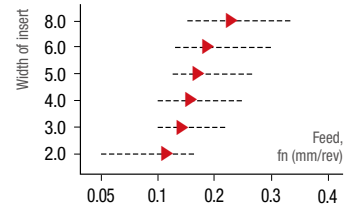

LP For Light Parting

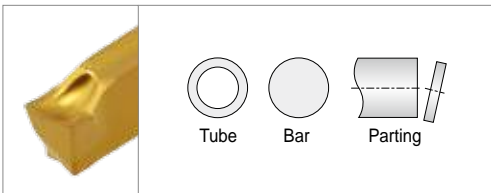

- Sharp cutting edge
- Low feed machining
- Small diameter component
- Right/Left handed
- Low carbon steel
- Carbon steel
- Alloy steel
- Stainless

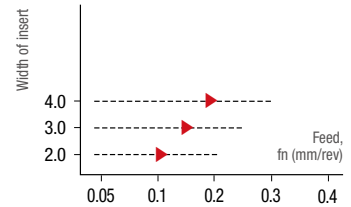

RP For Rough Parting

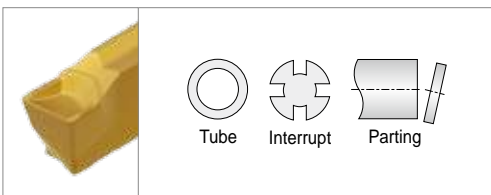

- Strong cutting edge
- High feed machining
- Interrupted cutting
- Right/Left handed
- Carbon steel
- Alloy steel
- Cast iron

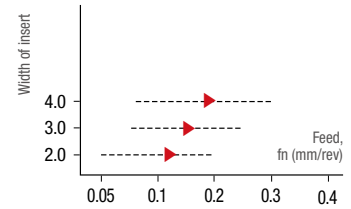









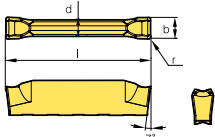

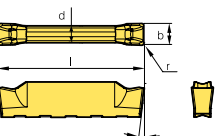

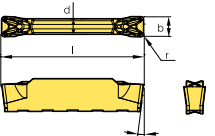

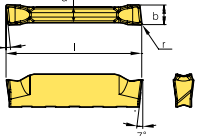

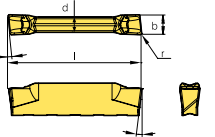
Grades and recommended cutting conditions

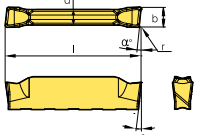
Workpiece	Grade	Order of recommended grade	Recommended cutting speed, vc (m/min)				
			50	100	150	200	
P	Carbon steel	PC3035	1		80	220	
		PC5300	2		80	200	
		NC3225	3			130	220
		NC5330	4			120	200
	Alloy steel	PC3035	1		80	180	
		PC5300	2		80	160	
		NC3225	3			130	200
		NC5330	4		90	180	
M	Stainless steel	PC5300	1		70	120	
		PC9030	2		70	115	
		NC5330	3		75	125	
K	Cast iron	PC5300	1	55	90		
		NC5330	2		95	160	
S	HRSA	PC5300	1	20	35		

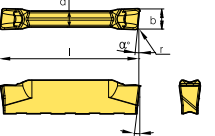
● Applicable inserts (KGT)

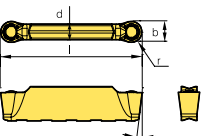
Insert													
Type	C/B	Designation	Coated					Dimensions (mm)					Configuration
	Picture		NC3225	NC5330	PC3035	PC5300	PC9030	b	r	ℓ	d	α°	
Grooving		KGML 200-02-L 300-02-L	● ● ● ● ●	● ● ● ● ●	● ● ● ● ●	● ● ● ● ●	2	0.2	20	1.7	-		
			● ● ● ● ●	● ● ● ● ●	● ● ● ● ●	● ● ● ● ●	3	0.2	20	2.3	-		
Grooving Parting off		KGML 200-02-R 300-02-R	● ● ● ● ●	● ● ● ● ●	● ● ● ● ●	● ● ● ● ●	2	0.2	20	1.7	-		
			● ● ● ● ●	● ● ● ● ●	● ● ● ● ●	● ● ● ● ●	3	0.2	20	2.3	-		
Grooving turning		KGML 200-02-T 300-02-T 300-04-T	● ● ● ● ●	● ● ● ● ●	● ● ● ● ●	● ● ● ● ●	2	0.2	20	1.7	-		
			● ● ● ● ●	● ● ● ● ●	● ● ● ● ●	● ● ● ● ●	3	0.2	20	2.3	-		
			● ● ● ● ●	● ● ● ● ●	● ● ● ● ●	● ● ● ● ●	3	0.4	20	2.3	-		
Parting off (Right handed)		KGMR 200-6D-LP 200-15D-LP 300-6D-LP 300-15D-LP	● ● ● ● ●	● ● ● ● ●	● ● ● ● ●	● ● ● ● ●	2	0.2	20	1.7	6		
			● ● ● ● ●	● ● ● ● ●	● ● ● ● ●	● ● ● ● ●	2	0.2	20	1.7	15		
			● ● ● ● ●	● ● ● ● ●	● ● ● ● ●	● ● ● ● ●	3	0.2	20	2.3	6		
			● ● ● ● ●	● ● ● ● ●	● ● ● ● ●	● ● ● ● ●	3	0.2	20	2.3	15		
Parting off (Right handed)		KGMR 200-6D-RP 200-15D-RP 300-6D-RP 300-15D-RP	● ● ● ● ●	● ● ● ● ●	● ● ● ● ●	● ● ● ● ●	2	0.2	20	1.7	6		
			● ● ● ● ●	● ● ● ● ●	● ● ● ● ●	● ● ● ● ●	2	0.2	20	1.7	15		
			● ● ● ● ●	● ● ● ● ●	● ● ● ● ●	● ● ● ● ●	3	0.2	20	2.3	6		
			● ● ● ● ●	● ● ● ● ●	● ● ● ● ●	● ● ● ● ●	3	0.2	20	2.3	15		
Parting off (Left handed)		KGML 200-6D-LP 200-15D-LP 300-6D-LP 300-15D-LP	● ● ● ● ●	● ● ● ● ●	● ● ● ● ●	● ● ● ● ●	2	0.2	20	1.7	6		
			● ● ● ● ●	● ● ● ● ●	● ● ● ● ●	● ● ● ● ●	2	0.2	20	1.7	15		
			● ● ● ● ●	● ● ● ● ●	● ● ● ● ●	● ● ● ● ●	3	0.2	20	2.3	6		
			● ● ● ● ●	● ● ● ● ●	● ● ● ● ●	● ● ● ● ●	3	0.2	20	2.3	15		
Parting off (Left handed)		KGML 200-6D-RP 200-15D-RP 300-6D-RP 300-15D-RP	● ● ● ● ●	● ● ● ● ●	● ● ● ● ●	● ● ● ● ●	2	0.2	20	1.7	6		
			● ● ● ● ●	● ● ● ● ●	● ● ● ● ●	● ● ● ● ●	2	0.2	20	1.7	15		
			● ● ● ● ●	● ● ● ● ●	● ● ● ● ●	● ● ● ● ●	3	0.2	20	2.3	6		
			● ● ● ● ●	● ● ● ● ●	● ● ● ● ●	● ● ● ● ●	3	0.2	20	2.3	15		
Grooving Turning		KRMN 200-C 300-C	● ● ● ● ●	● ● ● ● ●	● ● ● ● ●	● ● ● ● ●	2	1.0	20	1.7	-		
			● ● ● ● ●	● ● ● ● ●	● ● ● ● ●	● ● ● ● ●	3	1.5	20	2.2	-		

●: Stock item



Available tool holders (KGT)

Holders

KGEHR/L-D00A (Compact type)



KGGN KGMN KGMR/L
KRGN KRMN

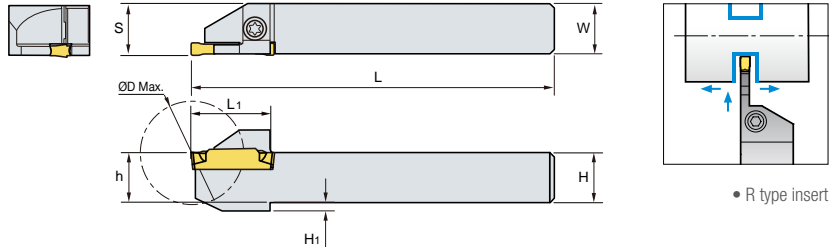

Designation		Stock		Dimensions (mm)							Insert	Screw	Wrench
		R	L	H=h	W	L ₁	L	S	H ₁	ØD			
KGEHR/L	1010-2-D20A	●	●	10	10	19	125	10.2	2	20	KGMN200-□-□ KGMR/L200-□-□ KRMN200-C	ETNA0412	TW15L
	1212-2-D25A	●	●	12	12	19	125	12.2	2	25			
	1414-2-D25A	●	●	14	14	19	125	14.2	-	25			
	1616-2-D32A	●	●	16	16	24	125	16.2	-	32	KGMN300-□-□ KGMR/L300-□-□ KRMN300-C		
	1212-3-D25A	●	●	12	12	19	130	12.4	2	25			
	1616-3-D32A	●	●	16	16	24	130	16.4	-	32			

●: Stock item

KGEHR/L-D00B (High rigidity type)



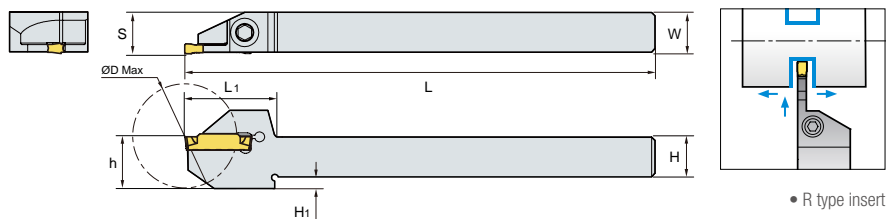

KGGN KGMN KGMR/L
KRGN KRMN



Designation		Stock		Dimensions (mm)							Insert	Screw	Wrench
		R	L	H=h	W	L ₁	L	S	H ₁	ØD			
KGEHR/L	1010-2-D30B	●	●	10	10	29.6	140	10.2	6.6	30	KGMN200-□-□ KGMR/L200-□-□ KRMN200-C	MHA0512	HW40L
	1212-2-D25B	●	●	12	12	27.1	140	12.2	3.5	25			
	1212-2-D30B	●	●	12	12	29.6	140	12.2	3.5	30			
	1616-2-D32B	●	●	16	16	30.6	140	16.2	-	32	KGMN300-□-□ KGMR/L300-□-□ KRMN300-C		
	1212-3-D25B	●	●	12	12	27.1	140	12.4	3.5	25			
	1212-3-D32B	●	●	12	12	30.6	140	12.4	3.5	32			
	1616-3-D32B	●	●	16	16	30.6	140	16.4	-	32			

●: Stock item

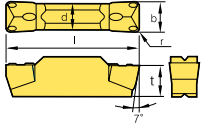
● Applicable inserts (MGT)

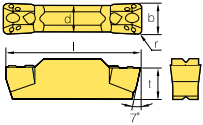
Insert													
Type	C/B	Designation	Coated				Dimensions (mm)					Configuration	
	Picture		NC3225	NC3030	PC5300	PC9030	b	r	l	d	t		
Grooving		MGMN	150-G	●	●	●	●	1.5	0.15	16.0	1.2	3.50	
			200-G	●	●	●	●	2.0	0.20	16.0	1.6	3.50	
			250-G	●	●	●	●	2.5	0.20	18.5	2.0	3.85	
Grooving turning		MGMN	200-M	●	●	●	●	2.0	0.20	16.0	1.6	3.50	
			250-M	●	●	●	●	2.5	0.20	18.5	2.0	3.85	

●: Stock item

● Available tool holders (MGT)

Holders

MGEHR/L



MGGN MGNM

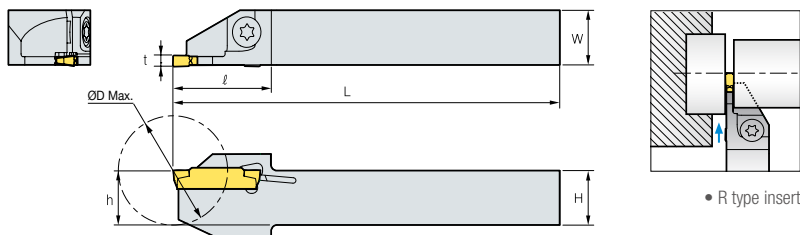

● R type insert

Designation	Stock		Dimensions (mm)							Insert	Screw	Wrench
	R	L	H=h	W	L	l	t	ØD				
MGEHR/L	1010-X15A	●		10	10	125	18.0	1.5	20	MGMN150-G	ETNA0412	TW15L
	1212-X15A	●		12	12	125	19.5	1.5	25			
	1010-X20A	●		10	10	125	18.0	2.0	20	MGMN200-M MGMN200-G	ETNA0412	TW15L
	1212-X20A	●		12	12	125	19.5	2.0	25			
1616-X20A			16	16	125	25.0	2.0	32	MGMN250-M MGMN250-G	ETNA0412	TW15L	
1010-X25A	●		10	10	125	20.0	2.5	20				
1212-X25A	●		12	12	125	20.0	2.5	25				
1616-X25A			16	16	125	25.0	2.5	32				

●: Stock item



MSB Tools

Features

- High hardness grade guarantees longer tool life
- Various kinds of machining (Fitting, Valve, Medical parts, Automobile component, and Semiconductor equipment) are available
- Various types of MSB tools (Boring, Grooving, Threading)

Grades

Grades	Coating	Application and features
Z12M	Carbide	<ul style="list-style-type: none"> • Ultra fine grain substrate ensures superior wear resistance and toughness • Application: Cast iron, Aluminum alloy and non-ferrous metals machining
PC30M	TiN coating	<ul style="list-style-type: none"> • TiN coated ultra fine grain substrate ensures long tool life • Application: Stainless steel, heat resisting alloy and hard-to-cut material machining

Types

Boring

- Boring**
Min. dia. of machining: Ø3.2
- Copying**
Min. dia. of machining: Ø4.2
- Back boring**
Min. dia. of machining: Ø3.2
- Chamfering**
Min. dia. of machining: Ø4.2

Grooving

- Square grooving**
Min. dia. of machining: Ø3.2
- Round grooving**
Min. dia. of machining: Ø3.2
- Face grooving**
Min. dia. of machining: Ø6.0

Threading

- Threading**
Min. dia. of machining: Ø3.3



● Machining types



● Code system

M	G	R	06	06	$\frac{1.5}{\diamond 60}$	-	1																					
Type M: Micro	Application B: Boring BC: Copying BB: Back boring BF: Chamfering G: Square grooving GR: Round grooving GF: Face grooving T: Threading	Hand R: Right L: Left	Shank dia. 03: 3.0 04: 4.0 06: 6.0 08: 8.0 10: 10.0	Max. aspect ratio 10: 10.0 15: 15.0 20: 20.0 25: 25.0 30: 30.0	Machining size	Cutting edge 1: Single ended None: Double ended																						
					<table border="1"> <tr> <td>Boring</td> <td colspan="2">No code</td> </tr> <tr> <td>Copying</td> <td colspan="2">Width of groove</td> </tr> <tr> <td rowspan="2">Threading</td> <td>60°</td> <td>55°</td> </tr> <tr> <td>Pitch</td> <td>tpi</td> </tr> <tr> <td rowspan="3">◇</td> <td>F</td> <td>0.25~1.0</td> <td>72~24</td> </tr> <tr> <td>A</td> <td>0.5~1.5</td> <td>48~16</td> </tr> <tr> <td>AG</td> <td>0.5~3.0</td> <td>48~8</td> </tr> </table>	Boring	No code		Copying	Width of groove		Threading	60°	55°	Pitch	tpi	◇	F	0.25~1.0	72~24	A	0.5~1.5	48~16	AG	0.5~3.0	48~8		
Boring	No code																											
Copying	Width of groove																											
Threading	60°	55°																										
	Pitch	tpi																										
◇	F	0.25~1.0	72~24																									
	A	0.5~1.5	48~16																									
	AG	0.5~3.0	48~8																									

● MSB tool code system

Types		Application	Designation	
01	Boring	Boring	MBR/LA○○○○☆☆☆	
02		Copying	MBCR/LA○○○○☆☆☆	
03		Back boring	MBBR/LA○○○○☆☆☆	
04		Chamfering	MBFR/LA○○○○☆☆☆	
05	Grooving	Square grooving	MGR/LA○○○○☆☆☆-□□	
06		Round grooving	MGRR/LA○○○○☆☆☆-□□	
07		Face grooving	MGFR/LA○○○○☆☆☆-□□	
08	Threading	Partial	60°	MTR/LA○○○○☆☆☆-◇60
			55°	MTR/LA○○○○☆☆☆-◇55
Marks	○○○○	Shank dia.		
	☆☆☆	Max. depth of boring		
	□□	Width of groove		
	◇	Pitch/tpi	F	0.25~1.0
		A	0.5~1.5	48~16
		AG	0.5~3.0	48~8



Recommended cutting conditions

※ For using PC30M

Workpiece		Recommended cutting speed, vc (m/min)										
		30	60	90	120	150	180	210	240	270	300	330
P	Steel			90				190				
M	Stainless steel		30	90								
K	Cast iron		40	70								
N	Non-ferrous metal			80							300	
S	Heat resistant alloy, Titanium alloy	10	40									
H	Hardened steel		25	45								

● Applicable MSB tools

MSB tools

Boring (MBR)

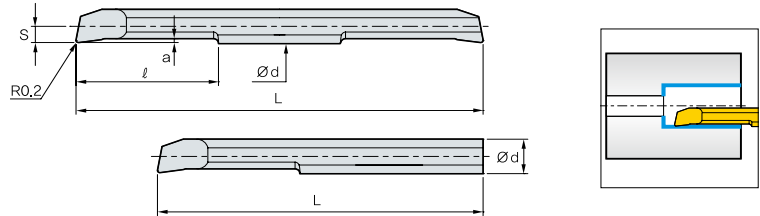

(mm)

Twin edge			Single edge			Ød	Min.dia. of machining	ℓ	Overall length		Detailed cutting edge	
Designation	Coated	Uncoated	Designation	Coated	Uncoated				L		a	S
	PC30M	Z12M		PC30M	Z12M				Double ended	Single ended		
MBR	0310	●	MBR	0310-1		3.0	3.2	10	40	35	0.5	1.4
	0315	●		0315-1				15	50	45		
	0410	●		0410-1				10	40	35		
	0415	●		0415-1		4.0	4.2	15	50	45	0.6	1.9
	0420	●		0420-1				20	60	50		
	0610	●		0610-1				10	45	40		
	0615	●		0615-1		6.0	6.2	15	55	45	0.75	2.9
	0620	●		0620-1				20	65	50		
	0810	●		0810-1				10	50	45		
	0820	●		0820-1		8.0	8.2	20	70	60	0.8	3.9
	0830	●		0830-1				30	80	70		
	1015	●		1015-1				15	60	60		
	1025	●		1025-1		10.0	10.2	25	80	70	1.0	4.9
	1035	●		1035-1				35	100	80		

●: Stock item

Boring (MBCR)

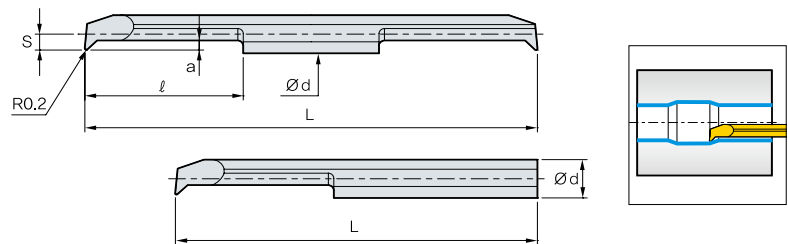

(mm)

Twin edge			Single edge			Ød	Min.dia. of machining	ℓ	Overall length		Detailed cutting edge	
Designation	Coated	Uncoated	Designation	Coated	Uncoated				L		a	S
	PC30M	Z12M		PC30M	Z12M				Double ended	Single ended		
MBCR	0410	●	MBCR	0410-1		4.0	4.2	10	40	35	1.0	1.9
	0415	●		0415-1				15	50	45		
	0420	●		0420-1				20	60	50		
	0610	●		0610-1		6.0	6.2	10	45	40	1.3	2.9
	0615	●		0615-1				15	55	45		
	0620	●		0620-1				20	60	50		

●: Stock item



MSB tools

Back boring (MBBR)

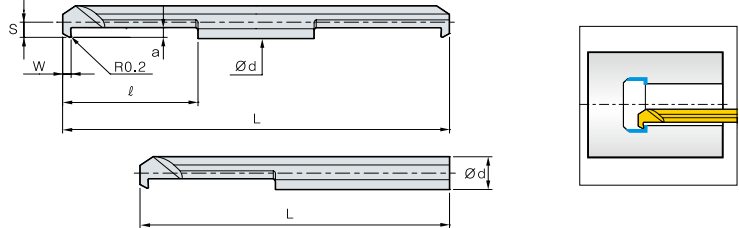

(mm)

Twin edge			Single edge			Ød	Min.dia. of machining	ℓ	Overall length		Detailed cutting edge			
Designation	Coated	Uncoated	Designation	Coated	Uncoated				L		W	a	S	
	PC30M	Z12M		PC30M	Z12M				Double ended	Single ended				
MBBR 0310	●		MBBR 0310-1			3.0	3.2	10	40	35	1.5	0.8	1.4	
	●			0315-1					15	50				45
	●			0410-1					10	40				35
0415	●		0415-1			4.0	4.2	15	50	45	2.0	1.3	1.9	
0420	●		0420-1					20	60	50				
0610	●		0610-1			6.0	6.2	10	45	40	2.0	1.9	2.9	
0615	●		0615-1					15	55	45				
0620	●		0620-1					20	65	50				

●: Stock item

Chamfering (MBFR)

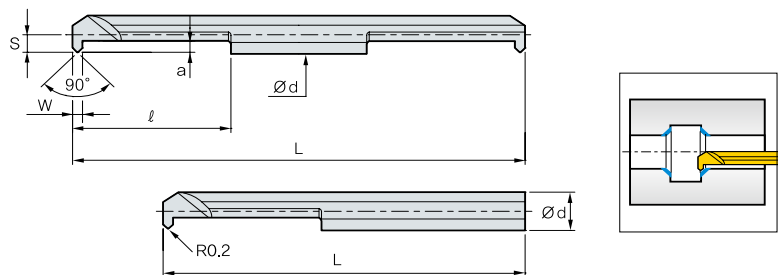

(mm)

Twin edge			Single edge			Ød	Min.dia. of machining	ℓ	Overall length		Detailed cutting edge			
Designation	Coated	Uncoated	Designation	Coated	Uncoated				L		W	a	S	
	PC30M	Z12M		PC30M	Z12M				Double ended	Single ended				
MBFR 0410	●		MBFR 0410-1			4.0	4.2	10	40	35	0.8	1.0	1.9	
	●			0415-1					15	50				45
	●			0420-1					20	60				50
0610	●		0610-1			6.0	6.2	10	45	40	1.4	1.2	2.9	
0615	●		0615-1					15	55	45				
0620	●		0620-1			20	60	50						

●: Stock item

MSB tools

Square grooving (MGR)

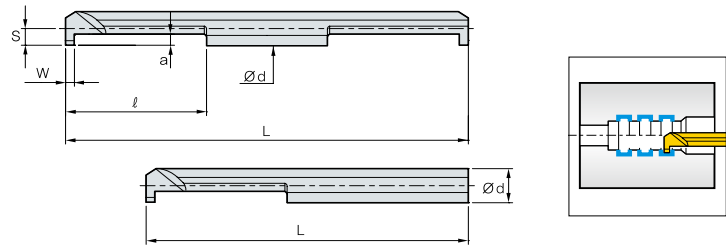

(mm)

Twin edge			Single edge			Ød	Min.dia. of machining	l	Overall length		Detailed cutting edge			
Designation	Coated	Uncoated	Designation	Coated	Uncoated				L		W	a	S	
	PC30M	Z12M		PC30M	Z12M				Double ended	Single ended				
MGR	0310-1.0	●	MGR	0310-1.0-1		3.0	3.2	10	40	35	1.0	0.8	1.4	
	0315-1.0	●		0315-1.0-1				15	50	45				
	0310-1.5	●		0310-1.5-1				10	40	35	1.5			
	0315-1.5	●		0315-1.5-1				15	50	45				
	0410-1.0	●		0410-1.0-1		4.0	4.2	10	40	35	1.0	1.4	1.9	
	0420-1.0			0420-1.0-1				20	60	50				
	0410-1.5			0410-1.5-1				10	40	35	1.5			
	0420-1.5			0420-2.0-1				20	60	50				
	0410-2.0	●		0410-2.0-1		10	40	35	2.0					
	0420-2.0			0420-2.0-1		20	60	50						
	0610-1.0	●		0610-1.0-1		6.0	6.2	10	45	40	1.0	1.8	2.9	
	0620-1.0	●		0620-1.0-1				20	65	50				
	0610-1.5	●		0610-1.5-1				10	45	40	1.5			
	0620-1.5	●		0620-1.5-1				20	65	50				
	0610-2.0	●		0610-2.0-1				10	45	40	2.0			
	0620-2.0	●		0620-2.0-1				20	65	50				
	0610-2.5	●		0610-2.5-1				10	45	40	2.5			
	0620-2.5	●		0620-2.5-1				20	65	50				
	0820-1.5	●		0820-1.5-1		8.0	8.2	20	70	60	1.5	0.8	1.3	3.9
	0820-2.0	●		0820-2.0-1							2.0			
0820-2.5	●	0820-2.5-1		2.5										
0820-3.0	●	0820-3.0-1		3.0										
1025-1.5	●	1025-1.5-1		10.0	10.2	25	80	70	1.5	0.8	1.3	4.9		
1025-2.0	●	1025-2.0-1							2.0					
1025-2.5	●	1025-2.5-1							2.5					
1025-3.0	●	1025-3.0-1							3.0					

●: Stock item



MSB tools

Round grooving (MGRR)

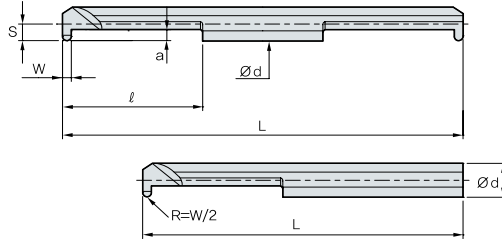

(mm)

Twin edge			Single edge			Ød	Min.dia. of machining	l	Overall length		Detailed cutting edge		
Designation	Coated	Uncoated	Designation	Coated	Uncoated				L		W	a	S
	PC30M	Z12M		PC30M	Z12M				Double ended	Single ended			
MGRR	0310-0.8	●	MGRR	0310-0.8-1		3.0	3.2	10	40	35	0.8	0.8	1.4
	0315-0.8	●		0315-0.8-1					15	50			
	0410-1.0	●		0410-1.0-1		4.0	4.2	10	40	35	1.0	1.0	1.9
	0420-1.0	●		0420-1.0-1					20	60			
	0610-1.0	●		0610-1.0-1		6.0	6.2	10	45	40	1.0	2.0	2.9
	0620-1.0	●		0620-1.0-1					20	65			
	0610-1.5	●		0610-1.5-1					10	45	40		
	0620-1.5	●		0620-1.5-1					20	65	50		
	0610-2.0	●		0610-2.0-1					10	45	40		
	0620-2.0	●		0620-2.0-1					20	65	50		
	0820-1.0	●		0820-1.0-1		8.0	8.2	20	70	60	1.0	2.3	3.9
	0820-1.5	●		0820-1.5-1							1.5		
	0820-2.0			0820-2.0-1							2.0		
	1025-1.0	●		1025-1.0-1		10.0	10.2	25	80	70	1.0	2.8	4.9
	1025-1.5	●		1025-1.5-1							1.5		
	1025-2.0	●		1025-2.0-1							2.0		

●: Stock item

MSB tools

Face grooving (MGFR)

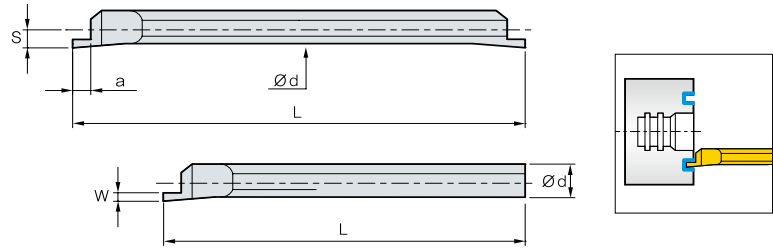
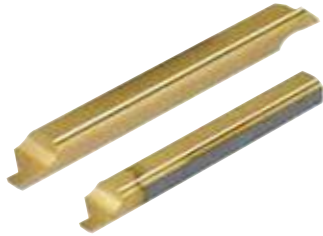

(mm)

Twin edge			Single edge			Ød	Min.dia. of machining	Overall length		Detailed cutting edge		
Designation	Coated	Uncoated	Designation	Coated	Uncoated			L		W	a	S
	PC30M	Z12M		PC30M	Z12M			Double ended	Single ended			
MGFR	0400-1.0	●	MGFR	0400-1.0-1		4.0	6.0	50	45	1.0	1.5	1.8
	0400-1.5	●		0400-1.5-1						1.5	2.0	
	0600-1.0	●		0600-1.0-1		6.0	8.5	50	45	1.0	1.5	2.9
	0600-1.5	●		0600-1.5-1						1.5	2.0	
	0600-2.0	●		0600-2.0-1		8.0	10.4	70	60	2.0	2.5	3.9
	0800-1.0	●		0800-1.0-1						1.0	1.5	
	0800-1.5	●		0800-1.5-1						1.5	2.0	
	0800-2.0	●		0800-2.0-1		10.0	12.4	80	70	2.0	2.5	4.9
	0800-2.5	●		0800-2.5-1						2.5	3.0	
	0800-3.0	●		0800-3.0-1						3.0	3.5	
1000-2.0	●		1000-2.0-1						2.0	2.5		
1000-2.5	●		1000-2.5-1						2.5	3.0		
1000-3.0	●		1000-3.0-1						3.0	3.5		
1000-3.5	●		1000-3.5-1						3.5	4.0		
1000-4.0	●		1000-4.0-1						4.0	4.5		
1000-4.5	●		1000-4.5-1		4.5	5.0						

●: Stock item

Threading (MTR)

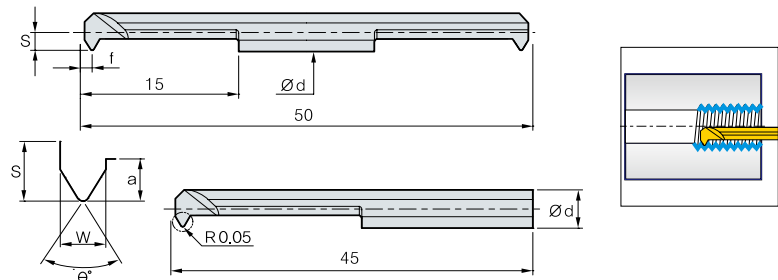

(mm)

Twin edge			Single edge			Ød	Min.dia. of machining	Threading			Detailed cutting edge		
Designation	Coated	Uncoated	Designation	Coated	Uncoated			W	Pitch (mm/tpi)	θ°	S	a	f
	PC30M	Z12M		PC30M	Z12M								
MTR	0315-F60	●	MTR	0315-F60-1		3.0	3.3	1.2	0.5~1.0 (mm)	60°	1.45	1.2	0.6
	0415-F60	●		0415-F60-1							1.95		
	0615-A60	●		0615-A60-1		6.0	6.2	2.0	0.5~1.5 (mm)	55°	2.90	2.2	1.0
	0315-F55	●		0315-F55-1							3.0		
	0415-F55	●		0415-F55-1		1.95							
	0615-A55	●		0615-A55-1		6.0	6.2	2.0	28~16 (tpi)	2.90		2.2	1.0

●: Stock item



○ **Applicable sleeve**

Sleeve

Sleeve (SL)

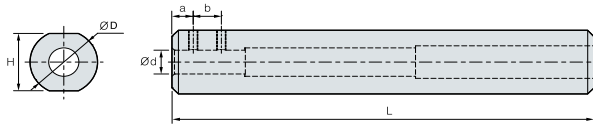

Fig.1

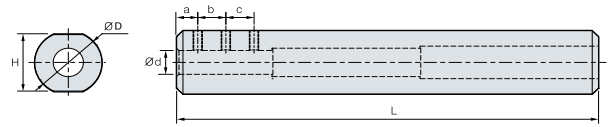



Fig.2

(mm)

Designation	Stock	Dimensions (mm)							Screw 	Wrench 	Fig.
		Ød	a	B	c	ØD	H	L			
SL 1603	●	3	5	-	-	16	14	100	M3	HW15L	1
1604	●	4	5	6	-	16	14	100	M4	HW20L	
1605	●	5	5	8	-	16	14	100	M4	HW20L	
1606	●	6	5	6	6	16	14	100	M4	HW20L	2
1607	●	7	5	6	8	16	14	100	M4	HW20L	
2008	●	8	5	10	10	20	18	100	M4	HW20L	
2010	●	10	5	10	10	20	18	100	M5	HW20L	

●: Stock item

Fine Tools

(NFTG)

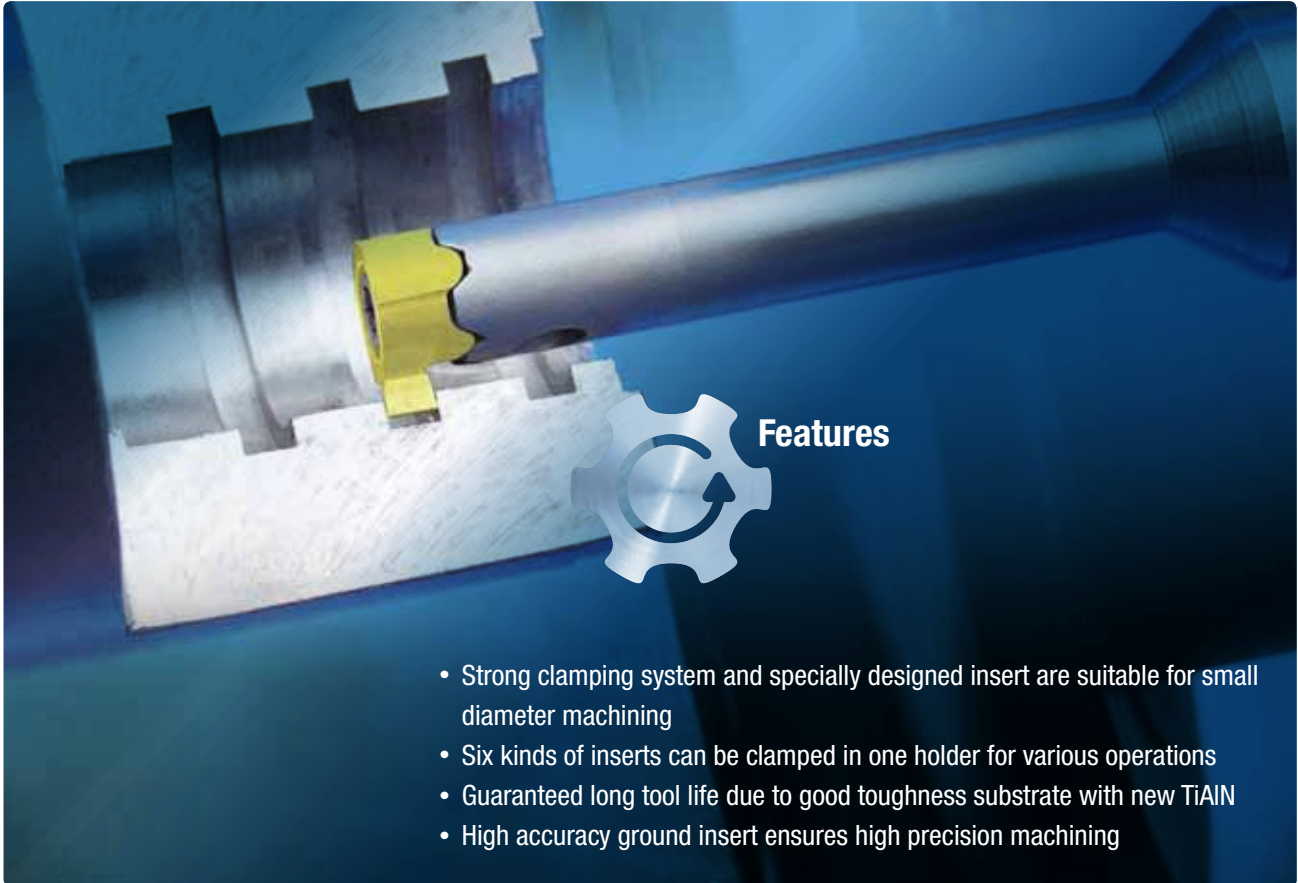

Features

- Strong clamping system and specially designed insert are suitable for small diameter machining
- Six kinds of inserts can be clamped in one holder for various operations
- Guaranteed long tool life due to good toughness substrate with new TiAlN
- High accuracy ground insert ensures high precision machining

Application range

- Internal grooving, Profiling, Threading and boring at $\varnothing 8$ mm~ $\varnothing 16$ mm

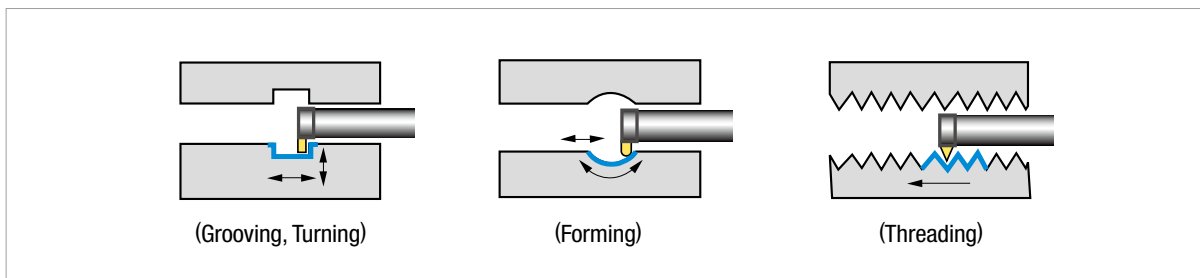



















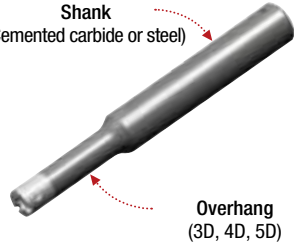

Code system

NFTIH	08	3	12	-	S
	Minimum diameter	Overhang (l/ØD)	Shank dia.		Shank type S: Steel, C: Carbide



Clamping system

Screw	Insert	Holder	Available R/L type insert with one holder								
	<table border="1"> <thead> <tr> <th>R type</th> <th>L type</th> </tr> </thead> <tbody> <tr> <td></td> <td></td> </tr> <tr> <td></td> <td></td> </tr> <tr> <td></td> <td></td> </tr> </tbody> </table>	R type	L type							 <p>Shank (Cemented carbide or steel)</p> <p>Overhang (3D, 4D, 5D)</p>	
R type	L type										
											
											
											

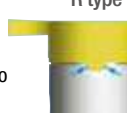
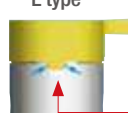
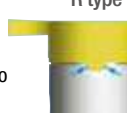
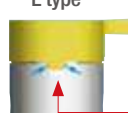
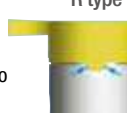
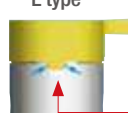
	Stable clamping according to the tripod structure	<table border="1"> <thead> <tr> <th>R type</th> <th>L type</th> </tr> </thead> <tbody> <tr> <td></td> <td></td> </tr> </tbody> </table>	R type	L type			No-Spin-System design for strong clamping
R type	L type						
							

Recommended cutting conditions

Workpiece		Recommended cutting speed				
		Min. machining dia. (ØDmin)				
		Ø8	Ø11	Ø14	Ø16	
P	Carbon steel	Cutting speed, vc (m/min)	70~120	70~120	70~120	70~120
		Feed, fn (mm/rev)	0.01~0.04	0.01~0.05	0.02~0.05	0.02~0.06
	Alloy steel	Cutting speed, vc (m/min)	70~120	70~120	70~120	70~120
		Feed, fn (mm/rev)	0.01~0.02	0.01~0.04	0.02~0.04	0.02~0.05
K	Cast iron	Cutting speed, vc (m/min)	60~100	60~100	60~100	60~100
		Feed, fn (mm/rev)	0.01~0.05	0.01~0.05	0.02~0.05	0.02~0.05
N	Non-ferrous alloy	Cutting speed, vc (m/min)	100~180	100~180	100~180	100~180
		Feed, fn (mm/rev)	0.02~0.06	0.02~0.06	0.02~0.06	0.02~0.06

※ In case of chattering, reduce the cutting speed and feed

※ To find the optimal cutting conditions, advise to gradually increase from the lowest cutting condition of the above recommendation

※ In case of the unilateral grooving depth over 1 mm, work to the step feed rate

● Applicable inserts

Insert

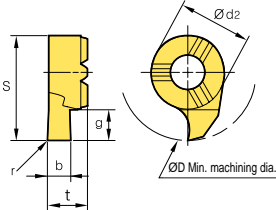
Type	Picture	Designation	Coated		Dimensions (mm)									Configuration
			PC5300		ØD	b	r	S	g	Ød ₂	t	Pitch	f	
			R	L										
Grooving		NFTG 08075R/L	●		8	0.75	-	7.75	1.3	5.9	3.85	-	-	
		08085R/L	●		8	0.85	-	7.75	1.3	5.9	3.85	-	-	
		08095R/L	●		8	0.95	-	7.75	1.3	5.9	3.85	-	-	
		08121R/L	●		8	1.21	-	7.75	1.3	5.9	3.85	-	-	
		08141R/L	●		8	1.41	-	7.75	1.3	5.9	3.85	-	-	
		08152R/L	●		8	1.52	-	7.75	1.3	5.9	3.85	-	-	
		08171R/L	●		8	1.71	-	7.75	1.3	5.9	3.85	-	-	
		08202R/L	●		8	2.02	-	7.75	1.3	5.9	3.85	-	-	
		11075R/L	●		11	0.75	-	10.7	1.8	8.0	4.90	-	-	
		11085R/L	●		11	0.85	-	10.7	1.8	8.0	4.90	-	-	
		11095R/L	●		11	0.95	-	10.7	1.8	8.0	4.90	-	-	
		11121R/L	●		11	1.21	-	10.7	2.6	8.0	4.90	-	-	
		11141R/L	●		11	1.41	-	10.7	2.6	8.0	4.90	-	-	
		11152 R/L	●		11	1.52	-	10.7	2.6	8.0	4.90	-	-	
		11171R/L	●		11	1.71	-	10.7	2.6	8.0	4.90	-	-	
		11202R/L	●		11	2.02	-	10.7	2.6	8.0	4.90	-	-	
		11202R/L-02	●		11	2.02	0.2	10.7	2.6	8.0	4.90	-	-	
		11252R/L	●		11	2.52	-	10.7	2.6	8.0	4.90	-	-	
		11302R/L	●		11	3.02	-	10.7	2.6	8.0	4.90	-	-	
		14075R/L	●		14	0.75	-	13.5	1.8	9.0	5.85	-	-	
		14085R/L	●		14	0.85	-	13.5	1.8	9.0	5.85	-	-	
		14095R/L	●		14	0.95	-	13.5	1.8	9.0	5.85	-	-	
		14121R/L	●		14	1.21	-	13.5	4.3	9.0	5.85	-	-	
		14141R/L	●		14	1.41	-	13.5	4.3	9.0	5.85	-	-	
		14152R/L	●		14	1.52	-	13.5	4.3	9.0	5.85	-	-	
		14171R/L	●		14	1.71	-	13.5	4.3	9.0	5.85	-	-	
		14202R/L	●		14	2.02	-	13.5	4.3	9.0	5.85	-	-	
		14252R/L	●		14	2.52	-	13.5	4.3	9.0	5.85	-	-	
		14302R/L	●		14	3.02	-	13.5	4.3	9.0	5.85	-	-	
		16075R/L	●		16	0.75	-	15.7	1.8	11.0	5.80	-	-	
		16085R/L	●		16	0.85	-	15.7	1.8	11.0	5.80	-	-	
		16095R/L	●		16	0.95	-	15.7	1.8	11.0	5.80	-	-	
		16121R/L	●		16	1.21	-	15.7	4.6	11.0	5.80	-	-	
		16141R/L	●		16	1.41	-	15.7	4.6	11.0	5.80	-	-	
		16171R/L	●		16	1.71	-	15.7	4.6	11.0	5.80	-	-	
		16202R/L	●		16	2.02	-	15.7	4.6	11.0	5.80	-	-	
		16252R/L	●		16	2.52	-	15.7	4.6	11.0	5.80	-	-	
		16302R/L	●		16	3.02	-	15.7	4.6	11.0	5.80	-	-	
		16352R/L	●		16	3.52	-	15.7	4.6	11.0	5.80	-	-	
		16402R/L	●		16	4.02	-	15.7	4.6	11.0	5.80	-	-	

●: Stock item



Insert

Type	Picture	Designation	Coated		Dimensions (mm)									Configuration	
			PC5300		ØD	b	r	S	g	Ød ₂	t	Pitch	f		
			R	L											
Threading		NFTT	0805MR/L	●		8	-	-	7.75	-	6	3.85	0.5	1.0	
			0810MR/L	●		8	-	-	7.75	-	6	3.85	1.0	1.0	
			0815MR/L	●		8	-	-	7.75	-	6	3.85	1.5	1.2	
			1110MR/L	●		11	-	-	10.7	-	8	4.90	1.0	1.2	
			1115MR/L	●		11	-	-	10.7	-	8	4.90	1.5	1.2	
			1120MR/L	●		11	-	-	10.7	-	8	4.90	2.0	1.2	
			1125MR/L	●		11	-	-	10.7	-	8	4.90	2.5	1.2	
			1410MR/L	●		14	-	-	13.5	-	9	5.85	1.0	1.2	
			1415MR/L	●		14	-	-	13.5	-	9	5.85	1.5	1.2	
			1420MR/L	●		14	-	-	13.5	-	9	5.85	2.0	1.2	
			1425MR/L	●		14	-	-	13.5	-	9	5.85	2.5	1.2	
			1610MR/L	●		16	-	-	15.7	-	11	5.80	1.0	1.2	
			1615MR/L	●		16	-	-	15.7	-	11	5.80	1.5	1.2	
			1620MR/L	●		16	-	-	15.7	-	11	5.80	2.0	1.2	
			1625MR/L	●		16	-	-	15.7	-	11	5.80	2.5	1.2	
			1630MR/L	●		16	-	-	15.7	-	11	5.80	3.0	1.5	
			1635MR/L	●		16	-	-	15.7	-	11	5.80	3.5	1.6	
1640MR/L	●		16	-	-	15.7	-	11	5.80	4.0	1.8				
Profiling		NFTT	08082R/L	●		8	0.82	0.41	7.75	1.3	5.9	3.85	-	-	
			08122R/L	●		8	1.22	0.61	7.75	1.3	5.9	3.85	-	-	
			08182R/L	●		8	1.82	0.91	7.75	1.3	5.9	3.85	-	-	
			11082R/L	●		11	0.82	0.41	10.7	2.6	8	4.90	-	-	
			11122R/L	●		11	1.22	0.61	10.7	2.6	8	4.90	-	-	
			11182R/L	●		11	1.82	0.91	10.7	2.6	8	4.90	-	-	
			11202R/L	●		11	2.02	1.01	10.7	2.6	8	4.90	-	-	
			11302R/L	●		11	3.02	1.51	10.7	2.6	8	4.90	-	-	
			14122R/L	●		14	1.22	0.61	13.5	4.3	9	5.85	-	-	
			14182R/L	●		14	1.82	0.91	13.5	4.3	9	5.85	-	-	
			14202R/L	●		14	2.02	1.01	13.5	4.3	9	5.85	-	-	
			14222R/L	●		14	2.22	1.11	13.5	4.3	9	5.85	-	-	
			14302R/L	●		14	3.02	1.51	13.5	4.3	9	5.85	-	-	
			16182R/L	●		16	1.82	0.91	15.7	4.6	11	5.80	-	-	
			16222R/L	●		16	2.22	1.11	15.7	4.6	11	5.80	-	-	
			16302R/L	●		16	3.02	1.51	15.7	4.6	11	5.80	-	-	
			16402R/L	●		16	4.02	2.01	15.7	4.6	11	5.80	-	-	

●: Stock item

● Fine tools



Holders

NFTIH

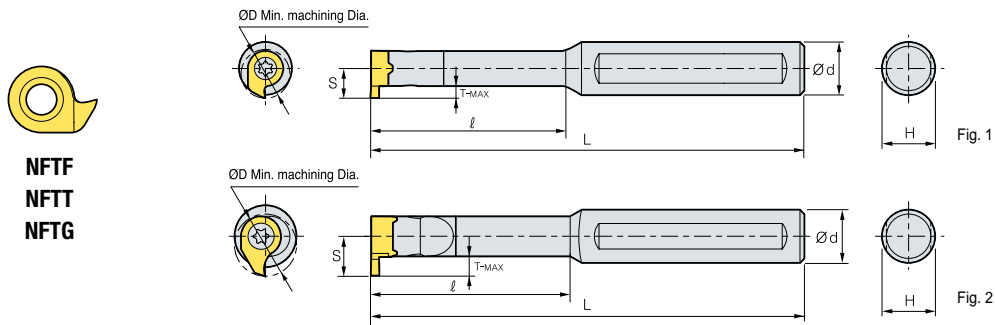
- For NFTIH14-.
- R type insert



(mm)

Designation	Dimensions (mm)							Insert NFTG: Grooving NFTT: Threading NFTF: Forming	Screw 	Wrench 	Fig.
	ØD	Ød	L	ℓ	T-MAX	H	S				
NFTIH 08206C	8	6	65	-	1.0	4	4.8	NFTG08□□□R/L NFTT08□□□R/L NFTF08□□□R/L	PTKA02508	TW08P	1
08212C	8	12	70	16	1.0	10	4.8				
08312C	8	12	80	24	1.0	10	4.8				
08312S	8	12	80	24	1.0	10	4.8				
08412C	8	12	90	32	1.0	10	4.8				
08512C	8	12	100	40	1.0	10	4.8				
11208C	11	8	80	-	2.3	7	6.7	NFTG11□□□R/L NFTT11□□□R/L NFTF11□□□R/L	PTKA03510	TW15P	2
11212C	11	12	75	22	2.3	11	6.7				
11312C	11	12	95	33	2.3	11	6.7				
11312S	11	12	95	33	2.3	11	6.7				
11412C	11	12	110	44	2.3	11	6.7				
11512C	11	12	120	55	2.3	11	6.7				
14012C	14	12	75	20	4.0	11	9.0	NFTG14□□□R/L NFTT14□□□R/L NFTF14□□□R/L	PTKA0412	TW15P	2
14016C	14	16	75	20	4.0	15	9.0				
14112C	14	12	100	34	4.0	11	9.0				
14116C	14	16	100	34	4.0	15	9.0				
14212C	14	12	110	45	4.0	11	9.0				
14216C	14	16	110	45	4.0	15	9.0				
14312C	14	12	130	64	4.0	11	9.0	NFTG16□□□R/L NFTT16□□□R/L NFTF16□□□R/L	PTKA0512	TW20P	2
14316C	14	16	130	64	4.0	15	9.0				
16312C	16	12	130	48	4.3	11	10.2				
16312S	16	12	130	48	4.3	11	10.2				
16412C	16	12	130	64	4.3	11	10.2				
16512C	16	12	150	80	4.3	11	10.2				
16316C	16	16	130	48	4.3	15	10.2				
16416C	16	16	130	64	4.3	15	10.2				
16516C	16	16	150	80	4.3	15	10.2				



ESD Plus

Features

- Economical solid drill
- Highly efficient hole machining for various workpieces including automotive components
- Great value for budget excellent performance and cost efficiency
- Increased wear resistance strong wear resistance due to our new PC325U grade

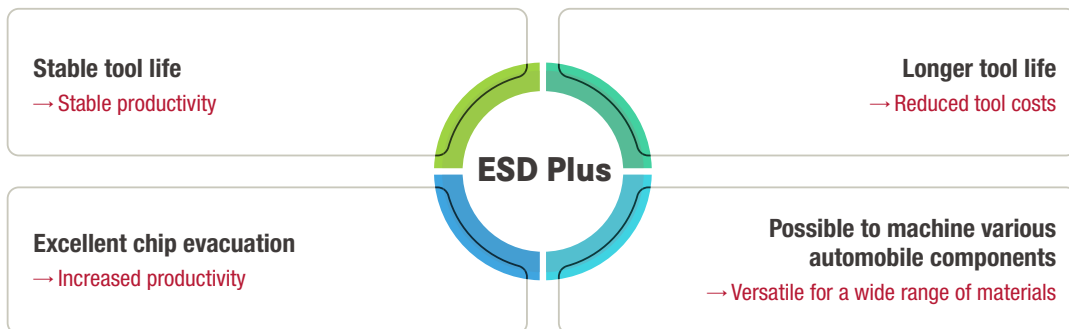

Code system

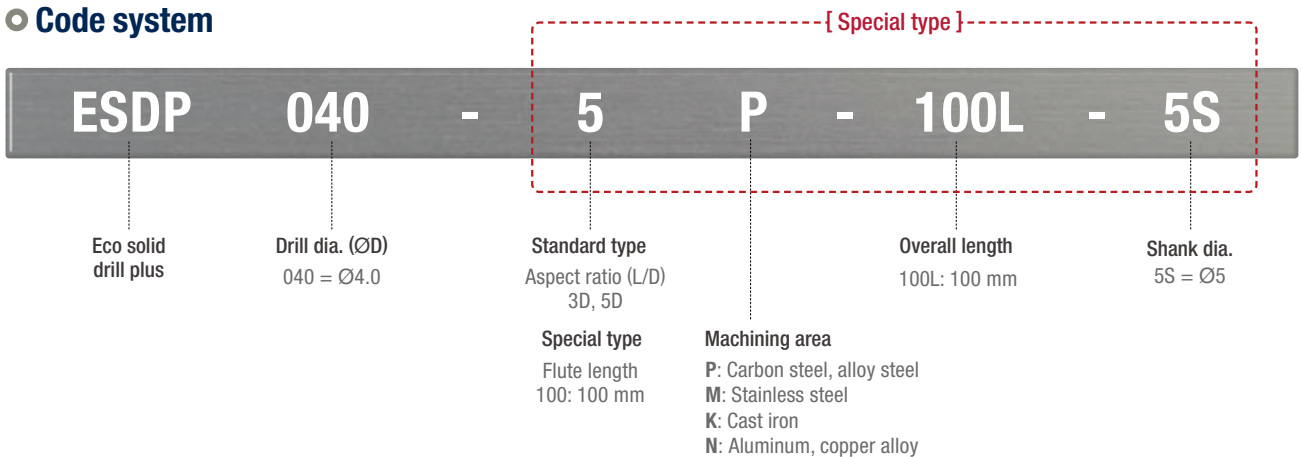

Features

New grade (PC325U)

- Lubricative coating layer improves welding resistance at middle to high speed.
- Increase wear resistance in machining carbon steel
- ▶ Increased welding resistance and wear resistance with new PC325U grade applied.

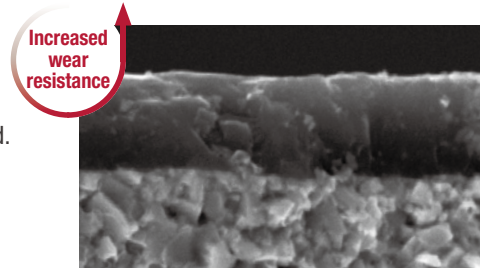

[PC325U]

Application area

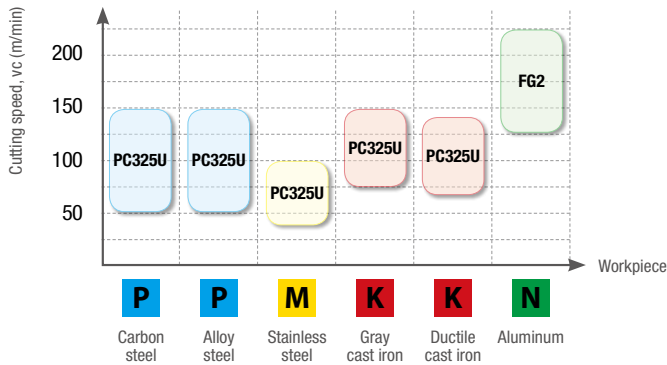

Flute shape

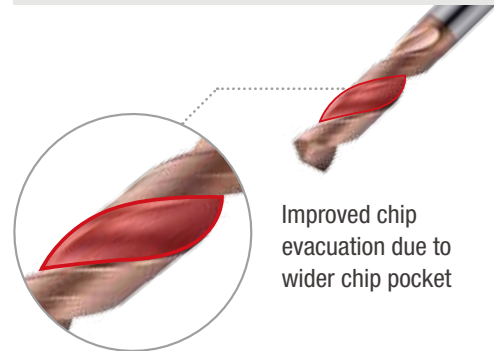

Recommended cutting conditions

	Workpiece	Hardness (HB)	Grade	Cutting speed vc (m/min)	Depth of cut = 10D~25D		
					Feed rate (mm/rev) Per drill dia. (mm)		
					Ø1.0~4.0	Ø4.1~6.0	
P	Carbon steel	Low carbon steel	80~120	PC325U	72 (64~120)	0.08~0.12	0.13~0.19
		High carbon steel	Over 250	PC325U	40 (32~64)	0.06~0.16	0.06~0.16
	Alloy steel	Low alloy steel	140~260	PC325U	72 (64~120)	0.08~0.12	0.13~0.19
		Hardened low alloy steel	200~400	PC325U	48 (40~80)	0.08~0.12	0.13~0.19
		High alloy steel	50~260	PC325U	40 (32~64)	0.06~0.16	0.06~0.16
		Hardened high alloy steel	Over 250	PC325U	40 (32~64)	0.06~0.16	0.06~0.16
M	Stainless steel	Austenite series	135~275	PC325U	36 (20~64)	0.04~0.16	0.04~0.16
		Ferrite series Martensite series	135~275	PC325U	40 (24~64)	0.04~0.16	0.04~0.16
K	Cast iron	Gray cast iron	150~230	PC325U	80 (64~120)	0.08~0.12	0.13~0.19
		Ductile cast iron	160~260	PC325U	72 (56~112)	0.08~0.12	0.13~0.19
N	Aluminum	Aluminum alloy	30~150	FG2	120 (100~176)	0.19~0.30	0.30~0.42
	Copper alloy	Copper alloy	150~160	FG2	120 (100~176)	0.08~0.12	0.13~0.19

* Cutting conditions above are for the case of less than 5D depth of cut and external coolant system applied.



ESD Plus cutting performance

Chip control

• **Workpiece:** 42CrMo4 • **Tools:** ESDP060-5P

[Cutting conditions] • **vc** = 40 m/min • **fn** = 0.1 mm/rev • **ap** = 30 mm, wet

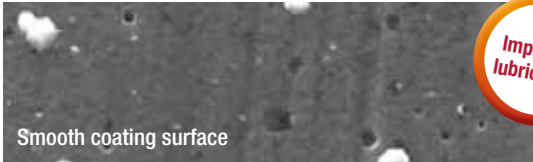
ESD Plus	Competitor
 <p style="text-align: center;">Chips in good shape</p>	
 <p style="text-align: center;">Smooth coating surface</p> <p style="text-align: center;">[ESD Plus]</p>	 <p style="text-align: center;">Rough coating surface</p> <p style="text-align: center;">[Competitor]</p>



► PC325U has a coating surface more lubricated compared to competitor's rough surface.

- Excellent welding resistance and lower cutting load
- Reduced frictional resistance at cutting edges and on the flute

Performance evaluation

Comparison of wear

• **Workpiece:** 42CrMo4 • **Tools:** ESDP060-5P [Cutting conditions] • **vc** = 95 m/min • **fn** = 0.12 mm/rev • **ap** = 20 mm, External coolant

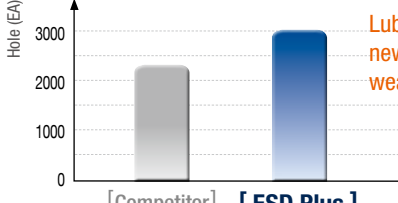
 <p style="text-align: center;">[Competitor]</p>	 <p style="text-align: center;">[ESD Plus]</p>	 <p style="text-align: center;">[Competitor] [ESD Plus]</p> <p style="color: orange;">Lubricative coating layer of the new grade PC325U maximizes wear resistance.</p>
--	--	---

Application example

• **Workpiece:** C45 • **Tools:** ESDP090-5P [Cutting conditions] • **vc** = 50 m/min • **fn** = 0.08 mm/rev • **ap** = 23.5 mm, External coolant

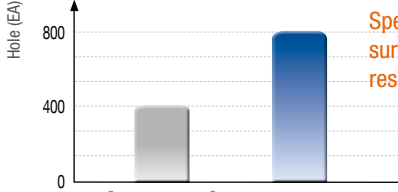
	 <p style="text-align: center;">[Competitor] [ESD Plus]</p> <p style="color: orange;">Special treatment on coating surface minimizes frictional resistance.</p>
---	--

ESD Plus

Holders

ESDP - 5P

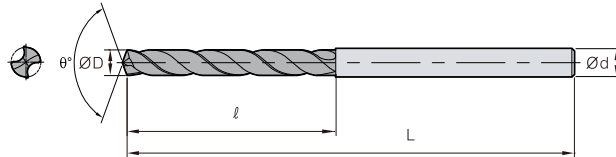

Terminology	P	M	K	N
Grade	PC325U	FG2		
Tolerance (Drill dia.)	h7			
Tolerance (Shank dia.)	h6			
Point angle (θ°)	140°	135°		
Twist angle	30°			
Thinning	X type			
Coolant	External			

■ Steel
 ■ Stainless steel
 ■ Cast iron
 ■ Non-ferrous metal

(mm)

Designation	Coated	Uncoated	Dimensions (mm)			
	PC325U	FG2	ØD	Ød	L	ℓ
ESDP 010-5P	●		1.00	3	8	45
0105-5P	●		1.05	3	8	45
011-5P	●		1.10	3	9	45
0115-5P	●		1.15	3	9	45
012-5P	●		1.20	3	10	45
0125-5P	●		1.25	3	10	45
013-5P	●		1.30	3	10	45
0135-5P	●		1.35	3	10	45
014-5P	●		1.40	3	11	45
0145-5P	●		1.45	3	11	45
015-5P	●		1.50	3	11	45
0155-5P	●		1.55	3	11	45
016-5P	●		1.60	3	12	45
0165-5P	●		1.65	3	12	45
017-5P	●		1.70	3	12	45
0175-5P	●		1.75	3	12	45
018-5P	●		1.80	3	13	45
0185-5P	●		1.85	3	13	45
019-5P	●		1.90	3	14	45
0195-5P	●		1.95	3	14	45
020-5P	●		2.00	3	18	50
0205-5P	●		2.05	3	18	50
021-5P	●		2.10	3	18	50
0215-5P	●		2.15	3	18	50
022-5P	●		2.20	3	18	50
0225-5P	●		2.25	3	18	50
023-5P	●		2.30	3	18	50
0235-5P	●		2.35	3	18	50
024-5P	●		2.40	3	18	50
0245-5P	●		2.45	3	18	50
025-5P	●		2.50	3	18	50
0255-5P	●		2.55	3	18	50
026-5P	●		2.60	3	18	50
0265-5P	●		2.65	3	18	50

Designation	Coated	Uncoated	Dimensions (mm)			
	PC325U	FG2	ØD	Ød	L	ℓ
ESDP 027-5P	●		2.70	3	18	50
0275-5P	●		2.75	3	18	50
028-5P	●		2.80	3	18	50
0285-5P	●		2.85	3	18	50
029-5P	●		2.90	3	18	50
0295-5P	●		2.95	3	18	50
030-5P	●		3.00	3	20	55
0305-5P	●		3.05	4	20	55
031-5P	●		3.10	4	20	55
0315-5P	●		3.15	4	20	55
032-5P	●		3.20	4	20	55
0325-5P	●		3.25	4	20	55
033-5P	●		3.30	4	20	55
0335-5P	●		3.35	4	20	55
034-5P	●		3.40	4	20	55
0345-5P	●		3.45	4	20	55
035-5P	●		3.50	4	20	55
0355-5P	●		3.55	4	20	55
036-5P	●		3.60	4	25	55
0365-5P	●		3.65	4	25	55
037-5P	●		3.70	4	25	55
0375-5P	●		3.75	4	25	55
038-5P	●		3.80	4	25	55
0385-5P	●		3.85	4	25	55
039-5P	●		3.90	4	25	55
0395-5P	●		3.95	4	25	55
040-5P	●		4.00	4	25	55
0405-5P	●		4.05	5	25	55
041-5P	●		4.10	5	25	55
0415-5P	●		4.15	5	33	55
042-5P	●		4.20	5	33	63
0425-5P	●		4.25	5	33	63
043-5P	●		4.30	5	33	63
0435-5P	●		4.35	5	33	63



Holders

ESDP - 5P

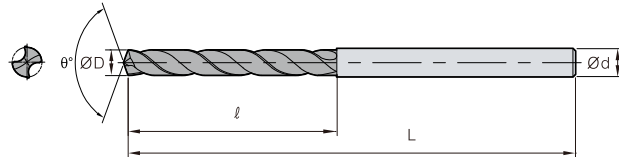

Terminology	P	M	K	N
Grade	PC325U		FG2	
Tolerance (Drill dia.)	h7			
Tolerance (Shank dia.)	h6			
Point angle (θ°)	140°		135°	
Twist angle	30°			
Thinning	X type			
Coolant	External			

Steel Stainless steel Cast iron Non-ferrous metal

(mm)

Designation	Coated	Uncoated	Dimensions (mm)			
	PC325U	FG2	ØD	Ød	L	ℓ
ESDP 044-5P	●		4.40	5	33	63
0445-5P	●		4.45	5	33	63
045-5P	●		4.50	5	33	63
0455-5P	●		4.55	5	33	63
046-5P	●		4.60	5	33	63
0465-5P	●		4.65	5	33	63
047-5P	●		4.70	5	33	63
0475-5P	●		4.75	5	33	63
048-5P	●		4.80	5	33	63
0485-5P	●		4.85	5	33	63
049-5P	●		4.90	5	33	63
0495-5P	●		4.95	5	33	63

Designation	Coated	Uncoated	Dimensions (mm)			
	PC325U	FG2	ØD	Ød	L	ℓ
ESDP 050-5P	●		5.00	5	33	63
051-5P	●		5.10	6	33	63
052-5P	●		5.20	6	36	66
053-5P	●		5.30	6	36	66
054-5P	●		5.40	6	36	66
055-5P	●		5.50	6	36	66
056-5P	●		5.60	6	36	66
057-5P	●		5.70	6	36	66
058-5P	●		5.80	6	36	66
059-5P	●		5.90	6	36	66
060-5P	●		6.00	6	36	66

www.korloy.com

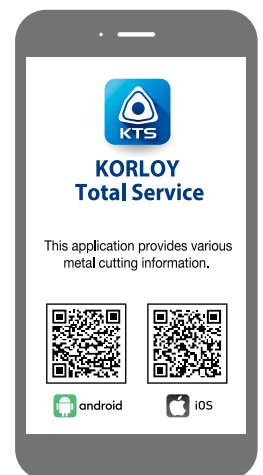

Holystar B/D, 1350, Nambusunhwan-ro, Geumcheon-gu, Seoul, 08536, Korea
Tel: +82-2-522-3181 Fax: +82-2-522-3184, +82-2-3474-4744 Web: www.korloy.com E-mail: sales.khq@korloy.com

KORLOY AMERICA

620 Maple Avenue, Torrance, CA 90503, USA
Tel: +1-310-782-3800 Toll Free: +1-888-711-0001 Fax: +1-310-782-3885
E-mail: sales.kai@korloy.com

KORLOY INDIA

Plot No. 415, Sector 8, IMT Manesar, Gurgaon 122051, Haryana, India
Tel: +91-124-4391790 Fax: +91-124-4050032
E-mail: sales.kip@korloy.com

KORLOY TURKEY

Serifali Mahallesi, Burhan Sokak NO: 34
Dudullu OSB/Umraniye/Istanbul, 34775, Turkey
Tel: +90-216-415-8874 E-mail: sales.ktl@korloy.com

KORLOY RUSSIA

Krasivy Dom office No. 305, Bld. 5, Novovladykinskiy proezd 8, 127106,
Moscow, Russia
Tel: +7-495-280-1458 Fax: +7-495-280-1459 E-mail: sales.krc@korloy.com

KORLOY FACTORY QINGDAO

Ground Dongjing Road 56(B) District Free Trade Zone. Qingdao, China
Tel: +86-532-86959880 Fax: +86-532-86760651
E-mail: pro.kfq@korloy.com

KORLOY EUROPE

Gablونzer Str. 25-27, 61440 Oberursel, Germany
Tel: +49-6171-277-83-0 Fax: +49-6171-277-83-59
E-mail: sales.keg@korloy.com

KORLOY BRASIL

Av. Aruana 280, conj.12, WLC, Alphaville, Barueri,
CEP06460-010, SP, Brasil
Tel: +55-11-4193-3810 E-mail: sales.kbl@korloy.com

KORLOY CHILE

Av. Providencia 1650, Office 1009, 7500027
Providencia-Santiago, Chile
Tel: +56-229-295-490 E-mail: sales.kcs@korloy.com

KORLOY MEXICO

Queretaro, Mexico
E-mail: sales.kml@korloy.com

KORLOY FACTORY INDIA

Plot No. 415, Sector 8, IMT Manesar, Gurgaon 122051, Haryana, India
Tel: +91-124-4391790 Fax: +91-124-4050032
E-mail: pro.kim@korloy.com